

Ferramentas para torneamento

TORNEAMENTO GERAL
CORTES E CANAIS
TORNEAMENTO DE ROSCA
FERRAMENTAS MULTIFUNÇÃO
SISTEMAS DE FIXAÇÃO
ADAPTADORES PARA FERRAMENTAS DE TORNEAMENTO

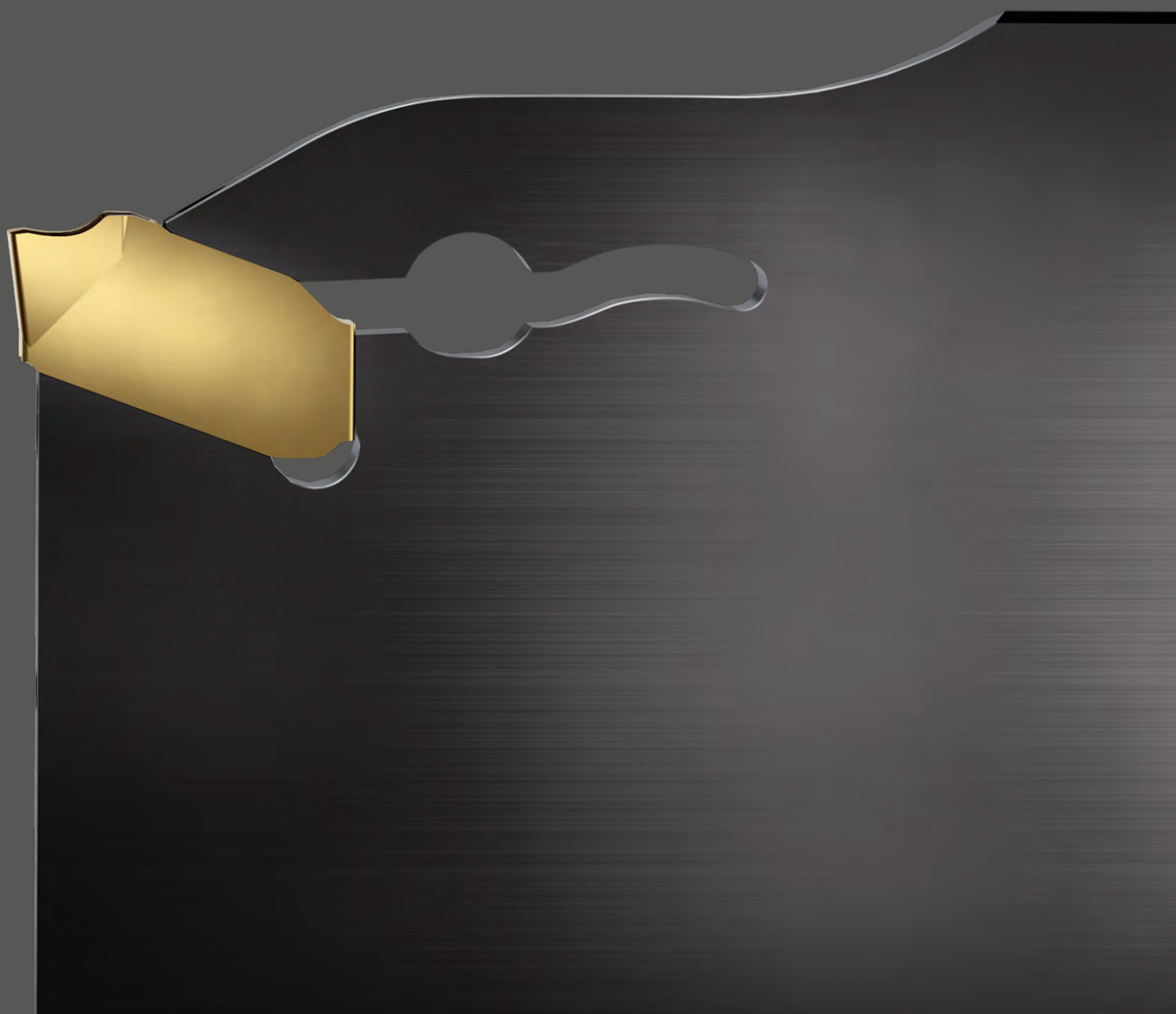



Vamos introduzir nossos novos catálogos

O catálogo consiste em três volumes: Ferramentas para Torneamento, Ferramentas Rotativas e Ferramentas Sólidas Rotativas. No total, mais de 30.000 produtos standard foram lançados.

Ferramentas para Torneamento – Torneamento geral, Cortes e canais, Torneamento de roscas, Ferramentas multifunção, Sistemas de fixação de ferramentas e Adaptadores para ferramentas de torneamento

Ferramentas Rotativas – Fresamento, Furação, Mandrilamento e Adaptadores para ferramentas rotativas

Ferramentas Sólidas Rotativas – Fresamento, Furação, Rosqueamento com macho e Alargamento

Use as visões gerais dos produtos no início de cada capítulo para encontrar sua área de interesse e uma referência levará você para a página do produto. As referências visuais no final de cada página do produto irão guiá-lo para mais informações e os produtos relacionados, como suportes, pastilhas e dados de corte.

Nossa oferta total com aproximadamente 50.000 produtos standard que podem ser encontrados em :

www.sandvik.coromant.com. Se você não encontrar o que precisa, temos uma ampla gama de produtos que podem ser personalizados mediante sua solicitação.

Visite www.sandvik.coromant.com para obter as últimas medidas e tolerâncias, dados de corte detalhados e solicitar todos os produtos e componentes disponíveis.



Explicação sobre os símbolos de referência:



Pastilhas



Ferramentas externas



Ferramentas internas



Adaptadores



Suportes



Adaptadores CoroTurn® SL



Acessórios



Dados de corte



Descrição da classe



Descrição da geometria



Explicação sobre parâmetros



Tailor Made



Chave de código



Informações sobre refrigeração



Informação



Primeira escolha

Boa escolha

Não disponível

Nossa recomendação de primeira escolha é um bom ponto de partida para a maioria das operações, pois você pode escolher uma classe com outras características, se necessário.

- A Torneamento geral
- B Cortes e canais
- C Torneamento de rosca
- D Ferramentas multifunção
- E Sistemas de fixação
- F Adaptadores para ferramentas de torneamento
- G Acessórios
- H Informações gerais

Torneamento geral

CoroTurn® Prime A3

Pastilhas A4
Ferramentas externas A5-A13
Ferramentas internas A14-A15

CoroTurn® 300 A16

Pastilhas A17
Ferramentas externas A18-A19

CoroTurn® TR A20

Pastilhas A21-A22
Ferramentas externas A23-A33
Ferramentas internas A34-A38

CoroTurn® 107 A39

Pastilhas A40-A57
Ferramentas externas A58-A87
Ferramentas internas A88-A150

T-Max® P A151

Pastilhas A152-A176
Ferramentas externas A177-A216
Ferramentas internas A217-A241

T-Max® e T-Max® S A242

Pastilhas A243-A250
Ferramentas externas A251-A261
Ferramentas internas A268-A269

CoroTurn® XS A270

Ferramentas de corte A271-A275
Adaptadores F2

CoroCut® XS A276

Pastilhas A277
Ferramentas externas B99-B100

CoroTurn® 111 Web

www.sandvik.coromant.com/coroturn111

CoroCut® MB Web

www.sandvik.coromant.com/corocutmb

	Aplicação		Operação	Material de corte				Tamanho do diâmetro recomendado	
	Externa	Interna		Metal duro	Cerâmica	CBN	PCD		
B									
	CoroTurn® Prime	X	X	Desbaste ao acabamento	X				Ø>40 mm
C	CoroTurn® 300	X		Usinagem média ao acabamento	X				
	CoroTurn® TR	X	X	Usinagem média ao acabamento	X		X		Ø>35 mm
D	CoroTurn® 107	X	X	Usinagem média ao acabamento	X		X	X	Ø6-80 mm
	T-Max® P	X	X	Desbaste ao acabamento	X	X	X		Ø>50 mm
E	T-Max®	X	X	Desbaste ao acabamento		X	X	X	Ø>32 mm
	T-Max® S	X		Desbaste ao acabamento		X	X	X	
F	CoroTurn® XS		X	Acabamento	X		X		Ø0,3-10 mm
	CoroCut® XS	X		Acabamento	X				
G									
H									

CoroTurn® Prime

Introdução de um método totalmente novo de torneamento

Aplicação

- Desbaste
- Acabamento
- Perfilamento

Área de aplicação ISO:



Características e benefícios

- Dados de corte mais altos proporcionam maior saída de peças e custo reduzido por peça
- O controle de cavacos e a vida útil mais longa da ferramenta propiciam maior segurança na produção
- A redução da temperatura na aresta de corte significa melhor vida útil da ferramenta



www.sandvik.coromant.com/coroturnprime

Tipo-A

- Versátil e flexível - para desbaste leve, acabamento e perfilamento
- Três cantos a 35°
- Wiper (08) para excelente acabamento superficial
- Classes disponíveis: GC4325, GC2025, GC1115, H13A



Tipo B

- Pastilha mais robusta para usinagem em desbaste
- Dois cantos
- Wiper para excelente acabamento superficial
- Classes disponíveis: GC4325, GC2025, GC1115, H13A



Pastilhas

Tipo-A	Tipo B
A4	A4

Ferramentas

Unidade de corte Coromant Capto	Ferramentas convencionais	Ferramenta convencional QS™	Cabeças de corte CoroTurn® SL
A5-A9	A10-A11	A12-A13	A14-A15

A

Pastilha CoroTurn® Prime para torneamento

Pastilha tipo A

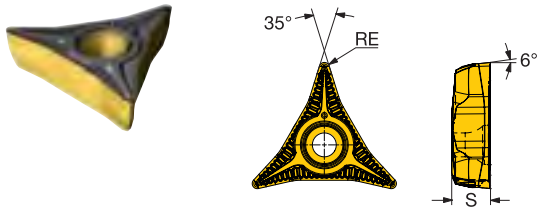

B

C

Acabamento	SSC	S	RE	CÓDIGO ISO	P		M		K		S	
					4325	H13A	1115	2025	H13A	4325	1115	H13A
L5	CP-A	6.00	0.40	CP-A1104-L5	★	☆	★	★	★	★		
		6.00	0.79	CP-A1108-L5	★	☆	★	★	★	★		
L5W	CP-A	6.00	0.79	CP-A1108-L5W	★	☆	★	★	★	★		
L3	CP-A	6.00	0.79	CP-A1108-L3	★	☆	★	☆	★	★	☆	
L3WX	CP-A	6.00	0.79	CP-A1108-L3WX	★							

D

Pastilha tipo B

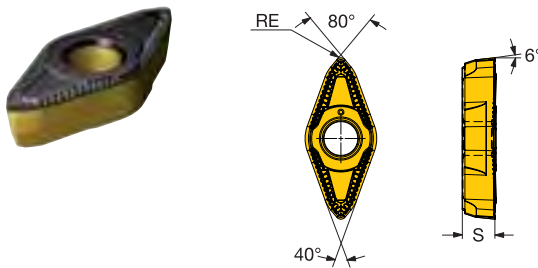

E

Acabamento	SSC	S	RE	CÓDIGO ISO	P		M		K		S	
					4325	H13A	1115	2025	H13A	4325	H13A	1115
L4	CP-B	5.00	0.79	CP-B1108-L4	★	☆	★	☆	★	★	★	☆
		5.00	0.79	CP-B1108-L4W	★	☆	★	☆	★	★	★	☆
L4W	CP-B	5.00	0.79	CP-B1108-L4W	★	☆	★	☆	★	★	★	☆
Média	M5	CP-B	5.00	0.79	CP-B1108-M5	★	☆	★	★	★	★	★
	M5W	CP-B	5.00	0.79	CP-B1108-M5W	★	☆	★	★	★	★	★
	H3W	CP-B	5.00	0.79	CP-B1108-H3W	★	☆	★	☆	★	★	☆
	H3	CP-B	5.00	0.79	CP-B1108-H3	★	☆	★	☆	★	★	☆

SSC = Para corresponder ao SSC no suporte.

G

H



Unidade de corte CoroTurn® Prime para torneamento

Fixação por parafuso

Coromant Capto® - Refrigeração de precisão

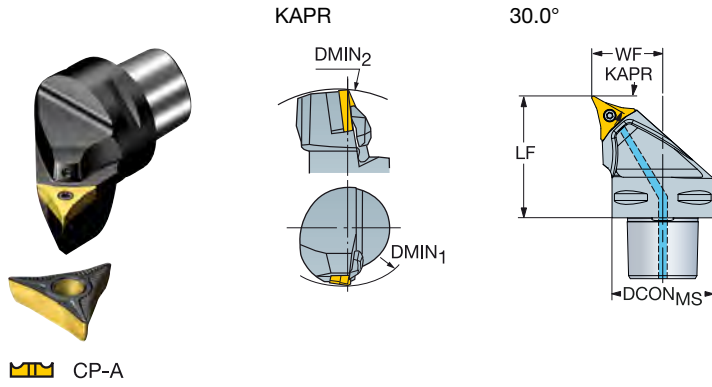

SSC	CZC _{MS}	DMIN ₁	DMIN ₂	RMPX	CNCS	Código para pedido	Dimensões, mm						MIID	
							DCON _{MS}	LF	WF	BAR	NM	KG		
	CP-A	C4	95.0	145.0	15°	3	C4-CP-30AR/L-27050-11C	40.0	50.0	27.0	150	3.0	0.47	CP-A1108
		C5	95.0	165.0	15°	3	C5-CP-30AR/L-35060-11C	50.0	60.0	35.0	150	3.0	0.79	CP-A1108
		C6	115.0	190.0	15°	3	C6-CP-30AR/L-45065-11C	63.0	65.0	45.0	150	3.0	1.25	CP-A1108

SSC = Para corresponder ao SSC na pastilha.

R = versão direita, L = versão esquerda

Componentes					
SSC	CZC _{MS}	Parafuso da pastilha	Olhal	Parafuso do plugue de vedação	Parafuso para refrigeração
CP-A	C4-C6	5513 020-01	5691 026-03	3214 013-03	3213 010-256

Para a lista completa de componentes, acesse www.sandvik.coromant.com



A

Unidade de corte CoroTurn® Prime para torneamento

Fixação por parafuso

Coromant Capto® - Refrigeração de precisão

B

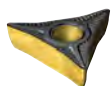

CP-A

KAPR

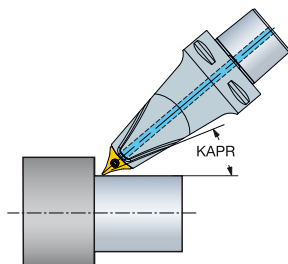

30.0°

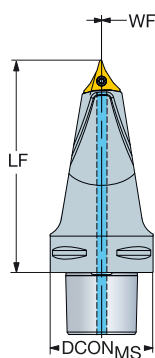

C

						Dimensões, mm						
SSC	CZC _{MS}	RMPX	CNSC	Código para pedido		DCON _{MS}	LF	WF	BAR	NM	KG	MIID
CP-A	C5	15°	3	C5-CP-75AL00115-11C		50.0	115.0	0.0	150	3.0	1.20	CP-A1108
	C6	15°	3	C6-CP-75AL00130-11C		63.0	130.0	0.0	150	3.0	0.00	CP-A1108
	C8	15°	3	C8-CP-75AL00160-11C		80.0	160.0	0.0	150	3.0	4.20	CP-A1108

D

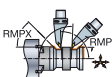

E



CP-A

KAPR

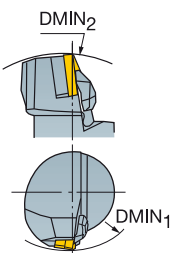

30.0°

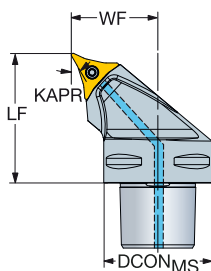

						Dimensões, mm								
SSC	CZC _{MS}	DMIN ₁	DMIN ₂	RMPX	CNSC	Código para pedido		DCON _{MS}	LF	WF	BAR	NM	KG	MIID
CP-A	C5	110.0	780.0	15°	3	C5-CP-A-30AR/L40060-11C		50.0	60.0	40.0	150	3.0	0.68	CP-A1108
	C6	110.0	900.0	15°	3	C6-CP-A-30AR/L50065-11C		63.0	65.0	50.0	150	3.0	1.17	CP-A1108

R = versão direita, L = versão esquerda

G

Componentes		
Parafuso da pastilha	Olhal	Parafuso para refrigeração
5513 020-10	5691 026-03	3213 010-256

Para a lista completa de componentes, acesse www.sandvik.coromant.com

H



A4



F2



E1



G1



H36



H14



H5

Unidade de corte CoroTurn® Prime para torneamento

Fixação rígida

Coromant Capto® - Refrigeração de precisão

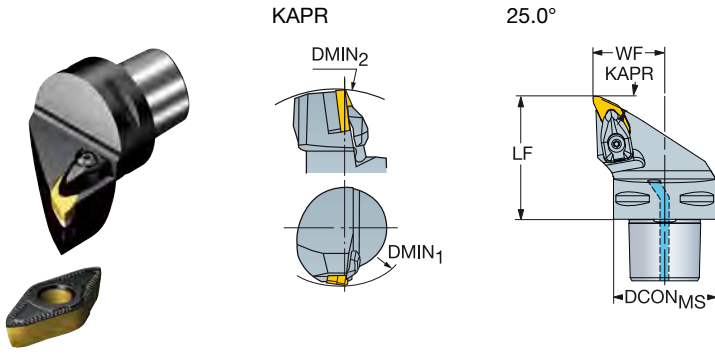

CP-B

							Dimensões, mm							MIID
	SSC	CZC _{MS}	DMIN ₁	DMIN ₂	RMPX	CNSC	Código para pedido	DCON _{MS}	LF	WF	BAR	NM	KG	
	CP-B	C4	240.0	260.0	23°	3	C4-CP-25BR/L-27060-11B	40.0	60.0	27.0	150	3.0	0.51	CP-B1108
		C5			23°	3	C5-CP-25BR/L-35060-11B	50.0	60.0	35.0	150	3.0	0.71	CP-B1108
		C6	340.0	280.0	23°	3	C6-CP-25BR/L-45065-11B	63.0	65.0	45.0	150	3.0	1.21	CP-B1108

SSC = Para corresponder ao SSC na pastilha.

R = versão direita, L = versão esquerda

Componentes		
Parafuso do calço	Calço	Jogo de fixação
5513 020-04	5322 610-01 S6	5412 028-021

Para a lista completa de componentes, acesse www.sandvik.coromant.com



A

Unidade de corte CoroTurn® Prime para torneamento

Fixação rígida

Coromant Capto® - Refrigeração de precisão

B



KAPR

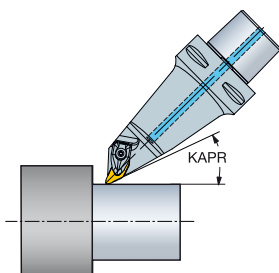

25.0°

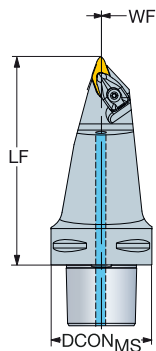

C

CP-B

						Dimensões, mm						
SSC	CZC _{MS}	RMPX	CNSC	Código para pedido		DCON _{MS}	LF	WF	BAR	NM	KG	MIID
	CP-B	C5	23°	3	C5-CP-70BL00115-11B	50.0	115.0	0.0	150	3.0	1.15	CP-B1108
		C6	23°	3	C6-CP-70BL00130-11B	63.0	130.0	0.0	150	3.0	1.97	CP-B1108
		C8	23°	3	C8-CP-70BL00160-11B	80.0	160.0	0.0	150	3.0	4.13	CP-B1108

D

E

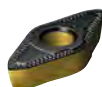

KAPR

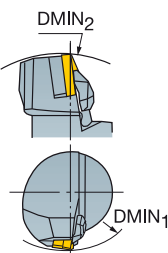

25.0°

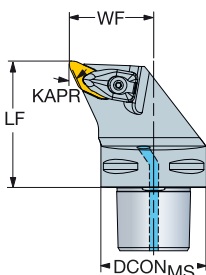

CP-B

						Dimensões, mm								
SSC	CZC _{MS}	DMIN ₁	DMIN ₂	RMPX	CNSC	Código para pedido	DCON _{MS}	LF	WF	BAR	NM	KG	MIID	
	CP-B	C5	140.0	150.0	23°	3	C5-CP-A-25BR/L40060-11B	50.0	60.0	40.0	150	3.0	0.67	CP-B1108
		C6	150.0	150.0	23°	3	C6-CP-A-25BR/L50065-11B	63.0	65.0	50.0	150	3.0	1.21	CP-B1108

R = versão direita, L = versão esquerda

G

Componentes

Parafuso do calço	Calço	Jogo de fixação	Parafuso para refrigeração
5513 020-04	5322 610-01	S6 5412 028-021	3213 010-256

Para a lista completa de componentes, acesse www.sandvik.coromant.com

H



A4



F2



E1



G1



H36



H14



H5

Unidade de corte CoroTurn® Prime para torneamento

Ferramenta conjugada

Coromant Capto® - Refrigeração de precisão

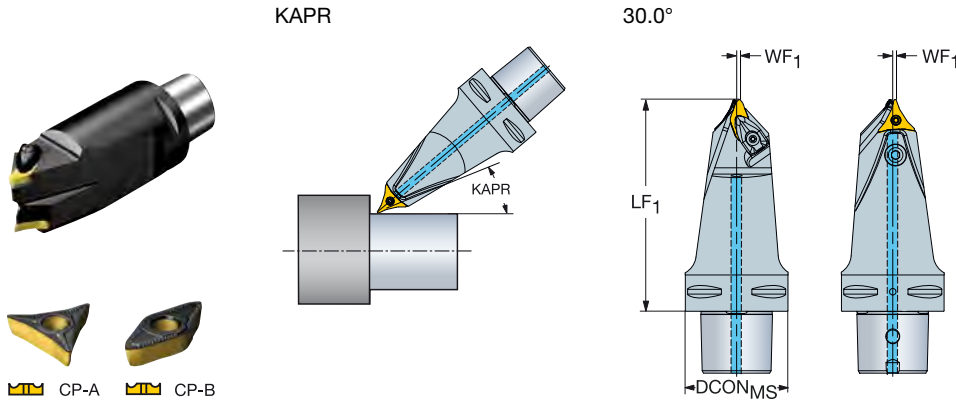

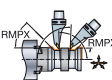
						Dimensões, mm, pol.								
SSC	CZC _{MS}	RMPX	OHX	CNSC	Código para pedido	DCON _{MS}	LF ₁	WF ₁	HF	BAR FSI	NM	KG	MID	
	CP-A	C6	15°	130.0	3	C6-T-A11B11L-130	63	130.0	2.0	20.0	80	3.0	2.28	CP-A1108
	CP-B	C6	23°	130.0	3		63	130.0	2.0	20.0	80	3.0	2.28	CP-B1108
	CP-A	C8	15°	160.0	3	C8-T-A11B11L-160	80	160.0	2.0	25.0	80	3.0	4.60	CP-A1108
	CP-B	C8	23°	160.0	3		80	160.0	2.0	25.0	80	3.0	4.60	CP-B1108

Componentes

Parafuso da pastilha	Parafuso do calço	Calço	Jogo de fixação	Olhal	Parafuso para refrigeração	
5513 020-10	5513 020-04	5322 610-01	S6	5412 028-021	5691 026-03	5512 104-01

Para a lista completa de componentes, acesse www.sandvik.coromant.com



A

Ferramenta com haste convencional CoroTurn® Prime para torneamento

Fixação rígida

KAPR

25.0°

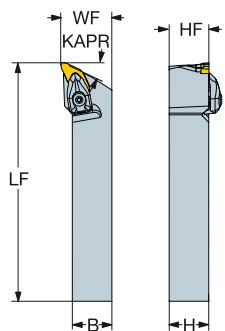

C

CP-B

						Dimensões, mm							MID	
	SSC	CZC _{MS}	RMPX	OHX	OHN	Código para pedido	B	H	LF	WF	HF	NM		KG
	CP-B	20 x 20	23°	40.0	37.9	CP-25BR/L-2020-11	20.0	20.0	125.0	25.0	20.0	3.0	0.43	CP-B1108
		25 x 25	23°	50.0	37.5	CP-25BR/L-2525-11	25.0	25.0	150.0	32.0	25.0	3.0	0.75	CP-B1108
		32 x 32	23°	64.0	37.3	CP-25BR/L-3232-11	32.0	32.0	170.0	40.0	32.0	3.0	1.37	CP-B1108

D

SSC = Para corresponder ao SSC na pastilha.

R = versão direita, L = versão esquerda

Componentes

Parafuso do calço	Calço	Jogo de fixação
5513 020-04	5322 610-01 S6	5412 028-021

Para a lista completa de componentes, acesse www.sandvik.coromant.com

E

F

G

H



A4



F2



E1



H36



H14

Ferramenta com haste convencional CoroTurn® Prime para torneamento

Fixação por parafuso

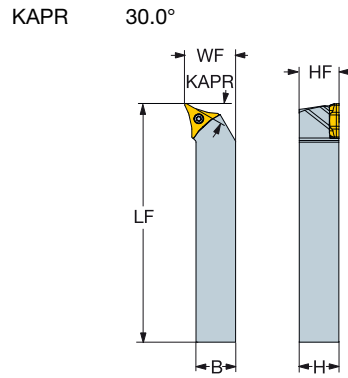
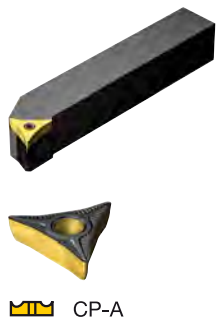

CP-A

SSC	CZC _{MS}	RMPX	OHX	OHN	Código para pedido	Dimensões, mm						MIID	
						B	H	LF	WF	HF	NM		KG
CP-A	20 x 20	15°	40.0	23.7	CP-30AR/L-2020-11	20.0	20.0	125.0	25.0	20.0	3.0	0.43	CP-A1108
	25 x 25	15°	50.0	23.7	CP-30AR/L-2525-11	25.0	25.0	150.0	32.0	25.0	3.0	0.72	CP-A1108
	32 x 32	15°	64.0	23.7	CP-30AR/L-3232-11	32.0	32.0	170.0	40.0	32.0	3.0	1.36	CP-A1108

SSC = Para corresponder ao SSC na pastilha.

R = versão direita, L = versão esquerda

Componentes
Parafuso da pastilha
5513 020-10

Para a lista completa de componentes, acesse www.sandvik.coromant.com



A

TORNEAMENTO GERAL

Ferramentas externas

Ferramenta com haste convencional CoroTurn® Prime QS para torneamento

Fixação rígida

Refrigeração de precisão

B

KAPR 25.0°

C

CP-B

D

Dimensões, mm

SSC	CZC _{MS}	RMPX	OHX	CNSC	Código para pedido	B	H	HBL	LF	WF	HF	CNT	BAR	NM	KG	MIID
CP-B	20 x 20	23°	52.0	3	QS-CP-25BR/L-2020-11B	20.0	20.0	32.0	101.0	25.0	20.0	G 1/8-28	150	3.0	0.32	CP-B1108
	25 x 25	23°	57.0	3	QS-CP-25BR/L-2525-11B	25.0	25.0	32.0	116.0	32.0	25.0	G 1/8-28	150	3.0	0.62	CP-B1108

SSC = Para corresponder ao SSC na pastilha.

R = versão direita, L = versão esquerda

Componentes

Parafuso do calço	Calço	Jogo de fixação	Parafuso para refrigeração	Parafuso do plugue de vedação	Parafuso do plugue de vedação
5513 020-04	5322 610-01 S6	5412 028-021	5512 104-01	3214 013-01	3214 012-01

E

Para a lista completa de componentes, acesse www.sandvik.coromant.com

F

G

H

A4

F2

E1

G1

H36

H14

H5

A 12

Ferramenta com haste convencional CoroTurn® Prime QS para torneamento

Fixação por parafuso

Refrigeração de precisão

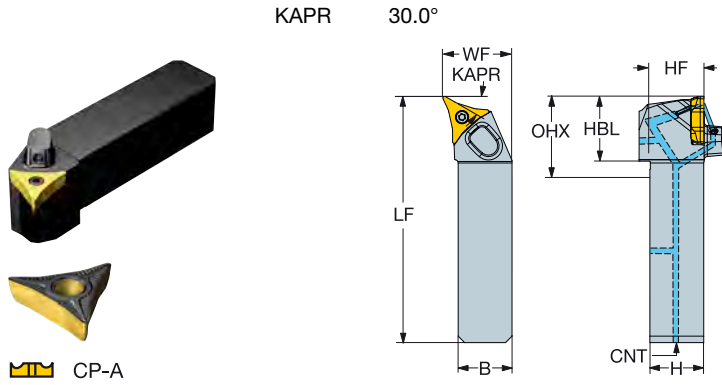

		Dimensões, mm																
		SSC	CZC _{MS}	RMPX	OHX	CNSC	Código para pedido	B	H	HBL	LF	WF	HF	CNT	BAR	NM	KG	MIID
	CP-A	20 x 20	15°	52.0	3	QS-CP-30AR/L-2020-11C	20.0	20.0	32.0	101.0	25.0	20.0	G 1/8-28	150	3.0	0.37	CP-A1108	
		25 x 25	15°	55.0	3	QS-CP-30AR/L-2525-11C	25.0	25.0	32.0	114.1	32.0	25.0	G 1/8-28	150	3.0	0.59	CP-A1108	

SSC = Para corresponder ao SSC na pastilha.

R = versão direita, L = versão esquerda

Componentes				
Parafuso da pastilha	Olhal	Parafuso para refrigeração	Parafuso do plugue de vedação	Parafuso do plugue de vedação
5513 020-10	5691 026-03	5512 104-01	3214 013-01	3214 012-01

Para a lista completa de componentes, acesse www.sandvik.coromant.com



Cabeça CoroTurn® Prime para torneamento

Fixação rígida

CoroTurn® SL - Refrigeração de precisão

KAPR 25.0°

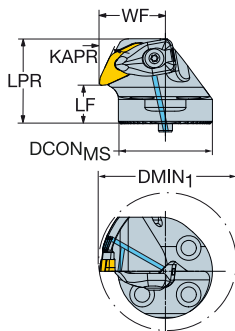

CP-B

		Dimensões, mm											
SSC	CZC _{MS}	DMIN ₁	RMPX	CNSC	Código para pedido	DCON _{MS}	LPR	LF	WF				MIID
CP-B	40	90.0	23°	1	SL-CP-X-25BR/L-40-11B	40.0	36.0	16.0	28.0				CP-B1108
	40	50.0	23°	1	SL-CPX25BR/L-40-11B50	40.0	36.0	16.0	28.0				CP-B1108

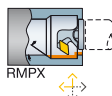

R = versão direita, L = versão esquerda

Componentes				
Parafuso do calço	Calço	Jogo de fixação	Parafuso para refrigeração	Tubo de localização
5513 020-04	5322 610-01	S6 5412 028-021	3213 010-256	5638 031-01

Para a lista completa de componentes, acesse www.sandvik.coromant.com



Cabeça CoroTurn® Prime para torneamento

Fixação por parafuso

CoroTurn® SL - Refrigeração de precisão

KAPR

30.0°

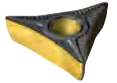

CP-A

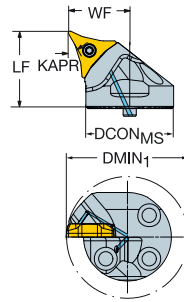

SSC	CZC _{MS}	DMIN ₁	RMPX	CNSC	Código para pedido	Dimensões, mm						MIID		
						DCON _{MS}	LF	WF	BAR	NM	KG			
	CP-A	32	40.0	15°	1	SL-CP-30AR/L-32-11C40	32.0	32.0	22.0	70	3.0	0.10	CP-A1108	
			40	90.0	15°	1	SL-CP-30AR/L-40-11C	40.0	35.0	28.0	70	3.0	0.18	CP-A1108
			40	50.0	15°	1	SL-CP-30AR/L-40-11C50	40.0	35.0	28.0	70	3.0	0.18	CP-A1108

Fixação rígida

KAPR

25.0°



CP-B

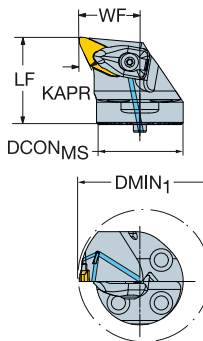

SSC	CZC _{MS}	DMIN ₁	RMPX	CNSC	Código para pedido	Dimensões, mm						MIID	
						DCON _{MS}	LF	WF	BAR	NM	KG		
	CP-B	40	90.0	23°	1	SL-CP-25BR/L-40-11B	40.0	40.0	28.0	70	3.0	0.19	CP-B1108
			40	50.0	23°	1	SL-CP-25BR/L-40-11B50	40.0	40.0	28.0	70	3.0	0.19

R = versão direita, L = versão esquerda

Componentes					
Código para pedido	Parafuso da pastilha	Olhal	Parafuso para refrigeração	Tubo de localização	
SL-CP-30AR/L-40-11C	5513 020-10	5691 026-13	3213 010-256	5638 031-01	
Componentes					
Código para pedido	Parafuso do calço	Calço	Jogo de fixação	Parafuso para refrigeração	Tubo de localização
SL-CP-25BR/L-40-11B	5513 020-04	5322 610-01 S6	5412 028-021	3213 010-256	5638 031-01

Para a lista completa de componentes, acesse www.sandvik.coromant.com



CoroTurn® 300

Para torneamento externo de peças de alta qualidade

Aplicação

- Torneamento longitudinal
- Faceamento
- Operações de usinagem média a acabamento

Área de aplicação ISO:



Características e benefícios

- Pastilhas com oito arestas para assegurar boa transformação ao calor além de desempenho e desgaste previsíveis
- Geometrias com excelente quebra de cavacos dentro de duas respectivas áreas de aplicação
- A interface Coromant Capto® ou as hastes QS™ permitem troca rápida da ferramenta e fácil conexão de refrigeração, o que maximiza o tempo de produção.
- Pastilhas nas classes de aços GC4325 e GC4315 com Inveio™ - para alta resistência ao desgaste e vida útil da ferramenta mais longa
- Formato da pastilha: Canto a 80 graus



www.sandvik.coromant.com/coroturn300

Refrigeração superior e inferior

A refrigeração de alta precisão superior controla a quebra de cavacos para usinagem segura e a refrigeração inferior controla a temperatura para vida útil da ferramenta mais longa e previsível.



Posição estável da pastilha

A pastilha tem autotravamento em seu tip seat graças à solução de fixação por alavanca. A interface iLock entre a pastilha e o suporte previne micromovimentos da pastilha.



Pastilhas

Ferramentas

Torneamento
A17

Unidades de corte Coromant Capto®
A18

Ferramenta convencional QS™
A19



Pastilha CoroTurn® 300 para torneamento

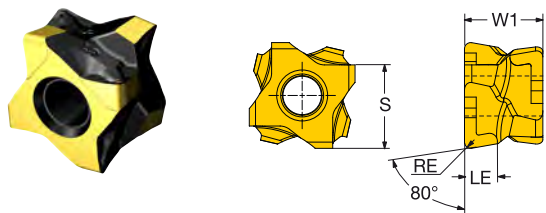

		SSC	LE	S	RE	W1	BS	CÓDIGO ISO	P		K	
									4315	4325	4315	4325
Acabamento	L4	10	4.0	11.00	0.40	10.0		3-80-101104-8-L4	★	☆	★	☆
		4.0	11.00	0.79	10.0			3-80-101108-8-L4	★	☆	★	☆
		4.0	11.00	1.19	10.0			3-80-101112-8-L4	★	☆	★	☆
Média	M5	10	4.0	11.00	0.79	10.0		3-80-101108-8-M5	☆	★	☆	★
		4.0	11.00	1.19	10.0			3-80-101112-8-M5	☆	★	☆	★
	MSW	10	4.0	11.00	0.79	10.0	0.7	3-80-101108-8-M5W	☆	★		
		4.0	11.00	1.19	10.0	0.8		3-80-101112-8-M5W	☆	★		

SSC = Para corresponder ao SSC no suporte.

B

C

D

E

F

G

H



A18



A278



A294



H36



H15



Unidade de corte CoroTurn® 300 para torneamento

Fixação por alavanca

Coromant Capto® - Refrigeração de precisão

KAPR 94.7°

B

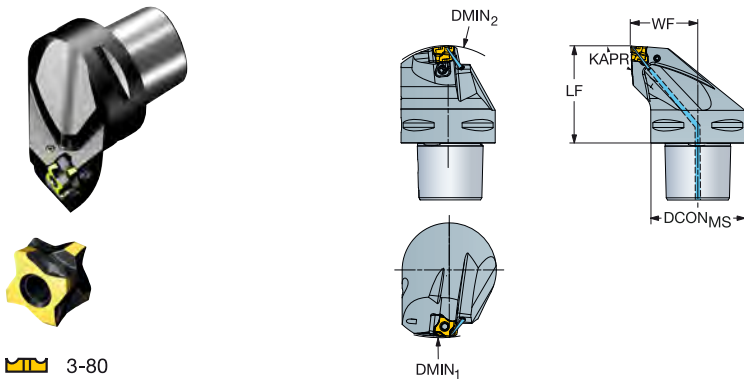

C

3-80

D

SSC	CZC _{MS}	DMIN ₁	DMIN ₂	CNSC	Código para pedido	Dimensões, mm						MIID
						DCON _{MS}	LF	WF	BAR	NM	KG	
10	C4	100.0	150.0	3	C4-3-80-LR/L27055-10C	40.0	55.0	27.0	150	4.5	0.59	3-80-101108
	C5	100.0	170.0	3	C5-3-80-LR/L35060-10C	50.0	60.0	35.0	150	4.5	0.88	3-80-101108
	C6	100.0	200.0	3	C6-3-80-LR/L45065-10C	63.0	65.0	45.0	150	4.5	1.40	3-80-101108

E

KAPR

95.0°

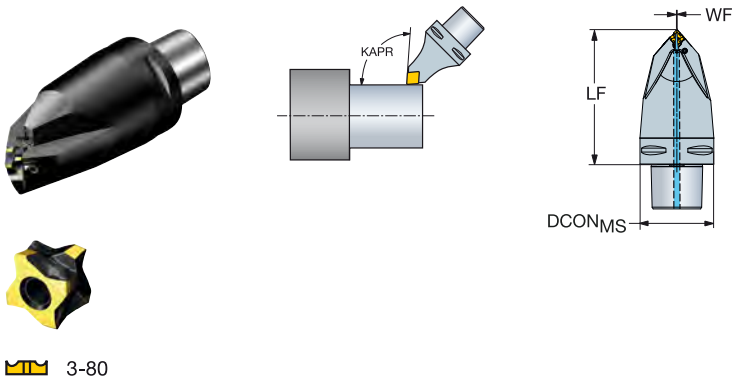

3-80

F

Ferramentas para usinagem multitarefas

SSC	CZC _{MS}	DMIN ₂	CNSC	Código para pedido	Dimensões, mm						MIID
					DCON _{MS}	LF	WF	BAR	NM	KG	
10	C6	250.0	3	C6-3-80-MN00115-10C	63.0	115.0	0.4	150	4.5	2.19	3-80-101108

G

DMIN₁ e DMIN₂ são válidos em combinação com a unidade de fixação R/LC2090.

N = neutra, R = versão direita, L = versão esquerda

SSC = Para corresponder ao SSC na pastilha.

Componentes									
SSC	CZC _{MS}	Grampo	Parafuso do grampo	Calço	Parafuso do calço	Olhal	Parafuso do plugue de vedação	Parafuso para refrigeração	Parafuso do plugue de vedação
10	C4-C5	5412 150-01	5516 010-02	5322 600-01	416.1-832	5691 026-05	3214 013-03	5512 104-01	3214 013-01
10	C6	5412 150-01	5516 010-02	5322 600-01	416.1-832	5691 026-05	3214 013-03	5512 104-01	3214 013-01

H

Para a lista completa de componentes, acesse www.sandvik.coromant.com



Ferramenta convencional CoroTurn® 300 QS para torneamento

Fixação por alavanca

Refrigeração de precisão

KAPR 94.7°



3-80

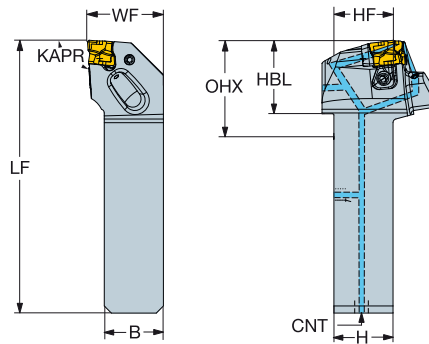

SSC	CZC _{MS}	OHX	CNSC	Código para pedido	Dimensões, mm										MIID
					B	H	HBL	LF	WF	HF	CNT	BAR	NM	KG	
10	20 x 20	54.0	3	QS-3-80LR/L202034-10C	20.0	20.0	34.0	103.0	25.0	20.0	G 1/8-28	150	4.5	0.47	3-80-101108
	25 x 25	56.0	3	QS-3-80LR/L252531-10C	25.0	25.0	31.0	115.0	32.0	25.0	G 1/8-28	150	4.5	0.68	3-80-101108

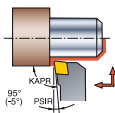

SSC = Para corresponder ao SSC na pastilha.

R = versão direita, L = versão esquerda

Componentes

Grampo	Parafuso do grampo	Calço	Parafuso do calço	Olhal	Parafuso do plugue de vedação	Parafuso para refrigeração	Parafuso do plugue de vedação	Parafuso do plugue de vedação
5412 150-01	5516 010-02	5322 600-01	416.1-832	5691 026-05	3214 013-03	5512 104-01	3214 013-01	3214 012-01

Para a lista completa de componentes, acesse www.sandvik.coromant.com



CoroTurn® TR

Para perfilamento externo e interno estável

POH

B

Aplicação

- Perfilamento
- Usinagem média ao acabamento

Área de aplicação ISO:



Características e benefícios

- A fixação estável da pastilha (iLock) assegura boa repetibilidade e precisão, permitindo uso de dados de corte elevados
- A refrigeração de precisão melhora o controle de cavacos e a vida útil da ferramenta
- Facilidade de conexão da refrigeração e de troca das ferramentas com adaptadores "plug-and-play" ou limitadores QS (hastes QS)



D

www.sandvik.coromant.com/coroturntr

E

Interface de travamento iLock™

Os trilhos tipo T no suporte e os canais correspondentes na pastilha propiciam um travamento seguro e preciso.











F

- Altas estabilidade e tolerância
- Repetibilidade de indexação

Pastilhas

Ferramentas

	
TR-DC.. A21	TR-VB.. A22

Usinagem externa				Usinagem interna	
Unidades de corte Coromant Capto®	Ferramentas convencionais	Ferramenta convencional QS™	Cabeças de corte CoroTurn® SL	Cabeças de corte CoroTurn® SL	Cabeças de corte CoroTurn® SL para mandrilamento reverso
					
A23-A27	A28-A29	A30-A31	A32-A33	A34-A37	A38

G

H



Pastilha CoroTurn® TR para torneamento

Pastilha tipo D (rômbica 55°)

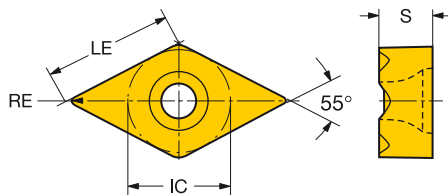
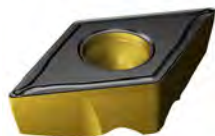

Acabamento	LE	S	RE	CÓDIGO ISO	P		M				K		S					
					1525	4315	4325	1115	1125	2025	2220	4325	H13A	1105	1115	1125	H13A	
F	13	12.6	5.53	0.40	TR-DC1304-F	☆	★	☆	☆	☆	☆	☆	☆	☆	☆	☆	☆	☆
		12.2	5.53	0.79	TR-DC1308-F	☆	★	☆	☆	☆	☆	☆	☆	☆	☆	☆	☆	☆
M	13	12.2	5.53	0.79	TR-DC1308-M	☆	★	☆	☆	☆	☆	☆	☆	☆	☆	☆	☆	☆
		11.8	5.53	1.19	TR-DC1312-M	☆	★	☆	☆	☆	☆	☆	☆	☆	☆	☆	☆	☆

Materiais de corte avançados

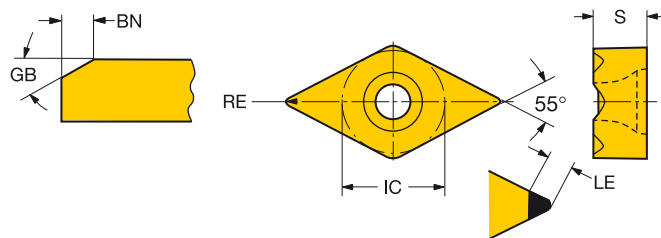
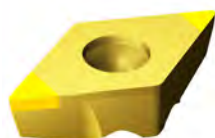

Acabamento	LE	S	RE	GB	BN	CÓDIGO ISO	H						
							7015	7025	705	7115	7125		
	13	3.1	5.53	0.4	20°	0.10	TR-DC1304S01020F	☆	★	☆	☆	☆	☆
		3.1	5.53	0.8	20°	0.10	TR-DC1308S01020F	☆	☆	☆	☆	☆	★



A23



A34



A278



A294



H36



H16



H3

A

Pastilha CoroTurn® TR para torneamento

Pastilha tipo V (rômbica 35°)

B

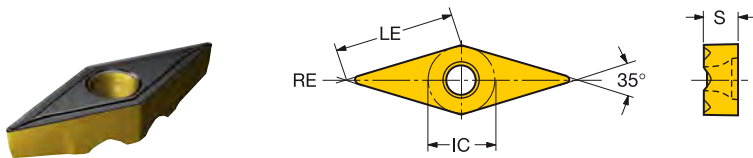

C

Acabamento	F	LE	S	RE	CÓDIGO ISO	P		M				K		S				
						1525	4315	4325	1115	2025	2220	4325	H13A	1105	1115	1125	H13A	
		13	12.8	4.53	0.20	TR-VB1302-F	☆	★	☆	☆	☆	☆	☆	☆	☆	☆	☆	☆
		12.6	4.53	0.40	TR-VB1304-F	☆	★	☆	☆	☆	☆	☆	☆	☆	☆	☆	☆	☆
		12.2	4.53	0.79	TR-VB1308-F	☆	★	☆	☆	☆	☆	☆	☆	☆	☆	☆	☆	☆
		11.8	4.53	1.19	TR-VB1312-F	☆	★	☆	☆	☆	☆	☆	☆	☆	☆	☆	☆	☆

Materiais de corte avançados

D

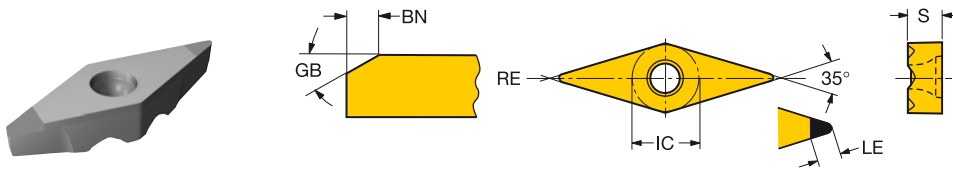

E

Acabamento	F	LE	S	RE	GB	BN	CÓDIGO ISO	H						
								7015	7025	7105	7115	7125		
		13	3.1	4.53	0.4	20°	0.10	TR-VB1304S01020F	☆	☆	☆	☆	☆	★
		2.5	4.53	0.8	20°	0.10	TR-VB1308S01020F	☆	☆	☆	☆	☆	☆	☆

F

G

H



Unidade de corte CoroTurn® TR para torneamento

Fixação por parafuso

Coromant Capto® - Refrigeração interna



TR-DC

KAPR

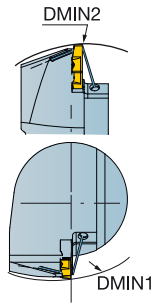

Cx-TR-D13NCN..C
62.5°

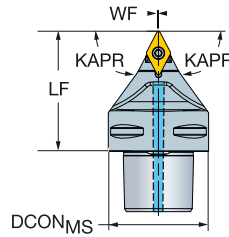

Cx-TR-D13JCR/L..C
93.0°

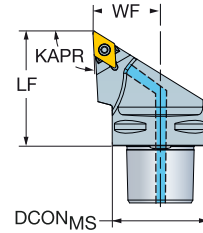

	CZC _{MS}	DMIN ₁	DMIN ₂	RMPX	CNCS	Código para pedido	Dimensões, mm						MID	
							DCON _{MS}	LF	WF	BAR	NM	KG		
	13	C4	251.0	150.0	27°	3	C4-TR-D13JCR/L-27050C	40.0	50.0	27.0	150	3.0	0.37	TR-DC1308
		C5	249.0	175.0	27°	3	C5-TR-D13JCR/L-35060C	50.0	60.0	35.0	150	3.0	0.69	TR-DC1308
		C6	253.0	240.0	27°	3	C6-TR-D13JCR/L-45065C	63.0	65.0	45.0	150	3.0	1.19	TR-DC1308
		C8	253.0	250.0	27°	3	C8-TR-D13JCR/L-55080C	80.0	80.0	55.0	150	3.0	2.54	TR-DC1308
	13	C4		140.0	57°	3	C4-TR-D13NCN-00050C	40.0	50.0	0.5	150	3.0	0.32	TR-DC1308
		C5		165.0	57°	3	C5-TR-D13NCN-00060C	50.0	60.0	0.5	150	3.0	0.62	TR-DC1308
		C6		190.0	57°	3	C6-TR-D13NCN-00065C	63.0	65.0	0.5	150	3.0	1.06	TR-DC1308

N = neutra, R = versão direita, L = versão esquerda

Componentes			
Parafuso da pastilha	Plugue inferior M4	Olhal para refrigeração	Parafuso da pastilha da broca
5513 020-01	3213 010-256	5691 026-03	5680 084-15

Para a lista completa de componentes, acesse www.sandvik.coromant.com



A

TORNEAMENTO GERAL

Ferramentas externas

Unidade de corte CoroTurn® TR para torneamento

Fixação por parafuso

Coromant Capto® - Refrigeração interna

B

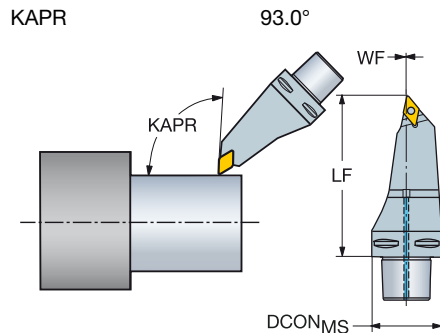

C

 TR-DC

D

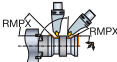

					Dimensões, mm							
13	CZC _{MS} C6	RMPX 30°	CNSC 3	Código para pedido TR-C6-D13MCL-00130	DCON _{MS} 63.0	LF 130.0	WF 0.0	BAR 10	NM 3.0	KG 1.83	MIID TR-DC1308	

L = versão esquerda

Componentes

Parafuso	Olhal
5513 020-01	5691 034-03

Para a lista completa de componentes, acesse www.sandvik.coromant.com

F

G

H



A21



F2



E1



G1



H36



H35



H16



H5

A 24



Unidade de corte CoroTurn® TR para torneamento

Fixação por parafuso

Coromant Capto® - Refrigeração interna



TR-DC

KAPR

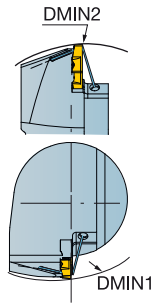

Cx-TR-V13VBN..C
72.5°

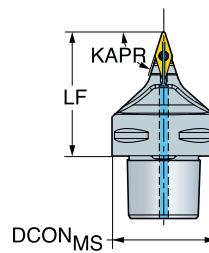

Cx-TR-V13JBR/L..C
93.0°

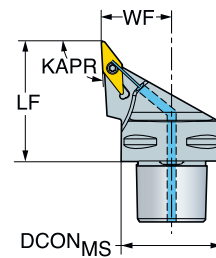

		Dimensões, mm											MID	
		CZC _{MS}	DMIN ₁	DMIN ₂	RMPX	CNSC	Código para pedido	DCON _{MS}	LF	WF	BAR	NM		KG
	13	C4	253.0	140.0	50°	3	C4-TR-V13JBR/L-27050C	40.0	50.0	27.0	150	2.0	0.34	TR-VB1308
		C5	228.0	165.0	50°	3	C5-TR-V13JBR/L-35060C	50.0	60.0	35.0	150	2.0	0.68	TR-VB1308
		C6	232.0	190.0	50°	3	C6-TR-V13JBR/L-45065C	63.0	65.0	45.0	150	2.0	1.14	TR-VB1308
		C8	233.0	250.0	50°	3	C8-TR-V13JBR/L-55080C	80.0	80.0	55.0	150	2.0	2.44	TR-VB1308
	13	C4		140.0	70°	3	C4-TR-V13VBN-00050C	40.0	50.0	0.5	150	2.0	0.29	TR-VB1308
		C5		165.0	70°	3	C5-TR-V13VBN-00060C	50.0	60.0	0.5	150	2.0	0.58	TR-VB1308
		C6		190.0	70°	3	C6-TR-V13VBN-00065C	63.0	65.0	0.5	150	2.0	1.00	TR-VB1308

N = neutra, R = versão direita, L = versão esquerda

Componentes			
Parafuso da pastilha	Plugue inferior M4	Olhal para refrigeração	Parafuso da pastilha da broca
5513 020-64	3213 010-256	5691 026-03	5680 084-21

Para a lista completa de componentes, acesse www.sandvik.coromant.com



Unidade de corte CoroTurn® TR para torneamento

Fixação por parafuso

Coromant Capto® - Refrigeração interna



KAPR

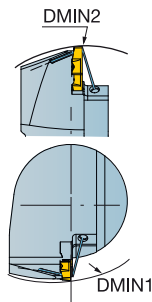

Cx-TR-V13UBR/L..C
93.0°

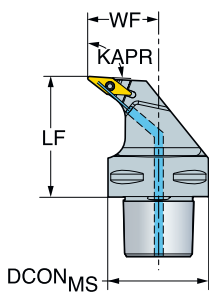

Cx-TR-V13HBR/L..C
107.5°

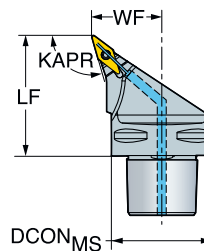

TR-VB

CZC _{MS}	DMIN ₁	DMIN ₂	RMPX	CNCS	Código para pedido	Dimensões, mm						MIID	
						DCON _{MS}	LF	WF	BAR	NM	KG		
13	C4	95.0	140.0	35°	3	C4-TR-V13HBR/L-27050C	40.0	50.0	27.0	150	2.0	0.35	TR-VB1308
	C5	99.0	165.0	35°	3	C5-TR-V13HBR/L-35060C	50.0	60.0	35.0	150	2.0	0.64	TR-VB1308
	C6	150.0	190.0	35°	3	C6-TR-V13HBR/L-45065C	63.0	65.0	45.0	150	2.0	1.15	TR-VB1308
	C8	133.0	250.0	35°	3	C8-TR-V13HBR/L-55080C	80.0	80.0	55.0	150	2.0	2.46	TR-VB1308
13	C4	54.0	140.0	50°	3	C4-TR-V13UBR/L-27050C	40.0	50.0	27.0	150	2.0	0.38	TR-VB1308
	C5	67.0	165.0	50°	3	C5-TR-V13UBR/L-35060C	50.0	60.0	35.0	150	2.0	0.71	TR-VB1308
	C6	118.0	190.0	50°	3	C6-TR-V13UBR/L-45065C	63.0	65.0	45.0	150	2.0	1.24	TR-VB1308
	C8	100.0	250.0	50°	3	C8-TR-V13UBR/L-55080C	80.0	80.0	55.0	150	2.0	2.61	TR-VB1308

R = versão direita, L = versão esquerda

Componentes

Parafuso da pastilha	Plugue inferior M4	Olhal para refrigeração	Parafuso da pastilha da broca
5513 020-64	3213 010-256	5691 026-03	5680 084-21

Para a lista completa de componentes, acesse www.sandvik.coromant.com



Unidade de corte CoroTurn® TR para torneamento

Fixação por parafuso

Coromant Capto® - Refrigeração interna



TR-VB

KAPR

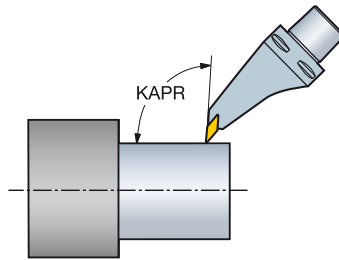

95.0°

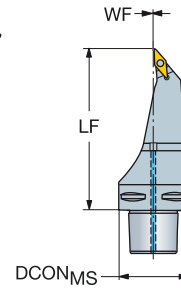

						Dimensões, mm							
		CZC _{MS}	RMPX	CNSC	Código para pedido	DCON _{MS}	LF	WF				MIID	
	13	C5	48°	3	TR-C5-V13MBL-00115	50.0	115.0	0.0	10	2.0	1.00	TR-VB1308	
		C6	48°	3	TR-C6-V13MBL-00130	63.0	130.0	0.0	10	2.0	1.71	TR-VB1308	

L = versão esquerda

Componentes	
Parafuso	Olhal
5513 020-64	5691 034-03

Para a lista completa de componentes, acesse www.sandvik.coromant.com



Ferramenta convencional CoroTurn® TR para torneamento

Fixação por parafuso

B



KAPR



TR-D13NCN
62.5°

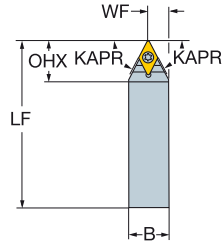

TR-D13JCR/L
93.0°

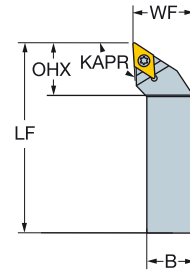

C



TR-DC

D

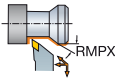

	CZC _{MS}	RMPX	OHX	Código para pedido	Dimensões, mm								MIID
					B	H	LF	WF	HF	NM	KG		
	13	16 x 16	27°	28.5	TR-D13JCR/L 1616K-S	16.0	16.0	125.0	16.0	16.0	3.0	0.27	TR-DC1308
		20 x 20	27°	28.5	TR-D13JCR/L 2020K	20.0	20.0	125.0	25.0	20.0	3.0	0.40	TR-DC1308
		25 x 25	27°	28.5	TR-D13JCR/L 2525M	25.0	25.0	150.0	32.0	25.0	3.0	0.73	TR-DC1308
		32 x 25	27°	28.5	TR-D13JCR/L 3225P	25.0	32.0	170.0	32.0	32.0	3.0	1.05	TR-DC1308
	13	16 x 16	57°	26.0	TR-D13NCN1616K-S	16.0	16.0	125.0	8.3	16.0	3.0	0.30	TR-DC1308
		20 x 20	57°	26.0	TR-D13NCN 2020K	20.0	20.0	125.0	10.5	20.0	3.0	0.40	TR-DC1308
		25 x 25	57°	26.0	TR-D13NCN 2525M	25.0	25.0	150.0	13.0	25.0	3.0	0.70	TR-DC1308
		32 x 25	57°	26.0	TR-D13NCN 3225P	25.0	32.0	170.0	13.0	32.0	3.0	1.03	TR-DC1308

N = neutra, R = versão direita, L = versão esquerda

E

Componentes

Parafuso
5513 020-01

Para a lista completa de componentes, acesse www.sandvik.coromant.com

F

G

H



Ferramenta convencional CoroTurn® TR para torneamento

Fixação por parafuso



TR-VB

KAPR



TR-V13VBN
72.5°

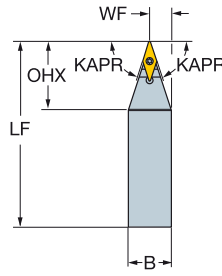

TR-V13JBR/L
93.0°

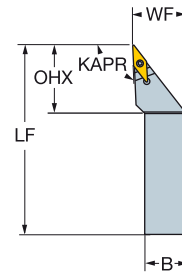

	CZC _{MS}	RMPX	OHX	Código para pedido	Dimensões, mm								MIID
					B	H	LF	WF	HF	NM	KG		
	13	16 x 16	70°	32.0	TR-V13VBN 1616K-S	16.0	16.0	125.0	8.3	16.0	2.0	0.26	TR-VB1308
		20 x 20	70°	31.8	TR-V13VBN 2020K	20.0	20.0	125.0	10.5	20.0	2.0	0.40	TR-VB1308
		25 x 25	70°	39.7	TR-V13VBN 2525M	25.0	25.0	150.0	13.0	25.0	2.0	0.67	TR-VB1308
		32 x 25	70°	39.7	TR-V13VBN 3225P	25.0	32.0	170.0	13.0	32.0	2.0	1.00	TR-VB1308
	13	16 x 16	50°	32.0	TR-V13JBR/L 1616K-S	16.0	16.0	125.0	16.0	16.0	2.0	0.27	TR-VB1308
		20 x 20	50°	32.0	TR-V13JBR/L 2020K	20.0	20.0	125.0	25.0	20.0	2.0	0.40	TR-VB1308
		25 x 25	50°	40.9	TR-V13JBR/L 2525M	25.0	25.0	150.0	32.0	25.0	2.0	0.69	TR-VB1308
		32 x 25	50°	40.9	TR-V13JBR/L 3225P	25.0	32.0	170.0	32.0	32.0	2.0	1.01	TR-VB1308

N = neutra, R = versão direita, L = versão esquerda

Componentes
Parafuso
5513 020-64

Para a lista completa de componentes, acesse www.sandvik.coromant.com



Ferramenta convencional CoroTurn® TR e QS para torneamento

Fixação por parafuso

Refrigeração de precisão



TR-VB

KAPR

QS-TR-V..R/L...HP
93.0°

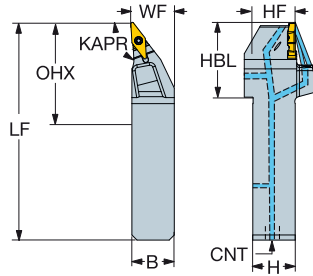

QS-TR-V..N...HP
72.5°

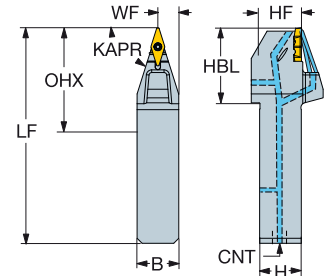

B

C

	CZC _{MS}	RMPX	OHX	CNSC	Código para pedido	Dimensões, mm										MID	
						B	H	HBL	LF	WF	HF	CNT	BAR	NM	KG		
	13	20 x 20	70°	65.0	3	QS-TR-V13VBN 2020HP	20.0	20.0	45.0	114.0	10.5	20.0	G 1/8-28	150	2.0	0.34	TR-VB1308
		25 x 25	70°	70.0	3	QS-TR-V13VBN 2525HP	25.0	25.0	45.0	129.0	13.0	25.0	G 1/8-28	150	2.0	0.57	TR-VB1308
	13	20 x 20	50°	64.0	3	QS-TR-V13JBR/L 2020HP	20.0	20.0	44.0	113.0	20.5	20.0	G 1/8-28	150	2.0	0.34	TR-VB1308
		25 x 25	50°	69.0	3	QS-TR-V13JBR/L 2525HP	25.0	25.0	44.0	128.0	25.5	25.0	G 1/8-28	150	2.0	0.57	TR-VB1308

N = neutra, R = versão direita, L = versão esquerda

D

E

Componentes

Parafuso da pastilha	Olhal	Parafuso para refrigeração	Arruela	Limitador	Limitador
5513 020-64	5691 026-13	5512 104-01	5541 066-01	3214 013-01	3214 012-01

Para a lista completa de componentes, acesse www.sandvik.coromant.com

F

G

H



A

Cabeça CoroTurn® TR para torneamento

Fixação por parafuso

CoroTurn® SL - Refrigeração de precisão

KAPR

93.0°

B

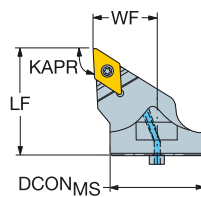

C



TR-DC

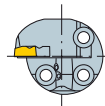

D

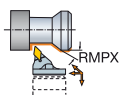

					Dimensões, mm							
	CZC _{MS}	RMPX	CNSC	Código para pedido	DCON _{MS}	LF	WF	BAR	NM	KG	MIID	
13	32	27°	1	TR-SL-D13JCR/L-32HP-X	32.0	40.0	22.0	80	3.0	0.14	TR-DC1308	
	40	27°	1	TR-SL-D13JCR/L-40HP-X	40.0	45.0	27.0	80	3.0	0.23	TR-DC1308	

R = versão direita, L = versão esquerda

Componentes

Parafuso da pastilha	Olhal	Tubo de localização
5513 020-01	5691 026-03	5638 031-01

Para a lista completa de componentes, acesse www.sandvik.coromant.com

F

G

H



A21



F2



H36



H35



H16



H5



H2

Cabeça CoroTurn® TR para torneamento

Fixação por parafuso

CoroTurn® SL - Refrigeração de precisão

KAPR

93.0°

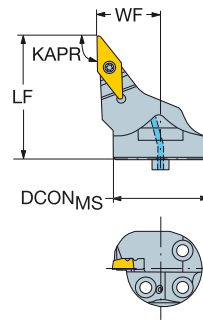

TR-VB

B

C

						Dimensões, mm							
	CZC _{MS}	RMPX	CNSC	Código para pedido	DCON _{MS}	LF	WF	BAR	NM	KG	MIID		
												13	32
	40	44°	1	TR-SL-V13JBR/L-40HP-X	40.0	42.0	27.0	80	2.0	0.18	TR-VB1308		

R = versão direita, L = versão esquerda

D

Componentes		
Parafuso da pastilha	Olhal	Tubo de localização
5513 020-64	5691 026-03	5638 031-01

Para a lista completa de componentes, acesse www.sandvik.coromant.com

E

F

G

H



Cabeça CoroTurn® TR para torneamento

Fixação por parafuso

CoroTurn® SL - Refrigeração de precisão

B



KAPR

TR-SL-D13UCR/L..HP
93.0°

TR-SL-D13XCR/L..HP
62.5°

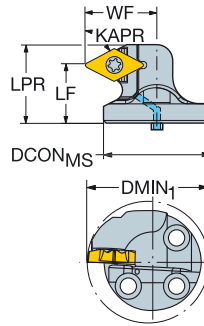
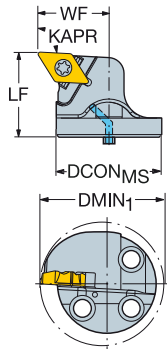

C



TR-DC

D

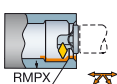
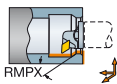

CZC _{MS}	DMIN ₁	RMPX	CNCS	Código para pedido	Dimensões, mm							MIID	
					DCON _{MS}	LPR	LF	WF	BAR	NM	KG		
13	32	40.0	27°	1	TR-SL-D13UCR/L-32HP	32.0	38.0	22.0	80	3.0	0.16	TR-DC1308	
	40	50.0	27°	1	TR-SL-D13UCR/L-40HP	40.0	38.0	27.0	80	3.0	0.23	TR-DC1308	
	40	54.0	27°	1	TR-SL-D13UCR/L-40HP32	40.0	38.0	32.0	80	3.0	0.24	TR-DC1308	
	40	59.0	27°	1	TR-SL-D13UCR/L-40HP37	40.0	38.0	37.0	80	3.0	0.24	TR-DC1308	
	40	63.0	27°	1	TR-SL-D13UCR/L-40HP43	40.0	38.0	43.0	80	3.0	0.27	TR-DC1308	
13	32	45.0	60°	1	TR-SL-D13XCR-32HP	32.0	34.0	27.0	27.0	80	3.0	0.16	TR-DC1308
	40	54.0	60°	1	TR-SL-D13XCR/L-40HP32	40.0	25.7	22.0	32.0	80	3.0	0.20	TR-DC1308
	40	59.0	60°	1	TR-SL-D13XCR/L-40HP37	40.0	25.7	22.0	37.0	80	3.0	0.22	TR-DC1308
	40	63.0	60°	1	TR-SL-D13XCR/L-40HP43	40.0	25.7	22.0	43.0	80	3.0	0.23	TR-DC1308
	40	50.0	60°	1	TR-SL-D13XCR-40HP	40.0	29.5	22.0	29.0	80	3.0	0.19	TR-DC1308

R = versão direita, L = versão esquerda

E

Componentes

Parafuso da pastilha	Olhal	Tubo de localização
5513 020-01	5691 026-03	5638 031-01

Para a lista completa de componentes, acesse www.sandvik.coromant.com

F

G

H



A21



F2



H36



H35



H16



H5



H2

Cabeça CoroTurn® TR para torneamento

Fixação por parafuso

CoroTurn® SL - Refrigeração interna

KAPR

TR-SL-D13UCR/L
93.0°

TR-SL-D13XCR/L
62.5°

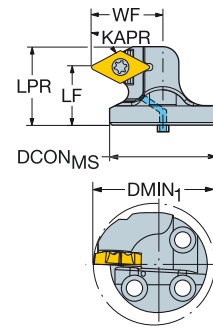
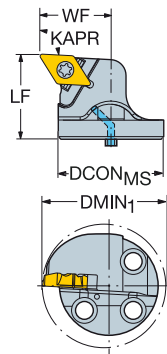

TR-DC

						Dimensões, mm								MID
		CZC _{MS}	DMIN ₁	RMPX	CNSC	Código para pedido	DCON _{MS}	LPR	LF	WF	BAR	NM	KG	
	13	25	35.0	27°	1	TR-SL-D13UCR/L-25	25.0		27.0	20.0	10	3.0	0.08	TR-DC1308
		32	40.0	27°	1	TR-SL-D13UCR/L-32	32.0		32.0	22.0	10	3.0	0.14	TR-DC1308
		40	50.0	27°	1	TR-SL-D13UCR/L-40	40.0		32.0	27.0	10	3.0	0.19	TR-DC1308
	13	25	35.0	60°	1	TR-SL-D13XCR/L-25	25.0	23.3	20.0	20.0	10	3.0	0.07	TR-DC1308
		32	40.0	60°	1	TR-SL-D13XCR/L-32	32.0	29.2	22.0	22.0	10	3.0	0.13	TR-DC1308
		40	50.0	60°	1	TR-SL-D13XCR/L-40	40.0	29.2	22.0	27.0	10	3.0	0.17	TR-DC1308

R = versão direita, L = versão esquerda

Componentes			
	CZC _{MS}	Parafuso da pastilha	Tubo de localização
13	25	5513 020-01	5552 058-02
13	32-40	5513 020-01	5638 031-01

Para a lista completa de componentes, acesse www.sandvik.coromant.com



A

Cabeça CoroTurn® TR para torneamento

Fixação por parafuso

CoroTurn® SL - Refrigeração de precisão

KAPR

95.0°

B

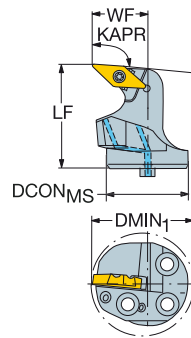

C



TR-VB

D

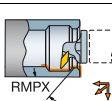

		Dimensões, mm											
		CZC _{MS}	DMIN ₁	RMPX	CNSC	Código para pedido	DCON _{MS}	LF	WF	BAR	NM	KG	MIID
	13	32	40.0	45°	1	TR-SL-V13LBR/L-32HP	32.0	40.0	22.0	80	2.0	0.17	TR-VB1308
		40	50.0	45°	1	TR-SL-V13LBR/L-40HP	40.0	38.0	27.0	80	2.0	0.22	TR-VB1308

R = versão direita, L = versão esquerda

E

Componentes		
Parafuso da pastilha	Olhal	Tubo de localização
5513 020-64	5691 026-03	5638 031-01

Para a lista completa de componentes, acesse www.sandvik.coromant.com

F

G

H



Cabeça CoroTurn® TR para torneamento

Fixação por parafuso

CoroTurn® SL - Refrigeração interna

KAPR

TR-SL-V13LBR/L
95.0°

TR-SL-V13PBR/L
117.5°

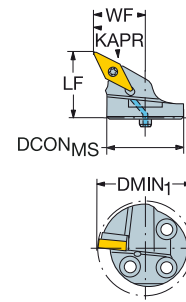
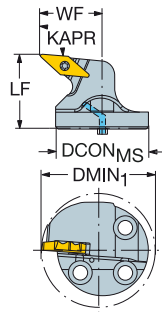

TR-VB

	CZC _{MS}	DMIN ₁	RMPX	CNSC	Código para pedido	Dimensões, mm						MIID	
						DCON _{MS}	LF	WF	BAR	NM	KG		
	13	25	35.0	45°	1	TR-SL-V13LBR/L-25	25.0	27.0	20.0	10	2.0	0.08	TR-VB1308
	32	40.0	45°	1	TR-SL-V13LBR/L-32	32.0	32.0	22.0	10	2.0	0.13	TR-VB1308	
	40	50.0	45°	1	TR-SL-V13LBR/L-40	40.0	32.0	27.0	10	2.0	0.18	TR-VB1308	
	13	25	33.0	25°	1	TR-SL-V13PBR/L-25	25.0	28.0	17.0	10	2.0	0.07	TR-VB1308
	32	40.0	25°	1	TR-SL-V13PBR/L-32	32.0	32.0	22.0	10	2.0	0.12	TR-VB1308	
	40	50.0	25°	1	TR-SL-V13PBR/L-40	40.0	32.0	27.0	10	2.0	0.15	TR-VB1308	

R = versão direita, L = versão esquerda

Componentes			
CZC _{MS}	Parafuso da pastilha	Tubo de localização	
13	25	5513 020-64	5552 058-02
13	32-40	5513 020-64	5638 031-01

Para a lista completa de componentes, acesse www.sandvik.coromant.com



Cabeça CoroTurn® TR para mandrilamento reverso

Fixação por parafuso

CoroTurn® SL - Refrigeração interna

KAPR

93.0°

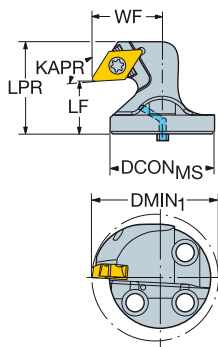
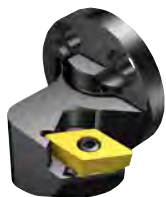

TR-DC

B

C

D

CZC _{MS}	DMIN ₁	RMPX	CNSC	Código para pedido	Dimensões, mm				BAR	NM	KG	MIID	
					DCON _{MS}	LPR	LF	WF					
13	25	36.0	27°	1	TR-SL-D13UCR/L-25X	25.0	32.1	17.0	21.0	10	3.0	0.09	TR-DC1308
	32	40.0	27°	1	TR-SL-D13UCR/L-32X	32.0	35.1	20.0	22.0	10	3.0	0.14	TR-DC1308
	40	50.0	27°	1	TR-SL-D13UCR/L-40X	40.0	35.1	20.0	27.0	10	3.0	0.20	TR-DC1308

R = versão direita, L = versão esquerda

E

Componentes			
CZC _{MS}	Parafuso da pastilha	Tubo de localização	
13	25	5513 020-01	5552 058-02
13	32-40	5513 020-01	5638 031-01

Para a lista completa de componentes, acesse www.sandvik.coromant.com

F

G

H



CoroTurn® 107

Torneamento interno e externo de peças delgadas

Aplicação

- Torneamento longitudinal
- Perfilamento
- Mandrilamento reverso
- Usinagem média ao acabamento

Área de aplicação ISO:



Características e benefícios

- Baixas forças de corte
- A fixação por parafuso assegura estabilidade e fluxo livre de cavacos
- Geometrias e classes de pastilha para todos os materiais
- Geometrias Wiper disponíveis para excelente acabamento superficial e altos avanços
- Suportes e geometrias de pastilha com desenho convencional e CoroTurn HP



www.sandvik.coromant.com/coroturn107

Pastilha positiva com formato básico

- Ângulo de folga 5°, 7°
- Todos os tipos de formatos e tamanhos de pastilhas
- Geometrias e classes para todas as áreas de aplicação
- Classes de pastilhas também em materiais de corte avançados PCD, CBN e cerâmicas

Ferramentas

- Unidades de corte Coromant Capto®
- Ferramentas convencionais
- Ferramentas convencionais QS
- Barras de mandrilar
- Cabeças CoroTurn® SL

Ferramentas com EasyFix™ e Silent Tools™ disponíveis.

Desenvolvido para refrigeração de precisão

Os suportes estão disponíveis com olhais de precisão para excelente controle de cavacos.

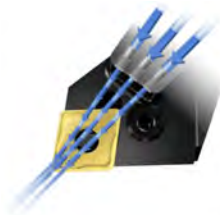

Fixação por parafuso

Acrescenta estabilidade e fluxo livre de cavacos



A40



A58



A88



H35

A

Pastilha CoroTurn® 107 para torneamento

Acabamento

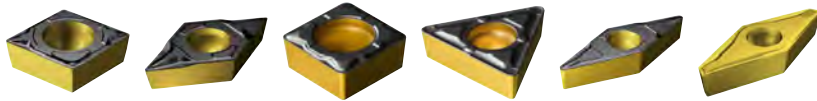

Página	CC.. A41	DC.. A45	SC.. A49	TC.. A51	VB.. A55	VC.. A55
--------	-------------	-------------	-------------	-------------	-------------	-------------

Média



Página	CC.. A41	DC.. A45	RC.. A48	SC.. A49	TC.. A51	VB.. A55	VC.. A55
--------	-------------	-------------	-------------	-------------	-------------	-------------	-------------

Desbaste

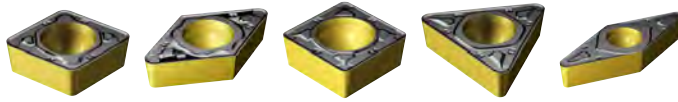

Página	CC.. A41	DC.. A45	SC.. A49	TC.. A51	VB.. A55
--------	-------------	-------------	-------------	-------------	-------------

Materiais de corte avançados

Nitreto cúbico de boro (CBN)

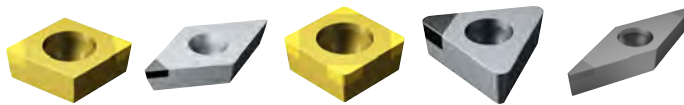

Página	CC.. A41	DC.. A47	SC.. A50	TC.. A54	VB.. A57
--------	-------------	-------------	-------------	-------------	-------------

Diamante policristalino (PCD)

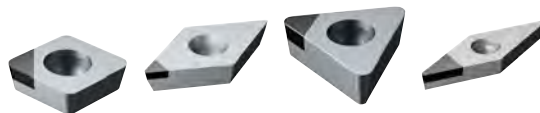

Página	CC.. A44	DC.. A47	TC.. A54	VC.. A57
--------	-------------	-------------	-------------	-------------

B

C

D

E

F

G

H

Pastilha CoroTurn® 107 para torneamento

Pastilha tipo C (rômbica 80°)

Materiais de corte avançados - geometria Xcel

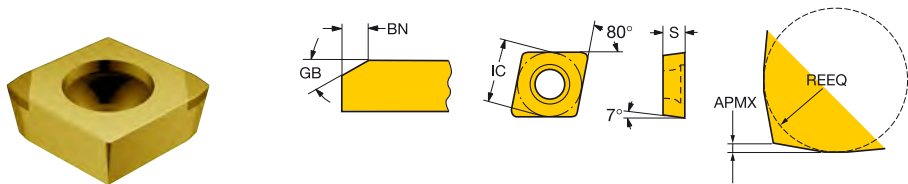

Acabamento	LE	S	REEQ	APMX	GB	BN	CÓDIGO ISO	H				
								7015	7025	7105	7115	7125
09	2.3	3.97	1.9	0.2	15°	0.15	CCGX09T3L020-15FXA	☆	☆	☆	☆	★



A58



A88



A278



A294



H36



H6



H3



Pastilha CoroTurn® 107 para torneamento

Pastilha tipo D (rômbica 55°)

Materiais de corte avançados

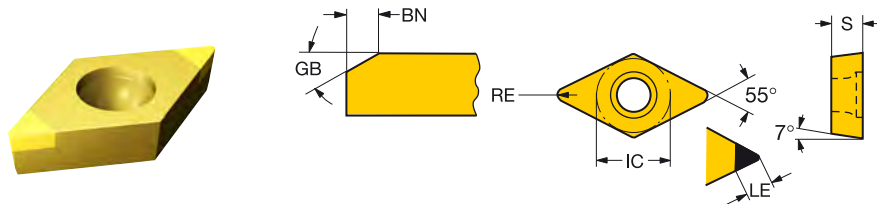

	LE	S	RE	BS	GB	BN	CÓDIGO ISO	K		N		H									
								7525	CD05	CD10	7015	7025	7105	7115	7125	7135	7525				
Acabamento	07	2.5	2.38	0.2	20°	0.10	DCGW070202S01020F														
		2.5	2.38	0.2	20°	0.10	DCGW070202T01020F														
		1.5	2.38	0.2	30°	0.10	DCGW070202T01030F					☆	★								
		2.9	2.38	0.4	20°	0.10	DCGW070204S01020F					☆	☆	☆	☆	★					
		2.9	2.38	0.4	30°	0.10	DCGW070204S01030F					☆	☆							★	
		2.9	2.38	0.4	30°	0.15	DCGW070204S01530F													★	
		2.8	2.38	0.4	20°	0.10	DCGW070204T01020F	★												★	
		2.5	2.38	0.8	20°	0.10	DCGW070208S01020F									★					
		2.1	2.38	0.8	30°	0.10	DCGW070208S01030F					☆	★								
		11	2.8	3.97	0.2	20°	0.10	DCGW11T302T01020F	★												★
			1.8	3.97	0.4	20°	0.10	DCGW11T304S01020F					☆	☆	☆	☆	★				
			2.9	3.97	0.4	30°	0.15	DCGW11T304S01530F					☆	☆					★	☆	
			2.9	3.97	0.4	30°	0.20	DCGW11T304S02030F								★					
			2.9	3.97	0.4	20°	0.10	DCGW11T304T01020F	★				☆								★
			2.5	3.97	0.8	20°	0.10	DCGW11T308S01020F					☆	☆	☆	☆	★				
			3.1	3.97	0.8	30°	0.15	DCGW11T308S01530F					☆	☆					★	☆	
			2.5	3.97	0.8	30°	0.20	DCGW11T308S02030F							☆	★					
			3.1	3.97	0.8	20°	0.10	DCGW11T308T01020F	★				☆								★
			2.1	3.97	1.2	20°	0.10	DCGW11T312S01020F					☆	★	☆	★					
			2.4	3.97	1.2	30°	0.15	DCGW11T312S01530F					★								
		4.1	3.97	0.4			DCMW11T304FP		☆	★											
		3.8	3.97	0.8			DCMW11T308FP		☆	★											
		1.8	3.97	0.4	0.5	20°	0.10	DCGW11T304S01020FWH				☆	★								
		2.9	3.97	0.4	0.5	20°	0.15	DCGW11T304S01520FWH				☆	★		☆	★					
		2.1	3.97	0.8	0.6	20°	0.10	DCGW11T308S01020FWH				☆	☆							★	
		2.5	3.97	0.8	0.6	20°	0.15	DCGW11T308S01520FWH				☆	☆		☆	★					



A58



A88



A278



A294



H36



H6



H3

A

TORNEAMENTO GERAL

Pastilhas

Pastilha CoroTurn® 107 para torneamento

Pastilha tipo S (quadrada)

Materiais de corte avançados

B

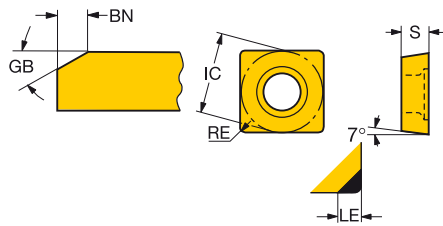
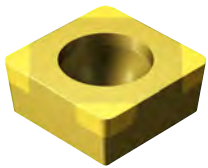

C

Acabamento	LE	S	RE	GB	BN	CÓDIGO ISO	H		
							7015	7025	7525
09	1.8	3.97	0.4	30°	0.10	SCGW09T304S01030F	☆	★	
	2.8	3.97	0.4	20°	0.10	SCGW09T304T01020F			★
	2.1	3.97	0.8	30°	0.10	SCGW09T308S01030F	☆	★	
	3.1	3.97	0.8	30°	0.15	SCGW09T308S01530F			★
	3.1	3.97	0.8	20°	0.10	SCGW09T308T01020F			★

D

E

F

G

H



A58



A88

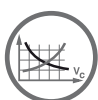

A278



A294



H36



H6



H3

A

Pastilha CoroTurn® 107 para torneamento

Pastilha tipo T (triangular)

Materiais de corte avançados

B

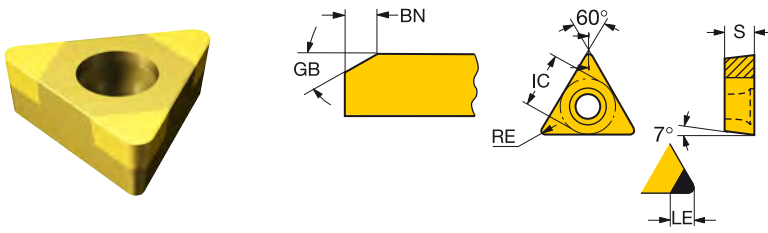

C

C	LE	S	RE	GB	BN	CÓDIGO ISO	H											
							7525	CD05	CD10	7015	7025	7105	7115	7125	7135	7525		
D	06	2.0	1.59	0.2	20°	0.10	TCGW06T102S01020E											
		1.5	1.98	0.2	20°	0.10	TCGW06T102T01020E					*						
		1.8	1.98	0.4	20°	0.10	TCGW06T104S01020E				*	*	*				*	
	09	1.8	2.38	0.2	20°	0.10	TCGW090202S01020F				*	*	*					
		2.5	2.38	0.2	20°	0.10	TCGW090202T01020F				*	*	*	*				
		1.8	2.38	0.4	20°	0.10	TCGW090204S01020F				*	*	*	*				
		1.8	2.38	0.4	30°	0.10	TCGW090204S01030F				*	*	*	*				
		2.8	2.38	0.4	30°	0.15	TCGW090204S01530F				*	*	*	*	*		*	
		2.7	2.38	0.4			TCMW090204FP	*	*									
	E	11	2.8	2.38	0.2	20°	0.10	TCGW110202T01020F										*
			1.8	2.38	0.4	20°	0.10	TCGW110204S01020F				*	*					*
			2.8	2.38	0.4	20°	0.10	TCGW110204T01020F	*									*
Acabamento		2.9	2.38	0.8	20°	0.10	TCGW110208S01020F				*	*						*
		2.0	2.38	0.8	30°	0.15	TCGW110208S01530F				*	*						*
		1.8	3.18	0.4	20°	0.10	TCGW110304S01020F				*	*	*	*	*			*
		2.8	3.18	0.4	30°	0.15	TCGW110304S01530F				*	*	*	*	*	*		*
		2.8	3.18	0.4	20°	0.10	TCGW110304T01020F				*	*	*	*	*			*
		2.5	3.18	0.8	20°	0.10	TCGW110308S01020F				*	*	*	*	*	*		*
		2.9	3.18	0.8	30°	0.15	TCGW110308S01530F				*	*	*	*	*	*	*	*
		2.9	3.18	0.8	20°	0.10	TCGW110308T01020F				*	*	*	*	*	*		*
		2.7	2.38	0.4			TCMW110204FP	*	*									
2.4	2.38	0.8			TCMW110208FP	*	*											
2.7	3.18	0.4			TCMW110304FP	*	*											
2.4	3.18	0.8			TCMW110308FP	*	*											
F	16	7.4	3.97	0.4			TCMW16T304FLP				*	*						
		4.2	3.97	0.4			TCMW16T304FP	*	*		*	*						
		7.4	3.97	0.4			TCMW16T304FRP	*	*		*	*						
		3.9	3.97	0.8			TCMW16T308FP	*	*		*	*						

F

G

H



Pastilha CoroTurn® 107 para torneamento

Pastilha tipo V (rômbica 35°)

Materiais de corte avançados

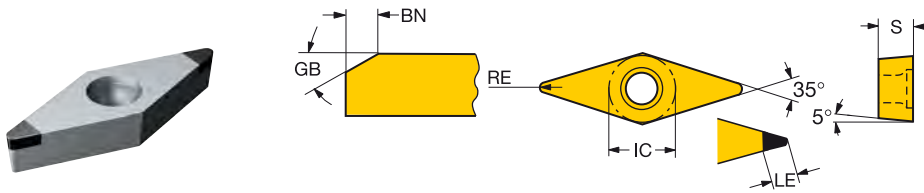

	LE	S	RE	GB	BN	CÓDIGO ISO	Materiais de Corte									
							K	N	H						7525	
							7525	CD05	CD10	7015	7025	7105	7115	7125	7135	7525
Acabamento	11	2.5	3.18	0.2	20°	0.10	VBGW110302S01020F									
		2.3	3.18	0.2	20°	0.10	VBGW110302T01020F				*					
		2.5	3.18	0.4	20°	0.10	VBGW110304S01020F			*	*	*	*	*		*
		2.5	3.18	0.4	30°	0.15	VBGW110304S01530F			*						*
		4.4	2.38	0.4			VCMW110204FP		*	*						
		4.4	3.18	0.4			VCMW110304FP			*						
		16	3.0	4.76	0.4	20°	0.10	VBGW160404S01020F			*	*	*	*	*	
			3.0	4.76	0.4	30°	0.10	VBGW160404S01030F			*	*	*	*	*	
			2.5	4.76	0.4	30°	0.15	VBGW160404S01530F			*					*
			4.0	4.76	0.4	20°	0.10	VBGW160404T01020F	*			*	*	*	*	*
			3.0	4.76	0.8	20°	0.10	VBGW160408S01020F			*	*	*	*	*	
			2.5	4.76	0.8	30°	0.15	VBGW160408S01530F			*	*	*	*	*	*
			4.0	4.76	0.8	20°	0.10	VBGW160408T01020F	*			*	*	*	*	*
			4.4	4.76	0.4			VCMW160404FP		*	*					
		3.5	4.76	0.8			VCMW160408FP		*	*						
		2.7	4.76	1.2			VCMW160412FP		*	*						

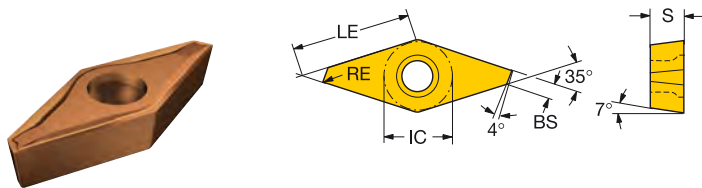

	LE	S	RE	BS	CÓDIGO ISO	Materiais de Corte									
						P	M		K	N	S				
						1125	5015	1105	1115	1125	5015	1125	1105	1115	1125
Acabamento	11	11.1	3.18	0.0	1.4	VCEX 11 03 00L-F	*	*	*	*	*	*	*	*	*
		11.1	3.18	0.0	1.4	VCEX 11 03 00R-F	*	*	*	*	*	*	*	*	*
		11.0	3.18	0.1	1.2	VCEX 11 03 01L-F	*	*	*	*	*	*	*	*	*
		11.0	3.18	0.1	1.2	VCEX 11 03 01R-F	*	*	*	*	*	*	*	*	*



A58



A88

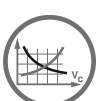

A278



A294



H36



H35



H6



H3

Ferramentas CoroTurn® 107 para usinagem externa

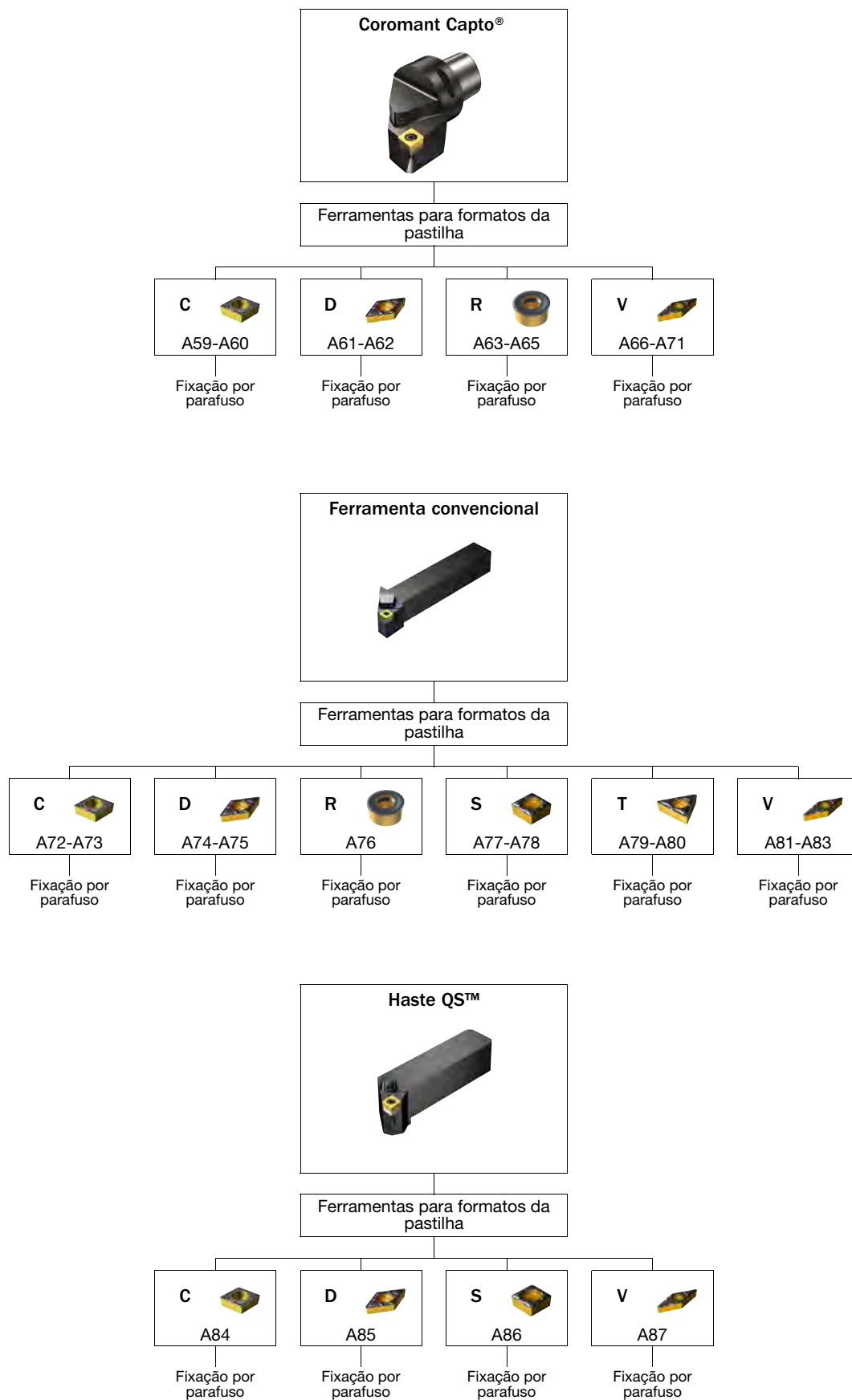

Unidade de corte CoroTurn® 107 para torneamento

Fixação por parafuso

Coromant Capto® - Refrigeração de precisão

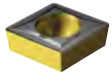

- CCMT, CCGT
- CCGX, CCET
- CCMW

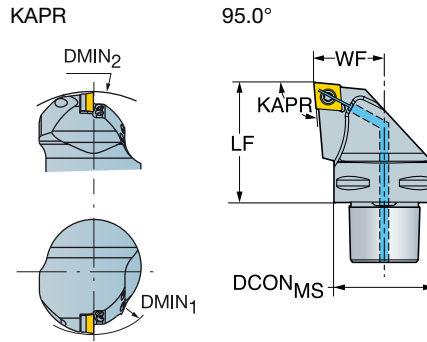

MIID	CZC _{MS}	DMIN ₁	DMIN ₂	CNSC	Código para pedido	Dimensões, mm						MIID
						DCON _{MS}	LF	WF	BAR	NM	KG	
09	C3	265.0	700.0	3	C3-SCLCR/L-22040-09C	32.0	40.0	22.0	150	3.0	0.20	CCMT 09 T3 08
	C4	272.0	600.0	3	C4-SCLCR/L-27050-09C	40.0	50.0	27.0	150	3.0	0.43	CCMT 09 T3 08
12	C4	210.0	600.0	3	C4-SCLCR/L-27050-12C	40.0	50.0	27.0	150	3.0	0.44	CCMT 12 04 08
	C5	204.0	550.0	3	C5-SCLCR/L-35060-12C	50.0	60.0	35.0	150	3.0	0.77	CCMT 12 04 08
	C6	208.0	800.0	3	C6-SCLCR/L-45065-12C	63.0	65.0	45.0	150	3.0	1.34	CCMT 12 04 08

N = neutra, R = versão direita, L = versão esquerda

Componentes						
MIID	Parafuso da pastilha	Parafuso do calço	Calço	Plugue inferior M4	Olhal para refrigeração	Parafuso da pastilha da broca
CCMT 09	5513 020-01	5512 090-01	5322 232-01	3213 010-256	5691 026-03	5680 084-15
CCMT 12	5513 020-18	5512 090-03	5322 232-02	3213 010-256	5691 026-03	5680 084-15

Para a lista completa de componentes, acesse www.sandvik.coromant.com



Unidade de corte CoroTurn® 107 para torneamento

Fixação por parafuso

Coromant Capto® - Refrigeração interna

B



KAPR

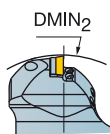

Cx-SCLCR/L
95.0°

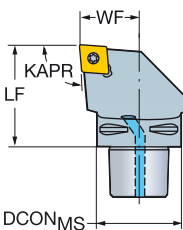

Cx-SCMCN (M-T)
95.0°

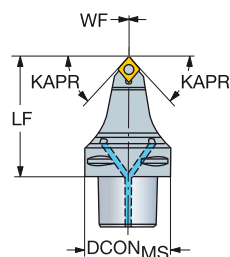

C

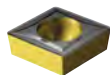

- CCMT, CCGT
CCGX, CCET
- CCMW

D

Código para pedido	CZC _{MS}	DMIN ₁	DMIN ₂	CNSC	Dimensões, mm							MIID
					DCON _{MS}	LF	WF	BAR	NM	KG		
09	C3	130.0	116.0	3	C3-SCLCR/L-22040-09	32.0	40.0	22.0	10	3.0	0.24	CCMT 09 T3 08
	C4	130.0	140.0	3	C4-SCLCR/L-27050-09	40.0	50.0	27.0	10	3.0	0.46	CCMT 09 T3 08
	C5	130.0	165.0	3	C5-SCLCR/L-35060-09	50.0	60.0	35.0	10	3.0	0.87	CCMT 09 T3 08
	C6	130.0	190.0	3	C6-SCLCR/L-45065-09	63.0	65.0	45.0	10	3.0	1.50	CCMT 09 T3 08
12	C3	125.0	116.0	3	C3-SCLCR/L-22040-12	32.0	40.0	22.0	10	3.0	0.24	CCMT 12 04 08
	C4	125.0	140.0	3	C4-SCLCR/L-27050-12	40.0	50.0	27.0	10	3.0	0.45	CCMT 12 04 08
	C5	125.0	165.0	3	C5-SCLCR/L-35060-12	50.0	60.0	35.0	10	3.0	0.85	CCMT 12 04 08
	C6	125.0	190.0	3	C6-SCLCR/L-45065-12	63.0	65.0	45.0	10	3.0	1.49	CCMT 12 04 08

E

Código para pedido	CZC _{MS}	CNSC	Dimensões, mm							MIID
			DCON _{MS}	LF	WF	BAR	NM	KG		
12	C6	3	C6-SCMCN-00090-12	63.0	90.0	0.0	10	3.0	1.35	CCMT 12 04 08

N = neutra, R = versão direita, L = versão esquerda

F

Código para pedido	Componentes			
	Parafuso	Calço	Parafuso do calço	Olhal
C3-SCLCR/L-22040-09	5513 020-01	5322 232-01	5512 090-01	5691 034-01
C4-SCLCR/L-27050-09	5513 020-01	5322 232-01	5512 090-01	5691 034-01
C5-SCLCR/L-35060-09	5513 020-01	5322 232-01	5512 090-01	5691 034-02
C6-SCLCR/L-45065-09	5513 020-01	5322 232-01	5512 090-01	5691 034-02
C3-SCLCR/L-22040-12	5513 020-18	5322 232-02	5512 090-03	5691 034-01
C4-SCLCR/L-27050-12	5513 020-18	5322 232-02	5512 090-03	5691 034-01
C5-SCLCR/L-35060-12	5513 020-18	5322 232-02	5512 090-03	5691 034-02
C6-SCLCR/L-45065-12	5513 020-18	5322 232-02	5512 090-03	5691 034-02
C6-SCMCN-00090-12	5513 020-18	5322 232-02	5512 090-03	5691 045-01

Para a lista completa de componentes, acesse www.sandvik.coromant.com

H



Unidade de corte CoroTurn® 107 para torneamento

Fixação por parafuso

Coromant Capto® - Refrigeração de precisão

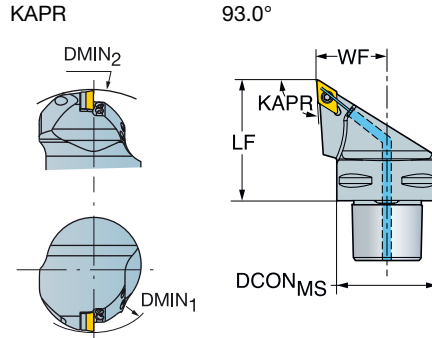

- CCMT, CCGT
CCGX, CCET
- CCMW

	CZC _{MS}	DMIN ₁	DMIN ₂	RMPX	CNCS	Código para pedido	Dimensões, mm						MIID	
							DCON _{MS}	LF	WF	BAR	NM	KG		
	11	C3	244.0	135.0	27°	3	C3-SDJCR/L-22040-11C	32.0	40.0	22.0	150	3.0	0.19	DCMT 11 T3 08
		C4	246.0	140.0	27°	3	C4-SDJCR/L-27050-11C	40.0	50.0	27.0	150	3.0	0.38	DCMT 11 T3 08
		C5	250.0	165.0	27°	3	C5-SDJCR/L-35060-11C	50.0	60.0	35.0	150	3.0	0.70	DCMT 11 T3 08
		C6	250.0	190.0	27°	3	C6-SDJCR/L-45065-11C	63.0	65.0	45.0	150	3.0	1.19	DCMT 11 T3 08

R = versão direita, L = versão esquerda

Componentes

Parafuso da pastilha	Parafuso do calço	Calço	Plugue inferior M4	Olhal para refrigeração	Parafuso da pastilha da broca
5513 020-01	5512 090-01	5322 263-01	3213 010-256	5691 026-03	5680 084-15

Para a lista completa de componentes, acesse www.sandvik.coromant.com



Unidade de corte CoroTurn® 107 para torneamento

Fixação por parafuso

Coromant Capto® - Refrigeração interna

B



KAPR

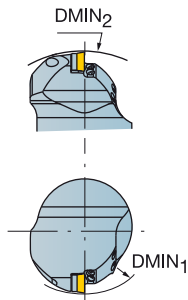

Cx-SDJCR/L
93.0°

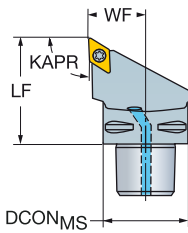

Cx-SDNCN
62.5°

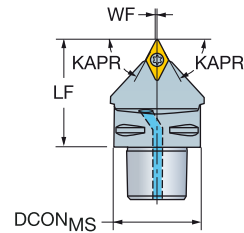

C

- DCMT, DCMX
DCGT, DCGX, DCET
- DCMW

D

	CZC _{MS}	DMIN ₁	DMIN ₂	RMPX	CNCS	Código para pedido	Dimensões, mm						MID	
							DCON _{MS}	LF	WF	BAR	NM	KG		
	07	C3	70.0	116.0	27°	3	C3-SDJCR-22040-07	32.0	40.0	22.0	10	0.9	0.21	DCMT 07 02 04
		C4	70.0	140.0	27°	3	C4-SDJCR-27050-07	40.0	50.0	27.0	10	0.9	0.26	DCMT 07 02 04
	11	C3	116.0	57°	3	C3-SDNCN-00040-11	32.0	40.0	0.5	10	3.0	0.20	DCMT 11 T3 08	
		C4	140.0	57°	3	C4-SDNCN-00050-11	40.0	50.0	0.5	10	3.0	0.38	DCMT 11 T3 08	
		C5	165.0	57°	3	C5-SDNCN-00060-11	50.0	60.0	0.5	10	3.0	0.66	DCMT 11 T3 08	

N = neutra, R = versão direita, L = versão esquerda

E

Componentes					
	CZC _{MS}	Parafuso	Calço	Parafuso do calço	Olhal
	07	C3-C4	5513 020-03		5691 034-01
	11	C3-C4	5513 020-01	5322 263-01	5512 090-01
	11	C5-C6	5513 020-01	5322 263-01	5512 090-01

F

Para a lista completa de componentes, acesse www.sandvik.coromant.com

G

H



Unidade de corte CoroTurn® 107 para torneamento

Fixação por parafuso

Coromant Capto® - Refrigeração de precisão



RCMT
RCGX-AL

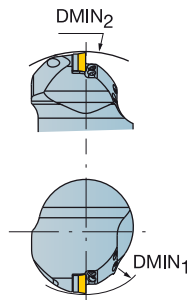

Cx-SRSCR/L..HP

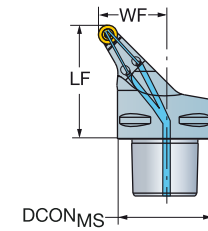

Cx-SRDCN..HPA

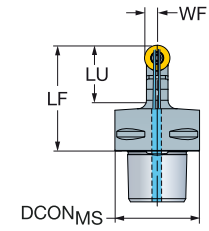

	CZC _{MS}	DMIN ₁	DMIN ₂	LU	RMPX	CNSC	Código para pedido	Dimensões, mm			MIID				
								DCON _{MS}	LF	WF		BAR	NM	KG	
	10	C5	130.0	270.0	45°	3	C5-SRSCR/L-35060-10HP	50	60.0	35.0	150	3.0	0.70	RCMT 10 T3 M0	
		C6	140.0	300.0	45°	3	C6-SRSCR/L-45065-10HP	63	65.0	45.0	150	3.0	1.22	RCMT 10 T3 M0	
	12	C5	130.0	270.0	45°	3	C5-SRSCR/L-35060-12HP	50	60.0	35.0	150	3.0	0.70	RCMT 12 04 M0	
		C5	150.0	165.0	45°	3	C5-SRSCR/L-35060-12HPA	50	60.0	35.0	150	3.0	0.70	RCMT 12 04 M0	
		C6	120.0	195.0	27°	3	C6-SRSCR/L-45065-12HP	63	65.0	45.0	150	3.0	1.37	RCMT 12 04 M0	
		C6	150.0	190.0	27°	3	C6-SRSCR/L-45065-12HPA	63	65.0	45.0	150	3.0	1.25	RCMT 12 04 M0	
	16	C5	175.0	165.0	45°	3	C5-SRSCR/L-35060-16HPA	50	60.0	35.0	150	6.4	0.70	RCMT 16 06 M0	
		C6	175.0	190.0	27°	3	C6-SRSCR/L-45065-16HPA	63	65.0	45.0	150	6.4	1.25	RCMT 16 06 M0	
	10	C5		165.0	25.0	90°	3	C5-SRDCN00060-10AHPA	50	60.0	5.0	150	3.0	0.70	RCMT 10 T3 M0
	12	C4		140.0	28.0	90°	3	C4-SRDCN00050-12AHPA	40	50.0	6.0	150	3.0	0.34	RCMT 12 04 M0
		C5		165.0	28.0	90°	3	C5-SRDCN00060-12AHPA	50	60.0	6.0	150	3.0	0.63	RCMT 12 04 M0
		C6		190.0	28.0	90°	3	C6-SRDCN00065-12AHPA	63	65.0	6.0	150	3.0	1.05	RCMT 12 04 M0
	C6		190.0	28.0	90°	3	C6-SRDCN-00065-12HP	63	65.0	6.0	150	3.0	1.13	RCMT 12 04 M0	
	16	C6		190.0	35.0	90°	3	C6-SRDCN00065-16AHPA	63	65.0	8.0	150	6.4	1.04	RCMT 16 06 M0

N = neutra, R = versão direita, L = versão esquerda

Código para pedido	Componentes			
	Parafuso da pastilha	Calço	Parafuso do calço	Olhal
C5-SRDCN00060-10AHPA	5513 020-10	5322 110-01	5512 090-01	5691 026-13
C5-SRSCR/L-35060-10HP	5513 020-10	5322 110-01	5512 090-01	5691 026-03
C6-SRSCR/L-45065-10HP	5513 020-10	5322 110-01	5512 090-01	5691 026-03
C4-SRDCN00050-12AHPA	5513 020-01	5322 110-02	5512 090-01	5691 026-13
C5-SRDCN00060-12AHPA	5513 020-01	5322 110-02	5512 090-01	5691 026-13
C5-SRSCR/L-35060-12HP	5513 020-01	5322 110-02	5512 090-01	5691 026-03
C5-SRSCR/L-35060-12HPA	5513 020-01	5322 110-02	5512 090-01	5691 026-03
C6-SRDCN00065-12AHPA	5513 020-01	5322 110-02	5512 090-01	5691 026-13
C6-SRDCN-00065-12HP	5513 020-01	5322 110-02	5512 090-01	5691 026-03
C6-SRSCR/L-45065-12HP	5513 020-01	5322 110-02	5512 090-01	5691 026-03
C6-SRSCR/L-45065-12HPA	5513 020-01	5322 110-02	5512 090-01	5691 026-03
C5-SRSCR/L-35060-16HPA	5513 020-26	5322 110-03	5512 090-06	5691 026-03
C6-SRDCN00065-16AHPA	5513 020-26	5322 110-03	5512 090-06	5691 026-03
C6-SRSCR/L-45065-16HPA	5513 020-26	5322 110-03	5512 090-06	5691 026-03

Para a lista completa de componentes, acesse www.sandvik.coromant.com



Unidade de corte CoroTurn® 107 para torneamento

Fixação por parafuso

Coromant Capto® - Refrigeração interna

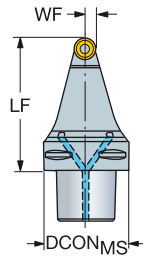

C RCMT
RCGX-AL

					Dimensões, mm							MIID
		CZC _{MS}	RMPX	CNSC	Código para pedido	DCON _{MS}	LF	WF				
	10	C6	90°	3	C6-SRDCN-00100-10	63.0	100.0	5.0	10	3.0	1.42	RCMT 10 T3 M0
	16	C6	90°	3	C6-SRDCN-00100-16	63.0	100.0	8.0	10	6.4	1.44	RCMT 16 06 M0

N = neutra

Componentes					
	CZC _{MS}	Parafuso	Calço	Parafuso do calço	Olhal
10	C6	5513 020-10	5322 110-01	5512 090-01	5691 045-01
16	C6	5513 020-26	5322 110-03	5512 090-06	5691 045-01

Para a lista completa de componentes, acesse www.sandvik.coromant.com



Unidade de corte CoroTurn® 107 para torneamento

Fixação por parafuso

Coromant Capto® - Refrigeração interna



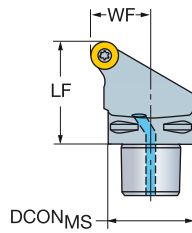

RCMT
RCGX-AL

Cx-SRSCR/L

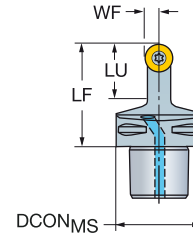

Cx-SRDCN

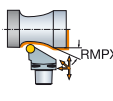

Código para pedido	CZC _{MS}	LU	RMPX	CNSC	Código para pedido	Dimensões, mm						MIID	
						DCON _{MS}	LF	WF	BAR	NM	KG		
	06	C4	12.0	90°	3	C4-SRDCN-00050-06A	40.0	50.0	3.0	10	0.9	0.40	RCMT 06 02 M0
		C5	12.0	90°	3	C5-SRDCN-00060-06A	50.0	60.0	3.0	10	0.9	0.71	RCMT 06 02 M0
	08	C4	16.0	90°	3	C4-SRDCN-00050-08A	40.0	50.0	4.0	10	1.4	0.36	RCMT 08 03 M0
		C5	16.0	90°	3	C5-SRDCN-00060-08A	50.0	60.0	4.0	10	1.4	0.59	RCMT 08 03 M0
	10	C4	25.0	90°	3	C4-SRDCN-00050-10A	40.0	50.0	5.0	10	3.0	0.33	RCMT 10 T3 M0
		C5	25.0	90°	3	C5-SRDCN-00060-10A	50.0	60.0	5.0	10	3.0	0.62	RCMT 10 T3 M0
		C6	25.0	90°	3	C6-SRDCN-00065-10A	63.0	65.0	5.0	10	3.0	1.00	RCMT 10 T3 M0
		C4	28.0	90°	3	C4-SRDCN-00050-12A	40.0	50.0	6.0	10	3.0	0.33	RCMT 12 04 M0
		C5	28.0	90°	3	C5-SRDCN-00060-12A	50.0	60.0	6.0	10	3.0	0.62	RCMT 12 04 M0
		C6	28.0	90°	3	C6-SRDCN-00065-12A	63.0	65.0	6.0	10	3.0	1.07	RCMT 12 04 M0
		C5	35.0	90°	3	C5-SRDCN-00060-16A	50.0	60.0	8.0	10	6.4	0.59	RCMT 16 06 M0
		C6	35.0	90°	3	C6-SRDCN-00065-16A	63.0	65.0	8.0	10	6.4	1.03	RCMT 16 06 M0
	06	C4	27°	3	C4-SRSCR-27050-06	40.0	50.0	27.0	10	0.9	0.40	RCMT 06 02 M0	
		C5	27°	3	C5-SRSCR/L-35060-06	50.0	60.0	35.0	10	0.9	0.72	RCMT 06 02 M0	
	08	C4	27°	3	C4-SRSCR/L-27050-08	40.0	50.0	27.0	10	1.4	0.36	RCMT 08 03 M0	
		C5	27°	3	C5-SRSCR/L-35060-08	50.0	60.0	35.0	10	1.4	0.70	RCMT 08 03 M0	
	10	C3	27°	3	C3-SRSCR-22040-10	32.0	40.0	22.0	10	3.0	0.22	RCMT 10 T3 M0	
		C4	27°	3	C4-SRSCR/L-27050-10	40.0	50.0	27.0	10	3.0	0.41	RCMT 10 T3 M0	
		C5	27°	3	C5-SRSCR/L-35060-10	50.0	60.0	35.0	10	3.0	0.75	RCMT 10 T3 M0	
		C6	27°	3	C6-SRSCR/L-45065-10	63.0	65.0	45.0	10	3.0	1.20	RCMT 10 T3 M0	
	12	C4	27°	3	C4-SRSCR/L-27050-12	40.0	50.0	27.0	10	3.0	0.40	RCMT 12 04 M0	
		C5	27°	3	C5-SRSCR/L-35060-12	50.0	60.0	35.0	10	3.0	0.75	RCMT 12 04 M0	
		C6	27°	3	C6-SRSCR/L-45065-12	63.0	65.0	45.0	10	3.0	1.24	RCMT 12 04 M0	
	16	C5	27°	3	C5-SRSCR/L-35060-16	50.0	60.0	35.0	10	6.4	0.70	RCMT 16 06 M0	
		C6	27°	3	C6-SRSCR/L-45065-16	63.0	65.0	45.0	10	6.4	1.27	RCMT 16 06 M0	
	20	C5	27°	3	C5-SRSCR/L-35060-20	50.0	60.0	35.0	10	9.5	0.86	RCMT 20 06 M0	
		C6	27°	3	C6-SRSCR/L-45065-20	63.0	65.0	45.0	10	9.5	1.31	RCMT 20 06 M0	

N = neutra, R = versão direita, L = versão esquerda

Componentes					
CZC _{MS}	Parafuso	Calço	Parafuso do calço	Olhal	
06	C4	5513 020-03			5691 034-01
06	C5	5513 020-03			5691 034-02
08	C4	5513 020-04			5691 034-01
08	C5	5513 020-04			5691 034-02
10	C3-C4	5513 020-10	5322 110-01	5512 090-01	5691 034-01
10	C5-C6	5513 020-10	5322 110-01	5512 090-01	5691 034-02
12	C4	5513 020-01	5322 110-02	5512 090-01	5691 034-01
12	C5-C6	5513 020-01	5322 110-02	5512 090-01	5691 034-02
16	C5-C6	5513 020-26	5322 110-03	5512 090-06	5691 034-02
20	C5-C6	5513 020-14	5322 110-04	5512 090-08	5691 034-02

Para a lista completa de componentes, acesse www.sandvik.coromant.com



Unidade de corte CoroTurn® 107 para torneamento

Fixação por parafuso

Coromant Capto® - Refrigeração de precisão

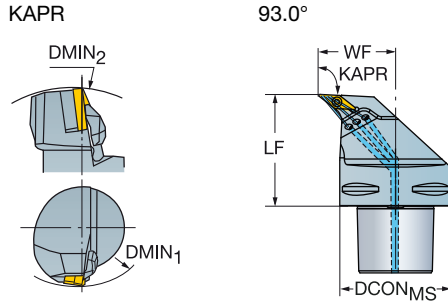

- VBMT, VBGT
VCGX, VCEX,
VCGT, VCET
- VBMM, VCMW

		Dimensões, mm											
		CZC _{MS}	DMIN ₁	RMPX	CNSC	Código para pedido	DCON _{MS}	LF	WF				MIID
	16	C6	85.0	50°	3	C6-SVUBR/L-45065-16HP	63.0	65.0	45.0	150	3.0	1.41	VBMT 16 04 08
		C8	100.0	50°	3	C8-SVUBR/L-55080-16HP	80.0	80.0	55.0	150	3.0	2.79	VBMT 16 04 08

R = versão direita, L = versão esquerda

Componentes				
Código para pedido	Parafuso da pastilha	Calço	Parafuso do calço	Olhal
C3-SVJBR/L2204011HPAB1	5513 020-03			5691 026-03
C4-SVJBR/L2705011HPAB1	5513 020-03			5691 026-03
C4-SVJBR/L-27050-16HP	5513 020-01	5322 270-01	5512 090-01	5691 026-13
C4-SVJBR/L-27050-16HPA	5513 020-01	5322 270-01	5512 090-01	5691 026-03
C5-SVJBR/L-35060-16HP	5513 020-01	5322 270-01	5512 090-01	5691 026-13
C5-SVJBR/L-35060-16HPA	5513 020-01	5322 270-01	5512 090-01	5691 026-03
C6-SVJBR/L-45065-16HP	5513 020-01	5322 270-01	5512 090-01	5691 026-13
C6-SVJBR/L-45065-16HPA	5513 020-01	5322 270-01	5512 090-01	5691 026-03
C6-SVUBR/L-45065-16HP	5513 020-01	5322 270-01	5512 090-01	5691 026-03
C8-SVJBR/L-55080-16HP	5513 020-01	5322 270-01	5512 090-01	5691 026-13
C8-SVUBR/L-55080-16HP	5513 020-01	5322 270-01	5512 090-01	5691 026-03

Para a lista completa de componentes, acesse www.sandvik.coromant.com



Unidade de corte CoroTurn® 107 para torneamento

Fixação por parafuso

Coromant Capto® - Refrigeração de precisão



- VBMT, VBGT
VCGX, VCEX,
VCGT, VCE T
- VBMM, VCMW

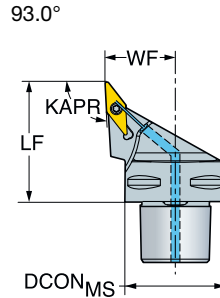
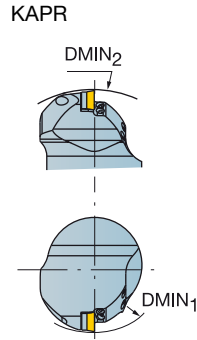

CZC _{MS}	DMIN ₁	DMIN ₂	RMPX	CNCS	Código para pedido	Dimensões, mm						MIID	
						DCON _{MS}	LF	WF	BAR	NM	KG		
11	C3	368.0	116.0	50°	3	C3-SVJBR/L-2204011B1C	32.0	40.0	22.0	150	0.9	0.18	VBMT 11 03 04
	C4	434.0	140.0	50°	3	C4-SVJBL-2705011B1C	40.0	50.0	27.0	150	0.9	0.36	VBMT 11 03 04
	C4	434.0	140.0	50°	3	C4-SVJBR-2705011B1C	40.0	50.0	27.0	150	3.0	0.36	VBMT 11 03 04
16	C4	270.0	140.0	50°	3	C4-SVJBR/L-27050-16C	40.0	50.0	27.0	150	3.0	0.33	VBMT 16 04 08
	C5	270.0	165.0	50°	3	C5-SVJBR/L-35060-16C	50.0	60.0	35.0	150	3.0	0.63	VBMT 16 04 08
	C6	270.0	190.0	50°	3	C6-SVJBR/L-45065-16C	63.0	65.0	45.0	150	3.0	1.14	VBMT 16 04 08
	C8	272.0	248.0	50°	3	C8-SVJBR/L-55080-16C	80.0	80.0	55.0	150	3.0	2.40	VBMT 16 04 08

N = neutra, R = versão direita, L = versão esquerda

Componentes						
MIID	Parafuso da pastilha	Parafuso do calço	Calço	Plugue inferior M4	Olhal para refrigeração	Parafuso da pastilha da broca
VBMT 11	5513 020-03	-	-	3213 010-256	5691 026-03	5680 084-15
VBMT 16	5513 020-01	5512 090-01	5322 270-01	3213 010-256	5691 026-03	5680 084-15

Para a lista completa de componentes, acesse www.sandvik.coromant.com



Unidade de corte CoroTurn® 107 para torneamento

Fixação por parafuso

Coromant Capto® - Refrigeração de precisão

B



KAPR

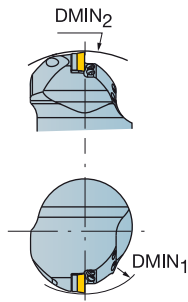

Cx-SVBN..C
72.5°

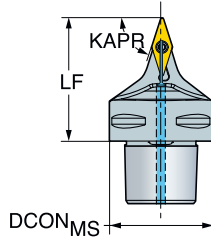

Cx-SVHBR/L..C
107.5°

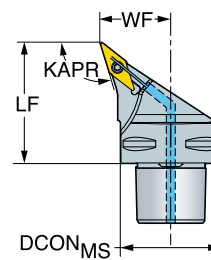

C



- VBMT, VBGT
VCGX, VCEX,
VCGT, VCET
- VBWM, VCMW

D

16	CZC _{MS}	DMIN ₁	DMIN ₂	RMPX	CNCS	Código para pedido	Dimensões, mm						MID
							DCON _{MS}	LF	WF	BAR	NM	KG	
	C4	124.0	140.0	35°	3	C4-SVHBR/L-27050-16C	40.0	50.0	27.0	150	3.0	0.35	VBMT 16 04 08
	C5	124.0	165.0	35°	3	C5-SVHBR/L-35060-16C	50.0	60.0	35.0	150	3.0	0.63	VBMT 16 04 08
	C6	134.0	190.0	35°	3	C6-SVHBR/L-45065-16C	63.0	65.0	45.0	150	3.0	1.14	VBMT 16 04 08
	C5	165.0	70°	3	3	C4-SVBN-00055-16C	50.0	60.0	0.6	150	3.0	0.31	VBMT 16 04 08
	C5	165.0	70°	3	3	C5-SVBN-00060-16C	50.0	60.0	0.6	150	3.0	0.55	VBMT 16 04 08
	C6	190.0	70°	3	3	C6-SVBN-00065-16C	63.0	65.0	0.6	150	3.0	0.97	VBMT 16 04 08

N = neutra, R = versão direita, L = versão esquerda

E

Componentes

Parafuso da pastilha	Parafuso do calço	Calço	Plugue inferior M4	Olhal para refrigeração	Parafuso da pastilha da broca
5513 020-01	5512 090-01	5322 270-01	3213 010-256	5691 026-03	5680 084-15

Para a lista completa de componentes, acesse www.sandvik.coromant.com

F

G

H



Unidade de corte CoroTurn® 107 para torneamento

Fixação por parafuso

Coromant Capto® - Refrigeração de precisão



-  VBMT, VBGT
VCGX, VCEX,
VCGT, VCE T
-  VB MW, VCMW

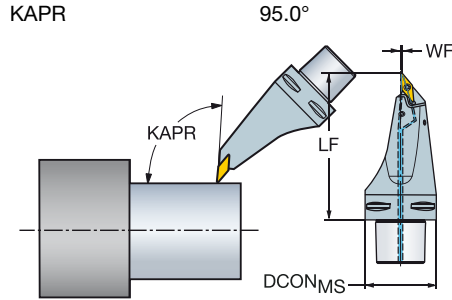

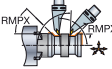
					Dimensões, mm						
	CZC _{MS}	RMPX	CNCS	Código para pedido	DCON _{MS}	LF	WF	BAR	NM	KG	MIID
								150	3.0	1.96	
16	C6	45°	3	C6-SVMBR/L-00130-16HP	63.0	130.0	1.2	150	3.0	1.96	VBMT 16 04 08
											

R = versão direita, L = versão esquerda

Componentes			
Parafuso da pastilha	Calço	Parafuso do calço	Olhal
5513 020-01	5322 270-01	5512 090-01	5691 026-03

Para a lista completa de componentes, acesse www.sandvik.coromant.com



Unidade de corte CoroTurn® 107 para torneamento

Fixação por parafuso

Coromant Capto® - Refrigeração interna

B



KAPR

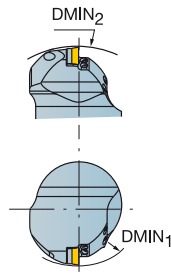

Cx-SVHBR/L
107.5°

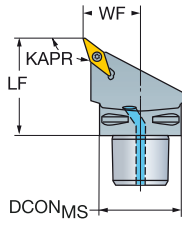

Cx-SVJBR/L
93.0°

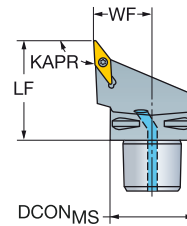

Cx-SVVBN
72.5°

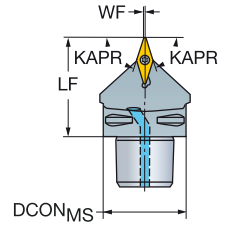

C



- VBMT, VBGT, VCGX, VCEX, VCGT, VCET
- VBWM, VCMW

D

CZC _{MS}	C3	DMIN ₁	DMIN ₂	RMPX	CNCS	Código para pedido	Dimensões, mm						MIID	
							DCON _{MS}	LF	WF	BAR	NM	KG		
	11	C3	35°	3	C3-SVHBR/L-22040-11	32.0	40.0	22.0	10	0.9	0.20	VBMT 11 02 04		
		C3	55.0	116.0	35°	3	C3-SVHBR/L-22040-11-B1	32.0	40.0	22.0	10	0.9	0.20	VBMT 11 03 04
		C4	35°	3	C4-SVHBR/L-27050-11	40.0	50.0	27.0	10	0.9	0.40	VBMT 11 02 04		
		C4	55.0	140.0	35°	3	C4-SVHBR/L-27050-11-B1	40.0	50.0	27.0	10	0.9	0.40	VBMT 11 03 04
		C5	35°	3	C5-SVHBR/L-35060-11	50.0	60.0	35.0	10	0.9	0.74	VBMT 11 02 04		
		C6	95.0	190.0	35°	3	C6-SVHBR/L-45065-16	63.0	65.0	45.0	10	3.0	1.12	VBMT 16 04 08
	16	C4	95.0	140.0	35°	3	C4-SVHBR/L-27050-16	40.0	50.0	27.0	10	3.0	0.38	VBMT 16 04 08
		C5	95.0	165.0	35°	3	C5-SVHBR/L-35060-16	50.0	60.0	35.0	10	3.0	0.64	VBMT 16 04 08
		C6	95.0	190.0	35°	3	C6-SVHBR/L-45065-16	63.0	65.0	45.0	10	3.0	1.12	VBMT 16 04 08
		C3	50°	3	C3-SVJBR/L-22040-11	32.0	40.0	22.0	10	0.9	0.19	VBMT 11 02 04		
		C3	105.0	116.0	50°	3	C3-SVJBR/L-22040-11-B1	32.0	40.0	22.0	10	0.9	0.20	VBMT 11 03 04
		C4	50°	3	C4-SVJBR/L-27050-11	40.0	50.0	27.0	10	0.9	0.38	VBMT 11 02 04		
		C4	105.0	140.0	50°	3	C4-SVJBR/L-27050-11-B1	40.0	50.0	27.0	10	0.9	0.38	VBMT 11 03 04
		C5	50°	3	C5-SVJBR/L-35060-11	50.0	60.0	35.0	10	0.9	0.74	VBMT 11 02 04		
		C6	155.0	190.0	50°	3	C6-SVJBR/L-45065-16	63.0	65.0	45.0	10	3.0	1.11	VBMT 16 04 08
		C4	155.0	140.0	50°	3	C4-SVJBR/L-27050-16	40.0	50.0	27.0	10	3.0	0.35	VBMT 16 04 08
		C5	155.0	165.0	50°	3	C5-SVJBR/L-35060-16	50.0	60.0	35.0	10	3.0	0.70	VBMT 16 04 08
		C6	155.0	190.0	50°	3	C6-SVJBR/L-45065-16	63.0	65.0	45.0	10	3.0	1.11	VBMT 16 04 08
	11	C3	116.0	70°	3	C3-SVVBN-00040-11-B1	32.0	40.0	0.3	10	0.9	0.18	VBMT 11 03 04	
	16	C4	140.0	70°	3	C4-SVVBN-00050-16	40.0	50.0	0.6	10	3.0	0.36	VBMT 16 04 08	
		C5	165.0	70°	3	C5-SVVBN-00060-16	50.0	60.0	0.6	10	3.0	0.56	VBMT 16 04 08	
		C6	190.0	70°	3	C6-SVVBN-00065-16	63.0	65.0	0.6	10	3.0	1.00	VBMT 16 04 08	

F

B1 = Para pastilha com espessura de 03 = 3.18 mm.

N = neutra, R = versão direita, L = versão esquerda

G

Componentes					
CZC _{MS}	Parafuso	Calço	Parafuso do calço	Olhal	
11	C3-C4	5513 020-03			5691 034-01
11	C5	5513 020-03			5691 034-02
16	C4	5513 020-01	5322 270-01	5512 090-01	5691 034-01
16	C5-C6	5513 020-01	5322 270-01	5512 090-01	5691 034-02

Para a lista completa de componentes, acesse www.sandvik.coromant.com

H



Unidade de corte CoroTurn® 107 para torneamento

Fixação por parafuso

Coromant Capto® - Refrigeração interna



- VBMT, VBGT, VCGX, VCGT, VCET
- VBMW, VCMW

KAPR

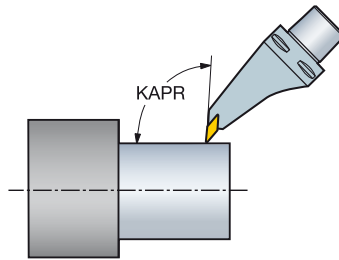

95.0°

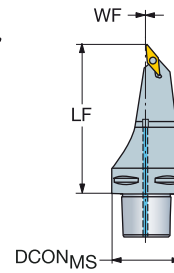

CZC _{MS}	RMPX	CNCS	Código para pedido	Dimensões, mm						MIID	
				DCON _{MS}	LF	WF	BAR	NM	KG		
16	C5	45°	3	C5-SVMBL-00115-16	50.0	115.0	1.2	10	3.0	1.00	VBMT 16 04 08
	C6	45°	3	C6-SVMBL-00130-16	63.0	130.0	1.2	10	3.0	1.77	VBMT 16 04 08
	C6	47°	3	C6-SVMBL-33120-16A	63.0	120.0	32.9	10	3.0	1.96	VBMT 16 04 08

L = versão esquerda

Componentes			
Parafuso	Calço	Parafuso do calço	Olhal
5513 020-01	5322 270-01	5512 090-01	5691 034-03

Para a lista completa de componentes, acesse www.sandvik.coromant.com



A

Ferramenta convencional CoroTurn® 107 para torneamento

Fixação por parafuso

Refrigeração de precisão

B

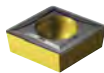
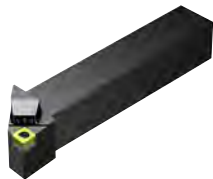

C

 CCMT

KAPR

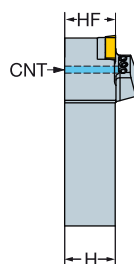

95.0°

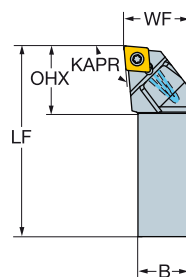

D

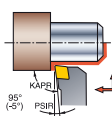

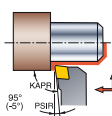
						Dimensões, mm										
		CZC _{MS}	OHX	CNSC	Código para pedido	B	H	LF	WF	HF	CNT	BAR	NM	KG	MIID	
		09	16 x 16	26.5	1	SCLCR/L 1616H 09HP	16.0	16.0	100.0	20.0	16.0	G 1/8-28	275	3.0	0.24	CCMT 09 T3 08

R = versão direita, L = versão esquerda

Componentes

Parafuso	Calço	Parafuso do calço	Olhal
5513 020-01	5322 232-01	5512 090-01	5691 026-13

Para a lista completa de componentes, acesse www.sandvik.coromant.com

F

G

H



A40



F2



E1



G1



H36



H10



H5

Ferramenta convencional CoroTurn® 107 para torneamento

Fixação por parafuso

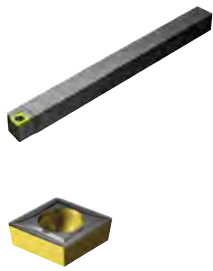

KAPR

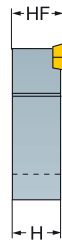

SCACR/L-S
90.0°

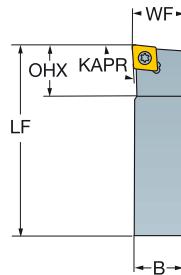

SCLCR/L
95.0°

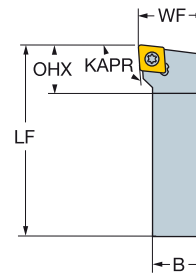

SCLCR/L-S
95.0°

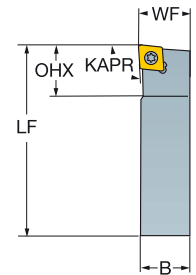

- CCMT, CCGT
CCGX, CCET
- CCMW

	CZC _{MS}	OHX	Código para pedido	Dimensões, mm								MIID
				B	H	LF	WF	HF	NM	KG		
	09	16 x 16	16.0	SCACR/L 1616K 09-S	16.0	16.0	125.0	16.0	16.0	3.0	0.28	CCMT 09 T3 08
	09	16 x 16	16.8	SCLCR/L 1616H 09	16.0	16.0	100.0	20.0	16.0	3.0	0.23	CCMT 09 T3 08
		20 x 20	17.8	SCLCR/L 2020K 09	20.0	20.0	125.0	25.0	20.0	3.0	0.42	CCMT 09 T3 08
	12	20 x 20	21.7	SCLCR/L 2020K 12	20.0	20.0	125.0	25.0	20.0	3.0	0.43	CCMT 12 04 08
		25 x 25	23.7	SCLCR/L 2525M 12	25.0	25.0	150.0	32.0	25.0	3.0	0.80	CCMT 12 04 08
	06	16 x 16	16.0	SCLCR/L 1616K 06-S	16.0	16.0	125.0	16.0	16.0	0.9	0.27	CCMT 06 02 04
	09	16 x 16	16.0	SCLCR/L 1616K 09-S	16.0	16.0	125.0	16.0	16.0	3.0	0.27	CCMT 09 T3 08

R = versão direita, L = versão esquerda

Código para pedido	Componentes		
	Parafuso	Calço	Parafuso do calço
SCLCR/L 1616K 06-S	5513 020-03		
SCACR/L 1616K 09-S	5513 020-09		
SCLCR/L 1616H 09	5513 020-01	5322 232-01	5512 090-01
SCLCR/L 1616K 09-S	5513 020-09		
SCLCR/L 2020K 09	5513 020-01	5322 232-01	5512 090-01
SCLCR/L 2020K 12	5513 020-18	5322 232-02	5512 090-03
SCLCR/L 2525M 12	5513 020-18	5322 232-02	5512 090-03

Para a lista completa de componentes, acesse www.sandvik.coromant.com



A

Ferramenta convencional CoroTurn® 107 para torneamento

Fixação por parafuso

Refrigeração de precisão

B



KAPR

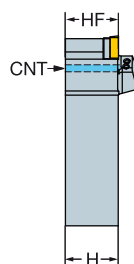

93.0°

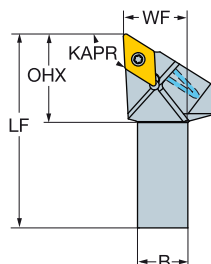

C

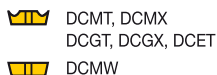

D

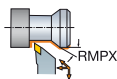

		Dimensões, mm														
		CZC _{MS}	RMPX	OHX	CNSC	Código para pedido	B	H	LF	WF	HF	CNT	BAR	NM	KG	MIID
11	16 x 16	27°	28.0	1	SDJCR/L 1616H 11HP	16.0	16.0	100.0	20.0	16.0	G 1/8-28	275	3.0	0.24	DCMT 11 T3 08	
	32 x 25	27°	28.0	1	SDJCR/L 3225P 11HP	25.0	32.0	170.0	32.0	32.0	G 1/8-28	275	3.0	1.06	DCMT 11 T3 08	

R = versão direita, L = versão esquerda

E

Componentes

Parafuso	Calço	Parafuso do calço	Olhal
5513 020-01	5322 263-01	5512 090-01	5691 026-13

Para a lista completa de componentes, acesse www.sandvik.coromant.com

F

G

H



A40



F2



E1



G1



H36



H10



H5

Ferramenta convencional CoroTurn® 107 para torneamento

Fixação por parafuso

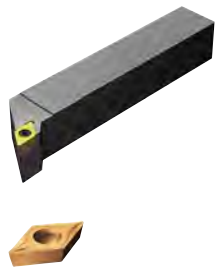

KAPR



SDJCR/L
93.0°

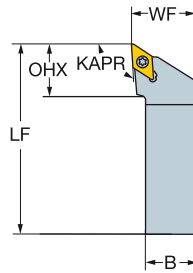

SDJCR/L-S
93.0°

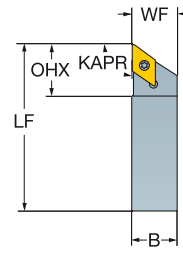

SDNCN
62.5°

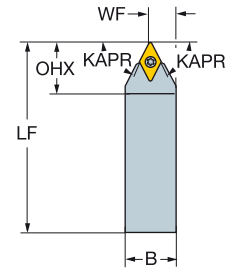

- DCMT, DCMX
DCGT, DCGX, DCET
- DCMW

		Dimensões, mm											
		CZC _{MS}	RMPX	OHX	Código para pedido	B	H	LF	WF	HF	NM	KG	MIID
	07	10 x 10	27°	15.7	SDJCR/L 1010E 07	10.0	10.0	70.0	12.0	10.0	0.9	0.04	DCMT 07 02 04
		16 x 16	27°	16.0	SDJCR/L 1616H 07	16.0	16.0	100.0	20.0	16.0	0.9	0.21	DCMT 07 02 04
		20 x 20	27°	17.4	SDJCR/L 2020K 07	20.0	20.0	125.0	25.0	20.0	0.9	0.40	DCMT 07 02 04
	11	16 x 16	27°	20.3	SDJCR/L 1616H 11	16.0	16.0	100.0	20.0	16.0	3.0	0.22	DCMT 11 T3 08
		16 x 16	27°	20.0	SDJCR/L 1616K 11-S	16.0	16.0	125.0	16.0	16.0	3.0	0.27	DCMT 11 T3 08
		20 x 20	27°	21.9	SDJCR/L 2020K 11	20.0	20.0	125.0	25.0	20.0	3.0	0.42	DCMT 11 T3 08
		25 x 25	27°	24.4	SDJCR/L 2525M 11	25.0	25.0	150.0	32.0	25.0	3.0	0.75	DCMT 11 T3 08
	07	10 x 10	57°	14.5	SDNCN 1010E 07	10.0	10.0	70.0	5.2	10.0	0.9	0.06	DCMT 07 02 04
	11	16 x 16	57°	21.9	SDNCN 1616H 11	16.0	16.0	100.0	8.5	16.0	3.0	0.20	DCMT 11 T3 08
		20 x 20	57°	21.9	SDNCN 2020K 11	20.0	20.0	125.0	10.5	20.0	3.0	0.40	DCMT 11 T3 08
	25 x 25	57°	22.2	SDNCN 2525M 11	25.0	25.0	150.0	13.0	25.0	3.0	0.71	DCMT 11 T3 08	

N = neutra, R = versão direita,
L = versão esquerda

Código para pedido	Componentes		
	Parafuso	Calço	Parafuso do calço
SDJCR/L 1010E 07	5513 020-03		
SDNCN 1010E 07	5513 020-03		
SDJCR/L 1616H 07	5513 020-03		
SDJCR/L 2020K 07	5513 020-03		
SDJCR/L 1616H 11	5513 020-01	5322 263-01	5512 090-01
SDJCR/L 1616K 11-S	5513 020-09		
SDNCN 1616H 11	5513 020-01	5322 263-01	5512 090-01
SDJCR/L 2020K 11	5513 020-01	5322 263-01	5512 090-01
SDNCN 2020K 11	5513 020-01	5322 263-01	5512 090-01
SDJCR/L 2525M 11	5513 020-01	5322 263-01	5512 090-01
SDNCN 2525M 11	5513 020-01	5322 263-01	5512 090-01

Para a lista completa de componentes, acesse www.sandvik.coromant.com



A

Ferramenta convencional CoroTurn® 107 para torneamento

Fixação por parafuso

B

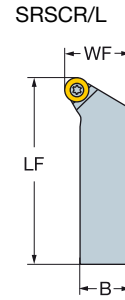
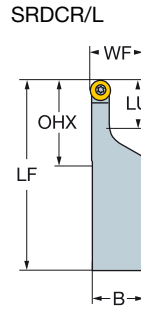
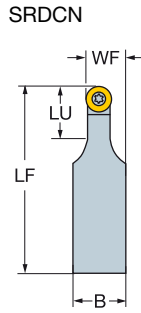

C

RCMT
RCGX-AL

D

Código para pedido	Dimensões, mm				Código para pedido	Dimensões, mm				NM	KG	MID
	CZC _{MS}	LU	RMPX	OHX		B	H	LF	WF			
SRDCN 1616H 08	08	16 x 16	16.0	90°	16.0	16.0	100.0	12.0	16.0	1.4	0.17	RCMT 08 03 MO
SRDCN 2020K 10-A	10	20 x 20	25.0	90°	20.0	20.0	125.0	15.0	20.0	3.0	0.40	RCMT 10 T3 MO
	25 x 25	25.0	90°	25.0	25.0	150.0	17.5	25.0	3.0	0.66	RCMT 10 T3 MO	
	32 x 25	28.0	90°	28.0	25.0	170.0	17.5	32.0	3.0	1.00	RCMT 10 T3 MO	
SRDCN 2020K 12-A	12	20 x 20	25.0	90°	20.0	20.0	125.0	16.0	20.0	3.0	0.40	RCMT 12 04 MO
	25 x 25	28.0	90°	28.0	25.0	150.0	18.5	25.0	3.0	0.67	RCMT 12 04 MO	
	32 x 25	28.0	90°	28.0	25.0	170.0	18.5	32.0	3.0	1.00	RCMT 12 04 MO	
SRDCN 2525M 12-A	16	25 x 25	35.0	90°	25.0	25.0	150.0	20.5	32.0	6.4	0.64	RCMT 16 06 MO
	32 x 25	35.0	90°	35.0	25.0	170.0	20.5	32.0	6.4	1.00	RCMT 16 06 MO	
	20	32 x 32	40.0	90°	32.0	32.0	170.0	26.0	32.0	9.5	1.24	RCMT 20 06 MO
SRDCR/L 3225P 05-A	05	32 x 25	20.0	90°	25.0	32.0	170.0	25.5	32.0	0.9	0.95	RCMT 05 02 MO
	06	20 x 20	20.0	90°	20.0	20.0	125.0	20.5	20.0	0.9	0.35	RCMT 06 02 MO
	32 x 25	20.0	90°	35.0	25.0	32.0	170.0	25.5	32.0	0.9	1.00	RCMT 06 02 MO
	08	20 x 20	20.0	90°	32.0	20.0	20.0	125.0	20.5	20.0	1.4	0.36
SRDCR/L 2525M 08-A	25 x 25	20.0	90°	35.0	25.0	25.0	150.0	25.5	25.0	1.4	0.68	RCMT 08 03 MO
	32 x 25	20.0	90°	35.0	25.0	32.0	170.0	25.5	32.0	1.4	1.00	RCMT 08 03 MO
	05	32 x 25	20.0	90°	32.0	25.0	32.0	170.0	32.0	0.9	1.01	RCMT 05 02 MO
SRSCR/L 3225P 05	06	32 x 25	27°	32.0	25.0	32.0	170.0	32.0	32.0	0.9	1.01	RCMT 06 02 MO
	08	32 x 25	27°	32.0	25.0	32.0	170.0	32.0	32.0	1.4	1.02	RCMT 08 03 MO
	10	20 x 20	27°	24.4	20.0	20.0	125.0	25.0	20.0	3.0	0.42	RCMT 10 T3 MO
	25 x 25	27°	28.0	25.0	25.0	150.0	32.0	25.0	3.0	0.80	RCMT 10 T3 MO	
	12	25 x 25	27°	28.0	25.0	25.0	150.0	32.0	25.0	3.0	0.80	RCMT 12 04 MO
	32 x 25	27°	32.0	25.0	32.0	170.0	32.0	32.0	3.0	1.05	RCMT 12 04 MO	
SRSCR/L 3225P 16	16	32 x 25	27°	32.0	25.0	32.0	170.0	32.0	32.0	6.4	1.07	RCMT 16 06 MO
	20	32 x 32	27°	32.0	32.0	32.0	170.0	40.0	32.0	9.5	1.30	RCMT 20 06 MO

N = neutra, R = versão direita, L = versão esquerda

F

Código para pedido	Componentes			
	CZC _{MS}	Parafuso	Calço	Parafuso do calço
05	32 x 25	5513 020-05		
06	20 x 20-32 x 25	5513 020-03		
08	16 x 16-32 x 25	5513 020-04		
10	20 x 20-32 x 25	5513 020-10	5322 110-01	5512 090-01
12	20 x 20-32 x 25	5513 020-01	5322 110-02	5512 090-01
16	25 x 25-32 x 25	5513 020-26	5322 110-03	5512 090-06
20	32 x 32	5513 020-14	5322 110-04	5512 090-08

Para a lista completa de componentes, acesse www.sandvik.coromant.com

G

H



Ferramenta convencional CoroTurn® 107 para torneamento

Fixação por parafuso

Refrigeração de precisão



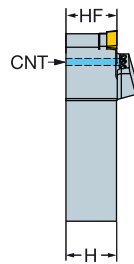

 SCMT

KAPR

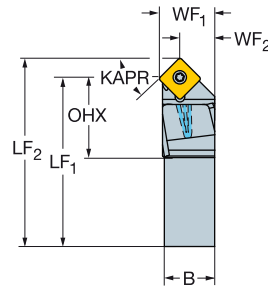

45.0°



		Dimensões, mm														
		CZC _{MS}	OHX	CNSC	Código para pedido	B	H	LPR	LF	WF	HF	CNT	BAR	NM	KG	MIID
		09	16 x 16	21.2	1	SSDCR/L 1616H 09HP	16.0	16.0	101.4	95.3	17.0	16.0	G 1/8-28	275	3.0	0.22

R = versão direita, L = versão esquerda

Componentes			
Parafuso	Calço	Parafuso do calço	Olhal
5513 020-01	5322 420-01	5512 090-01	5691 026-23

Para a lista completa de componentes, acesse www.sandvik.coromant.com



A40



F2



E1



G1



H36



H10



H5



Ferramenta convencional CoroTurn® 107 para torneamento

Fixação por parafuso

B

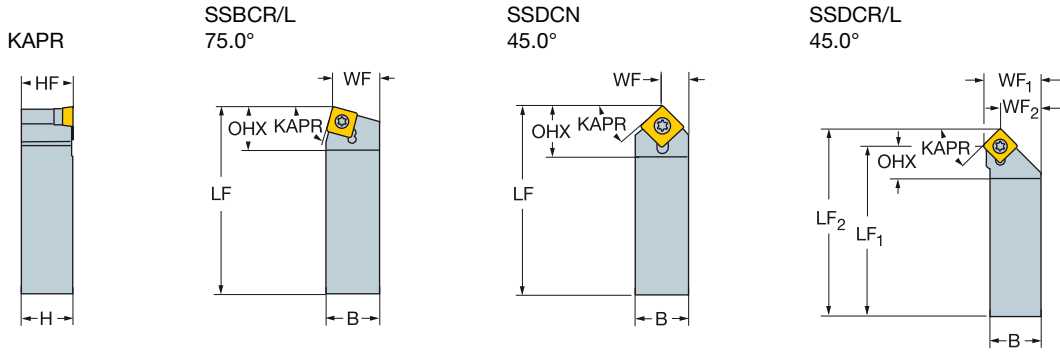
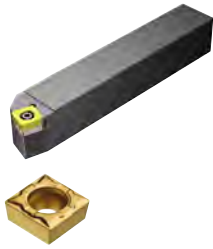

C

- SCMT, SCGX
- SCMW

D

Diagrama	CZC _{MS}	RMPX	OHX	Código para pedido	Dimensões, mm							MIID		
					B	H	LPR	LF	WF	HF	NM		KG	
	09	16 x 16	10°	15.3	SSBCR/L 1616H 09	16.0	16.0	100.0	13.0	16.0	3.0	0.22	SCMT 09 T3 08	
	12	25 x 25	10°	20.1	SSBCR/L 2525M 12	25.0	25.0	150.0	22.0	25.0	3.0	0.75	SCMT 12 04 08	
	09	16 x 16	45°	15.1	SSDCN 1616H 09	16.0	16.0	100.0	8.0	16.0	3.0	0.21	SCMT 09 T3 08	
	12	25 x 25	45°	20.1	SSDCN 2525M 12	25.0	25.0	150.0	14.0	25.0	3.0	0.72	SCMT 12 04 08	
	09	16 x 16	0°	9.5	SSDCR/L 1616H 09	16.0	16.0	100.0	93.9	17.0	16.0	3.0	0.21	SCMT 09 T3 08
		20 x 20	0°	12.4	SSDCR/L 2020K 09	20.0	20.0	125.0	118.9	22.0	20.0	3.0	0.40	SCMT 09 T3 08
	12	20 x 20	0°	13.9	SSDCR/L 2020K 12	20.0	20.0	125.0	116.7	22.0	20.0	3.0	0.40	SCMT 12 04 08
		25 x 25	0°	13.9	SSDCR/L 2525M 12	25.0	25.0	150.0	141.7	27.0	25.0	3.0	0.72	SCMT 12 04 08

N = neutra, R = versão direita, L = versão esquerda

F

Componentes					
Diagrama	CZC _{MS}	Parafuso	Calço	Parafuso do calço	
	09	16 x 16-20 x 20	5513 020-01	5322 420-01	5512 090-01
	12	20 x 20-25 x 25	5513 020-18	5322 420-02	5512 090-03

Para a lista completa de componentes, acesse www.sandvik.coromant.com

G

H



Ferramenta convencional CoroTurn® 107 para torneamento

Fixação por parafuso



- TCMT, TCMX, TCGT, TCGX
- TCEX
- TCMW

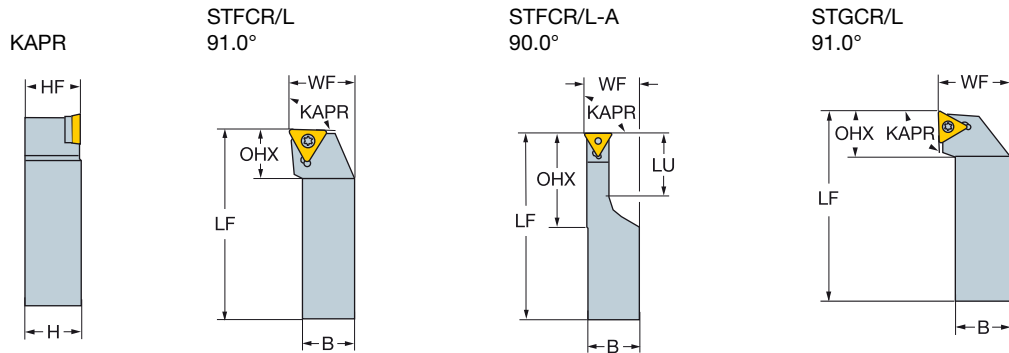

	CZC _{MS}	LU	OHX	Código para pedido	Dimensões, mm								MIID
					B	H	LF	WF	HF	NM	KG		
	11	16 x 16	14.9	STFCR/L 1616H 11	16.0	16.0	100.0	20.0	16.0	0.9	0.22	TCMT 11 02 04	
	16	16 x 16	19.9	STFCR/L 1616H 16	16.0	16.0	100.0	20.0	16.0	3.0	0.23	TCMT 16 T3 08	
		20 x 20	21.3	STFCR/L 2020K 16	20.0	20.0	125.0	25.0	20.0	3.0	0.42	TCMT 16 T3 08	
		25 x 25	22.8	STFCR/L 2525M 16	25.0	25.0	150.0	32.0	25.0	3.0	0.80	TCMT 16 T3 08	
	11	20 x 20	25.0	37.0	STFCR/L 2020K 11-A	20.0	20.0	125.0	20.8	20.0	0.9	0.36	TCMT 11 02 04
		20 x 20	25.0	37.0	STFCR/L 2020K 11-AB1	20.0	20.0	125.0	20.8	20.0	0.9	0.40	TCMT 11 03 04
	16	25 x 25	35.0	47.0	STFCR/L 2525M 16-A	25.0	25.0	150.0	25.9	25.0	3.0	0.68	TCMT 16 T3 08
	11	16 x 16	14.1	STGCR/L 1616H 11	16.0	16.0	100.0	20.0	16.0	0.9	0.22	TCMT 11 02 04	
		16 x 16	14.1	STGCR/L 1616H 11-B1	16.0	16.0	100.0	20.0	16.0	0.9	0.22	TCMT 11 03 04	
	16	16 x 16	20.1	STGCR/L 1616H 16	16.0	16.0	100.0	20.0	16.0	3.0	0.23	TCMT 16 T3 08	
		20 x 20	20.4	STGCR/L 2020K 16	20.0	20.0	125.0	25.0	20.0	3.0	0.42	TCMT 16 T3 08	
		25 x 25	20.9	STGCR/L 2525M 16	25.0	25.0	150.0	32.0	25.0	3.0	0.80	TCMT 16 T3 08	

B1 = Para pastilha com espessura de 03 = 3.18 mm.

R = versão direita, L = versão esquerda

Componentes				
	CZC _{MS}	Parafuso	Calço	Parafuso do calço
	11	16 x 16-20 x 20	5513 020-03	
	16	16 x 16-25 x 25	5513 020-01	5322 320-01
				5512 090-01

Para a lista completa de componentes, acesse www.sandvik.coromant.com



A

TORNEAMENTO GERAL

Ferramentas externas

Ferramenta convencional CoroTurn® 107 para torneamento

Fixação por parafuso

B

KAPR

STDCR/L
45.0°

STJCR/L-S
93.0°

STTCR/L
60.0°

C

D

E

	CZC _{MS}	RMPX	OHX	Código para pedido	Dimensões, mm							MIID		
					B	H	LPR	LF	WF	HF	NM		KG	
	16	16 x 16	45°	21.0	STDCR/L 1616H 16	16.0	16.0	100.0	100.0	6.8	16.0	3.0	0.21	TCMT 16 T3 08
	11	16 x 16	0°	16.0	STJCR/L 1616K 11-S	16.0	16.0	125.0	16.0	16.0	0.9	0.27	TCMT 11 02 04	
	11	16 x 16	30°	12.9	STTCR/L 1616H 11	16.0	16.0	100.0	13.0	16.0	0.9	0.21	TCMT 11 02 04	
	16	16 x 16	30°	12.9	STTCR/L 1616H 11-B1	16.0	16.0	100.0	13.0	16.0	0.9	0.21	TCMT 11 03 04	
	16	20 x 20	30°	21.2	STTCR/L 2020K 16	20.0	20.0	125.0	17.0	20.0	3.0	0.41	TCMT 16 T3 08	
		25 x 25	30°	21.2	STTCR/L 2525M 16	25.0	25.0	150.0	22.0	25.0	3.0	0.74	TCMT 16 T3 08	

B1 = Para pastilha com espessura de 03 = 3.18 mm.

R = versão direita, L = versão esquerda

F

Componentes				
	CZC _{MS}	Parafuso	Calço	Parafuso do calço
	11	16 x 16	5513 020-03	
	16	16 x 16-25 x 25	5513 020-01	5322 320-01 5512 090-01

Para a lista completa de componentes, acesse www.sandvik.coromant.com

G

H

A 80

Ferramenta convencional CoroTurn® 107 para torneamento

Fixação por parafuso

Refrigeração de precisão



KAPR

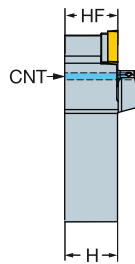

93.0°

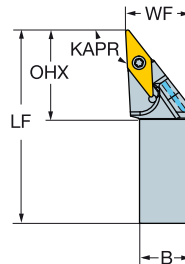

- VBMT, VBGT
VCGX,
VCGT, VCET
- VBMW, VCMW

		Dimensões, mm													
	CZC _{MS}	RMPX	OHX	CNCS	Código para pedido	B	H	LF	WF	HF	CNT	BAR	NM	KG	MIID
												275	3.0	1.01	VBMT 16 04 08
16	32 x 25	44°	37.6	1	SVJBR/L 3225P 16HP	25.0	32.0	170.0	32.0	32.0	G 1/8-28	275	3.0	1.01	VBMT 16 04 08

R = versão direita, L = versão esquerda

Componentes			
Parafuso	Calço	Parafuso do calço	Olhal
5513 020-01	5322 270-01	5512 090-01	5691 026-13

Para a lista completa de componentes, acesse www.sandvik.coromant.com



Ferramenta convencional CoroTurn® 107 para torneamento

Fixação por parafuso

B

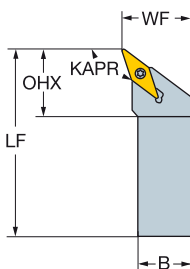
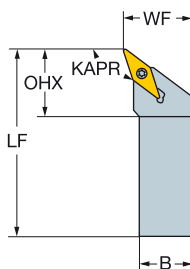
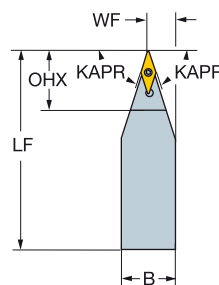

KAPR

SVHBR/L
107.5°SVHCR/L
107.5°SVBN
72.5°

C



D

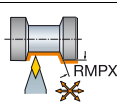
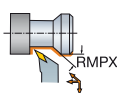

				Dimensões, mm										
				Código para pedido	B	H	LF	WF	HF			MIID		
	16	20 x 20	35°	27.6	SVHBR/L 2020K 16	20.0	20.0	125.0	25.0	20.0	3.0	0.40	VBMT 16 04 08	
		25 x 25	35°	27.6	SVHBR/L 2525M 16	25.0	25.0	150.0	32.0	25.0	3.0	0.71	VBMT 16 04 08	
		32 x 25	35°	27.6	SVHBR/L 3225P 16	25.0	32.0	170.0	32.0	32.0	3.0	1.04	VBMT 16 04 08	
	22	25 x 25	35°	35.2	SVHCR/L 2525M 22-R2	25.0	25.0	150.0	32.0	25.0	3.0	0.72	VCMT 22 05 20	
	11	16 x 16	70°	21.1	SVBN 1616H 11	16.0	16.0	100.0	8.3	16.0	0.9	0.19	VBMT 11 02 04	
		20 x 20	70°	21.1	SVBN 2020K 11-B1	20.0	20.0	125.0	10.3	20.0	0.9	0.37	VBMT 11 03 04	
		25 x 25	70°	21.1	SVBN 2525M 11-B1	25.0	25.0	150.0	12.8	25.0	0.9	0.66	VBMT 11 03 04	
		16	20 x 20	70°	31.5	SVBN 2020K 16	20.0	20.0	125.0	10.6	20.0	3.0	0.40	VBMT 16 04 08
			25 x 25	70°	31.5	SVBN 2525M 16	25.0	25.0	150.0	13.1	25.0	3.0	0.68	VBMT 16 04 08
			32 x 25	70°	31.5	SVBN 3225P 16	25.0	32.0	170.0	13.1	32.0	3.0	1.00	VBMT 16 04 08
	11	16 x 16	70°	21.0	SVBN 1616K 11-S-B1	16.0	16.0	125.0	8.3	16.0	0.9	0.24	VBMT 11 03 04	

E

B1 = Para pastilha com espessura de 03 = 3.18 mm.

N = neutra, R = versão direita, L = versão esquerda

Componentes			
	Parafuso	Calço	Parafuso do calço
11	5513 020-03		
16	5513 020-01	5322 270-01	5512 090-01
22	5513 020-18	5322 270-03	5512 090-03

Para a lista completa de componentes, acesse www.sandvik.coromant.com

F

Quando usar a pastilha VCGX 22 05 30-AL com raio de 3.0 mm, junto com calço 5322 270-04, o porta-ferramenta deve ser modificado. Veja figura.

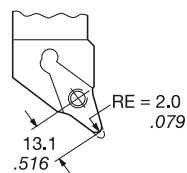

G

H



Ferramenta convencional CoroTurn® 107 para torneamento

Fixação por parafuso



- VBMT, VBGT
VCGX, VCEX,
VCGT, VCET
- VBMT, VCMW

KAPR



SVJBR/L
93.0°

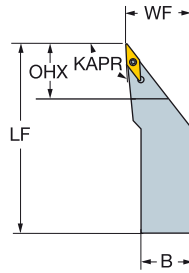

SVJBR/L-S
93.0°

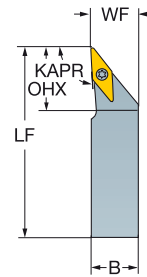

		Dimensões, mm										MIID	
		CZC _{MS}	RMPX	OHX	Código para pedido	B	H	LF	WF	HF	NM		KG
	11	16 x 16	50°	21.2	SVJBR/L 1616H 11	16.0	16.0	100.0	20.0	16.0	0.9	0.20	VBMT 11 02 04
		16 x 16	50°	21.2	SVJBR/L 1616H 11-B1	16.0	16.0	100.0	20.0	16.0	0.9	0.20	VBMT 11 03 04
		20 x 20	50°	21.2	SVJBR/L 2020K 11	20.0	20.0	125.0	25.0	20.0	0.9	0.40	VBMT 11 02 04
		20 x 20	50°	21.2	SVJBR/L 2020K 11-B1	20.0	20.0	125.0	25.0	20.0	0.9	0.26	VBMT 11 03 04
		25 x 25	50°	21.2	SVJBR/L 2525M 11	25.0	25.0	150.0	32.0	25.0	0.9	0.69	VBMT 11 02 04
		25 x 25	50°	21.2	SVJBR/L 2525M 11-B1	25.0	25.0	150.0	32.0	25.0	0.9	0.69	VBMT 11 03 04
	16	20 x 20	50°	31.1	SVJBR/L 2020K 16	20.0	20.0	125.0	25.0	20.0	3.0	0.38	VBMT 16 04 08
		25 x 25	50°	31.5	SVJBR/L 2525M 16	25.0	25.0	150.0	32.0	25.0	3.0	0.69	VBMT 16 04 08
		32 x 25	50°	31.5	SVJBR/L 3225P 16	25.0	32.0	170.0	32.0	32.0	3.0	1.01	VBMT 16 04 08
	11	16 x 16	50°	26.0	SVJBR/L 1616K 11-S	16.0	16.0	125.0	16.0	16.0	0.9	0.20	VBMT 11 02 04
	16 x 16	50°	26.0	SVJBR/L 1616K 11-S-B1	16.0	16.0	125.0	16.0	16.0	0.9	0.25	VBMT 11 03 04	
	16	16 x 16	50°	40.0	SVJBR/L 1616K 16-S	16.0	16.0	125.0	16.0	16.0	3.0	0.28	VBMT 16 04 08

B1 = Para pastilha com espessura de 03 = 3.18 mm.

R = versão direita, L = versão esquerda

Componentes				
	CZC _{MS}	Parafuso	Calço	Parafuso do calço
	11	16 x 16-25 x 25	5513 020-03	
	16	16 x 16	5513 020-09	
	16	20 x 20-32 x 25	5513 020-01	5322 270-01

Para a lista completa de componentes, acesse www.sandvik.coromant.com



A

Ferramenta convencional CoroTurn® 107 QS para torneamento

Fixação por parafuso

Refrigeração de precisão

B

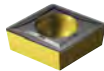

 CCMT

KAPR

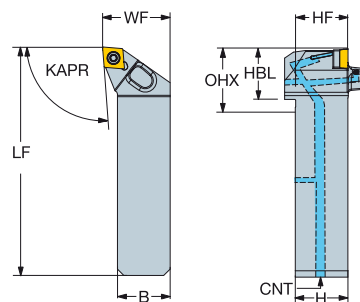
95.0°

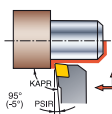

C

D	CZC _{MS}	OHX	CNSC	Código para pedido	Dimensões, mm								BAR NM KG			MIID
					B	H	HBL	LF	WF	HF	CNT					
	09	20 x 20	44.0	3	QS-SCLCR/L 2020 09C	20.0	20.0	24.0	93.0	25.0	20.0	G 1/8-28	150	3.0	0.26	CCMT 09 T3 08
		25 x 25	49.0	3	QS-SCLCR/L 2525 09C	25.0	25.0	24.0	108.0	32.0	25.0	G 1/8-28	150	3.0	0.48	CCMT 09 T3 08

R = versão direita, L = versão esquerda

E

Componentes						
Parafuso da pastilha	Parafuso do calço	Calço	Olhal	Plugue	Plugue	Plugue
5513 020-01	5512 090-01	5322 232-01	5691 026-13	5512 104-01	3214 013-01	3214 012-01

Para a lista completa de componentes, acesse www.sandvik.coromant.com

F

G

H



A40



F2



E1



G1



H36



H5

Ferramenta convencional CoroTurn® 107 QS para torneamento

Fixação por parafuso

Refrigeração de precisão

KAPR

93.0°

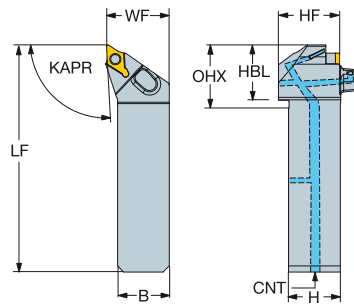

- DCMT, DCMX
DCGT, DCGX, DCET
- DCMW

		Dimensões, mm															
	11	CZC _{MS}	RMPX	OHX	CNCS	Código para pedido	B	H	HBL	LF	WF	HF	CNT	BAR	NM	KG	MIID
		25 x 25	27°	54.0	3	QS-SDJCR/L 2525 11C	25.0	25.0	29.0	113.0	32.0	25.0	G 1/8-28	150	3.0	0.49	DCMT 11 T3 08

R = versão direita, L = versão esquerda

Componentes						
Parafuso da pastilha	Parafuso do calço	Calço	Olhal	Plugue	Plugue	Plugue
5513 020-01	5512 090-01	5322 263-01	5691 026-13	5512 104-01	3214 013-01	3214 012-01

Para a lista completa de componentes, acesse www.sandvik.coromant.com



A

Ferramenta convencional CoroTurn® 107 QS para torneamento

Fixação por parafuso

Refrigeração de precisão

KAPR

45.0°

B

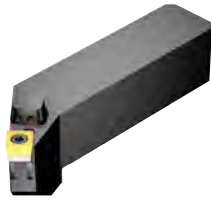

SCMT

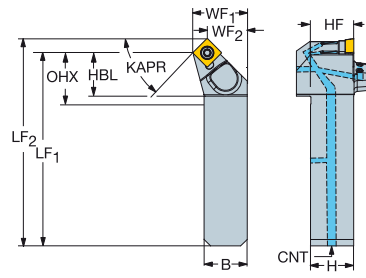

C

		Dimensões, mm														
		CZC _{MS}	OHX	CNSC	Código para pedido	B	H	HBL	LF	WF	HF	CNT	BAR	NM	KG	MIID
	09	20 x 20	52.5	3	QS-SSDCR/L 2020 09C	20.0	20.0	27.5	90.1	25.0	20.0	G 1/8-28	150	3.0	0.27	SCMT 09 T3 08
		25 x 25	53.5	3	QS-SSDCR/L 2525 09C	25.0	25.0	28.5	106.1	32.0	25.0	G 1/8-28	150	3.0	0.48	SCMT 09 T3 08

R = versão direita, L = versão esquerda

D

Componentes						
Parafuso da pastilha	Parafuso do calço	Calço	Olhal	Plugue	Plugue	Plugue
5513 020-01	5512 090-01	5322 263-01	5691 026-13	5512 104-01	3214 013-01	3214 012-01

Para a lista completa de componentes, acesse www.sandvik.coromant.com

E

F

G

H



Ferramenta convencional CoroTurn® 107 QS para torneamento

Fixação por parafuso

Refrigeração de precisão

KAPR

93.0°

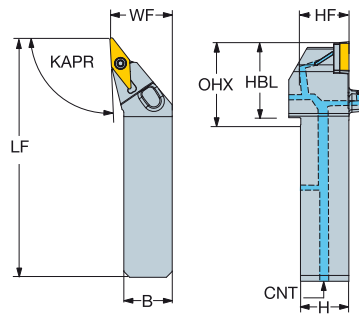

- VBMT, VBGT, VCGX, VCGT, VCET
- VBMW, VCMW

		Dimensões, mm															
	16	CZC _{MS}	RMPX	OHX	CN5C	Código para pedido	B	H	HBL	LF	WF	HF	CNT	BAR	NM	KG	MIID
														20 x 20	44°	59.0	3
		25 x 25	44°	64.0	3	QS-SVJBR/L 2525 16C	25.0	25.0	39.0	123.0	32.0	25.0	G 1/8-28	150	3.0	0.51	VBMT 16 04 08

R = versão direita, L = versão esquerda

Componentes						
Parafuso da pastilha	Parafuso do calço	Calço	Olhal	Plugue	Plugue	Plugue
5513 020-01	5512 090-01	5322 270-01	5691 026-13	5512 104-01	3214 013-01	3214 012-01

Para a lista completa de componentes, acesse www.sandvik.coromant.com



Ferramentas CoroTurn® 107 para usinagem interna

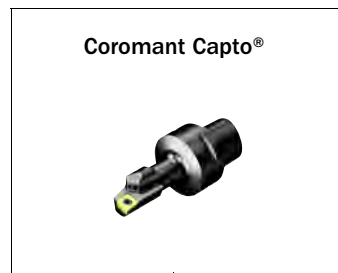

Ferramentas para formatos da pastilha

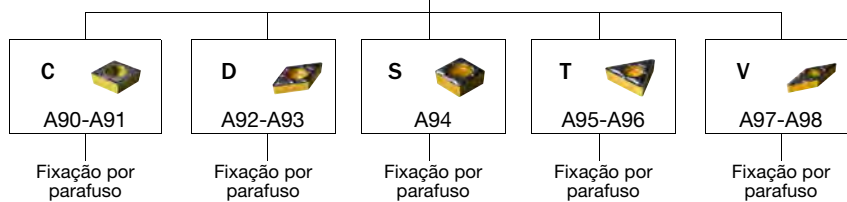

Ferramentas para formatos da pastilha

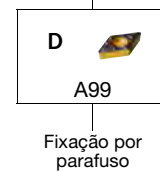

Ferramentas para formatos da pastilha



Ferramentas para formatos da pastilha

Ferramentas CoroTurn® 107 para usinagem interna

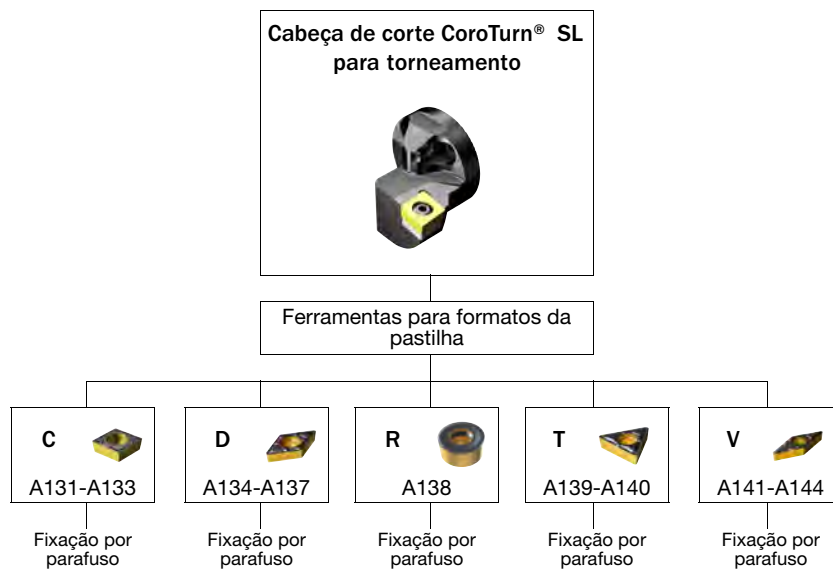
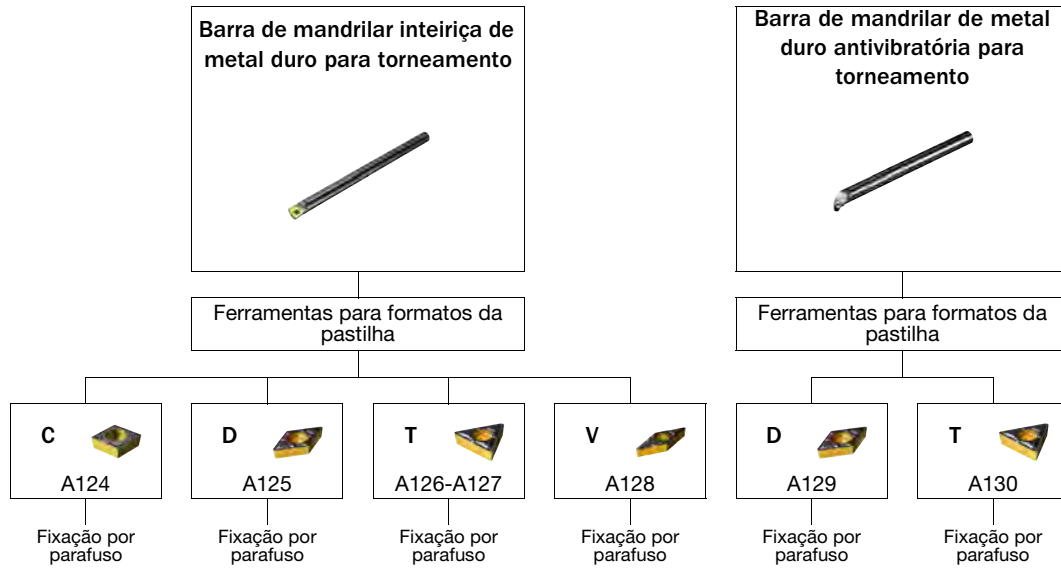

A

Unidade de corte CoroTurn® 107 para torneamento

Fixação por parafuso

Coromant Capto® - Refrigeração de precisão

KAPR

95.0°

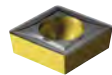

CCMT, CCGT
CCGX, CCET

CCMW

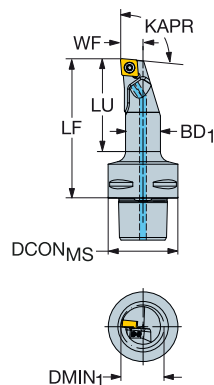

B

C

D

Código para pedido	CZC _{MS}	DMIN ₁	LU	CNSC	Código para pedido	Dimensões, mm						MIID	
						DCON _{MS}	BD	LF	WF	BAR	NM		KG
09	C3	21.5	48.0	3	C3-SCLCR/L-11065-09HP	32.0	16.0	65.0	11.0	150	3.0	0.22	CCMT 09 T3 08
	C4	21.5	47.0	3	C4-SCLCR/L-11070-09HP	40.0	16.0	70.0	11.0	150	3.0	0.36	CCMT 09 T3 08
	C4	25.0	57.0	3	C4-SCLCR/L-13080-09HP	40.0	20.0	80.0	13.0	150	3.0	0.41	CCMT 09 T3 08
	C5	21.5	46.0	3	C5-SCLCR/L-11070-09HP	50.0	16.0	70.0	11.0	150	3.0	0.56	CCMT 09 T3 08
	C5	25.0	56.0	3	C5-SCLCR/L-13080-09HP	50.0	20.0	80.0	13.0	150	3.0	0.61	CCMT 09 T3 08
12	C4	32.0	69.0	3	C4-SCLCR/L-17090-12HP	40.0	25.0	90.0	17.0	150	3.0	0.50	CCMT 12 04 08
	C5	32.0	67.0	3	C5-SCLCR/L-17090-12HP	50.0	25.0	90.0	17.0	150	3.0	0.69	CCMT 12 04 08

R = versão direita, L = versão esquerda

E

Código para pedido	Componentes	
	Parafuso da pastilha	Olhal
C3-SCLCR/L-11065-09HP	5513 020-09	5691 026-13
C4-SCLCR/L-11070-09HP	5513 020-09	5691 026-13
C4-SCLCR/L-13080-09HP	5513 020-09	5691 026-13
C5-SCLCR/L-11070-09HP	5513 020-09	5691 026-13
C5-SCLCR/L-13080-09HP	5513 020-09	5691 026-13
C4-SCLCR/L-17090-12HP	5513 020-17	5691 026-13
C5-SCLCR/L-17090-12HP	5513 020-17	5691 026-13

Para a lista completa de componentes, acesse www.sandvik.coromant.com

F

G

H



Unidade de corte CoroTurn® 107 para torneamento

Fixação por parafuso

Coromant Capto® - Refrigeração interna

KAPR

95.0°

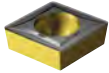

- CCMT, CCGT
CCGX, CCET
- CCMW

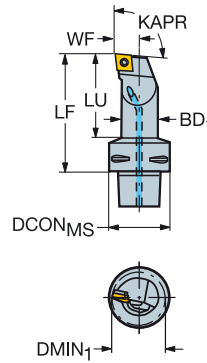

Código para pedido	CZC _{MS}	DMIN ₁	LU	CNSC	Código para pedido	Dimensões, mm						MIID	
						DCON _{MS}	BD	LF	WF	BAR	NM		KG
09	C3	32.0	74.0	3	C3-SCLCL-17090-09	32.0	25.0	90.0	17.0	10	3.0	0.38	CCMT 09 T3 08
	C3	20.0	48.0	3	C3-SCLCR/L-11065-09	32.0	16.0	65.0	11.0	10	3.0	0.21	CCMT 09 T3 08
	C3	25.0	58.0	3	C3-SCLCR/L-13075-09	32.0	20.0	75.0	13.0	10	3.0	0.27	CCMT 09 T3 08
	C4	20.0	47.0	3	C4-SCLCR/L-11070-09	40.0	16.0	70.0	11.0	10	3.0	0.36	CCMT 09 T3 08
	C4	25.0	57.0	3	C4-SCLCR/L-13080-09	40.0	20.0	80.0	13.0	10	3.0	0.41	CCMT 09 T3 08
	C4	32.0	68.0	3	C4-SCLCR/L-17090-09	40.0	25.0	90.0	17.0	10	3.0	0.51	CCMT 09 T3 08
	C4	50.0	60.0	3	C4-SCLCR/L-27080-09	40.0	40.0	80.0	27.0	10	3.0	0.69	CCMT 09 T3 08
	C5	20.0	46.0	3	C5-SCLCR/L-11070-09	50.0	16.0	70.0	11.0	10	3.0	0.57	CCMT 09 T3 08
	C5	25.0	56.0	3	C5-SCLCR/L-13080-09	50.0	20.0	80.0	13.0	10	3.0	0.65	CCMT 09 T3 08
	C5	32.0	67.0	3	C5-SCLCR/L-17090-09	50.0	25.0	90.0	17.0	10	3.0	0.69	CCMT 09 T3 08
12	C3	32.0	74.0	3	C3-SCLCR-17090-12	32.0	25.0	90.0	17.0	10	3.0	0.38	CCMT 12 04 08
	C3	40.0	81.0	3	C3-SCLCR-22096-12	32.0	32.0	96.0	22.0	10	3.0	0.54	CCMT 12 04 08
	C4	40.0	89.0	3	C4-SCLCR-22110-12	40.0	32.0	110.0	22.0	10	3.0	0.77	CCMT 12 04 08
	C5	40.0	88.0	3	C5-SCLCR/L-22110-12	50.0	32.0	110.0	22.0	10	3.0	0.97	CCMT 12 04 08
	C5	50.0	119.0	3	C5-SCLCR/L-27140-12	50.0	40.0	140.0	27.0	10	3.0	1.49	CCMT 12 04 08
C5	63.0	80.0	3	C5-SCLCR-35100-12	50.0	50.0	100.0	35.0	10	3.0	1.40	CCMT 12 04 08	

R = versão direita, L = versão esquerda

Código para pedido	Componentes		
	Parafuso	Calço	Parafuso do calço
C3-SCLCR/L-11065-09	5513 020-09		
C3-SCLCR/L-13075-09	5513 020-09		
C3-SCLCR/L-17090-09	5513 020-10		
C4-SCLCR/L-11070-09	5513 020-09		
C4-SCLCR/L-13080-09	5513 020-09		
C4-SCLCR/L-17090-09	5513 020-10		
C4-SCLCR/L-27080-09	5513 020-01	5322 232-01	5512 090-01
C5-SCLCR/L-11070-09	5513 020-09		
C5-SCLCR/L-13080-09	5513 020-09		
C5-SCLCR/L-17090-09	5513 020-10		
C3-SCLCR/L-17090-12	5513 020-17		
C3-SCLCR/L-22096-12	5513 020-18	5322 232-02	5512 090-03
C4-SCLCR/L-17090-12	5513 020-17		
C4-SCLCR/L-22110-12	5513 020-18	5322 232-02	5512 090-03
C4-SCLCR/L-27080-12	5513 020-18	5322 232-02	5512 090-03
C5-SCLCR/L-17090-12	5513 020-17		
C5-SCLCR/L-22110-12	5513 020-18	5322 232-02	5512 090-03
C5-SCLCR/L-27140-12	5513 020-18	5322 232-02	5512 090-03
C5-SCLCR-35100-12	5513 020-18	5322 232-02	5512 090-03

Para a lista completa de componentes, acesse www.sandvik.coromant.com



Unidade de corte CoroTurn® 107 para torneamento

Fixação por parafuso

Coromant Capto® - Refrigeração de precisão

KAPR

93.0°

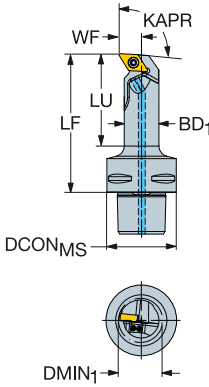

- DCMT, DCMX
DCGT, DCGX, DCET
- DCMW

C

D



							Dimensões, mm								
		CZC _{MS}	DMIN ₁	LU	RMPX	CNSC	Código para pedido	DCON _{MS}	BD	LF	WF	BAR	NM	KG	MIID
	07	C4	25.0	58.0	27°	3	C4-SDUCR-13080-07HP	40.0	20.0	80.0	13.0	150	0.9	0.41	DCMT 07 02 04
	11	C4	25.0	58.0	27°	3	C4-SDUCR/L-13080-11HP	40.0	20.0	80.0	13.0	150	3.0	0.41	DCMT 11 T3 08
		C4	32.0	69.0	27°	3	C4-SDUCR/L-17090-11HP	40.0	25.0	90.0	17.0	150	3.0	0.50	DCMT 11 T3 08
		C5	25.0	56.0	27°	3	C5-SDUCR/L-13080-11HP	50.0	20.0	80.0	13.0	150	3.0	0.60	DCMT 11 T3 08
		C5	32.0	67.0	27°	3	C5-SDUCR/L-17090-11HP	50.0	25.0	90.0	17.0	150	3.0	0.69	DCMT 11 T3 08

R = versão direita, L = versão esquerda

E

		Componentes	
	CZC _{MS}	Parafuso da pastilha	Olhal
07	C4	5513 020-03	5691 026-13
11	C4-C5	5513 020-10	5691 026-13

Para a lista completa de componentes, acesse www.sandvik.coromant.com

F

G

H



Unidade de corte CoroTurn® 107 para torneamento

Fixação por parafuso

Coromant Capto® - Refrigeração interna

KAPR

93.0°



- DCMT, DCMX
DCGT, DCGX, DCET
- DCMW

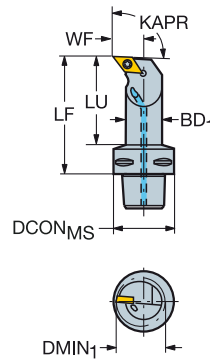

CZC _{MS}	DMIN ₁	LU	RMPX	CN5C	Código para pedido	Dimensões, mm						MIID		
						DCON _{MS}	BD	LF	WF	BAR	NM		KG	
07	C3	20.0	48.0	27°	3	C3-SDUCR/L-11065-07	32.0	16.0	65.0	11.0	10	0.9	0.21	DCMT 07 02 04
	C4	20.0	47.0	27°	3	C4-SDUCR/L-11070-07	40.0	16.0	70.0	11.0	10	0.9	0.36	DCMT 07 02 04
	C5	20.0	46.0	27°	3	C5-SDUCR/L-11070-07	50.0	16.0	70.0	11.0	10	0.9	0.55	DCMT 07 02 04
11	C3	25.0	58.0	27°	3	C3-SDUCR/L-13075-11	32.0	20.0	75.0	13.0	10	3.0	0.26	DCMT 11 T3 08
	C3	32.0	73.0	27°	3	C3-SDUCR/L-17090-11	32.0	25.0	90.0	17.0	10	3.0	0.38	DCMT 11 T3 08
	C4	25.0	57.0	27°	3	C4-SDUCR/L-13080-11	40.0	20.0	80.0	13.0	10	3.0	0.41	DCMT 11 T3 08
	C4	32.0	68.0	27°	3	C4-SDUCR/L-17090-11	40.0	25.0	90.0	17.0	10	3.0	0.52	DCMT 11 T3 08
	C4	40.0	89.0	27°	3	C4-SDUCR/L-22110-11	40.0	32.0	110.0	22.0	10	3.0	0.76	DCMT 11 T3 08
	C4	50.0	60.0	27°	3	C4-SDUCR/L-27080-11	40.0	40.0	80.0	27.0	10	3.0	0.72	DCMT 11 T3 08
	C5	25.0	56.0	27°	3	C5-SDUCR/L-13080-11	50.0	20.0	80.0	13.0	10	3.0	0.65	DCMT 11 T3 08
	C5	32.0	67.0	27°	3	C5-SDUCR/L-17090-11	50.0	25.0	90.0	17.0	10	3.0	0.70	DCMT 11 T3 08
	C5	40.0	88.0	27°	3	C5-SDUCR/L-22110-11	50.0	32.0	110.0	22.0	10	3.0	0.96	DCMT 11 T3 08
	C5	63.0	80.0	27°	3	C5-SDUCR/L-35100-11	50.0	50.0	100.0	35.0	10	3.0	1.35	DCMT 11 T3 08

R = versão direita, L = versão esquerda

Código para pedido	Componentes		
	Parafuso	Calço	Parafuso do calço
C3-SDUCR/L-11065-07	5513 020-03		
C4-SDUCR/L-11070-07	5513 020-03		
C5-SDUCR/L-11070-07	5513 020-03		
C3-SDUCR/L-13075-11	5513 020-09		
C3-SDUCR/L-17090-11	5513 020-10		
C4-SDUCR/L-13080-11	5513 020-09		
C4-SDUCR/L-17090-11	5513 020-10		
C4-SDUCR/L-22110-11	5513 020-01	5322 263-01	5512 090-01
C4-SDUCR/L-27080-11	5513 020-01	5322 263-01	5512 090-01
C5-SDUCR/L-13080-11	5513 020-09		
C5-SDUCR/L-17090-11	5513 020-10		
C5-SDUCR/L-22110-11	5513 020-01	5322 263-01	5512 090-01
C5-SDUCR/L-35100-11	5513 020-01	5322 263-01	5512 090-01

Para a lista completa de componentes, acesse www.sandvik.coromant.com



A

TORNEAMENTO GERAL

Ferramentas internas

Unidade de corte CoroTurn® 107 para torneamento

Fixação por parafuso

Coromant Capto® - Refrigeração interna

KAPR

75.0°

B

C

D

Código para pedido	Dimensões, mm											MIID		
	CZC _{MS}	DMIN ₁	LU	RMPX	CNSC	DCON _{MS}	BD	LPR	LF	WF	BAR		NM	KG
09	C4	25.0	58.0	10°	3	40.0	20.0	82.2	80.0	13.0	10	3.0	0.41	SCMT 09 T3 08
	C5	25.0	56.0	10°	3	50.0	20.0	82.2	80.0	13.0	10	3.0	0.61	SCMT 09 T3 08

R = versão direita

Componentes

Parafuso
5513 020-09Para a lista completa de componentes, acesse www.sandvik.coromant.com

F

G

H

A41

F2

E1

G1

ISO
13399

H36

H10

H5

A 94

Unidade de corte CoroTurn® 107 para torneamento

Fixação por parafuso

Coromant Capto® - Refrigeração de precisão

KAPR

91.0°



- TCMT, TCMX, TCGT, TCGX, TCEX
- TCMW

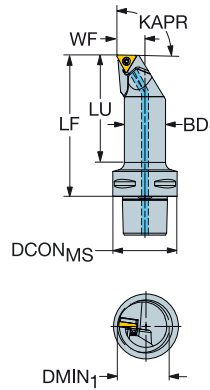

Código para pedido	CZC _{MS}	DMIN ₁	LU	CNSC	Código para pedido	Dimensões, mm							MIID
						DCON _{MS}	BD	LF	WF	BAR	NM	KG	
11	C4	20.0	47.0	3	C4-STFCR/L11070-11HPB1	40.0	16.0	70.0	11.0	150	0.9	0.36	TCMT 11 03 04
	C4	25.0	57.0	3	C4-STFCR/L13080-11HPB1	40.0	20.0	80.0	13.0	150	0.9	0.40	TCMT 11 03 04
16	C4	32.0	69.0	3	C4-STFCR/L-17090-16HP	40.0	25.0	90.0	17.0	150	3.0	0.51	TCMT 16 T3 08
	C5	32.0	67.0	3	C5-STFCR/L-17090-16HP	50.0	25.0	90.0	17.0	150	3.0	0.70	TCMT 16 T3 08
	C5	40.0	88.0	3	C5-STFCR-22110-16HP	50.0	32.0	110.0	22.0	150	3.0	0.96	TCMT 16 T3 08

B1 = Para pastilha com espessura de 03 = 3.18 mm.

R = versão direita, L = versão esquerda

Código para pedido	Componentes			
	Parafuso da pastilha	Calço	Parafuso do calço	Olhal
C4-STFCR/L11070-11HPB1	5513 020-03			5691 026-23
C4-STFCR/L13080-11HPB1	5513 020-03			5691 026-23
C4-STFCR/L-17090-16HP	5513 020-10			5691 026-23
C5-STFCR/L-17090-16HP	5513 020-10			5691 026-23
C5-STFCR/L-22110-16HP	5513 020-01	5322 320-01	5512 090-01	5691 026-23

Para a lista completa de componentes, acesse www.sandvik.coromant.com



Unidade de corte CoroTurn® 107 para torneamento

Fixação por parafuso

Coromant Capto® - Refrigeração interna

KAPR

91.0°



- TCMT, TCMX, TCGT, TCGX, TCEX
- TCMW

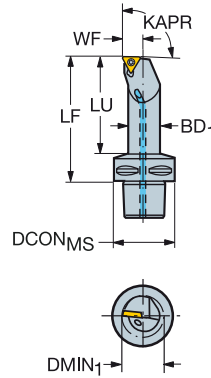

C

D

CZC _{MS}	DMIN ₁	LU	CNSC	Código para pedido	Dimensões, mm				Material			MIID	
					DCON _{MS}	BD	LF	WF	BAR	NM	KG		
11	C3	20.0	48.0	3	C3-STFCR/L-11065-11-B1	32.0	16.0	65.0	11.0	10	0.9	0.21	TCMT 11 03 04
	C4	20.0	47.0	3	C4-STFCR/L-11070-11	40.0	16.0	70.0	11.0	10	0.9	0.35	TCMT 11 02 04
	C4	25.0	57.0	3	C4-STFCR/L-13080-11	40.0	20.0	80.0	13.0	10	0.9	0.40	TCMT 11 02 04
	C4	20.0	47.0	3	C4-STFCR-11070-11-B1	40.0	16.0	70.0	11.0	10	0.9	0.35	TCMT 11 03 04
	C4	25.0	57.0	3	C4-STFCR-13080-11-B1	40.0	20.0	80.0	13.0	10	0.9	0.41	TCMT 11 03 04
	C5	20.0	46.0	3	C5-STFCR/L-11070-11-B1	50.0	16.0	70.0	11.0	10	0.9	0.55	TCMT 11 03 04
	C5	25.0	56.0	3	C5-STFCR/L-13080-11-B1	50.0	20.0	80.0	13.0	10	0.9	0.60	TCMT 11 03 04
16	C4	40.0	89.0	3	C4-STFCR/L-22110-16	40.0	32.0	110.0	22.0	10	3.0	0.77	TCMT 16 T3 08

B1 = Para pastilha com espessura de 03 = 3.18 mm.

R = versão direita, L = versão esquerda

E

Componentes			
Código para pedido	Parafuso	Calço	Parafuso do calço
C3-STFCR/L-11065-11-B1	5513 020-03		
C4-STFCR/L-11070-11	5513 020-03		
C4-STFCR/L-13080-11	5513 020-03		
C4-STFCR/L-11070-11-B1	5513 020-03		
C4-STFCR/L-13080-11-B1	5513 020-03		
C5-STFCR/L-11070-11-B1	5513 020-03		
C5-STFCR/L-13080-11-B1	5513 020-03		
C4-STFCR/L-22110-16	5513 020-01	5322 320-01	5512 090-01

Para a lista completa de componentes, acesse www.sandvik.coromant.com

F

G

H



Unidade de corte CoroTurn® 107 para torneamento

Fixação por parafuso

Coromant Capto® - Refrigeração de precisão

KAPR

107.5°



- VBMT, VBGT
VCGX, VCEX,
VCGT, VCE T
- VB MW, VCMW

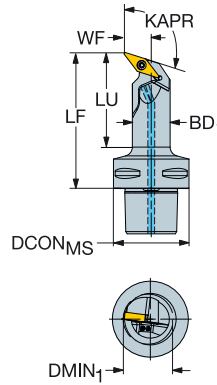

							Dimensões, mm								
	CZC _{MS}	DMIN ₁	LU	RMPX	CNSC	Código para pedido	DCON _{MS}	BD	LF	WF	BAR	NM	KG	MIID	
	11	C4	25.0	47.0	35°	3	C4-SVQBR/L13070-11HPB1	40.0	20.0	70.0	13.0	150	0.9	0.38	VBMT 11 03 04
	16	C4	33.0	68.0	35°	3	C4-SVQBR/L-18090-16HP	40.0	25.0	90.0	18.0	150	3.0	0.48	VBMT 16 04 08
		C5	33.0	67.0	35°	3	C5-SVQBR/L-18090-16HP	50.0	25.0	90.0	18.0	150	3.0	0.68	VBMT 16 04 08
		C6	40.0	94.0	35°	3	C6-SVQBR/L-22120-16HP	63.0	32.0	120.0	22.0	150	3.0	1.36	VBMT 16 04 08

B1 = Para pastilha com espessura de 03 = 3.18 mm.

R = versão direita, L = versão esquerda

Código para pedido	Componentes			
	Parafuso da pastilha	Calço	Parafuso do calço	Olhal
C4-SVQBR/L13070-11HPB1	5513 020-20			5691 026-13
C4-SVQBR/L-18090-16HP	5513 020-10			5691 026-13
C5-SVQBR/L-18090-16HP	5513 020-10			5691 026-13
C6-SVQBR/L-22120-16HP	5513 020-01	5322 270-01	5512 090-01	5691 026-13

Para a lista completa de componentes, acesse www.sandvik.coromant.com



Unidade de corte CoroTurn® 107 para torneamento

Fixação por parafuso

Coromant Capto® - Refrigeração interna

KAPR

107.5°



 VBMT, VBGT
VCGX, VCEX,
VCGT, VCET
 VBMW, VCMW

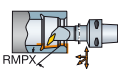
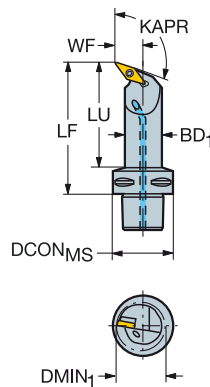

CZC _{MS}	DMIN ₁	LU	RMPX	CNCS	Código para pedido	Dimensões, mm						MIID		
						DCON _{MS}	BD	LF	WF	BAR	NM		KG	
11	C3	22.0	53.0	35°	3	C3-SVQBR/L-13070-11-B1	32.0	16.0	70.0	13.0	10	0.9	0.21	VBMT 11 03 04
	C4	27.0	57.0	35°	3	C4-SVQBR/L-15080-11-B1	40.0	20.0	80.0	15.0	10	0.9	0.40	VBMT 11 03 04
	C4	25.0	48.0	35°	3	C4-SVQBR/L-13070-11	40.0	20.0	70.0	13.0	10	0.9	0.38	VBMT 11 02 04
	C4	27.0	58.0	35°	3	C4-SVQBR/L-15080-11	40.0	20.0	80.0	15.0	10	0.9	0.40	VBMT 11 02 04
	C5	27.0	56.0	35°	3	C5-SVQBR/L-15080-11-B1	50.0	20.0	80.0	15.0	10	0.9	0.65	VBMT 11 03 04
16	C4	33.0	68.0	35°	3	C4-SVQBR/L-18090-16	40.0	25.0	90.0	18.0	10	3.0	0.50	VBMT 16 04 08
	C4	40.0	89.0	35°	3	C4-SVQBR/L-22110-16	40.0	32.0	110.0	22.0	10	3.0	0.73	VBMT 16 04 08
	C4	50.0	100.0	35°	3	C4-SVQBR/L-27120-16	40.0	40.0	120.0	27.0	10	3.0	0.99	VBMT 16 04 08
	C5	40.0	88.0	35°	3	C5-SVQBR/L-22110-16	50.0	32.0	110.0	22.0	10	3.0	0.93	VBMT 16 04 08
	C5	50.0	119.0	35°	3	C5-SVQBR/L-27140-16	50.0	40.0	140.0	27.0	10	3.0	1.38	VBMT 16 04 08
	C5	33.0	67.0	35°	3	C5-SVQBR/L-18090-16	50.0	25.0	90.0	18.0	10	3.0	0.68	VBMT 16 04 08
	C5	63.0	130.0	35°	3	C5-SVQBR/L-35150-16	50.0	50.0	150.0	35.0	10	3.0	1.90	VBMT 16 04 08
	C6	50.0	120.0	35°	3	C6-SVQBR/L-27145-16	63.0	40.0	145.0	27.0	10	3.0	1.76	VBMT 16 04 08
C6	63.0	151.0	35°	3	C6-SVQBR/L-35175-16	63.0	50.0	175.0	35.0	10	3.0	2.89	VBMT 16 04 08	

B1 = Para pastilha com espessura de 03 = 3.18 mm.

R = versão direita, L = versão esquerda

Código para pedido	Componentes		
	Parafuso	Calço	Parafuso do calço
C3-SVQBR/L-13070-11-B1	5513 020-20		
C4-SVQBR/L-13070-11-B1	5513 020-20		
C4-SVQBR/L-15080-11-B1	5513 020-20		
C4-SVQBR/L-13070-11	5513 020-03		
C4-SVQBR/L-15080-11	5513 020-03		
C5-SVQBR/L-15080-11-B1	5513 020-20		
C5-SVQBR/L-15080-11	5513 020-03		
C4-SVQBR/L-18090-16	5513 020-10		
C4-SVQBR/L-22110-16	5513 020-01	5322 270-02	5512 090-01
C4-SVQBR/L-27120-16	5513 020-01	5322 270-02	5512 090-01
C5-SVQBR/L-18090-16	5513 020-10		
C5-SVQBR/L-22110-16	5513 020-01	5322 270-02	5512 090-01
C5-SVQBR/L-27140-16	5513 020-01	5322 270-02	5512 090-01
C5-SVQBR/L-35100-16	5513 020-01	5322 270-02	5512 090-01
C5-SVQBR/L-35150-16	5513 020-01	5322 270-02	5512 090-01
C6-SVQBR/L-22120-16	5513 020-01	5322 270-02	5512 090-01
C6-SVQBR/L-27145-16	5513 020-01	5322 270-02	5512 090-01
C6-SVQBR/L-35175-16	5513 020-01	5322 270-02	5512 090-01

Para a lista completa de componentes, acesse www.sandvik.coromant.com



A41



F2



E1



G1



H36



H10



H5

Unidade de corte CoroTurn® 107 para mandrilamento reverso

Fixação por parafuso

Coromant Capto® - Refrigeração interna

KAPR

93.0°



- DCMT, DCMX
DCGT, DCGX, DCET
- DCMW

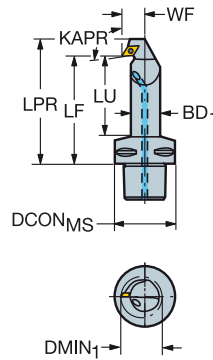

							Código para pedido	Dimensões, mm							MIID	
		CZC _{MS}	DMIN ₁	LU	RMPX	CNSC		DCON _{MS}	BD	LPR	LF	WF	BAR	NM		KG
	07	C4	22.0	47.3	27°	3	C4-SDUCR/L-13070-07X	40.0	16.0	81.5	70.0	13.0	10	0.9	0.37	DCMT 07 02 04
		C4	27.0	57.9	27°	3	C4-SDUCR/L-15080-07X	40.0	20.0	91.5	80.0	15.0	10	0.9	0.40	DCMT 07 02 04
		C4	32.0	68.5	27°	3	C4-SDUCR/L-18090-07X	40.0	25.0	101.5	90.0	18.0	10	0.9	0.54	DCMT 07 02 04
		C5	32.0	67.2	27°	3	C5-SDUCR/L-18090-07X	50.0	25.0	101.5	90.0	18.0	10	0.9	0.72	DCMT 07 02 04
		C5	27.0	56.5	27°	3	C5-SDUCR-15080-07X	50.0	20.0	91.5	80.0	15.0	10	0.9	0.60	DCMT 07 02 04

R = versão direita, L = versão esquerda

Componentes
Parafuso
5513 020-03

Para a lista completa de componentes, acesse www.sandvik.coromant.com



A

Barra de mandrilar CoroTurn® 107 para torneamento

Fixação por parafuso

Cilíndrica com ranhura para bucha EasyFix - Refrigeração de precisão

B



KAPR

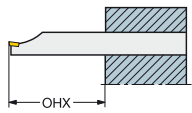

95.0°

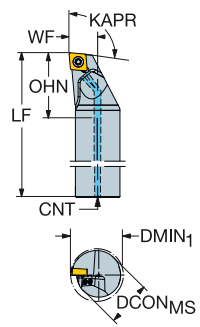

C

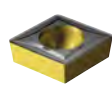

- CCMT, CCGT
CCGX, CCET
- CCMW

D

Código para pedido	Dimensões, mm										MIID		
	CZC _{MS}	DMIN ₁	OHX	OHN	CNSC	DCON _{MS}	BD	LF	WF	CNT		BAR	NM
A20S-SCLCR/L 09HP-R	20	25.0	80.0	33.8	1	20.0	20.0	250.0	13.0	G 1/8-28	275	3.0	0.58
A25T-SCLCR/L 09HP-R	25	32.0	100.0	32.8	1	25.0	25.0	300.0	17.0	G 1/8-28	275	3.0	1.02

R = versão direita, L = versão esquerda

E

Componentes			
CZC _{MS}	Parafuso da pastilha	Olhal	
09	20	5513 020-09	5691 026-13
09	25	5513 020-10	5691 026-13

Para a lista completa de componentes, acesse www.sandvik.coromant.com

F

G

H



Barra de mandrilar CoroTurn® 107 para torneamento

Fixação por parafuso

Cilíndrica com planos - Refrigeração de precisão

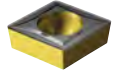

- CCMT, CCGT
- CCGX, CCET
- CCMW

KAPR

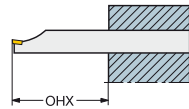

95.0°

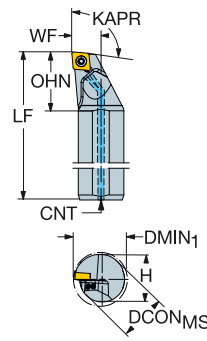

							Dimensões, mm												
	CZC _{MS}	DMIN ₁	OHX	OHN	CNSC	Código para pedido	DCON _{MS}	H	BD	LF	WF	CNT	BAR	NM	KG	MIID			
	09	20	25.0	80.0	33.0	1	A20S-SCLCR/L 09HP	20.0	18.0	20.0	250.0	13.0	G 1/8-28	275	3.0	0.55	CCMT 09 T3 08		
		25	32.0	100.0	32.0	1	A25T-SCLCR/L 09HP	25.0	23.0	25.0	300.0	17.0	G 1/8-28	275	3.0	0.95	CCMT 09 T3 08		

R = versão direita, L = versão esquerda

Componentes			
	CZC _{MS}	Parafuso da pastilha	Olhal
09	20	5513 020-09	5691 026-13
09	25	5513 020-10	5691 026-13

Para a lista completa de componentes, acesse www.sandvik.coromant.com



Barra de mandrilar CoroTurn® 107 para torneamento

Fixação por parafuso

Cilíndrica com canal para bucha EasyFix - Refrigeração interna

B



KAPR

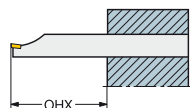

95.0°

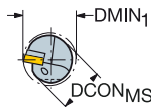
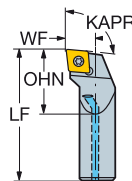

C

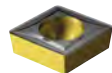

- CCMT, CCGT
CCGX, CCET
- CCMW

D

Código para pedido	Dimensões, mm						Código para pedido	Dimensões, mm						MIID
	CZC _{MS}	DMIN ₁	OHX	OHN	CNSC	DZC _{MS}		BD	LF	WF	BAR	NM	KG	
A08H-SCLCR/L 06-R	8	10.0	32.0	12.0	1	A08H-SCLCR/L 06-R	8.0	8.0	100.0	5.0	10	0.9	0.05	CCMT 06 02 04
A10K-SCLCR/L 06-R	10	12.0	40.0	15.0	1	A10K-SCLCR/L 06-R	10.0	10.0	125.0	6.0	10	0.9	0.08	CCMT 06 02 04
A12M-SCLCR/L 06-R	12	16.0	48.0	18.0	1	A12M-SCLCR/L 06-R	12.0	12.0	150.0	9.0	10	0.9	0.14	CCMT 06 02 04
A16R-SCLCR/L 06-R	16	20.0	64.0	24.0	1	A16R-SCLCR/L 06-R	16.0	16.0	200.0	11.0	10	0.9	0.26	CCMT 06 02 04
A16R-SCLCR/L 09-R	16	20.0	64.0	24.0	1	A16R-SCLCR/L 09-R	16.0	16.0	200.0	11.0	10	3.0	0.31	CCMT 09 T3 08
A20S-SCLCR/L 09-R	20	25.0	80.0	30.0	1	A20S-SCLCR/L 09-R	20.0	20.0	250.0	13.0	10	3.0	0.58	CCMT 09 T3 08

R = versão direita, L = versão esquerda

E

Componentes	
	Parafuso da pastilha
06	8-12
06	16
09	16-20

Para a lista completa de componentes, acesse www.sandvik.coromant.com

F

G

H



Barra de mandrilar CoroTurn® 107 para torneamento

Fixação por parafuso

Cilíndrica com planos - refrigeração interna

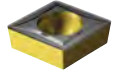

- CCMT, CCGT
CCGX, CCET
- CCMW

KAPR

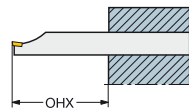

95.0°

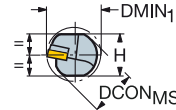
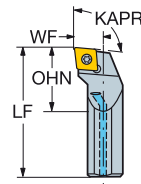

Código para pedido	Dimensões, mm											MIID	
	CZC _{MS}	DMIN ₁	OHX	OHN	CNSC	DCON _{MS}	H	BD	LF	WF	BAR		NM
06	8	10.0	32.0	12.0	1	8.0	7.0	8.0	100.0	5.0	10	0.9	0.05
	10	12.0	40.0	15.0	1	10.0	9.0	10.0	125.0	6.0	10	0.9	0.08
	12	16.0	48.0	18.0	1	12.0	11.0	12.0	150.0	9.0	10	0.9	0.13
	16	20.0	64.0	24.0	1	16.0	15.0	16.0	200.0	11.0	10	0.9	0.26
09	16	20.0	64.0	24.0	1	16.0	15.0	16.0	200.0	11.0	10	3.0	0.32
	20	25.0	80.0	30.0	1	20.0	18.0	20.0	250.0	13.0	10	3.0	0.40
	25	32.0	100.0	37.5	1	25.0	23.0	25.0	300.0	17.0	10	3.0	0.95
12	25	32.0	100.0	37.5	1	25.0	23.0	25.0	300.0	17.0	10	3.0	0.95
	32	40.0	128.0	48.0	1	32.0	30.0	32.0	300.0	22.0	10	3.0	1.67
40	50.0	160.0	60.0	1	40.0	37.0	40.0	300.0	27.0	10	3.0	2.52	

R = versão direita, L = versão esquerda

Componentes				
CZC _{MS}	Parafuso da pastilha	Calço	Parafuso do calço	
06	8-12	5513 020-46		
06	16	5513 020-03		
09	16-20	5513 020-09		
09	25	5513 020-10		
12	25	5513 020-17		
12	32-40	5513 020-18	5322 232-02	5512 090-03

Para a lista completa de componentes, acesse www.sandvik.coromant.com



Barra de mandrilar CoroTurn® 107 para torneamento

Fixação por parafuso

Cilíndrica com canal para bucha EasyFix - Refrigeração de precisão

B



KAPR

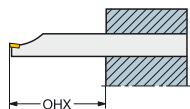

A..SDUCR/L..HP-R
93.0°

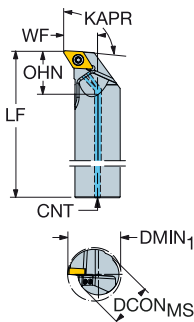

A..SDQCR/L..HP-R
107.5°

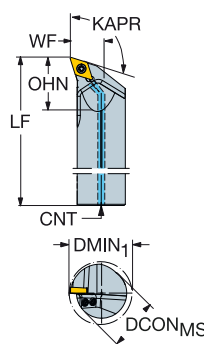

C



- DCMT, DCMX, DCGT, DCGX, DCET
- DCMW

D

		Dimensões, mm															
		CZC _{MS}	DMIN ₁	RMPX	OHX	OHN	CNSC	Código para pedido	DCON _{MS}	BD	LF	WF	CNT	BAR	NM	KG	MIID
	07	20	25.0	17°	80.0	22.2	1	A20S-SDQCR/L 07HP-R	20.0	20.0	250.0	13.0	G 1/8-28	275	0.9	0.56	DCMT 07 02 04
	11	25	32.0	17°	100.0	28.0	1	A25T-SDQCR/L 11HP-R	25.0	25.0	300.0	17.0	G 1/8-28	275	3.0	1.02	DCMT 11 T3 08
	07	20	25.0	27°	80.0	23.1	1	A20S-SDUCR 07HP-R	20.0	20.0	250.0	13.0	G 1/8-28	275	0.9	0.57	DCMT 07 02 04
	11	20	25.0	27°	80.0	22.3	1	A20S-SDUCR/L 11HP-R	20.0	20.0	250.0	13.0	G 1/8-28	275	3.0	0.58	DCMT 11 T3 08
	25	25	32.0	27°	100.0	28.7	1	A25T-SDUCR/L 11HP-R	25.0	25.0	300.0	17.0	G 1/8-28	275	3.0	1.03	DCMT 11 T3 08

R = versão direita, L = versão esquerda

E

		Componentes	
		Parafuso da pastilha	Olhal
	CZC _{MS}		
07	20	5513 020-03	5691 026-13
11	20	5513 020-09	5691 026-13
11	25	5513 020-10	5691 026-13

F

Para a lista completa de componentes, acesse www.sandvik.coromant.com

G

H



Barra de mandrilar CoroTurn® 107 para torneamento

Fixação por parafuso

Cilíndrica com planos - Refrigeração de precisão



- DCMT, DCMX, DCGT, DCGX, DCET
- DCMW

KAPR

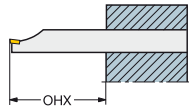

A..SDUCR/L...HP
93.0°

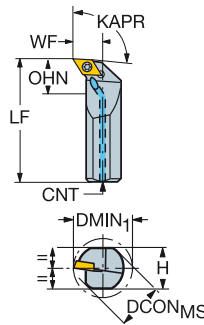

A..SDQCR/L...HP
107.5°

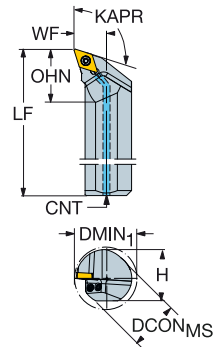

CZC _{MS}	DMIN ₁	RMPX	OHX	OHN	CNSC	Código para pedido	Dimensões, mm							MIID		
							DCON _{MS}	H	BD	LF	WF	CNT	BAR		NM	KG
07	20	25.0	17°	80.0	21.2	A20S-SDQCR/L 07HP	20.0	18.0	20.0	250.0	13.0	G 1/8-28	275	0.9	0.55	DCMT 07 02 04
11	25	32.0	17°	100.0	27.8	A25T-SDQCR/L 11HP	25.0	23.0	25.0	300.0	17.0	G 1/8-28	275	3.0	0.94	DCMT 11 T3 08
07	20	25.0	27°	80.0	22.2	A20S-SDUCR 07HP	20.0	18.0	20.0	250.0	13.0	G 1/8-28	275	0.9	0.55	DCMT 07 02 04
11	20	25.0	27°	80.0	22.0	A20S-SDUCR/L 11HP	20.0	18.0	20.0	250.0	13.0	G 1/8-28	275	3.0	0.55	DCMT 11 T3 08
11	25	32.0	27°	100.0	28.5	A25T-SDUCR/L 11HP	25.0	23.0	25.0	300.0	17.0	G 1/8-28	275	3.0	0.95	DCMT 11 T3 08

R = versão direita, L = versão esquerda

Componentes			
CZC _{MS}	Parafuso da pastilha	Olhal	
07	5513 020-03	5691 026-13	
11	5513 020-09	5691 026-13	
11	5513 020-10	5691 026-13	

Para a lista completa de componentes, acesse www.sandvik.coromant.com



Barra de mandrilar CoroTurn® 107 para torneamento

Fixação por parafuso

Cilíndrica com canal para bucha EasyFix - Refrigeração interna

B

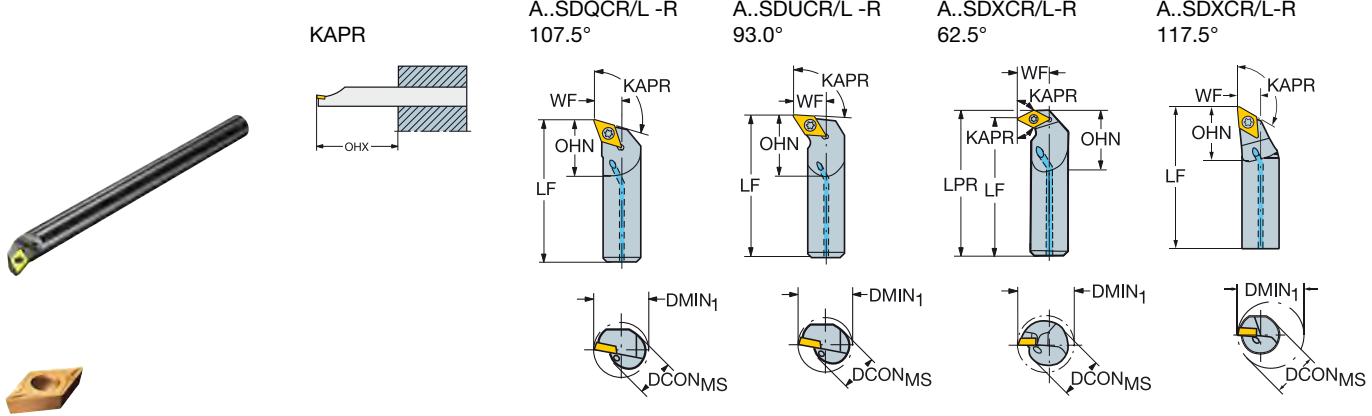

C



- DCMT, DCMX
DCGT, DCGX, DCET
- DCMW

D

CZC _{MS}	DMIN ₁	RMPX	OHX	OHN	CNSC	Código para pedido	Dimensões, mm						MIID			
							DCON _{MS}	LPR	LF	WF	BAR	NM		KG		
	07	10	13.0	17°	40.0	15.0	1	A10K-SDQCR/L 07-R	10	125.0	7.0	10	0.9	0.08	DCMT 07 02 04	
	12	16.0	17°	48.0	18.0	1	A12M-SDQCR/L 07-R	12	150.0	9.0	10	0.9	0.13	DCMT 07 02 04		
	16	20.0	17°	64.0	24.0	1	A16R-SDQCR/L 07-R	16	200.0	11.0	10	0.9	0.31	DCMT 07 02 04		
	11	20	25.0	17°	80.0	30.0	1	A20S-SDQCR/L 11-R	20	250.0	13.0	10	3.0	0.58	DCMT 11 T3 08	
	07	10	15.0	27°	40.0	15.0	1	A10K-SDUCR/L 07-ER	10	125.0	9.0	10	0.9	0.08	DCMT 07 02 04	
	12	18.0	27°	48.0	18.0	1	A12M-SDUCR/L 07-ER	12	150.0	11.0	10	0.9	0.13	DCMT 07 02 04		
	16	20.0	27°	64.0	24.0	1	A16R-SDUCR/L 07-R	16	200.0	11.0	10	0.9	0.31	DCMT 07 02 04		
	11	20	25.0	27°	80.0	30.0	1	A20S-SDUCR/L 11-R	20	250.0	13.0	10	3.0	0.59	DCMT 11 T3 08	
	07	12	16.0	60°	48.0	18.0	1	A12M-SDXCR/L 07-R	12	155.1	150.0	9.0	10	0.9	0.13	DCMT 07 02 04
	16	20.0	60°	64.0	24.0	1	A16R-SDXCR/L 07-R	16	205.1	200.0	11.0	10	0.9	0.30	DCMT 07 02 04	
	11	20	25.0	60°	80.0	30.0	1	A20S-SDXCR/L 11-R	20	256.8	250.0	13.0	10	3.0	0.59	DCMT 11 T3 08
	07	16	20.0	5°	64.0	24.0	1	A16K-SDXCR/L 07-R	16	125.0	9.0	10	0.9	0.17	DCMT 07 02 04	
	11	20	25.0	3°	80.0	30.0	1	A20M-SDXCR/L 11-R	20	150.0	12.0	10	3.0	0.33	DCMT 11 T3 08	

R = versão direita, L = versão esquerda

F

Componentes		
	CZC _{MS}	Parafuso da pastilha
07	10-16	5513 020-03
11	20	5513 020-09

G

Para a lista completa de componentes, acesse www.sandvik.coromant.com

H



Barra de mandrilar CoroTurn® 107 para torneamento

Fixação por parafuso

Cilíndrica com planos - refrigeração interna



KAPR

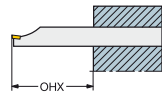

A..SDQCR/L
107.5°

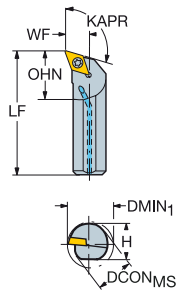

A..SDUCR/L
93.0°

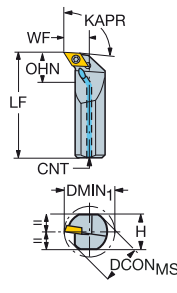

A..SDXCR/L
62.5°

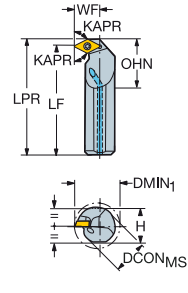

- DCMT, DCMX
DCGT, DCGX, DCET
- DCMW

	CZC _{MS}	DMIN ₁	RMPX	OHX	OHN	CNSC	Código para pedido	Dimensões, mm							MIID		
								DCON _{MS}	H	BD	LPR	LF	WF	BAR		NM	KG
	07	10	13.0	17°	40.0	15.0	A10K-SDQCR/L 07	10.0	9.0	10.0	125.0	7.0	10	0.9	0.08	DCMT 07 02 04	
		12	16.0	17°	48.0	18.0	A12M-SDQCR/L 07	12.0	11.0	12.0	150.0	9.0	10	0.9	0.13	DCMT 07 02 04	
		16	20.0	17°	64.0	24.0	A16R-SDQCR/L 07	16.0	15.0	16.0	200.0	11.0	10	0.9	0.28	DCMT 07 02 04	
	11	20	25.0	17°	80.0	30.0	A20S-SDQCR/L 11	20.0	18.0	20.0	250.0	13.0	10	3.0	0.56	DCMT 11 T3 08	
		25	32.0	17°	100.0	37.5	A25T-SDQCR/L 11	25.0	23.0	25.0	300.0	17.0	10	3.0	0.94	DCMT 11 T3 08	
	07	10	13.0	27°	40.0	15.0	A10K-SDUCR/L 07	10.0	9.0	10.0	125.0	7.0	10	0.9	0.08	DCMT 07 02 04	
		12	16.0	27°	48.0	18.0	A12M-SDUCR/L 07	12.0	11.0	12.0	150.0	9.0	10	0.9	0.13	DCMT 07 02 04	
		16	20.0	27°	64.0	24.0	A16R-SDUCR/L 07	16.0	15.0	16.0	200.0	11.0	10	0.9	0.31	DCMT 07 02 04	
	11	20	25.0	27°	80.0	30.0	A20S-SDUCR/L 11	20.0	18.0	20.0	250.0	13.0	10	3.0	0.46	DCMT 11 T3 08	
		25	32.0	27°	100.0	37.5	A25T-SDUCR/L 11	25.0	23.0	25.0	300.0	17.0	10	3.0	0.95	DCMT 11 T3 08	
	07	12	16.0	60°	48.0	18.0	A12M-SDXCR/L 07	12.0	11.0	12.0	155.1	150.0	9.0	10	0.9	0.13	DCMT 07 02 04
		16	20.0	60°	64.0	24.0	A16R-SDXCR/L 07	16.0	15.0	16.0	205.1	200.0	11.0	10	0.9	0.29	DCMT 07 02 04
		20	25.0	60°	80.0	30.0	A20S-SDXCR/L 11	20.0	18.0	20.0	256.8	250.0	13.0	10	3.0	0.56	DCMT 11 T3 08
	11	25	32.0	60°	100.0	37.5	A25T-SDXCR/L 11	25.0	23.0	25.0	306.8	300.0	17.0	10	3.0	0.96	DCMT 11 T3 08

R = versão direita, L = versão esquerda

Componentes		
	CZC _{MS}	Parafuso da pastilha
07	10	5513 020-48
07	12-16	5513 020-03
11	20	5513 020-09
11	25	5513 020-10

Para a lista completa de componentes, acesse www.sandvik.coromant.com



A

TORNEAMENTO GERAL

Ferramentas internas

Barra de mandrilar CoroTurn® 107 para torneamento

Fixação por parafuso

Cilíndrica com canal para bucha EasyFix - Refrigeração interna

B

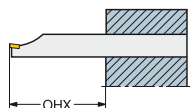
A..SRXDR/L-R

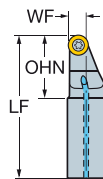

A..SRDDN-R

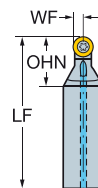

C

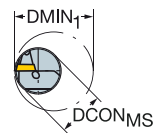
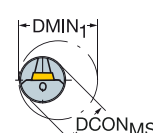

R300

D

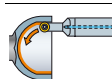

										Dimensões, mm								
	08	16	20.0	12.6	90°	64.0	24.0	1	Código para pedido	DCON _{MS}	BD	LF	WF	BAR	NM	KG	MIID	
									A16K-SRDDN 08-R	16.0	16.0	125.0	4.0	10	0.9	0.17	R300-0828..	
	08	20	25.0		0°	80.0	30.0	1	A20M-SRXDR/L 08-R	20.0	20.0	150.0	9.0	10	1.2	0.34	R300-0828..	
	10	20	25.0		0°	80.0	30.0	1	A20M-SRXDR/L 10-R	20.0	20.0	150.0	9.0	10	3.0	0.30	R300-1032..	

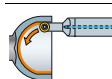
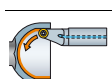
E

Para pastilhas e dados de corte, consulte o catálogo de Ferramentas rotativas

N = neutra, R = versão direita, L = versão esquerda

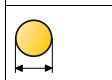
		Componentes
	CZC _{MS}	Parafuso da pastilha
08	16	5513 020-48
08	20	5513 020-56
10	20	5513 020-43

F

Para a lista completa de componentes, acesse www.sandvik.coromant.com

G

H



A41



F2



G1



H36

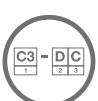

H10



H5

A 108



Barra de mandrilar CoroTurn® 107 para torneamento

Fixação por parafuso

Cilíndrica com canal para bucha EasyFix - Refrigeração interna



SCMT, SCGX
SCMW

KAPR

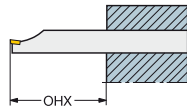

75.0°

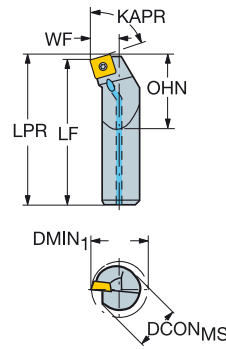

Código para pedido	Dimensões, mm							Código para pedido	Dimensões, mm							MIID
	CZC _{MS}	DMIN ₁	RMPX	OHX	OHN	CNSC	DCON _{MS}		BD	LPR	LF	WF	BAR	NM	KG	
09	16	20.0	10°	64.0	24.0	1	A16R-SSKCR 09-R	16.0	16.0	202.2	200.0	11.0	10	3.0	0.31	SCMT 09 T3 08
	20	25.0	10°	80.0	30.0	1	A20S-SSKCR 09-R	20.0	20.0	252.2	250.0	13.0	10	3.0	0.59	SCMT 09 T3 08

R = versão direita

Componentes
Parafuso da pastilha
5513 020-09

Para a lista completa de componentes, acesse www.sandvik.coromant.com



A

Barra de mandrilar CoroTurn® 107 para torneamento

Fixação por parafuso

Cilíndrica com planos - Refrigeração interna

B



KAPR

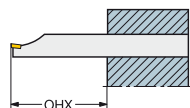

75.0°

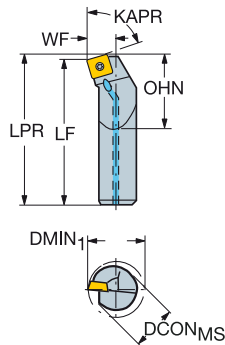

C



- SCMT, SCGX
- SCMW

D

CZC _{MS}	DMIN ₁	RMPX	OHX	OHN	CNSC	Código para pedido	Dimensões, mm						BAR	NM	KG	MIID	
							DCON _{MS}	H	BD	LPR	LF	WF					
09	16	20.0	10°	64.0	24.0	1	A16R-SSKCR/L 09	16.0	15.0	16.0	202.2	200.0	11.0	10	3.0	0.31	SCMT 09 T3 08
	20	25.0	10°	80.0	30.0	1	A20S-SSKCR/L 09	20.0	18.0	20.0	252.2	250.0	13.0	10	3.0	0.56	SCMT 09 T3 08
12	25	32.0	10°	100.0	37.5	1	A25T-SSKCR/L 12	25.0	23.0	25.0	303.1	300.0	17.0	10	3.0	0.86	SCMT 12 04 08
	32	40.0	10°	128.0	48.0	1	A32T-SSKCR 12	32.0	30.0	32.0	303.1	300.0	22.0	10	3.0	1.68	SCMT 12 04 08

R = versão direita, L = versão esquerda

E

Componentes				
CZC _{MS}	Parafuso da pastilha	Calço	Parafuso do calço	
09	16-20	5513 020-09		
12	25	5513 020-17		
12	32	5513 020-18	5322 420-02	5512 090-03

Para a lista completa de componentes, acesse www.sandvik.coromant.com

F

G

H



FOR

Barra de mandrilar CoroTurn® 107 para torneamento

Fixação por parafuso

Cilíndrica com ranhura para bucha EasyFix - Refrigeração de precisão



- TCMT, TCMX, TCGT, TCGX, TCEX
- TCMW

KAPR

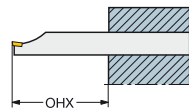

91.0°

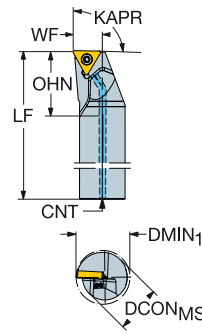

		Dimensões, mm					Código para pedido	Dimensões, mm						MIID	
		CZC _{MS}	DMIN ₁	OHX	OHN	CNSC		DCON _{MS}	BD	LF	WF	CNT	BAR		NM
11	20	25.0	80.0	27.1	1	A20S-STFCR/L 11HP-RB1	20.0	20.0	250.0	13.0	G 1/8-28	275	0.9	0.57	TCMT 11 03 04
16	25	32.0	100.0	31.5	1	A25T-STFCR/L 16HP-R	25.0	25.0	300.0	17.0	G 1/8-28	275	3.0	1.04	TCMT 16 T3 08

B1 = Para pastilha com espessura de 03 = 3.18 mm.

R = versão direita, L = versão esquerda

Componentes			
	CZC _{MS}	Parafuso da pastilha	Olhal
11	20	5513 020-03	5691 026-23
16	25	5513 020-10	5691 026-23

Para a lista completa de componentes, acesse www.sandvik.coromant.com



Barra de mandrilar CoroTurn® 107 para torneamento

Fixação por parafuso

Cilíndrica com planos - Refrigeração de precisão

B



KAPR

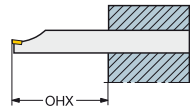

91.0°

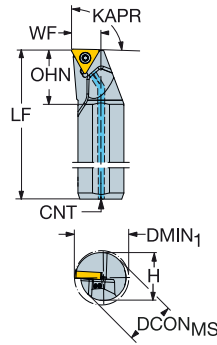

C



- TCMT, TCMX, TCGT, TCGX, TCEX
- TCMW

D

		Dimensões, mm																
		CZC _{MS}	DMIN ₁	OHX	OHN	CNSC	Código para pedido	DCON _{MS}	H	BD	LF	WF	CNT	BAR	NM	KG	MIID	
		16	25	32.0	100.0	31.2	1	A25T-STFCR/L 16HP	25.0	23.0	25.0	300.0	17.0	G 1/8-28	275	3.0	0.96	TCMT 16 T3 08

R = versão direita, L = versão esquerda

Componentes	
Parafuso da pastilha	Olhal
5513 020-10	5691 026-23

Para a lista completa de componentes, acesse www.sandvik.coromant.com

F

G

H



Barra de mandrilar CoroTurn® 107 para torneamento

Fixação por parafuso

Cilíndrica com canal para bucha EasyFix - Refrigeração interna



- TCMT, TCMX, TCGT, TCGX, TCEX
- TCMW

KAPR

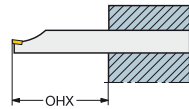

91.0°

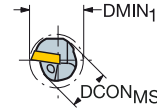
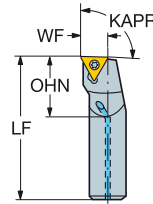

Código para pedido	Dimensões, mm										MIID	
	CZC _{MS}	DMIN ₁	OHX	OHN	CNSC	DCON _{MS}	BD	LF	WF	BAR		NM
A06F-STFCR/L 06-R	6	8.5	24.0	9.0	1	6.0	6.0	80.0	4.5	10	0.6	0.03
A08H-STFCR/L 06-R	8	11.0	32.0	12.0	1	8.0	8.0	100.0	5.9	10	0.6	0.05
A10K-STFCR/L 09-R	10	13.0	40.0	15.0	1	10.0	10.0	125.0	7.0	10	0.9	0.08
A12M-STFCR/L 09-R	12	16.0	48.0	18.0	1	12.0	12.0	150.0	9.0	10	0.9	0.12
A12M-STFCR/L 11-RB1	12	16.0	48.0	18.0	1	12.0	12.0	150.0	9.0	10	0.9	0.13
A16R-STFCR/L 11-RB1	16	20.0	64.0	24.0	1	16.0	16.0	200.0	11.0	10	0.9	0.30
A20S-STFCR/L 11-RB1	20	25.0	80.0	30.0	1	20.0	20.0	250.0	13.0	10	0.9	0.57
A25T-STFCR 11-RB1	25	32.0	100.0	37.5	1	25.0	25.0	300.0	17.0	10	0.9	1.02

B1 = Para pastilha com espessura de 03 = 3.18 mm.

R = versão direita, L = versão esquerda

Componentes	
	Parafuso da pastilha
CZC _{MS}	
06	6
06	8
09	10-12
11	12-25

Para a lista completa de componentes, acesse www.sandvik.coromant.com



A

Barra de mandrilar CoroTurn® 107 para torneamento

Fixação por parafuso

Cilíndrica com canal para bucha EasyFix - Refrigeração interna

B



KAPR

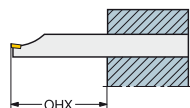

93.0°

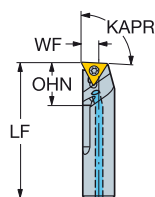

C



TCEX

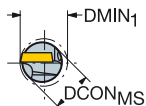

D

CZC _{MS}	DMIN ₁	OHX	OHN	CNSC	Código para pedido	Dimensões, mm						MIID		
						DCON _{MS}	BD	LF	WF	BAR	NM		KG	
05	5	6.0	20.0	7.5	1	A05F-STUCR/L 05-GR	5.0	5.0	80.0	2.9	10	0.4	0.02	TCEX 05 01 00R-F
						A06F-STUCR/L 05-GR	6.0	6.0	80.0	3.2	10	0.4	0.03	TCEX 05 01 00R-F
06	8	9.0	32.0	12.0	1	A08H-STUCR/L 06-GR	8.0	8.0	100.0	4.2	10	0.6	0.05	TCEX 06 T1 00R-F
						A10K-STUCR/L 06-GR	10.0	10.0	125.0	5.2	10	0.6	0.08	TCEX 06 T1 00R-F

A barra de mandrilar versão direita (R) usa pastilhas TCEX versão esquerda (L) e vice-versa.

R = versão direita, L = versão esquerda

E

Componentes	
CZC _{MS}	Parafuso da pastilha
05	5-6
06	8
06	10

Para a lista completa de componentes, acesse www.sandvik.coromant.com

F

G

H



FOR

Barra de mandrilar CoroTurn® 107 para torneamento

Fixação por parafuso

Cilíndrica com planos - Refrigeração interna



- TCMT, TCMX, TCGT, TCGX, TCEX
- TCMW

KAPR

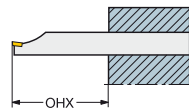

91.0°

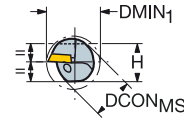
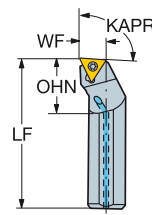

Código para pedido	Dimensões, mm											MIID		
	CZC _{MS}	DMIN ₁	OHX	OHN	CNSC	DCON _{MS}	H	BD	LF	WF	BAR		NM	KG
A06F-STFCR/L 06	6	8.5	24.0	9.0	1	6.0	5.0	6.0	80.0	4.5	10	0.6	0.03	
	8	11.0	32.0	12.0	1	8.0	7.0	8.0	100.0	5.9	10	0.6	0.05	
A10K-STFCR/L 09	10	13.0	40.0	15.0	1	10.0	9.0	10.0	125.0	7.0	10	0.9	0.08	
	12	16.0	48.0	18.0	1	12.0	11.0	12.0	150.0	9.0	10	0.9	0.13	
A12M-STFCR/L 11	12	16.0	48.0	18.0	1	12.0	11.0	12.0	150.0	9.0	10	0.9	0.13	
	12	16.0	48.0	18.0	1	12.0	11.0	12.0	150.0	9.0	10	0.9	0.13	
A16R-STFCR/L 11	16	20.0	64.0	24.0	1	16.0	15.0	16.0	200.0	11.0	10	0.9	0.28	
A16R-STFCR/L 11-B1	16	20.0	64.0	24.0	1	16.0	15.0	16.0	200.0	11.0	10	0.9	0.29	
A20S-STFCR/L 11	20	25.0	80.0	30.0	1	20.0	18.0	20.0	250.0	13.0	10	0.9	0.53	
A20S-STFCR/L 11-B1	20	25.0	80.0	30.0	1	20.0	18.0	20.0	250.0	13.0	10	0.9	0.53	
A25T-STFCR/L 16	16	25	32.0	100.0	37.5	1	25.0	23.0	25.0	300.0	17.0	10	3.0	0.88
A32T-STFCR/L 16	32	40.0	128.0	48.0	1	32.0	30.0	32.0	300.0	22.0	10	3.0	1.67	
A40T-STFCR/L 16	40	50.0	160.0	60.0	1	40.0	37.0	40.0	300.0	27.0	10	3.0	2.44	

B1 = Para pastilha com espessura de 03 = 3.18 mm.

R = versão direita, L = versão esquerda

Componentes				
Código para pedido	CZC _{MS}	Parafuso da pastilha	Calço	Parafuso do calço
A06F-STFCR/L 06	6	5513 020-28		
A08H-STFCR/L 06	8	5513 020-27		
A10K-STFCR/L 09	10-12	5513 020-05		
A12M-STFCR/L 11	12-20	5513 020-03		
A16R-STFCR/L 11	25	5513 020-10		
A16R-STFCR/L 11-B1	32-40	5513 020-01	5322 320-01	5512 090-01

Para a lista completa de componentes, acesse www.sandvik.coromant.com



A TORNEAMENTO GERAL

Ferramentas internas

Barra de mandrilar CoroTurn® 107 para torneamento

Fixação por parafuso

Cilíndrica com ranhura para bucha EasyFix - Refrigeração de precisão

B

A..SVPBR/L...HP-R
117.5°

A..SVUBR/L...HP-DR
93.0°

C

- VBMT, VBGT, VCGX, VCEX, VCGT, VCET
- VBMW, VCMW

D

										Dimensões, mm									
		CZC _{MS}	DMIN ₁	RMPX	OHX	OHN	CNSC	Código para pedido	DCON _{MS}	BD	LF	WF	CNT	BAR	NM	KG	MIID		
	16	25	32.0	30°	100.0	31.4	1	A25T-SVPBR/L 16HP-R	25.0	25.0	300.0	17.0	G 1/8-28	275	3.0	1.02	VBMT 16 04 08		
	16	25	33.0	50°	100.0	32.5	1	A25T-SVUBR/L 16HP-DR	25.0	25.0	300.0	18.0	G 1/8-28	275	3.0	1.04	VBMT 16 04 08		

E B1 = Para pastilha com espessura de 03 = 3.18 mm.

R = versão direita, L = versão esquerda

Componentes	
Parafuso da pastilha	Olhal
5513 020-10	5691 026-13

Para a lista completa de componentes, acesse www.sandvik.coromant.com

F

G

H

A 116

Barra de mandrilar CoroTurn® 107 para torneamento

Fixação por parafuso

Cilíndrica com planos - Refrigeração de precisão

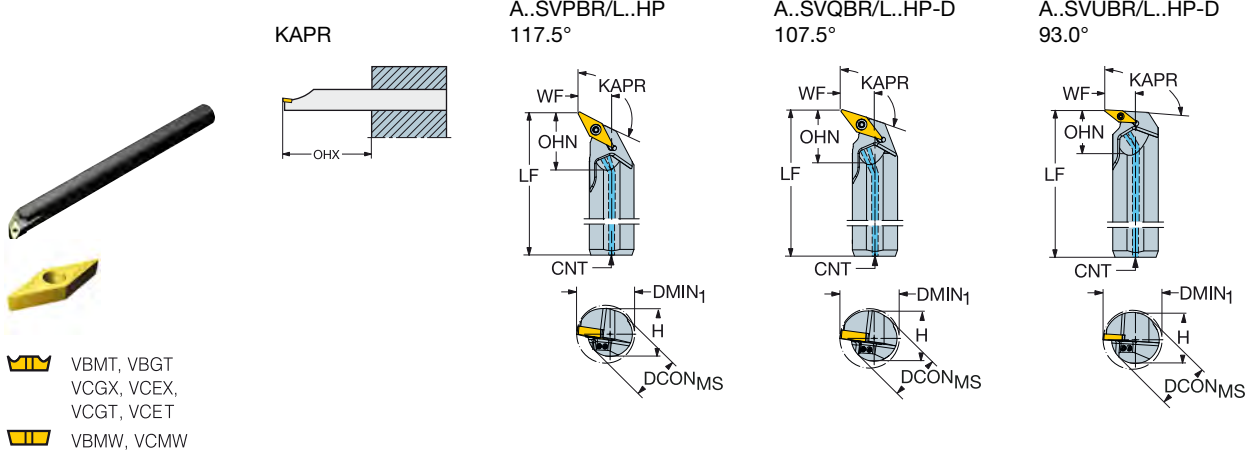

		Dimensões, mm																
		CZC _{MS}	DMIN ₁	RMPX	OHX	OHN	CNSC	Código para pedido	DCON _{MS}	H	BD	LF	WF	CNT	BAR	NM	KG	MIID
	16	25	32.0	30°	100.0	31.0	1	A25T-SVPBR/L 16HP	25.0	23.0	25.0	300.0	17.0	G 1/8-28	275	3.0	0.94	VBMT 16 04 08
	16	25	33.0	35°	100.0	32.8	1	A25T-SVQBR/L 16HP-D	25.0	23.0	25.0	300.0	18.0	G 1/8-28	275	3.0	0.95	VBMT 16 04 08
	11	25	33.0	50°	100.0	26.7	1	A25T-SVUBR 11HP-DB1	25.0	23.0	25.0	300.0	18.0	G 1/8-28	275	0.9	0.96	VBMT 11 03 04
	16	25	33.0	50°	100.0	33.0	1	A25T-SVUBR/L 16HP-D	25.0	23.0	25.0	300.0	18.0	G 1/8-28	275	3.0	0.96	VBMT 16 04 08

B1 = Para pastilha com espessura de 03 = 3.18 mm.

R = versão direita, L = versão esquerda

Componentes			
	CZC _{MS}	Parafuso da pastilha	Olhal
	11	25	5513 020-20 / 5691 026-13
	16	25	5513 020-10 / 5691 026-13

Para a lista completa de componentes, acesse www.sandvik.coromant.com



Barra de mandrilar CoroTurn® 107 para torneamento

Fixação por parafuso

Cilíndrica com canal para bucha EasyFix - Refrigeração interna

B



KAPR

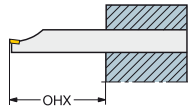

A..SVUCR/L -ER
93.0°

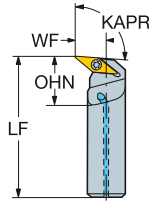

A..SVQCR/L-ER
107.5°

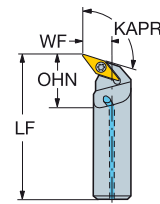

C



- VCMT, VCEX, VCGX
- VCMW

D



		Dimensões, mm														
		CZC _{MS}	DMIN ₁	RMPX	OHX	OHN	CNSC	Código para pedido	DCON _{MS}	BD	LF	WF	BAR	NM	KG	MIID
	11	16	22.0	35°	64.0	24.0	1	A16R-SVQCR/L 11-ER	16.0	16.0	200.0	13.0	10	0.9	0.30	VCMT 11 03 04
	11	16	22.0	50°	64.0	24.0	1	A16R-SVUCR/L 11-ER	16.0	16.0	200.0	13.0	10	0.9	0.30	VCMT 11 03 04

R = versão direita, L = versão esquerda

Componentes

Parafuso da pastilha
5513 020-03

Para a lista completa de componentes, acesse www.sandvik.coromant.com

F

G

H



Barra de mandrilar CoroTurn® 107 para torneamento

Fixação por parafuso

Cilíndrica com canal para bucha EasyFix - Refrigeração interna



VBMT, VBGT
VCGX, VCEX,
VCGT, VCET

VBMT, VCMW

KAPR

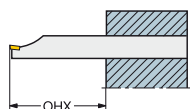

A..SVUBR/L -ER
93.0°

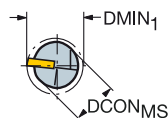
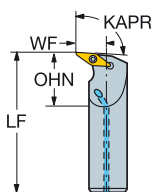

A..SVQBR/L -R
107.5°

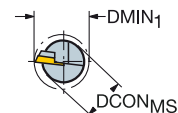
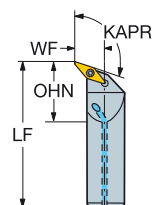

								Código para pedido	Dimensões, mm						MIID	
		CZC _{MS}	DMIN ₁	RMPX	OHX	OHN	CNSC		DCON _{MS}	BD	LF	WF	BAR	NM		KG
	11	20	27.0	35°	80.0	30.0	1	A20S-SVQBR/L 11-ERB1	20.0	20.0	250.0	15.0	10	0.9	0.58	VBMT 11 03 04
	11	16	22.0	50°	64.0	24.0	1	A16R-SVUBR/L 11-ERB1	16.0	16.0	200.0	13.0	10	0.9	0.30	VBMT 11 03 04
		20	27.0	50°	80.0	30.0	1	A20S-SVUBR/L 11-ERB1	20.0	20.0	250.0	15.0	10	0.9	0.58	VBMT 11 03 04

B1 = Para pastilha com espessura de 03 = 3.18 mm.

R = versão direita, L = versão esquerda

Componentes
Parafuso da pastilha
5513 020-20

Para a lista completa de componentes, acesse www.sandvik.coromant.com



A

Barra de mandrilar CoroTurn® 107 para torneamento

Fixação por parafuso

Cilíndrica com planos - Refrigeração interna

B

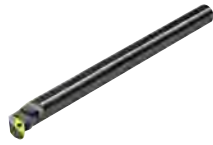

KAPR

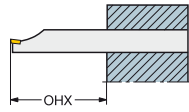

A..SVUCR/L
93.0°

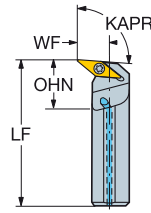

A..SVQCR/L
107.5°

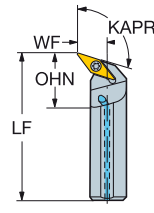

C

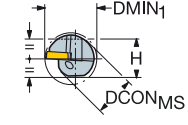
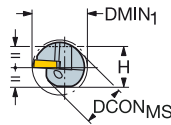

- VCMT, VCEX, VCGX
- VCMW

D

								Dimensões, mm										MIID
		CZC _{MS}	DMIN ₁	RMPX	OHX	OHN	CNSC	Código para pedido	DCON _{MS}	H	BD	LF	WF	BAR	NM	KG		
	11	16	22.0	35°	64.0	24.0	1	A16R-SVQCR/L 11-E	16.0	15.0	16.0	200.0	13.0	10	0.9	0.28	VCMT 11 03 04	
	11	16	22.0	50°	64.0	24.0	1	A16R-SVUCR/L 11-E	16.0	15.0	16.0	200.0	13.0	10	0.9	0.29	VCMT 11 03 04	

R = versão direita, L = versão esquerda

E

Componentes
Parafuso da pastilha
5513 020-03

Para a lista completa de componentes, acesse www.sandvik.coromant.com

F

G

H



Barra de mandrilar CoroTurn® 107 para torneamento

Fixação por parafuso

Cilíndrica com planos - Refrigeração interna



- VBMT, VBG, VCGX, VCEX, VCGT, VCE
- VBMT, VCMW

KAPR

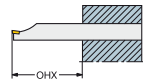

A..SVPBR/L
117.5°

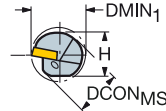
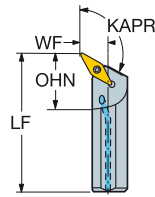

A..SVQBR/L
107.5°

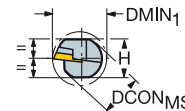
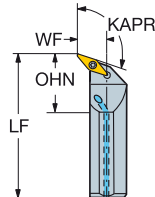

A..SVUBR/L
93.0°

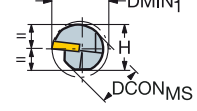
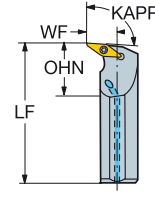

	CZC _{MS}	DMIN ₁	RMPX	OHX	OHN	CNSC	Código para pedido	Dimensões, mm							MIID	
								DCON _{MS}	H	BD	LF	WF	BAR	NM		KG
	16	25	32.0	25°	100.0	37.5	A25T-SVPBR/L 16	25.0	23.0	25.0	300.0	17.0	10	3.0	0.94	VBMT 16 04 08
		32	40.0	25°	128.0	48.0	A32T-SVPBR/L 16	32.0	30.0	32.0	300.0	22.0	10	3.0	1.65	VBMT 16 04 08
		40	50.0	25°	160.0	60.0	A40T-SVPBR/L 16	40.0	37.0	40.0	300.0	27.0	10	3.0	2.45	VBMT 16 04 08
	11	16	22.0	35°	64.0	24.0	A16R-SVQBR/L 11-E	16.0	15.0	16.0	200.0	13.0	10	0.9	0.28	VBMT 11 02 04
		16	22.0	35°	64.0	24.0	A16R-SVQBR/L 11-EB1	16.0	15.0	16.0	200.0	13.0	10	0.9	0.30	VBMT 11 03 04
		20	27.0	35°	80.0	30.0	A20S-SVQBR/L 11-E	20.0	18.0	20.0	250.0	15.0	10	0.9	0.54	VBMT 11 02 04
		20	27.0	35°	80.0	30.0	A20S-SVQBR/L 11-EB1	20.0	18.0	20.0	250.0	15.0	10	0.9	0.54	VBMT 11 03 04
		25	33.0	35°	100.0	37.5	A25T-SVQBR/L 11-D	25.0	23.0	25.0	300.0	18.0	10	0.9	0.95	VBMT 11 02 04
	25	33.0	35°	100.0	37.5	A25T-SVQBR/L 11-DB1	25.0	23.0	25.0	300.0	18.0	10	0.9	0.94	VBMT 11 03 04	
	16	25	33.0	35°	100.0	37.5	A25T-SVQBR/L 16-D	25.0	23.0	25.0	300.0	18.0	10	3.0	0.95	VBMT 16 04 08
		32	40.0	35°	128.0	48.0	A32T-SVQBR/L 16	32.0	30.0	32.0	300.0	22.0	10	3.0	1.66	VBMT 16 04 08
		40	50.0	35°	160.0	60.0	A40T-SVQBR/L 16	40.0	37.0	40.0	300.0	27.0	10	3.0	2.51	VBMT 16 04 08
11		16	22.0	50°	64.0	24.0	A16R-SVUBR/L 11-E	16.0	15.0	16.0	200.0	13.0	10	0.9	0.29	VBMT 11 02 04
	16	16	22.0	50°	64.0	24.0	A16R-SVUBR/L 11-EB1	16.0	15.0	16.0	200.0	13.0	10	0.9	0.28	VBMT 11 03 04
		20	27.0	50°	80.0	30.0	A20S-SVUBR/L 11-E	20.0	18.0	20.0	250.0	15.0	10	0.9	0.54	VBMT 11 02 04
		20	27.0	50°	80.0	30.0	A20S-SVUBR/L 11-EB1	20.0	18.0	20.0	250.0	15.0	10	0.9	0.58	VBMT 11 03 04
		25	33.0	50°	100.0	37.5	A25T-SVUBR/L 11-D	25.0	23.0	25.0	300.0	18.0	10	0.9	0.96	VBMT 11 02 04
	16	25	33.0	50°	100.0	37.5	A25T-SVUBR/L 11-DB1	25.0	23.0	25.0	300.0	18.0	10	0.9	0.96	VBMT 11 03 04
		25	33.0	50°	100.0	37.5	A25T-SVUBR/L 16-D	25.0	23.0	25.0	300.0	18.0	10	3.0	0.96	VBMT 16 04 08
		32	40.0	50°	128.0	48.0	A32T-SVUBR/L 16	32.0	30.0	32.0	300.0	22.0	10	3.0	1.50	VBMT 16 04 08
		40	50.0	50°	160.0	60.0	A40T-SVUBR/L 16	40.0	37.0	40.0	300.0	27.0	10	3.0	2.54	VBMT 16 04 08

B1 = Para pastilha com espessura de 03 = 3.18 mm.

R = versão direita, L = versão esquerda

	Componentes			
	CZC _{MS}	Parafuso da pastilha	Calço	Parafuso do calço
11	16-25	5513 020-20		
16	25	5513 020-10		
16	32-40	5513 020-01	5322 270-01	5512 090-01

Para a lista completa de componentes, acesse www.sandvik.coromant.com



Barra de mandrilar CoroTurn® 107 para mandrilamento reverso

Fixação por parafuso

Cilíndrica com canal para bucha EasyFix - Refrigeração interna

B



KAPR

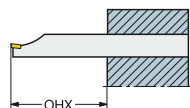

93.0°

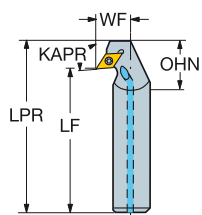

C



- DCMT, DCMX
DCGT, DCGX, DCET
- DCMW

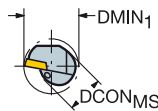

D

Código para pedido	Dimensões, mm										BAR	NM	KG	MIID	
	CZC _{MS}	DMIN ₁	RMPX	OHX	OHN	CNSC	DCON _{MS}	BD	LPR	LF					WF
A16R-SDUCR/L 07-ERX	16	22.0	27°	64.0	24.0	1	16.0	16.0	212.9	200.0	13.0	10	0.9	0.31	DCMT 07 02 04
A20S-SDUCR/L 07-ERX	20	27.0	27°	80.0	30.0	1	20.0	20.0	262.9	250.0	15.0	10	0.9	0.60	DCMT 07 02 04

R = versão direita, L = versão esquerda

Componentes

Parafuso da pastilha
5513 020-03

Para a lista completa de componentes, acesse www.sandvik.coromant.com

F

G

H



Barra de mandrilar CoroTurn® 107 para mandrilamento reverso

Fixação por parafuso

Cilíndrica com planos - Refrigeração interna



- DCMT, DCMX
- DCGT, DCGX, DCET
- DCMW

KAPR

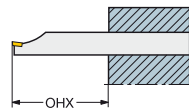

93.0°

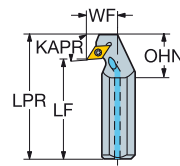

								Dimensões, mm										MIID	
	CZC _{MS}	DMIN ₁	RMPX	OHX	OHN	CNSC	Código para pedido	DCON _{MS}	H	BD	LPR	LF	WF	BAR	NM	KG			
	07	16	22.0	27°	64.0	24.0	1	A16R-SDUCR/L 07-EX	16.0	15.0	16.0	212.2	200.0	13.0	10	0.9	0.31	DCMT 07 02 04	
			20	27.0	27°	80.0	30.0	1	A20S-SDUCR/L 07-EX	20.0	18.0	20.0	262.2	250.0	15.0	10	0.9	0.56	DCMT 07 02 04
			25	33.0	27°	100.0	37.5	1	A25T-SDUCR/L 07-DX	25.0	23.0	25.0	312.2	300.0	18.0	10	0.9	0.92	DCMT 07 02 04
			11	32	40.0	27°	128.0	48.0	1	A32T-SDUCR/L 11-X	32.0	30.0	32.0	316.7	300.0	22.0	10	3.0	1.76

R = versão direita, L = versão esquerda

Componentes				
	CZC _{MS}	Parafuso da pastilha	Calço	Parafuso do calço
07	16-25	5513 020-03		
11	32	5513 020-01	5322 263-01	5512 090-01

Para a lista completa de componentes, acesse www.sandvik.coromant.com



A11



F2



G1



H36



H10



H5

A TORNEAMENTO GERAL

Ferramentas internas

Barra de mandrilar CoroTurn® 107 inteiriça de metal duro para torneamento

Fixação por parafuso

Cilíndrica com canal para bucha EasyFix - Refrigeração interna

B 

KAPR

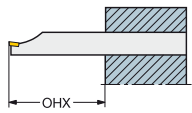

95.0°

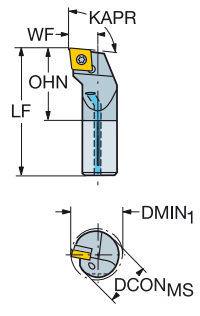

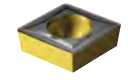
C 

 CCMT, CCGT
CCGX, CCET
 CCMW

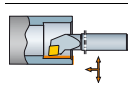
D 

CZC _{MS}	DMIN ₁	OHX	OHN	CNSC	Código para pedido	Dimensões, mm						MIID	
						D _{CONMS}	BD	LF	WF	BAR	NM		KG
06	8	10.0	48.0	17.0	E08K-SCLCR/L 06-R	8.0	8.0	125.0	5.0	10	0.9	0.09	CCMT 06 02 04
	10	12.0	60.0	21.0	E10M-SCLCR/L 06-R	10.0	10.0	150.0	6.0	10	0.9	0.15	CCMT 06 02 04
	12	16.0	72.0	25.0	E12Q-SCLCR/L 06-R	12.0	12.0	180.0	9.0	10	0.9	0.26	CCMT 06 02 04
	16	20.0	96.0	33.0	E16R-SCLCR/L 06-R	16.0	16.0	200.0	11.0	10	0.9	0.50	CCMT 06 02 04
09	16	20.0	96.0	33.0	E16R-SCLCR/L 09-R	16.0	16.0	200.0	11.0	10	3.0	0.50	CCMT 09 T3 08
	20	25.0	120.0	36.3	E20S-SCLCR/L 09-R	20.0	20.0	220.0	13.0	10	3.0	0.86	CCMT 09 T3 08
	25	32.0	150.0	41.3	E25T-SCLCR/L 09-R	25.0	25.0	270.0	17.0	10	3.0	1.58	CCMT 09 T3 08

R = versão direita, L = versão esquerda

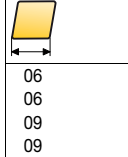
E 

Componentes		
CZC _{MS}	Parafuso da pastilha	
06	8-12	5513 020-46
06	16	5513 020-03
09	16-20	5513 020-09
09	25	5513 020-10

Para a lista completa de componentes, acesse www.sandvik.coromant.com

F

G

H

 A41
  F2
  G1
  ISO 13399
  G3 - D3
  H10
  H5
  CNSC CXSC

A 124



Barra de mandrilar CoroTurn® 107 inteiriça de metal duro para torneamento

Fixação por parafuso

Cilíndrica com canal para bucha EasyFix - Refrigeração interna



- DCMT, DCMX
DCGT, DCGX, DCET
- DCMW

KAPR

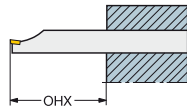

93.0°

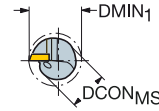
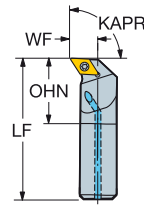

								Dimensões, mm							MIID	
	CZC _{MS}	DMIN ₁	RMPX	OHX	OHN	CNSC	Código para pedido	DCON _{MS}	BD	LF	WF	BAR	NM	KG		
	07	10	15.0	27°	60.0	25.0	1	E10M-SDUCR/L 07-ER	10.0	10.0	150.0	9.0	10	0.9	0.15	DCMT 07 02 04
		12	18.0	27°	72.0	30.0	1	E12Q-SDUCR/L 07-ER	12.0	12.0	180.0	11.0	10	0.9	0.25	DCMT 07 02 04
		16	22.0	27°	96.0	33.3	1	E16R-SDUCR/L 07-ER	16.0	16.0	200.0	13.0	10	0.9	0.48	DCMT 07 02 04
	11	20	25.0	27°	120.0	36.3	1	E20S-SDUCR/L 11-R	20.0	20.0	220.0	13.0	10	3.0	0.86	DCMT 11 T3 08
		25	32.0	27°	150.0	41.3	1	E25T-SDUCR/L 11-R	25.0	25.0	270.0	17.0	10	3.0	1.58	DCMT 11 T3 08

R = versão direita, L = versão esquerda

		Componentes
	CZC _{MS}	Parafuso da pastilha
07	10-16	5513 020-03
11	20	5513 020-09
11	25	5513 020-10

Para a lista completa de componentes, acesse www.sandvik.coromant.com



A11



F2



G1



H36



H10



H5

Barra de mandrilar CoroTurn® 107 inteiriça de metal duro para torneamento

Fixação por parafuso

Cilíndrica com canal para bucha EasyFix - Refrigeração interna

B



KAPR

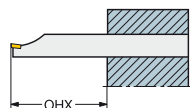

91.0°

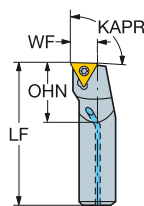

C



- TCMT, TCMX, TCGT, TCGX, TCEX
- TCMW

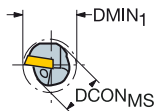

D

CZC _{MS}	DMIN ₁	OHX	OHN	CNSC	Código para pedido	Dimensões, mm							MIID
						DCON _{MS}	BD	LF	WF	BAR	NM	KG	
06	6	8.5	36.0	15.0	E06H-STFCR/L 06-R	6.0	6.0	100.0	4.5	10	0.6	0.05	TCMT 06 T1 02
	8	11.0	48.0	20.0	E08K-STFCR/L 06-R	8.0	8.0	125.0	5.9	10	0.6	0.09	TCMT 06 T1 02
09	10	13.0	60.0	25.0	E10M-STFCR/L 09-R	10.0	10.0	150.0	7.0	10	0.9	0.15	TCMT 09 02 04
	12	16.0	72.0	30.0	E12Q-STFCR/L 09-R	12.0	12.0	180.0	9.0	10	0.9	0.25	TCMT 09 02 04
11	16	20.0	96.0	33.2	E16R-STFCR/L 11-R	16.0	16.0	200.0	11.0	10	0.9	0.49	TCMT 11 02 04
	16	20.0	96.0	40.0	E16R-STFCR/L 11-RB1	16.0	16.0	200.0	11.0	10	0.9	0.50	TCMT 11 03 04
	20	25.0	120.0	36.3	E20S-STFCR/L 11-RB1	20.0	20.0	220.0	13.0	10	0.9	0.85	TCMT 11 03 04
	25	32.0	150.0	41.5	E25T-STFCR 11-RB1	25.0	25.0	270.0	17.0	10	0.9	1.58	TCMT 11 03 04
16	25	32.0	150.0	41.5	E25T-STFCR/L 16-R	25.0	25.0	270.0	17.0	10	3.0	1.58	TCMT 16 T3 08

B1 = Para pastilha com espessura de 03 = 3.18 mm.

R = versão direita, L = versão esquerda

E

Componentes	
CZC _{MS}	Parafuso da pastilha
06	6
06	8
09	10-12
11	16-25
16	25

Para a lista completa de componentes, acesse www.sandvik.coromant.com

F

G

H



Barra de mandrilar CoroTurn® 107 inteiriça de metal duro para torneamento

Fixação por parafuso

Cilíndrica com canal para bucha EasyFix - Refrigeração interna



 TCEX

KAPR

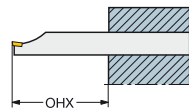

93.0°

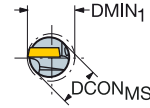
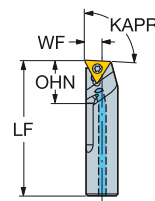

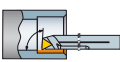
							Dimensões, mm							MIID
	CZC _{MS}	DMIN ₁	OHX	OHN	CNSC	Código para pedido	DCON _{MS}	BD	LF	WF	BAR	NM	KG	
05	5	6.0	30.0	12.0	1	E05H-STUCR/L 05-GR	5.0	5.0	100.0	2.9	10	0.4	0.04	TCEX 05 01 00R-F
	6	7.0	36.0	13.0	1	E06H-STUCR/L 05-GR	6.0	6.0	100.0	3.2	10	0.4	0.05	TCEX 05 01 00R-F
06	8	9.0	48.0	17.0	1	E08K-STUCR/L 06-GR	8.0	8.0	125.0	4.2	10	0.6	0.08	TCEX 06 T1 00R-F
	10	11.0	60.0	20.0	1	E10M-STUCR/L 06-GR	10.0	10.0	150.0	5.2	10	0.6	0.14	TCEX 06 T1 00R-F

A barra de mandrilar versão direita (R) usa pastilhas TCEX versão esquerda (L) e vice-versa.

R = versão direita, L = versão esquerda

		Componentes
	CZC _{MS}	Parafuso da pastilha
05	5-6	5513 020-53
06	8	5513 020-44
06	10	5513 020-28

Para a lista completa de componentes, acesse www.sandvik.coromant.com



A

TORNEAMENTO GERAL

Ferramentas internas

Barra de mandrilar CoroTurn® 107 inteiriça de metal duro para torneamento

Fixação por parafuso

Cilíndrica com canal para bucha EasyFix - Refrigeração interna

B



KAPR

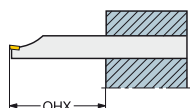
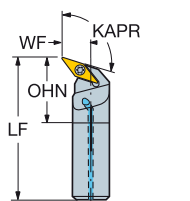
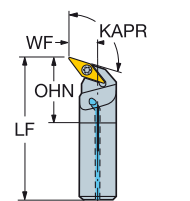

E..SVUCR/L-ER
93.0°

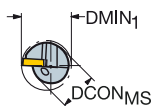
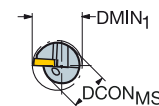
E..SVQCR/L-ER
107.5°

C

 VCMT, VCEX,
VCGX
 VCMW

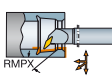
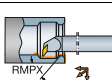
D

		Dimensões, mm														
		CZC _{MS}	DMIN ₁	RMPX	OHX	OHN	CNSC	Código para pedido	DCON _{MS}	BD	LF	WF	BAR	NM	KG	MIID
	11	16	22.0	35°	96.0	33.0	1	E16R-SVQCR/L 11-ER	16.0	16.0	200.0	13.0	10	0.9	0.49	VCMT 11 03 04
	11	16	22.0	50°	96.0	33.0	1	E16R-SVUCR/L 11-ER	16.0	16.0	200.0	13.0	10	0.9	0.50	VCMT 11 03 04

R = versão direita, L = versão esquerda

E

Componentes
Parafuso da pastilha
5513 020-03

Para a lista completa de componentes, acesse www.sandvik.coromant.com

F

G

H

 A41

 F2

 G1

 H36

 H10

 H5

A 128



Barra de mandrilar CoroTurn® 107 de metal duro antivibratória para torneamento

Fixação por parafuso

Cilíndrica com canal para bucha EasyFix



- DCMT, DCMX
DCGT, DCGX, DCET
- DCMW

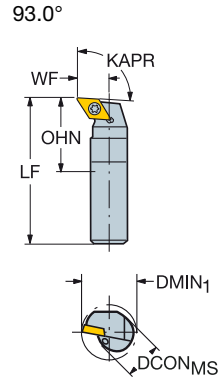
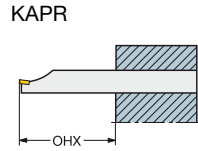

	Dimensões, mm											MIID		
	CZC _{MS}	DMIN ₁	RMPX	OHX	OHN	Código para pedido	DCON _{MS}	BD	LF	WF	NM		KG	
	07	10	15.0	27°	100.0	60.0	F10M-SDUCR/L 07-ER	10.0	10.0	150.0	9.0	0.9	0.18	DCMT 07 02 04
		12	18.0	27°	120.0	72.0	F12Q-SDUCR/L 07-ER	12.0	12.0	180.0	11.0	0.9	0.29	DCMT 07 02 04

R = versão direita, L = versão esquerda

Componentes
Parafuso da pastilha
5513 020-03

Para a lista completa de componentes, acesse www.sandvik.coromant.com



Barra de mandrilar CoroTurn® 107 de metal duro antivibratória para torneamento

Fixação por parafuso

Cilíndrica com canal para bucha EasyFix

B

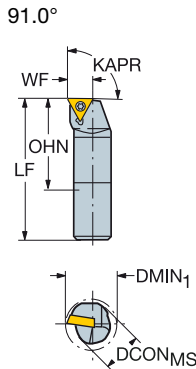
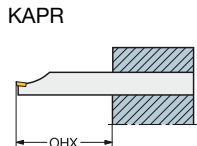

C



- TCMT, TCMX, TCGT, TCGX, TCEX
- TCMW

D

Código para pedido	Dimensões, mm										MIID
	CZC _{MS}	D _{MIN1}	OHX	OHN	D _{CONMS}	BD	LF	WF	NM	KG	
F10M-STFCR/L 09-R	10	13.0	100.0	60.0	10.0	10.0	150.0	7.0	0.9	0.18	TCMT 09 02 04
F12Q-STFCR/L 09-R	12	16.0	120.0	72.0	12.0	12.0	180.0	9.0	0.9	0.29	TCMT 09 02 04

R = versão direita, L = versão esquerda

Componentes
Parafuso da pastilha
5513 020-05

Para a lista completa de componentes, acesse www.sandvik.coromant.com

F

G

H



Cabeça CoroTurn® 107 para torneamento

Fixação por parafuso

CoroTurn® SL - Refrigeração de precisão

KAPR

95.0°

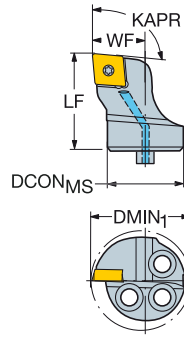

- CCMT, CCGT
CCGX, CCET
- CCMW

B

C

					Código para pedido	Dimensões, mm						MIID
	CZC _{MS}	DMIN ₁	CNSC			DCON _{MS}	LF	WF	BAR	NM	KG	
	09	25	32.0	1	SL-SCLCR/L-25-09HP	25.0	20.0	17.0	80	3.0	0.07	CCMT 09 T3 08
		32	40.0	1	SL-SCLCR/L-32-09HP	32.0	32.0	22.0	80	3.0	0.13	CCMT 09 T3 08
	12	40	50.0	1	SL-SCLCR/L-40-12HP	40.0	38.0	27.0	80	3.0	0.24	CCMT 12 04 08

R = versão direita, L = versão esquerda

D

Código para pedido	Componentes				
	Parafuso da pastilha	Calço	Parafuso do calço	Tubo de localização	Olhal
SL-SCLCR/L-25-09HP	5513 020-09			5552 058-02	5691 026-13
SL-SCLCR/L-32-09HP	5513 020-09			5638 031-01	5691 026-13
SL-SCLCR/L-40-12HP	5513 020-18	5322 232-02	5512 090-03	5638 031-01	5691 026-03

Para a lista completa de componentes, acesse www.sandvik.coromant.com

E

F

G

H



Cabeça CoroTurn® 107 para torneamento

Fixação por parafuso

CoroTurn® SL - Refrigeração interna

KAPR

95.0°

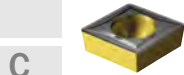
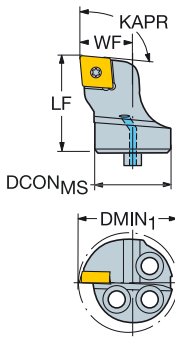

- CCMT, CCGT
CCGX, CCET
- CCMW

D	Dimensões, mm				Dimensões, mm							MIID
	CZC _{MS}	DMIN ₁	CNSC	Código para pedido	DCON _{MS}	LF	WF	BAR	NM	KG		
	06	16	20.0	1	570-SCLCR/L-16-06	16.0	20.0	11.0	10	0.9	0.03	CCMT 06 02 04
	09	20	25.0	1	570-SCLCR/L-20-09	20.0	20.0	13.0	10	3.0	0.05	CCMT 09 T3 08
	25	32.0	1	570-SCLCR/L-25-09	25.0	20.0	17.0	10	3.0	0.07	CCMT 09 T3 08	
	32	40.0	1	570-SCLCR/L-32-09	32.0	32.0	22.0	10	3.0	0.13	CCMT 09 T3 08	
	12	40	50.0	1	570-SCLCR/L-40-12	40.0	38.0	27.0	10	3.0	0.24	CCMT 12 04 08

R = versão direita, L = versão esquerda

E	Componentes				
	Código para pedido	Parafuso da pastilha	Calço	Parafuso do calço	Tubo de localização
	570-SCLCR/L-16-06	5513 020-03			5552 058-01
	570-SCLCR/L-20-09	5513 020-09			5552 058-02
	570-SCLCR/L-25-09	5513 020-10			5552 058-02
	570-SCLCR/L-32-09	5513 020-09			5638 031-01
	570-SCLCR/L-40-12	5513 020-18	5322 232-02	5512 090-03	5638 031-01

Para a lista completa de componentes, acesse www.sandvik.coromant.com



Cabeça CoroTurn® 107 para torneamento

Fixação por parafuso

CoroTurn® SL Troca Rápida

KAPR

95.0°

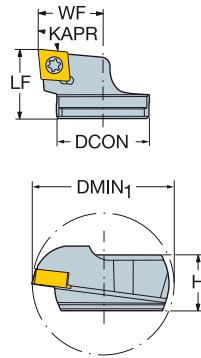

- CCMT, CCGT
CCGX, CCET
- CCMW

						Dimensões, mm							
		CZC _{MS}	DMIN ₁	Código para pedido	DCON _{MS}	H	LF	WF	NM	KG	MIID		
	09	32	40.0	SL-SCLCR-32-09-QC	32.0	14.7	22.0	21.0	3.0	0.08	CCMT 09 T3 08		

R = versão direita, L = versão esquerda

Componentes			
Código para pedido	Parafuso	Tubo de localização	Parafuso de ajuste
SL-SCLCR-32-09-QC	5513 020-10	5638 031-01	5514 060-10

Para a lista completa de componentes, acesse www.sandvik.coromant.com



Cabeça CoroTurn® 107 para torneamento

Fixação por parafuso

CoroTurn® SL - Refrigeração de precisão

B

KAPR

SL-SDXCR/L-DHP
62.5°

SL-SDUCR/L...HP
93.0°

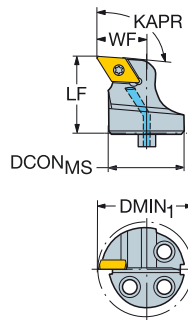
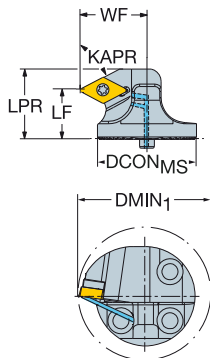

C



- DCMT, DCMX
- DCGT, DCGX, DCET
- DCMW

D

	Dimensões, mm									MID				
	CZC _{MS}	DMIN ₁	RMPX	CNSC	Código para pedido	DCON _{MS}	LPR	LF	WF		BAR	NM	KG	
	11	25	32.0	27°	1	SL-SDUCR/L-25-11HP	25.0	23.0	17.0	80	3.0	0.08	DCMT 11 T3 08	
		32	40.0	27°	1	SL-SDUCR/L-32-11HP	32.0	32.0	22.0	80	3.0	0.14	DCMT 11 T3 08	
		40	50.0	27°	1	SL-SDUCR/L-40-11HP	40.0	32.0	27.0	80	3.0	0.21	DCMT 11 T3 08	
	11	32	40.0	60°	1	SL-SDXCR/L-32-11HP	32.0	28.0	20.0	22.0	80	3.0	0.12	DCMT 11 T3 08
		40	50.0	60°	1	SL-SDXCR/L-40-11HP	40.0	28.0	20.0	27.0	80	3.0	0.19	DCMT 11 T3 08
		07	25	33.0	60°	1	SL-SDXCR/L-25-07-DHP	25.0	19.7	15.0	18.0	80	0.9	0.07

R = versão direita, L = versão esquerda

E

Componentes					
Código para pedido	Parafuso da pastilha	Calço	Parafuso do calço	Tubo de localização	Olhal
SL-SDXCR/L-25-07-DHP	5513 020-03			5552 058-02	5691 026-13
SL-SDUCR/L-25-11HP	5513 020-10			5552 058-02	5691 026-13
SL-SDUCR/L-32-11HP	5513 020-01	5322 263-01	5512 090-01	5638 031-01	5691 026-13
SL-SDXCR/L-32-11HP	5513 020-01	5322 263-01	5512 090-01	5638 031-01	5691 026-13
SL-SDUCR/L-40-11HP	5513 020-01	5322 263-01	5512 090-01	5638 031-01	5691 026-03
SL-SDXCR/L-40-11HP	5513 020-01	5322 263-01	5512 090-01	5638 031-01	5691 026-03

Para a lista completa de componentes, acesse www.sandvik.coromant.com

F

G

H



Cabeça CoroTurn® 107 para torneamento

Fixação por parafuso

CoroTurn® SL - Refrigeração interna

KAPR

570-SDXCR/L
62.5°

570-SDUCR/L
93.0°

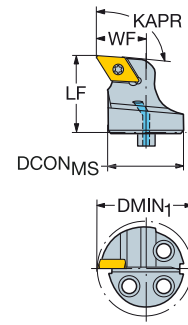
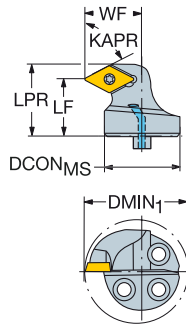

- DCMT, DCMX
DCGT, DCGX, DCET
- DCMW

							Dimensões, mm							MID
		CZC _{MS}	DMIN ₁	RMPX	CNSC	Código para pedido	DCON _{MS}	LPR	LF	WF	BAR	NM	KG	
	07	16	20.0	27°	8	570-SDUCR/L-16-07	16.0		20.0	11.0	10	0.9	0.03	DCMT 07 02 04
	11	20	25.0	27°	8	570-SDUCR/L-20-11	20.0		20.0	13.0	10	3.0	0.05	DCMT 11 T3 08
		25	32.0	27°	8	570-SDUCR/L-25-11	25.0		20.0	17.0	10	3.0	0.07	DCMT 11 T3 08
		32	40.0	27°	1	570-SDUCR/L-32-11	32.0		32.0	22.0	10	3.0	0.13	DCMT 11 T3 08
		40	50.0	27°	1	570-SDUCR/L-40-11	40.0		32.0	27.0	10	3.0	0.20	DCMT 11 T3 08
	07	16	22.0	60°	1	570-SDXCR/L-16-07-E	16.0	18.8	15.0	13.0	10	0.9	0.03	DCMT 07 02 04
		20	27.0	60°	1	570-SDXCR/L-20-07-E	20.0	18.8	15.0	15.0	10	0.9	0.04	DCMT 07 02 04
		25	33.0	60°	1	570-SDXCR/L-25-07-D	25.0	18.8	15.0	18.0	10	0.9	0.06	DCMT 07 02 04
	11	32	40.0	60°	1	570-SDXCR/L-32-11	32.0	28.0	20.0	22.0	10	3.0	0.12	DCMT 11 T3 08
		40	50.0	60°	1	570-SDXCR/L-40-11	40.0	28.0	20.0	27.0	10	3.0	0.18	DCMT 11 T3 08

R = versão direita, L = versão esquerda

Componentes					
	CZC _{MS}	Parafuso da pastilha	Calço	Parafuso do calço	Tubo de localização
07	16	5513 020-03			5552 058-01
07	20-25	5513 020-03			5552 058-02
11	20	5513 020-09			5552 058-02
11	25	5513 020-10			5552 058-02
11	32-40	5513 020-01	5322 263-01	5512 090-01	5638 031-01

Para a lista completa de componentes, acesse www.sandvik.coromant.com



Cabeça CoroTurn® 107 para torneamento

Fixação por parafuso

CoroTurn® SL Troca Rápida

B



KAPR

570-SDUCR/L-80
93.0°

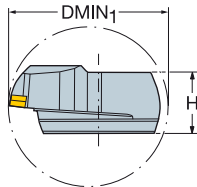
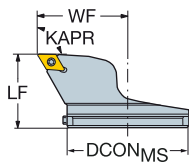

C



- DCMT, DCMX
DCGT, DCGX, DCET
- DCMW

D

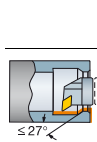

		Dimensões, mm										
		CZC _{MS}	DMIN ₁	RMPX	Código para pedido	DCON _{MS}	H	LF	WF			MIID
	11	80	100.0	27°	570-SDUCR/L-80-11	80.0	37.5	45.7	57.0	3.0	0.55	DCMT 11 T3 08

R = versão direita, L = versão esquerda

E

Componentes				
Código para pedido	Parafuso da pastilha	Calço	Parafuso do calço	Parafuso de ajuste
570-SDUCR/L-80-11	5513 020-01	5322 263-01	5512 090-01	3214 020-311

Para a lista completa de componentes, acesse www.sandvik.coromant.com

F

G

H



Cabeça CoroTurn® 107 para torneamento

Fixação por parafuso

CoroTurn® SL Troca Rápida

KAPR

SL-SDXCR/L-QC
62.5°

SL-SDUCR/L-QC
93.0°



- DCMT, DCMX
- DCGT, DCGX, DCET
- DCMW

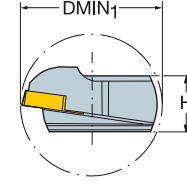
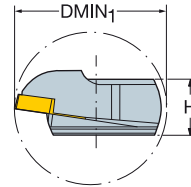
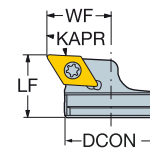
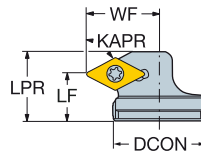

		Dimensões, mm										MID	
		CZC _{MS}	DMIN ₁	RMPX	Código para pedido	DCON _{MS}	H	LPR	LF	WF	NM		KG
	11	32	40.0	27°	SL-SDUCR-32-11-QC	32.0	14.7	20.0	21.0	3.0	0.08	DCMT 11 T3 08	
	11	32	40.0	60°	SL-SDXCR-32-11-QC	32.0	14.7	22.0	15.0	24.0	3.0	0.08	DCMT 11 T3 08

R = versão direita, L = versão esquerda

Código para pedido	Componentes		
	Parafuso	Tubo de localização	Parafuso de ajuste
SL-SDUCR-32-11-QC	5513 020-10	5638 031-01	5514 060-10
SL-SDXCR-32-11-QC	5513 020-10	5638 031-01	5514 060-10

Para a lista completa de componentes, acesse www.sandvik.coromant.com



Cabeça CoroTurn® 107 para torneamento

Fixação por parafuso

CoroTurn® SL70 - Refrigeração de precisão

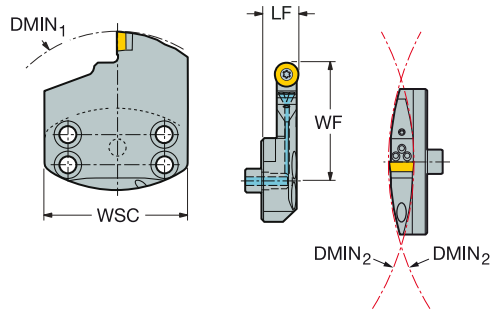

C RCMT RCGX-AL

D	CZC _{MS}	DMIN ₁	DMIN ₂	CNSC	Código para pedido	Dimensões, mm						MIID		
						BD	LF	WF	WSC	BAR	NM		KG	
	10	70	120.0	250.0	1	SL70-SRDCR/L-20-10HP	70.0	17.0	41.0	70.0	30	3.0	0.31	RCMT 10 T3 M0
	70	120.0	250.0	1	SL70-SRDCR/L-35-10HP	70.0	17.0	56.0	70.0	30	3.0	0.35	RCMT 10 T3 M0	
	12	70	120.0	300.0	1	SL70-SRDCR/L-35-12HP	70.0	18.0	56.0	70.0	30	3.0	0.40	RCMT 12 04 M0
	70	120.0	260.0	1	SL70-SRDCR/L-50-12HP	70.0	18.0	71.0	70.0	30	3.0	0.42	RCMT 12 04 M0	
	70	120.0	260.0	1	SL70-SRDCR/L-75-12HP	70.0	18.0	96.0	70.0	30	3.0	0.51	RCMT 12 04 M0	

R = versão direita, L = versão esquerda

Componentes					
Código para pedido	Parafuso	Calço	Parafuso do calço	Olhal	Bucha-guia
SL70-SRDCR/L-20-10HP	5513 020-10	5322 110-01	5512 090-01	5691 026-13	5552 058-04
SL70-SRDCR/L-35-10HP	5513 020-10	5322 110-01	5512 090-01	5691 026-13	5552 058-04
SL70-SRDCR/L-35-12HP	5513 020-01	5322 110-02	5512 090-01	5691 026-03	5552 058-04
SL70-SRDCR/L-50-12HP	5513 020-01	5322 110-02	5512 090-01	5691 026-13	5552 058-04
SL70-SRDCR/L-75-12HP	5513 020-01	5322 110-02	5512 090-01	5691 026-13	5552 058-04

Para a lista completa de componentes, acesse www.sandvik.coromant.com



Cabeça CoroTurn® 107 para torneamento

Fixação por parafuso

CoroTurn® SL - Refrigeração de precisão

KAPR

91.0°

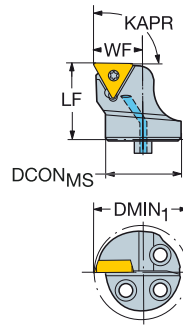

- TCMT, TCMX, TCGT, TCGX, TCEX
- TCMW

					Código para pedido	Dimensões, mm						MIID
		CZC _{MS}	DMIN ₁	CNSC		DCON _{MS}	LF	WF	BAR	NM	KG	
	11	25	32.0	1	SL-STFCR/L-25-11-B1HP	25.0	20.0	17.0	80	0.9	0.07	TCMT 11 03 04
	16	32	40.0	1	SL-STFCR/L-32-16HP	32.0	32.0	22.0	80	3.0	0.14	TCMT 16 T3 08
		40	50.0	1	SL-STFCR/L-40-16HP	40.0	32.0	27.0	80	3.0	0.22	TCMT 16 T3 08

B1 = Para pastilha com espessura de 03 = 3.18 mm.

R = versão direita, L = versão esquerda

Código para pedido	Componentes				
	Parafuso da pastilha	Calço	Parafuso do calço	Tubo de localização	Olhal
SL-STFCR/L-25-11-B1HP	5513 020-03			5552 058-02	5691 026-13
SL-STFCR/L-32-16HP	5513 020-01	5322 320-01	5512 090-01	5638 031-01	5691 026-13
SL-STFCR/L-40-16HP	5513 020-01	5322 320-01	5512 090-01	5638 031-01	5691 026-03

Para a lista completa de componentes, acesse www.sandvik.coromant.com



Cabeça CoroTurn® 107 para torneamento

Fixação por parafuso

CoroTurn® SL

KAPR

91.0°

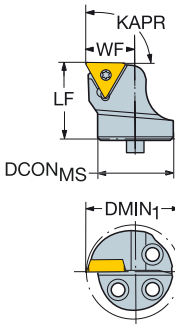

- TCMT, TCMX, TCGT, TCGX, TCEX
- TCMW

C

D

CZC _{MS}	DMIN ₁	CNCS	Código para pedido	Dimensões, mm					MIID	
				DCON _{MS}	LF	WF	NM	KG		
09	16	20.0	8	570-STFCR/L-16-09	16.0	20.0	11.0	0.9	0.03	TCMT 09 02 04
11	16	20.0	8	570-STFCR/L-16-11-B1	16.0	20.0	11.0	0.9	0.03	TCMT 11 03 04
20	20	25.0	8	570-STFCR/L-20-11-B1	20.0	20.0	13.0	0.9	0.04	TCMT 11 03 04
25	32.0	8	8	570-STFCR/L-25-11-B1	25.0	20.0	17.0	0.9	0.06	TCMT 11 03 04
16	32	40.0	1	570-STFCR/L-32-16	32.0	32.0	22.0	3.0	0.14	TCMT 16 T3 08
40	40	50.0	1	570-STFCR/L-40-16	40.0	32.0	27.0	3.0	0.21	TCMT 16 T3 08

B1 = Para pastilha com espessura de 03 = 3.18 mm.

R = versão direita, L = versão esquerda

E

Código para pedido	Componentes			
	Parafuso da pastilha	Calço	Parafuso do calço	Tubo de localização
570-STFCR/L-16-09	5513 020-05			5552 058-01
570-STFCR/L-16-11-B1	5513 020-03			5552 058-01
570-STFCR/L-20-11-B1	5513 020-03			5552 058-02
570-STFCR/L-25-11-B1	5513 020-03			5552 058-02
570-STFCR/L-32-16	5513 020-01	5322 320-01	5512 090-01	5638 031-01
570-STFCR/L-40-16	5513 020-01	5322 320-01	5512 090-01	5638 031-01

Para a lista completa de componentes, acesse www.sandvik.coromant.com

F

G

H



Cabeça CoroTurn® 107 para torneamento

Fixação por parafuso

CoroTurn® SL - Refrigeração de precisão

KAPR

SL-SVPBR/L..LHP
117.5°

SL-SVLBR/L..HP
95.0°



- VBMT, VBGT
VCGX, VCEX,
VCGT, VCET
- VBMT, VCMW

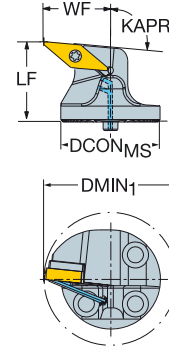
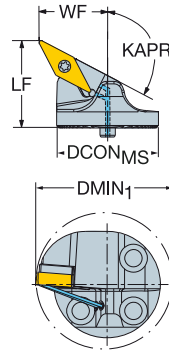

						Dimensões, mm							MIID
		CZC _{MS}	DMIN ₁	RMPX	CNSC	Código para pedido	DCON _{MS}	LF	WF	BAR	NM	KG	
	16	32	40.0	45°	1	SL-SVLBR/L-32-16HP	32.0	32.0	22.0	80	3.0	0.13	VBMT 16 04 08
		40	50.0	45°	1	SL-SVLBR/L-40-16HP	40.0	32.0	27.0	80	3.0	0.19	VBMT 16 04 08
		25	35.0	45°	1	SL-SVLBR/L-25-16-LFHP	25.0	25.0	20.0	80	3.0	0.08	VBMT 16 04 08
	16	32	40.0	25°	1	SL-SVPBR/L-32-16-LHP	32.0	34.0	22.0	80	3.0	0.12	VBMT 16 04 08
		40	50.0	25°	1	SL-SVPBR/L-40-16-LHP	40.0	34.0	27.0	80	3.0	0.17	VBMT 16 04 08

R = versão direita, L = versão esquerda

Componentes						
	CZC _{MS}	Parafuso da pastilha	Calço	Parafuso do calço	Tubo de localização	Olhal
16	25	5513 020-10			5552 058-02	5691 026-13
16	32-40	5513 020-01	5322 270-01	5512 090-01	5638 031-01	5691 026-13

Para a lista completa de componentes, acesse www.sandvik.coromant.com



Cabeça CoroTurn® 107 para torneamento

Fixação por parafuso

CoroTurn® SL - Refrigeração interna

B KAPR

570-SVUCR/L
93.0°

570-SVQCR/L
107.5°

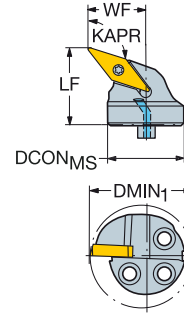
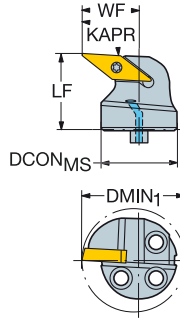

- C
- VCMT, VCEX, VCGX
 - VCMW

D

		Dimensões, mm											
		CZC _{MS}	DMIN ₁	RMPX	CNSC	Código para pedido	DCON _{MS}	LF	WF				MIID
	11	20	27.0	35°	1	570-SVQCR/L-20-11-E	20.0	20.0	15.0	10	0.9	0.04	VCMT 11 03 04
	25		33.0	35°	1	570-SVQCR/L-25-11-D	25.0	20.0	18.0	10	0.9	0.05	VCMT 11 03 04
	11	20	27.0	45°	1	570-SVUCR/L-20-11-E	20.0	20.0	15.0	10	0.9	0.05	VCMT 11 03 04
	25		33.0	45°	1	570-SVUCR/L-25-11-D	25.0	20.0	18.0	10	0.9	0.06	VCMT 11 03 04

R = versão direita, L = versão esquerda

Componentes

Parafuso da pastilha	Tubo de localização
5513 020-03	5552 058-02

Para a lista completa de componentes, acesse www.sandvik.coromant.com

F

G

H



Cabeça CoroTurn® 107 para torneamento

Fixação por parafuso

CoroTurn® SL - Refrigeração interna



KAPR

570-SVPBR/L
117.5°

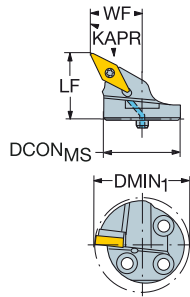

570-SVLBR/L
95.0°

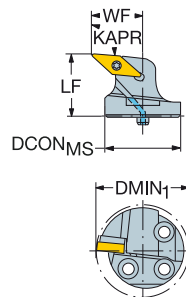

570C-SVUBR/L
93.0°

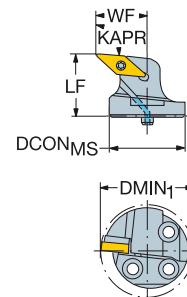

- VBMT, VBGT
VCGX, VCEX,
VCGT, VCET
- VBWM, VCMW

						Dimensões, mm							MID
	CZC _{MS}	DMIN ₁	RMPX	CNSC	Código para pedido	DCON _{MS}	LF	WF	BAR	NM	KG		
	11	20	27.0	50°	1	570C-SVUBR/L-20-2	20.0	20.0	16.0	10	0.9	0.04	VBMT 11 02 04
		25	31.0	50°	1	570C-SVUBR/L-25-2	25.0	25.0	17.0	10	0.9	0.07	VBMT 11 02 04
	16	25	35.0	45°	1	570-SVLBR/L-25-16-LF	25.0	22.0	20.0	10	3.0	0.07	VBMT 16 04 08
		32	40.0	45°	1	570-SVLBR/L-32-16	32.0	32.0	22.0	10	3.0	0.13	VBMT 16 04 08
		40	50.0	45°	1	570-SVLBR/L-40-16	40.0	32.0	27.0	10	3.0	0.18	VBMT 16 04 08
	16	32	40.0	25°	1	570-SVPBR/L-32-16-L	32.0	34.0	22.0	10	3.0	0.12	VBMT 16 04 08
		40	50.0	25°	1	570-SVPBR/L-40-16-L	40.0	34.0	27.0	10	3.0	0.17	VBMT 16 04 08

R = versão direita, L = versão esquerda

Componentes					
	CZC _{MS}	Parafuso da pastilha	Calço	Parafuso do calço	Tubo de localização
11	20-25	5513 020-03			5552 058-02
16	25	5513 020-10			5552 058-02
16	32-40	5513 020-10	5322 270-01	5512 090-01	5638 031-01

Para a lista completa de componentes, acesse www.sandvik.coromant.com



Cabeça CoroTurn® 107 para torneamento

Fixação por parafuso

CoroTurn® SL Troca Rápida

KAPR

95.0°

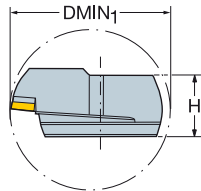
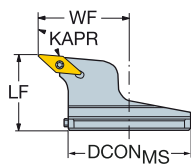

- VBMT, VBGT
VCGX, VCEX,
VCGT, VCET
- VBMW, VCMW

				Dimensões, mm								
	CZC _{MS}	DMIN ₁	RMPX	Código para pedido	DCON _{MS}	H	LF	WF			MIID	
	16	80	100.0	45°	570-SVLBR/L-80-16	80.0	37.5	45.7	57.0	3.0	0.49	VBMT 16 04 08



KAPR

95.0°

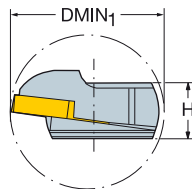
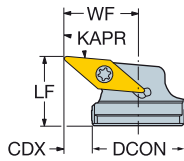

- VBMT, VBGT
VCGX, VCEX,
VCGT, VCET
- VBMW, VCMW

				Dimensões, mm								
	CZC _{MS}	DMIN ₁	RMPX	Código para pedido	DCON _{MS}	H	LF	WF			MIID	
	16	32	40.0	45°	SL-SVLBR-32-16-QC	32.0	14.7	22.0	24.0	3.0	0.08	VBMT 16 04 08

G R = versão direita, L = versão esquerda

Componentes				
Código para pedido	Parafuso da pastilha	Calço	Parafuso do calço	Parafuso de ajuste
SL-SVLBR-32-16-QC	5513 020-10	5638 031-01	5514 060-10	5680 049-01
570-SVLBR/L-80-16	5513 020-01	5322 270-01	5512 090-01	3214 020-311

Para a lista completa de componentes, acesse www.sandvik.coromant.com

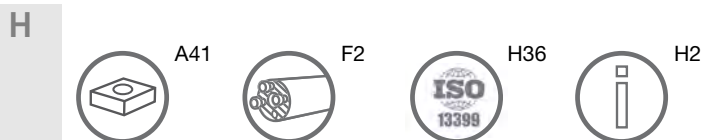

Cabeça CoroTurn® 107 para mandrilamento reverso

Fixação por parafuso

CoroTurn® SL - Refrigeração de precisão

KAPR

93.0°

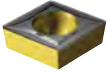

- CCMT, CCGT
CCGX, CCET
- CCMW

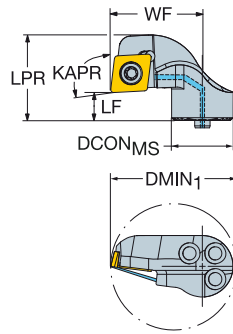

B

C

							Dimensões, mm							MIID
		CZC _{MS}	DMIN ₁	RMPX	CNSC	Código para pedido	DCON _{MS}	LPR	LF	WF	BAR	NM	KG	
	09	16	33.0	7°	1	SL-SCUCR-16-09-16X	16.0	22.0	7.0	24.0	70	3.0	0.05	CCMT 09 T3 08
		20	41.0	7°	1	SL-SCUCR-20-09-20X	20.0	22.0	7.0	30.0	70	3.0	0.07	CCMT 09 T3 08
		25	44.0	7°	1	SL-SCUCR-25-09-18X	25.0	24.0	7.0	30.5	70	3.0	0.08	CCMT 09 T3 08
		32	50.0	7°	1	SL-SCUCR-32-09-16X	32.0	24.0	8.0	32.0	70	3.0	0.12	CCMT 09 T3 08
		40	60.0	7°	1	SL-SCUCR-40-09-18X	40.0	24.0	8.0	38.0	70	3.0	0.18	CCMT 09 T3 08
	40	68.0	7°	1	SL-SCUCR-40-09-26X	40.0	24.0	8.0	46.0	70	3.0	0.21	CCMT 09 T3 08	

R = versão direita

D

		Componentes	
	CZC _{MS}	Parafuso da pastilha	Tubo de localização
09	16	5513 020-09	5552 058-01
09	20-25	5513 020-09	5552 058-02
09	32	5513 020-09	5638 031-01
09	40	5513 020-09	5638 031-01

Para a lista completa de componentes, acesse www.sandvik.coromant.com

E

F

G

H



Cabeça CoroTurn® 107 para mandrilamento reverso

Fixação por parafuso

CoroTurn® SL - Refrigeração de precisão

KAPR

93.0°

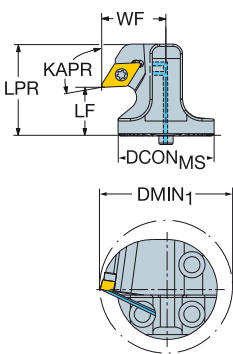

- DCMT, DCMX
DCGT, DCGX, DCET
- DCMW

D	CZC _{MS}	DMIN ₁	RMPX	CNSC	Código para pedido	Dimensões, mm						MIID		
						DCON _{MS}	LPR	LF	WF	BAR	NM		KG	
	11	32	40.0	27°	1	SL-SDUCR/L-32-11XHP	32.0	37.0	20.0	22.0	80	3.0	0.15	DCMT 11 T3 08
		40	50.0	27°	1	SL-SDUCR/L-40-11XHP	40.0	37.0	20.0	27.0	80	3.0	0.25	DCMT 11 T3 08
		07	25	33.0	27°	1	SL-SDUCR/L-25-07-DXHP	25.0	27.9	15.0	18.0	80	0.9	0.09

R = versão direita, L = versão esquerda

E	Componentes				
	Código para pedido	Parafuso da pastilha	Calço	Parafuso do calço	Olhal
	SL-SDUCR/L-25-07-DXHP	5513 020-03			
	SL-SDUCR/L-32-11XHP	5513 020-01	5322 263-01	5512 090-01	5691 026-13
	SL-SDUCR/L-40-11XHP	5513 020-01	5322 263-01	5512 090-01	5691 026-13

Para a lista completa de componentes, acesse www.sandvik.coromant.com



Cabeça CoroTurn® 107 para mandrilamento reverso

Fixação por parafuso

CoroTurn® SL Troca Rápida

KAPR

93.0°



- DCMT, DCMX
DCGT, DCGX, DCET
- DCMW

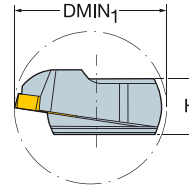
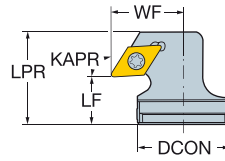

		Dimensões, mm											
		CZC _{MS}	DMIN ₁	RMPX	Código para pedido	DCON _{MS}	H	LPR	LF	WF			MIID
	11	32	40.0	27°	SL-SDUCR-32-11X-QC	32.0	14.7	30.0	15.0	24.0	3.0	0.10	DCMT 11 T3 08

R = versão direita, L = versão esquerda

Componentes			
Código para pedido	Parafuso	Tubo de localização	Parafuso de ajuste
SL-SDUCR-32-11X-QC	5513 020-10	5638 031-01	5514 060-10

Para a lista completa de componentes, acesse www.sandvik.coromant.com



Cabeça CoroTurn® 107 para mandrilamento reverso

Fixação por parafuso

CoroTurn® SL - Refrigeração interna

KAPR

93.0°

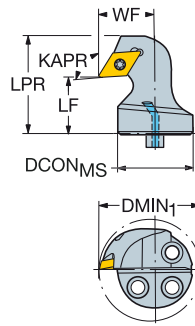

- DCMT, DCMX
DCGT, DCGX, DCET
- DCMW

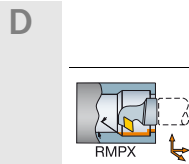

		Dimensões, mm												
		CZCMS	DMIN1	RMPX	CNSC	Código para pedido	DCONMS	LPR	LF	WF				MIID
	07	16	22.0	27°	1	570-SDUCR/L-16-07-EX	16.0	26.6	15.0	13.0	10	0.9	0.03	DCMT 07 02 04
		20	27.0	27°	1	570-SDUCR/L-20-07-EX	20.0	26.6	15.0	15.0	10	0.9	0.05	DCMT 07 02 04
		25	33.0	27°	1	570-SDUCR/L-25-07-DX	25.0	26.6	15.0	18.0	10	0.9	0.06	DCMT 07 02 04
	11	32	40.0	27°	1	570-SDUCR/L-32-11X	32.0	37.0	20.0	22.0	10	3.0	0.14	DCMT 11 T3 08
		40	50.0	27°	1	570-SDUCR/L-40-11X	40.0	37.0	20.0	27.0	10	3.0	0.22	DCMT 11 T3 08

R = versão direita, L = versão esquerda

Componentes					
	CZCMS	Parafuso da pastilha	Calço	Parafuso do calço	Tubo de localização
07	16	5513 020-03			5552 058-01
07	20-25	5513 020-03			5552 058-02
11	32-40	5513 020-01	5322 263-01	5512 090-01	5638 031-01

Para a lista completa de componentes, acesse www.sandvik.coromant.com



Cabeça CoroTurn® 107 para mandrilamento reverso

Fixação por parafuso

CoroTurn® SL Troca Rápida

KAPR

93.0°

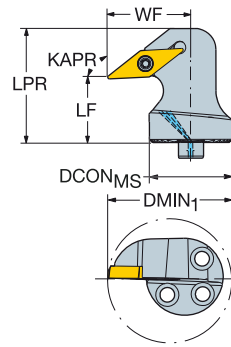

- VCMT, VCEX, VCGX
- VCMW

B

C

							Dimensões, mm								
		CZC _{MS}	DMIN ₁	RMPX	CNSC	Código para pedido	DCON _{MS}	LPR	LF	WF	BAR	NM	KG	MIID	
	11	20	32.0	30°	1	570-SVUCR/L-20-11X-E	20.0	27.0	15.0	20.0	10	0.9	0.05	VCMT 11 03 04	
		25	37.0	30°	1	570-SVUCR/L-25-11X-D	25.0	27.0	15.0	22.0	10	0.9	0.08	VCMT 11 03 04	

R = versão direita, L = versão esquerda

D

Componentes	
Parafuso da pastilha	Tubo de localização
5513 020-03	5552 058-02

Para a lista completa de componentes, acesse www.sandvik.coromant.com

E

F

G

H



Cabeça CoroTurn® 107 para mandrilamento reverso

Fixação por parafuso

CoroTurn® SL Troca Rápida

KAPR

95.0°

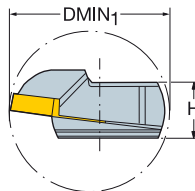
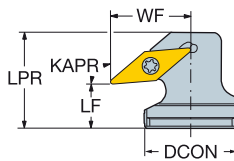

- VBMT, VBGT
VCGX, VCEX,
VCGT, VCET
- VBMT, VCMW

C

D

		Dimensões, mm											
		CZC _{MS}	DMIN ₁	RMPX	Código para pedido	DCON _{MS}	H	LPR	LF	WF	NM	KG	MIID
	16	32	40.0	45°	SL-SVLBR-32-16X-QC	32.0	14.7	31.0	14.0	26.0	3.0	0.10	VBMT 16 04 08

R = versão direita, L = versão esquerda

E

Componentes

Parafuso	Tubo de localização	Parafuso de ajuste
5513 020-10	5638 031-01	5514 060-10

Para a lista completa de componentes, acesse www.sandvik.coromant.com

F

G

H



T-Max® P

Otimizado para torneamento externo

Aplicação

- Torneamento longitudinal
- Faceamento
- Perfilamento
- Desbaste ao acabamento
- Torneamento interno de diâmetros grandes, a partir de 50 mm

Área de aplicação ISO:



Características e benefícios

- Solução produtiva com as tecnologias Wiper e Xcel
- Ferramentas que apresentam refrigeração de precisão para excelente quebra de cavacos
- Usinagem confiável e segura, mesmo em aplicações de desbaste
- Pastilhas dupla face com arestas robustas
- Fixação por alavanca para usinagem com refrigeração
- Fixação rígida para usinagem sem refrigeração e materiais com cavacos curtos
- Fixação por cunha para melhor acessibilidade

www.sandvik.coromant.com/tmaxp

Pastilhas

- Todos os tipos de formatos e tamanhos de pastilhas
- Geometrias e classes para todas as áreas de aplicação
- Classes de pastilhas também em materiais de corte avançados PCD, CBN e cerâmicas
- Pastilhas específicas para refrigeração de precisão

Ferramentas

- Unidades de corte Coromant Capto®
- Ferramentas convencionais
- Barras de mandril
- Cabeças CoroTurn® SL

Refrigeração de precisão

Os suportes estão disponíveis com olhais de precisão para excelente controle de cavacos.



Soluções de fixação diferentes

Fixação por alavanca

Fixação rígida

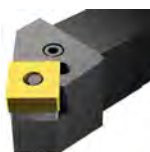

A152



A177



A217



H35

A

Pastilha T-Max® P para torneamento

Acabamento

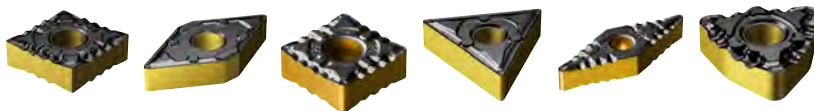

CN..	DN..	SN..	TN..	VN..	WN..
A153	A160	A166	A169	A172	A174

Página

Média

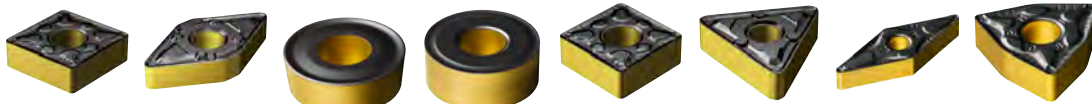

CN..	DN..	RC..	RN..	SN..	TN..	VN..	WN..
A153	A160	A165	A165	A166	A169	A172	A174

Página

Desbaste

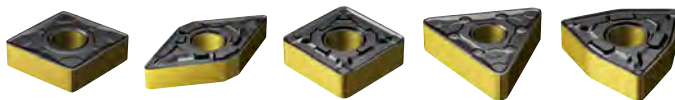

CN..	DN..	SN..	TN..	WN..
A153	A160	A166	A169	A174

Página

Materiais de corte avançados

Cerâmicas

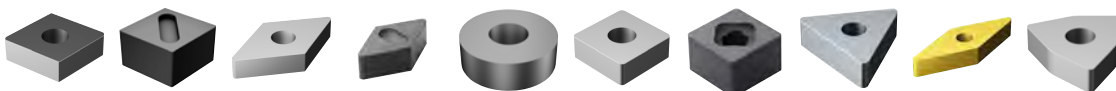

CN..	CNGX	DN..	DNGX	RN..	SN..	SNGQ	TN..	VN..	WN..
A157	A157	A163	A163	A165	A168	A168	A171	A173	A176

Página

Nitreto cúbico de boro (CBN)

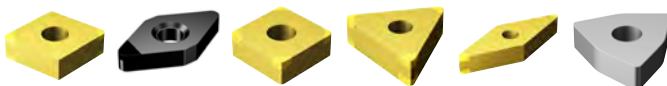

CN..	DN..	SN..	TN..	VN..	WN..
A157	A163	A168	A171	A173	A176

Página

G

H

Pastilha T-Max® P para torneamento

Pastilha tipo C (rômbica 80°)

Geometria para altos avanços

B

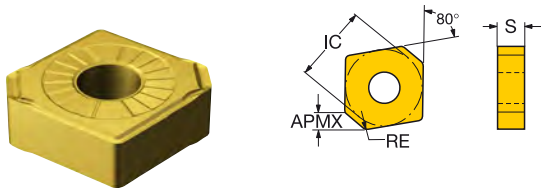

C

Desbaste	S	RE	APMX	KCH	CHW	CÓDIGO ISO	M		S		
							2015	1105	6160	H13A	S05F
12	4.76	0.8	1.5	50°	1.5	CNMX 12 04 A1-SM	★	★	★	★	★
4.76	0.8	2.5	50°	2.5		CNMX 12 04 A2-SM	★	★	★	★	★

D

Os suportes com pastilhas CNMX precisam ser modificados.

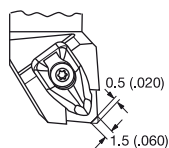

Calços
5322 234-07 para desenho de suportes T-Max P com
fixação tipo alavanca 5322 234-08 para suportes CoroTurn
RC

E

Materiais de corte avançados

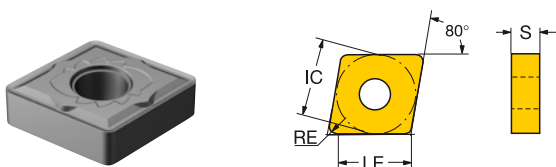

F

Média	LE	S	RE	CÓDIGO ISO	S	CÓDIGO ANSI
					6160	
12	8.5	4.76	0.79	CNMG 12 04 08-SM	★	CNMG 432-SM

G

H



Pastilha T-Max® P para torneamento

Pastilha tipo C (rômbica 80°)

Materiais de corte avançados

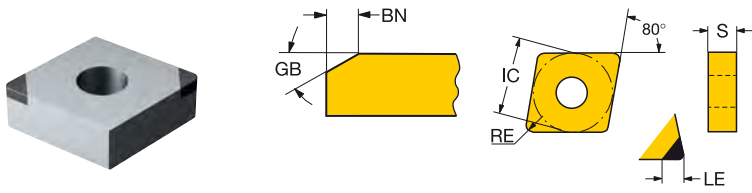

	LE	S	RE	BS	GB	BN	CÓDIGO ISO	H		CÓDIGO ANSI
								7125	7135	
Acabamento	12	2.6	4.76	0.40	30°	0.15	CNGA120404S01530F	★		CNGA431S0530F
	2.5	4.76	0.80		30°	0.15	CNGA120408S01530F	★		CNGA432S0530F
	2.5	4.76	0.80		35°	0.20	CNGA120408S02035F	★		CNGA432S0835F
	2.9	4.76	1.20		30°	0.15	CNGA120412S01530F	★		CNGA433S0530F
	2.4	4.76	1.20		35°	0.20	CNGA120412S02035F	★		CNGA433S0835F
	2.8	4.76	1.60		35°	0.20	CNGA120416S02035F	★		CNGA434S0835F
	2.5	4.76	0.80	0.6	20°	0.15	CNGA120408S01520FWH	★		CNGA432S0520FWH
	3.5	4.76	0.80		30°	0.12	CNGM120408F-HGR	★		CNGM432F-HGR
	3.5	4.76	1.20		30°	0.12	CNGM120412F-HGR	★		CNGM433F-HGR

Materiais de corte avançados - geometria Xcel

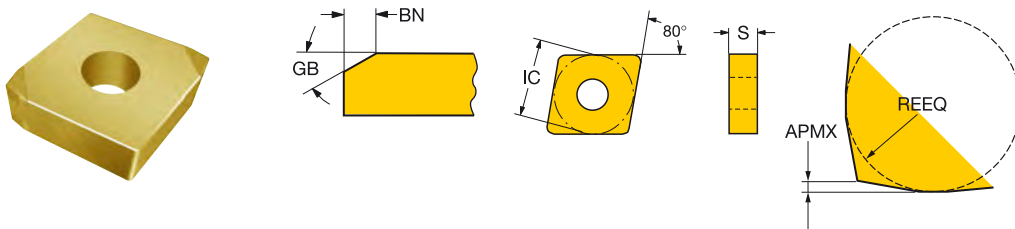

	LE	S	REEQ	RE	APMX	GB	BN	CÓDIGO ISO	H				
									7015	7025	7105	7115	7125
Acabamento	12	4.76	2.3	0.0	0.3	15°	0.15	CNGX1204L025-18AXA	☆	★			
	3.3	4.76	2.3	0.0	0.3	15°	0.15	CNGX1204L025-18HXA			☆	☆	★



A177



A217



A278



A294



H36



H6



H3

Pastilha T-Max® P para torneamento

Pastilha tipo D (rômbica 55°)

Materiais de corte avançados

B

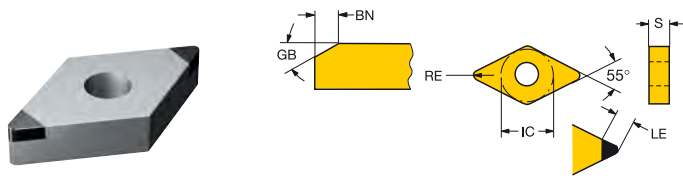

C

	LE	S	RE	GB	BN	CÓDIGO ISO	H		CÓDIGO ANSI
							7125	7135	
Acabamento	11	2.9	4.76	0.40	30°	0.15	DNGA110404S01530F	*	DNGA331S0530F
	2.5	4.76	0.80	30°	0.15	DNGA110408S01530F	*	DNGA332S0530F	
	15	2.5	4.76	0.80	30°	0.15	DNGA150408S01530F	*	DNGA432S0530F
	2.5	4.76	0.80	35°	0.20	DNGA150408S02035F	*	DNGA432S0835F	
	3.2	4.76	1.20	30°	0.15	DNGA150412S01530F	*	DNGA433S0530F	
	3.2	4.76	1.20	35°	0.20	DNGA150412S02035F	*	DNGA433S0835F	
	3.5	4.76	0.80	30°	0.12	DNGM150408F-HGR	*	DNGM432F-HGR	
	3.5	4.76	1.20	30°	0.12	DNGM150412F-HGR	*	DNGM433F-HGR	

D

E

F

G

H



Pastilha T-Max® P para torneamento

Pastilha tipo R (redonda)

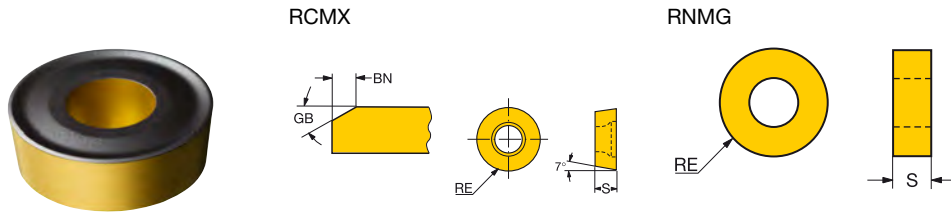

		S	RE	GB	BN	CÓDIGO ISO	P		M		K		N		S						
							4305	4315	4325	4335	1115	1125	3210	3225	4325	H13A	H13A	1105	1115	1125	H13A
Medium	00	10	3.18	5.00	15°	0.20	RCMX 10 03 00	☆	☆	★	☆										
		12	4.76	6.00	15°	0.20	RCMX 12 04 00	☆	☆	★	☆										
		16	6.35	8.00	15°	0.25	RCMX 16 06 00	☆	☆	★	☆										
		20	6.35	10.00	15°	0.30	RCMX 20 06 00	☆	☆	★	☆										
	E	10	3.18	5.00			RCMX 10 03 00E														★
		12	4.76	6.00			RCMX 12 04 00E														★
	00	09	3.18	4.76			RNMG 09 03 00			★	☆		★	☆							
		12	4.76	6.35			RNMG 12 04 00	☆	☆	★	☆		★	☆							
		15	6.35	7.94			RNMG 15 06 00	☆	☆	★	☆		★	☆							
		19	6.35	9.53			RNMG 19 06 00	☆	☆	★	☆		★	☆							
S	M	19	6.35	9.53		RNMG 19 06 00-SM				★	☆			★	☆	☆	☆	☆	☆		

Materiais de corte avançados

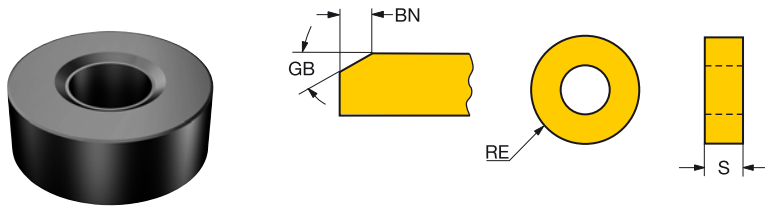

		S	RE	GB	BN	CÓDIGO ISO	K	S	H
							650	650	650
Acabamento	12	4.76	6.35	20°	0.10	RNGA120400T01020	★	★	★



Pastilha T-Max® P para torneamento

Pastilha tipo V (rômbica 35°)

Materiais de corte avançados

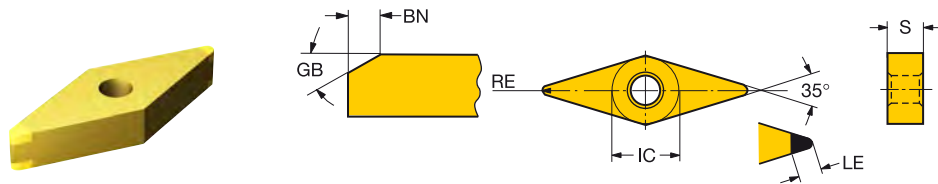

	LE	S	RE	GB	BN	CÓDIGO ISO	H							
							6050	7015	7025	7105	7115	7125		
Acabamento	16	2.1	4.76	0.4	20°	0.10	VNGA160404S01020A			★				
		4.4	4.76	0.4	30°	0.10	VNGA160404S01030A		☆	★				
		16.2	4.76	0.4	25°	0.15	VNGA160404S01525	★						
		2.5	4.76	0.4	25°	0.15	VNGA160404S01525H				☆	☆	★	
		2.4	4.76	0.8	20°	0.10	VNGA160408S01020A			★				
		3.5	4.76	0.8	30°	0.10	VNGA160408S01030A		☆	★				
		15.8	4.76	0.8	25°	0.15	VNGA160408S01525	★						
		2.5	4.76	0.8	25°	0.15	VNGA160408S01525H				☆	☆	★	
		2.4	4.76	0.8	35°	0.20	VNGA160408S02035A		☆	★				
		15.8	4.76	0.8	25°	0.15	VNGA160408T01525	★						
		15.4	4.76	1.2	25°	0.15	VNGA160412S01525	★						



A

Pastilha T-Max® P para torneamento

Pastilha tipo W (trigonal 80°)

Materiais de corte avançados

B

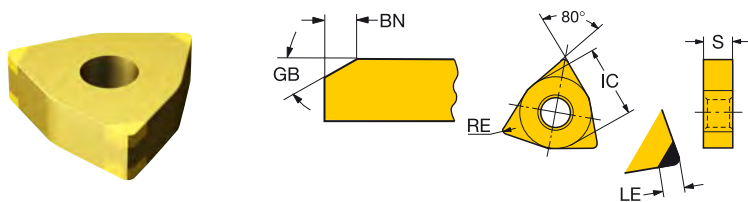

C

	LE	S	RE	BS	GB	BN	CÓDIGO ISO	K		H										
								6190	7525	6050	7015	7025	7105	7115	7125	7135	7525			
06	2.4	4.76	0.4		30°	0.10	WNGA060404S01030A													
	2.6	4.76	0.4		25°	0.15	WNGA060404S01525H													
	1.8	4.76	0.4		20°	0.10	WNGA060404T01020B			*									*	
	2.4	4.76	0.8		30°	0.10	WNGA060408S01030A					*								
	2.5	4.76	0.8		25°	0.15	WNGA060408S01525H							*						
	2.4	4.76	0.8		20°	0.10	WNGA060408T01020B			*									*	
	1.8	4.76	0.4	0.8	20°	0.10	WNGA060404T01020BWG			*									*	
	2.4	4.76	0.8	1.0	20°	0.10	WNGA060408T01020BWG			*									*	
	2.4	4.76	0.4	0.5	30°	0.10	WNGA060404S01030AWH					*								
	2.6	4.76	0.4	0.5	20°	0.15	WNGA060404S01520HWH						*							
	2.4	4.76	0.4	0.5	30°	0.10	WNGA060404T01030AWH				*									
	2.4	4.76	0.8	0.6	30°	0.10	WNGA060408S01030AWH				*									
	2.5	4.76	0.8	0.6	20°	0.15	WNGA060408S01520HWH					*								
	2.4	4.76	0.8	0.6	30°	0.10	WNGA060408T01030AWH				*									
	08	3.0	4.76	0.4		30°	0.10	WNGA080404S01030A				*								
		8.3	4.76	0.4		25°	0.15	WNGA080404S01525H			*									
		2.6	4.76	0.4		25°	0.15	WNGA080404S01525H					*							
		3.1	4.76	0.4		20°	0.10	WNGA080404T01020B			*									*
2.9		4.76	0.8		30°	0.10	WNGA080408S01030A				*									
7.9		4.76	0.8		25°	0.15	WNGA080408S01525H			*										
2.5		4.76	0.8		25°	0.15	WNGA080408S01525H					*		*						
2.5		4.76	0.8		30°	0.15	WNGA080408S01530F										*			
2.0		4.76	0.8		35°	0.20	WNGA080408S02035A				*									
3.0		4.76	0.8		20°	0.10	WNGA080408T01020B			*									*	
7.9		4.76	0.8		25°	0.15	WNGA080408T01525H			*										
7.9		4.76	0.8		20°	0.25	WNGA080408T02520			*										
2.8		4.76	1.2		30°	0.10	WNGA080412S01030A				*									
2.4		4.76	1.2		25°	0.15	WNGA080412S01525H				*		*		*					
2.9		4.76	1.2		30°	0.15	WNGA080412S01530F										*			
2.9		4.76	1.2		20°	0.10	WNGA080412T01020B			*									*	
7.5		4.76	1.2		20°	0.25	WNGA080412T02520			*										
7.1		4.76	1.6		20°	0.25	WNGA080416T02520			*										
3.1		4.76	0.4	0.8	20°	0.10	WNGA080404T01020BWG			*									*	
3.0		4.76	0.8	1.0	20°	0.10	WNGA080408T01020BWG			*									*	
7.9		4.76	0.8	1.0	20°	0.10	WNGA080408T01020WG			*										
7.5		4.76	1.2	1.2	20°	0.10	WNGA080412T01020WG			*										
3.0		4.76	0.4	0.5	30°	0.10	WNGA080404S01030AWH					*								
2.6		4.76	0.4	0.5	20°	0.15	WNGA080404S01520HWH					*		*						
8.3	4.76	0.4	0.5	25°	0.15	WNGA080404S01525WH			*				*							
3.0	4.76	0.4	0.5	30°	0.10	WNGA080404T01030AWH				*										
2.9	4.76	0.8	0.6	30°	0.10	WNGA080408S01030AWH				*										
2.5	4.76	0.8	0.6	20°	0.15	WNGA080408S01520HWH					*		*							
7.9	4.76	0.8	0.6	25°	0.15	WNGA080408S01525WH			*											
2.9	4.76	0.8	0.6	30°	0.10	WNGA080408T01030AWH			*											
7.9	4.76	0.8	0.6	25°	0.15	WNGA080408T01525WH			*											
2.8	4.76	1.2	0.6	30°	0.10	WNGA080412S01030AWH				*										
2.4	4.76	1.2	0.6	20°	0.15	WNGA080412S01520HWH				*		*								
2.8	4.76	1.2	0.6	30°	0.10	WNGA080412T01030AWH			*											

G

H



Ferramentas T-Max® P para usinagem externa

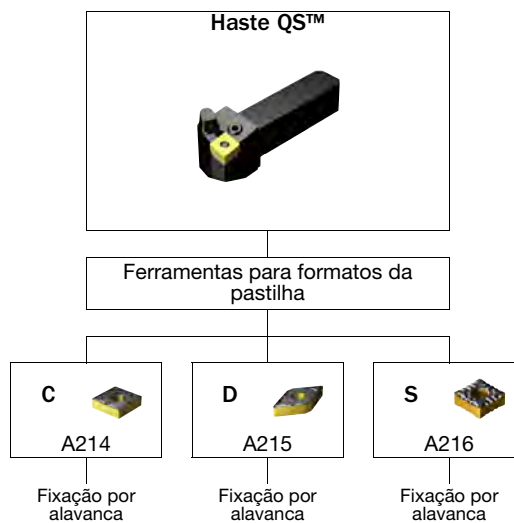

A

TORNEAMENTO GERAL

Ferramentas externas

Unidade de corte T-Max® P para torneamento

Fixação por alavanca

Coromant Capto® - Refrigeração de precisão

B

KAPR

Cx-PCMNN..HP (M-T)
50.0°

Cx-PCLNR/L..HP (M-T)
95.0°

C

CNMM
 CNMG
 CNMA, CNGA

Ferramentas para usinagem multitarefas

D

CZC _{MS}	DMIN ₁	DMIN ₂	CNSC	Código para pedido	Dimensões, mm						MIID
					DCON _{MS}	LF	WF	BAR	NM	KG	
12	C6	110.0	3	C6-PCLNR/L-45165-12HP	63.0	165.0	45.0	150	5.0	3.70	CNMG 12 04 08
12	C4	185.0	3	C4-PCMNN-00095-12HP	40.0	95.0	0.0	150	5.0	0.76	CNMG 12 04 08
	C5	220.0	3	C5-PCMNN-00115-12HP	50.0	115.0	0.0	150	5.0	1.38	CNMG 12 04 08
	C6	240.0	3	C6-PCMNN-00115-12HP	63.0	115.0	0.0	150	5.0	1.98	CNMG 12 04 08
	C8	315.0	3	C8-PCMNN-00150-12HP	80.0	150.0	0.0	150	5.0	4.14	CNMG 12 04 08
	C10	315.0	3	C10-PCMNN-00110-19HP	100.0	110.0	0.0	150	10.0	5.78	CNMG 19 06 12

N = neutra, R = versão direita, L = versão esquerda

E

Componentes						
CZC _{MS}	Alavanca	Parafuso	Calço	Rebite elástico	Olhal	
12	C4-C8	174.3-841M	174.3-821	171.31-850M	174.3-861	5691 026-03
19	C10	174.3-842M	174.3-822M	171.35-851M	174.3-862	5691 026-03

Para a lista completa de componentes, acesse www.sandvik.coromant.com

F

G

H

A 178

POR

Unidade de corte T-Max® P para torneamento

Fixação por alavanca

Coromant Capto® - Refrigeração de precisão



-  CNMM
-  CNMG
-  CNMA, CNGA

KAPR

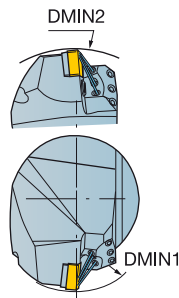

95.0°

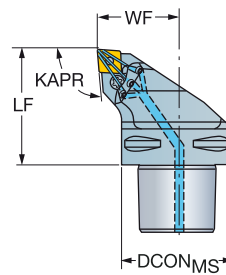

CZC _{MS}	C	DMIN ₁	DMIN ₂	CNSC	Código para pedido	Dimensões, mm						MIID
						DCON _{MS}	LF	WF	BAR	NM	KG	
12	C4	110.0	140.0	3	C4-PCLNR/L-27050-12HP	40.0	50.0	27.0	150	5.0	0.47	CNMG 12 04 08
	C5	110.0	165.0	3	C5-PCLNR/L-35060-12HP	50.0	60.0	35.0	150	5.0	0.79	CNMG 12 04 08
	C6	110.0	195.0	3	C6-PCLNR/L-45065-12HP	63.0	65.0	45.0	150	5.0	1.36	CNMG 12 04 08
	C8	110.0	250.0	3	C8-PCLNR/L-55080-12HP	80.0	80.0	55.0	150	5.0	2.67	CNMG 12 04 08
16	C5	125.0	165.0	3	C5-PCLNR/L-35060-16HP	50.0	60.0	35.0	150	5.0	0.85	CNMG 16 06 12
	C6	110.0	195.0	3	C6-PCLNR/L-45065-16HP	63.0	65.0	45.0	150	5.0	1.36	CNMG 16 06 12
	C8	125.0	250.0	3	C8-PCLNR/L-55080-16HP	80.0	80.0	55.0	150	5.0	2.72	CNMG 16 06 12
19	C6	110.0	195.0	3	C6-PCLNR/L-45065-19HP	63.0	65.0	45.0	150	10.0	1.38	CNMG 19 06 12
	C8	150.0	250.0	3	C8-PCLNR/L-55080-19HP	80.0	80.0	55.0	150	10.0	2.69	CNMG 19 06 12
	C10	220.0	315.0	3	C10-PCLNR/L-68110-19HP	100.0	110.0	68.0	150	10.0	6.60	CNMG 19 06 12

R = versão direita, L = versão esquerda

Componentes						
CZC _{MS}	C	Alavanca	Parafuso	Calço	Rebite elástico	Olhal
12	C4-C8	174.3-841M	174.3-821	171.31-850M	174.3-861	5691 026-03
16	C5-C8	438.3-840	438.3-831	171.31-852	174.3-864	5691 026-03
19	C6-C10	174.3-842M	174.3-822M	171.31-851M	174.3-862	5691 026-03

Para a lista completa de componentes, acesse www.sandvik.coromant.com



A

Unidade de corte T-Max® P para torneamento

Fixação rígida

Coromant Capto® - Refrigeração interna

B



KAPR

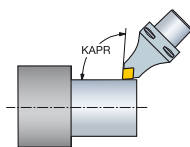

95.0°

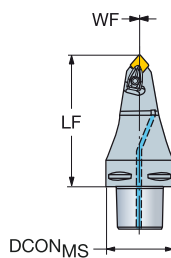

C

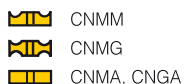

Ferramentas para usinagem multitarefas

D

Código para pedido	CZC _{MS}	CNSC	Dimensões, mm	Dimensões, mm			MIID		
				DCON _{MS}	LF	WF	BAR	NM	KG
C5-DCMNN-00105-12	C5	3	50.0	105.0	0.0	10	3.9	1.14	CNMG 12 04 08
			63.0	90.0	0.0	10	3.9	1.39	CNMG 12 04 08
			63.0	115.0	0.0	10	3.9	1.84	CNMG 12 04 08
C6-DCMNN-00090-16	C6	3	63.0	90.0	0.0	10	6.4	1.32	CNMG 16 06 12
			80.0	150.0	0.0	10	6.4	4.00	CNMG 16 06 12

N = neutra

E

Componentes					
CZC _{MS}	Parafuso do calço	Calço	Jogo de fixação	Olhal	
12	C5	5513 020-02	5322 234-01	5412 028-021	5691 034-02
12	C6	5513 020-02	5322 234-01	5412 028-021	5691 034-03
16	C6-C8	5513 020-07	5322 234-03	5412 028-031	5691 034-03

Para a lista completa de componentes, acesse www.sandvik.coromant.com

F

G

H



A152



F2



E1



G1



H36



H10



H5

Unidade de corte T-Max® P para torneamento

Fixação rígida

Coromant Capto® - Refrigeração interna



- CNMM
- CNMG
- CNMA, CNGA

KAPR

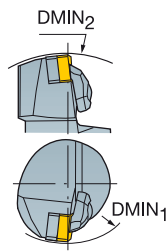

95.0°

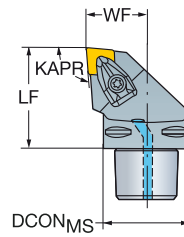

CZC _{MS}	C	DMIN ₁	DMIN ₂	CNSC	Código para pedido	Dimensões, mm						MIID
						DCON _{MS}	LF	WF	BAR	NM	KG	
09	C4	60.0	140.0	3	C4-DCLNR/L-27050-09	40.0	50.0	27.0	10	1.7	0.41	CNMG 09 03 08
12	C3	60.0	121.0	3	C3-DCLNR/L-22045-12	32.0	45.0	22.0	10	3.9	0.26	CNMG 12 04 08
	C4	110.0	140.0	3	C4-DCLNR/L-27050-12	40.0	50.0	27.0	10	3.9	0.44	CNMG 12 04 08
	C5	110.0	165.0	3	C5-DCLNR/L-35060-12	50.0	60.0	35.0	10	3.9	0.79	CNMG 12 04 08
	C6	110.0	190.0	3	C6-DCLNR/L-45065-12	63.0	65.0	45.0	10	3.9	1.33	CNMG 12 04 08
	C8	110.0	250.0	3	C8-DCLNR/L-55080-12	80.0	80.0	55.0	10	3.9	2.56	CNMG 12 04 08
16	C4	125.0	145.0	3	C4-DCLNR/L-27055-16	40.0	55.0	27.0	10	6.4	0.48	CNMG 16 06 12
	C5	125.0	165.0	3	C5-DCLNR/L-35060-16	50.0	60.0	35.0	10	6.4	0.79	CNMG 16 06 12
	C6	125.0	190.0	3	C6-DCLNR/L-45065-16	63.0	65.0	45.0	10	6.4	1.43	CNMG 16 06 12
	C8	125.0	250.0	3	C8-DCLNR/L-55080-16	80.0	80.0	55.0	10	6.4	2.59	CNMG 16 06 12
19	C5	80.0	165.0	3	C5-DCLNR/L-35060-19	50.0	60.0	35.0	10	6.4	0.87	CNMG 19 06 12
	C6	81.0	190.0	3	C6-DCLNR/L-45065-19	63.0	65.0	45.0	10	6.4	1.34	CNMG 19 06 12
	C8	100.0	250.0	3	C8-DCLNR/L-55080-19	80.0	80.0	55.0	10	6.4	2.61	CNMG 19 06 12

R = versão direita, L = versão esquerda

Componentes					
CZC _{MS}	C	Parafuso do calço	Calço	Jogo de fixação	Olhal
09	C4	5513 020-04	5322 236-04	5412 028-011	5691 045-01
12	C3	5513 020-02	5322 236-03	5412 028-021	
12	C4-C8	5513 020-02	5322 234-01	5412 028-021	5691 045-01
16	C4-C8	5513 020-07	5322 234-03	5412 028-031	5691 045-01
19	C5-C8	5513 020-07	5322 236-01	5412 028-041	5691 045-01

Para a lista completa de componentes, acesse www.sandvik.coromant.com



A

Unidade de corte T-Max® P para torneamento

Fixação rígida

Coromant Capto® - Refrigeração interna

B



KAPR

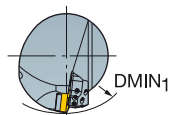

75.0°

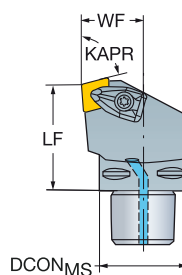

C



D

CZC _{MS}	C4	DMIN ₁	CNSC	Código para pedido	Dimensões, mm							MIID
					DCON _{MS}	LPR	LF	WF	BAR	NM	KG	
12	C4	110.0	3	C4-DCKNR/L-27050-12	40.0	53.1	50.0	27.0	10	3.9	0.49	CNMG 12 04 08
	C5	110.0	3	C5-DCKNR/L-35060-12	50.0	63.1	60.0	35.0	10	3.9	0.89	CNMG 12 04 08
	C6	110.0	3	C6-DCKNR/L-45065-12	63.0	68.1	65.0	45.0	10	3.9	1.48	CNMG 12 04 08
16	C5	125.0	3	C5-DCKNR/L-35060-16	50.0	63.8	60.0	35.0	10	6.4	0.86	CNMG 16 06 12
	C6	125.0	3	C6-DCKNR/L-45065-16	63.0	68.8	65.0	45.0	10	6.4	1.50	CNMG 16 06 12
19	C6	81.0	3	C6-DCKNR/L-45065-19	63.0	74.6	65.0	45.0	10	6.4	1.50	CNMG 19 06 12
	C8	100.0	3	C8-DCKNR/L-55080-19	80.0	89.6	80.0	55.0	10	6.4	2.82	CNMG 19 06 12

R = versão direita, L = versão esquerda

E

Componentes					
CZC _{MS}	Parafuso do calço	Calço	Jogo de fixação	Olhal	
12	C4	5513 020-02	5322 234-01	5412 028-021	5691 034-01
12	C5-C6	5513 020-02	5322 234-01	5412 028-021	5691 034-02
16	C5-C6	5513 020-07	5322 234-03	5412 028-031	5691 034-02
19	C6	5513 020-07	5322 236-01	5412 028-041	5691 034-02
19	C8	5513 020-07	5322 236-01	5412 028-041	5691 034-03

Para a lista completa de componentes, acesse www.sandvik.coromant.com

F

G

H



A152



F2



E1



G1



H36



H10



H5

Unidade de corte T-Max® P para torneamento

Fixação rígida

Coromant Capto® - Refrigeração interna



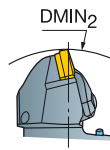

KAPR

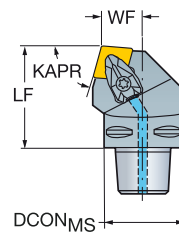

75.0°

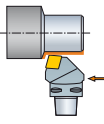

-  CNMM
-  CNMG
-  CNMA, CNGA

						Dimensões, mm							MIID
		CZC _{MS}	DMIN ₂	CNSC	Código para pedido	DCON _{MS}	LF	WF	BAR	NM	KG		
	12	C4	140.0	3	C4-DCRNR/L-22050-12	40.0	50.0	22.0	10	3.9	0.46	CNMG 12 04 08	
		C5	165.0	3	C5-DCRNR/L-27060-12	50.0	60.0	27.0	10	3.9	0.75	CNMG 12 04 08	
		C6	190.0	3	C6-DCRNR/L-35065-12	63.0	65.0	35.0	10	3.9	1.40	CNMG 12 04 08	
	16	C5	165.0	3	C5-DCRNR/L-27060-16	50.0	60.0	27.0	10	6.4	0.74	CNMG 16 06 12	
		C6	190.0	3	C6-DCRNR/L-35065-16	63.0	65.0	35.0	10	6.4	1.34	CNMG 16 06 12	
		C8	250.0	3	C8-DCRNR/L-55080-16	80.0	80.0	55.0	10	6.4	2.68	CNMG 16 06 12	
19	C6	190.0	3	C6-DCRNR/L-35065-19	63.0	65.0	35.0	10	6.4	1.33	CNMG 19 06 12		
	C8	250.0	3	C8-DCRNR/L-55080-19	80.0	80.0	55.0	10	6.4	2.68	CNMG 19 06 12		

R = versão direita, L = versão esquerda

Componentes					
	CZC _{MS}	Parafuso do calço	Calço	Jogo de fixação	Olhal
12	C4	5513 020-02	5322 234-01	5412 028-021	5691 034-01
12	C5-C6	5513 020-02	5322 234-01	5412 028-021	5691 045-01
16	C5-C8	5513 020-07	5322 234-03	5412 028-031	5691 045-01
19	C6-C8	5513 020-07	5322 236-01	5412 028-041	5691 045-01

Para a lista completa de componentes, acesse www.sandvik.coromant.com



A

TORNEAMENTO GERAL

Ferramentas externas

Unidade de corte T-Max® P para torneamento

Fixação por alavanca

Coromant Capto® - Refrigeração de precisão

B

KAPR

C_x-PDMNR/L...HP
48.0°C_x-PDJNR/L...HP (M-T)
93.0°

C

Ferramentas para usinagem multitarefas

D

	CZC _{MS}	RMPX	CNCS	Código para pedido	Dimensões, mm						MIID	
					DCON _{MS}	LF	WF	BAR	NM	KG		
	15	C6	27°	3	C6-PDJNR/L-45165-15HP	63.0	165.0	45.0	150	5.0	3.88	DNMG 15 06 08
	15	C6	27°	3	C6-PDMNR/L-00130-15HP	63.0	130.0	0.6	150	5.0	2.08	DNMG 15 06 08

E

R = versão direita, L = versão esquerda

Componentes

Alavanca	Parafuso	Calço	Rebite elástico	Olhal
174.3-847M	174.3-830	171.35-851M	174.3-861	5691 026-03

F

Para a lista completa de componentes, acesse www.sandvik.coromant.com

G

H

A152

F2

E1

G1

H36

H10

H5

A 184

Unidade de corte T-Max® P para torneamento

Fixação por alavanca

Coromant Capto® - Refrigeração de precisão



- DNMM, DNMX
- DNMG
- DNMA, DNGA

KAPR

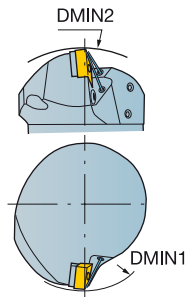

Cx-PDJNR/L..HP
93.0°

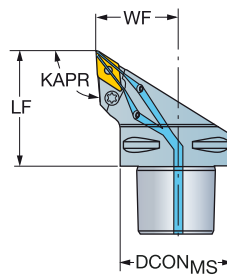

Cx-PDUNR/L..HP
93.0°

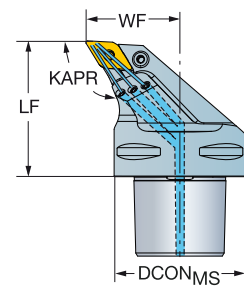

	CZC _{MS}	DMIN ₁	DMIN ₂	RMPX	CNSC	Código para pedido	Dimensões, mm						MIID	
							DCON _{MS}	LF	WF	BAR	NM	KG		
	11	C4	90.0	145.0	27°	3	C4-PDJNR/L-27050-11HP	40.0	50.0	27.0	150	2.0	0.44	DNMG 11 04 08
		C5	110.0	165.0	27°	3	C5-PDJNR/L-35060-11HP	50.0	60.0	35.0	150	2.0	0.79	DNMG 11 04 08
	15	C4	65.0	145.0	27°	3	C4-PDJNR/L-27055-15HP	40.0	55.0	27.0	150	5.0	0.48	DNMG 15 06 08
		C5	65.0	165.0	27°	3	C5-PDJNR/L-35060-15HP	50.0	60.0	35.0	150	5.0	0.79	DNMG 15 06 08
		C6	95.0	195.0	27°	3	C6-PDJNR/L-45065-15HP	63.0	65.0	45.0	150	5.0	1.31	DNMG 15 06 08
	15	C8	130.0	250.0	27°	3	C8-PDJNR/L-55080-15HP	80.0	80.0	55.0	150	5.0	2.74	DNMG 15 06 08
		C10	180.0	280.0	27°	3	C10-PDJNR/L-68110-15HP	100.0	110.0	68.0	150	5.0	6.05	DNMG 15 06 08
	15	C6	80.0	80.0	27°	3	C6-PDUNR/L-45065-15HP	63.0	65.0	45.0	150	5.0	1.36	DNMG 15 06 08
		C8	100.0	100.0	27°	3	C8-PDUNR/L-55080-15HP	80.0	80.0	55.0	150	5.0	2.77	DNMG 15 06 08

R = versão direita, L = versão esquerda

Componentes						
	CZC _{MS}	Alavanca	Parafuso	Calço	Rebite elástico	Olhal
11	C4-C5	5432 001-01	174.3-820M	5322 255-01	174.3-860	5691 026-03
15	C4-C5	174.3-847M	174.3-830	171.35-850M	174.3-861	5691 026-03
15	C6-C10	174.3-847M	174.3-830	171.35-851M	174.3-861	5691 026-03

Para a lista completa de componentes, acesse www.sandvik.coromant.com



A

Unidade de corte T-Max® P para torneamento

Fixação rígida

Coromant Capto® - Refrigeração interna

B



KAPR

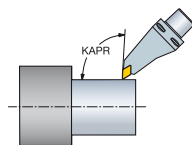

93.0°

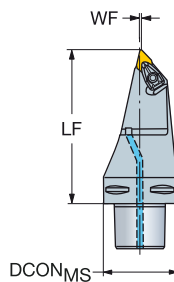

C

- DNMM, DNMX
- DNMG
- DNMA, DNGA

Ferramentas para usinagem multitarefas

D

	CZC _{MS}	RMPX	CNCS	Código para pedido	Dimensões, mm						MIID	
					DCON _{MS}	LF	WF	BAR	NM	KG		
	15	C5	27°	3	C5-DDMNL-00115-15	50.0	115.0	1.0	10	3.9	1.24	DNMG 15 06 08
		C6	27°	3	C6-DDMNL-00130-15	63.0	130.0	1.0	10	3.9	2.05	DNMG 15 06 08
		C8	27°	3	C8-DDMNL-00160-15	80.0	160.0	1.0	10	3.9	4.13	DNMG 15 06 08
		C6	27°	3	C6-DDMNL-33120-15	63.0	120.0	33.0	10	3.9	2.12	DNMG 15 06 08

L = versão esquerda

E

Componentes						
	CZC _{MS}	Parafuso do calço	Calço	Jogo de fixação	Olhal	
	15	C5	5513 020-02	5322 266-02	5412 028-021	5691 034-02
	15	C6-C8	5513 020-02	5322 266-02	5412 028-021	5691 034-03

Para a lista completa de componentes, acesse www.sandvik.coromant.com

F

G

H



A152



F2



E1



G1



H36



H10



H5

Unidade de corte T-Max® P para torneamento

Fixação rígida

Coromant Capto® - Refrigeração interna



- DNMM, DNMX
- DNMG
- DNMA, DNGA

KAPR

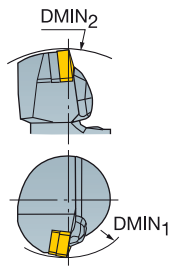

Cx-DDUNR/L
93.0°

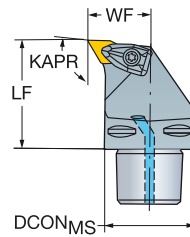

Cx-DDNNN
62.5°

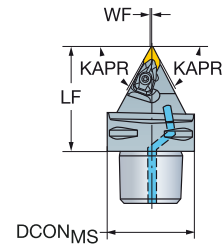

	CZC _{MS}	DMIN ₁	DMIN ₂	RMPX	CNCS	Código para pedido	Dimensões, mm						MIID	
							DCON _{MS}	LF	WF	BAR	NM	KG		
	11	C4	140.0	57°	3	C4-DDNNN-00050-11	40.0	50.0	0.5	10	1.7	0.35	DNMG 11 04 08	
	15	C4	145.0	57°	3	C4-DDNNN-00055-15	40.0	55.0	0.5	10	3.9	0.38	DNMG 15 06 08	
		C5	165.0	57°	3	C5-DDNNN-00060-15	50.0	60.0	0.5	10	3.9	0.62	DNMG 15 06 08	
		C6	190.0	57°	3	C6-DDNNN-00065-15	63.0	65.0	0.5	10	3.9	1.06	DNMG 15 06 08	
		C8	250.0	57°	3	C8-DDNNN-00080-15	80.0	80.0	0.5	10	3.9	2.10	DNMG 15 06 08	
	15	C4	110.0	140.0	27°	3	C4-DDUNR/L-27050-15	40.0	50.0	27.0	10	3.9	0.45	DNMG 15 06 08
		C5	110.0	165.0	27°	3	C5-DDUNR/L-35060-15	50.0	60.0	35.0	10	3.9	0.80	DNMG 15 06 08
		C6	110.0	190.0	27°	3	C6-DDUNR/L-45065-15	63.0	65.0	45.0	10	3.9	1.39	DNMG 15 06 08
		C8	110.0	250.0	27°	3	C8-DDUNR/L-55080-15	80.0	80.0	55.0	10	3.9	2.70	DNMG 15 06 08

N = neutra, R = versão direita, L = versão esquerda

Componentes					
	CZC _{MS}	Parafuso do calço	Calço	Jogo de fixação	Olhal
11	C4	5513 020-04	5322 267-01	5412 028-011	5691 034-01
15	C4	5513 020-02	5322 266-02	5412 028-021	5691 034-01
15	C5-C6	5513 020-02	5322 266-02	5412 028-021	5691 034-02
15	C8	5513 020-02	5322 266-02	5412 028-021	5691 034-03

Para a lista completa de componentes, acesse www.sandvik.coromant.com



A152



F2



E1



G1



H36



H10



H5



Unidade de corte T-Max® P para torneamento

Fixação rígida

Coromant Capto® - Refrigeração interna

B

KAPR

Cx-DDJNR/L
93.0°

Cx-DDHNR/L
107.5°

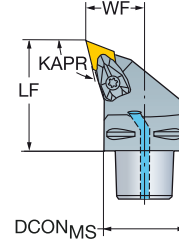
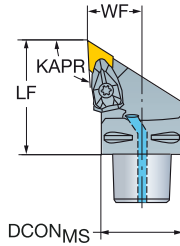
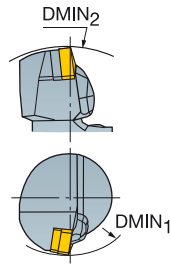

C

- DNMM, DNMX
- DNMG
- DNMA, DNGA

D

CZC _{MS}	C	DMIN ₁	DMIN ₂	RMPX	CNSC	Código para pedido	Dimensões, mm						MIID
							DCON _{MS}	LF	WF	BAR	NM	KG	
15	C4	110.0	145.0	12°	3	C4-DDHNR/L-27055-15	40.0	55.0	27.0	10	3.9	0.45	DNMG 15 06 08
	C5	110.0	165.0	12°	3	C5-DDHNR/L-35060-15	50.0	60.0	35.0	10	3.9	0.74	DNMG 15 06 08
	C6	110.0	190.0	12°	3	C6-DDHNR/L-45065-15	63.0	65.0	45.0	10	3.9	1.27	DNMG 15 06 08
	C8	110.0	250.0	12°	3	C8-DDHNR/L-55080-15	80.0	80.0	55.0	10	3.9	2.50	DNMG 15 06 08
11	C3	60.0	121.0	27°	3	C3-DDJNR/L-22045-11	32.0	45.0	22.0	10	1.7	0.23	DNMG 11 04 08
	C4	60.0	140.0	27°	3	C4-DDJNR/L-27050-11	40.0	50.0	27.0	10	1.7	0.39	DNMG 11 04 08
	C5	65.0	165.0	27°	3	C5-DDJNR/L-35060-11	50.0	60.0	35.0	10	1.7	0.76	DNMG 11 04 08
	15	C4	110.0	145.0	27°	3	C4-DDJNR/L-27055-15	40.0	55.0	27.0	10	3.9	0.46
C5		110.0	165.0	27°	3	C5-DDJNR/L-35060-15	50.0	60.0	35.0	10	3.9	0.72	DNMG 15 06 08
C6		110.0	190.0	27°	3	C6-DDJNR/L-45065-15	63.0	65.0	45.0	10	3.9	1.18	DNMG 15 06 08
C8		110.0	250.0	27°	3	C8-DDJNR/L-55080-15	80.0	80.0	55.0	10	3.9	2.30	DNMG 15 06 08

R = versão direita, L = versão esquerda

E

F

CZC _{MS}	C	Componentes			
		Parafuso do calço	Calço	Jogo de fixação	Olhal
11	C3	5513 020-04	5322 267-01	5412 028-011	
11	C4	5513 020-04	5322 267-01	5412 028-011	5691 034-01
11	C5	5513 020-04	5322 267-01	5412 028-011	5691 034-02
15	C4	5513 020-02	5322 266-02	5412 028-021	5691 034-01
15	C5	5513 020-02	5322 266-02	5412 028-021	5691 045-01
15	C6	5513 020-02	5322 266-02	5412 028-021	5691 034-02
15	C8	5513 020-02	5322 266-02	5412 028-021	5691 034-03

Para a lista completa de componentes, acesse www.sandvik.coromant.com

G

H



Unidade de corte T-Max® P para torneamento

Fixação por alavanca

Coromant Capto® - Refrigeração interna



RCMX
RCMT
RCGX AL

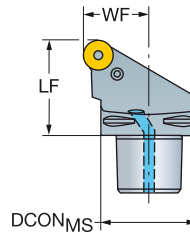

B

C

						Dimensões, mm						
		CZC _{MS}	RMPX	CNSC	Código para pedido	DCON _{MS}	LF	WF	BAR	NM	KG	MIID
	20	C8	27°	3	C8-PRSCR/L-55080-20	80.0	80.0	55.0	10	8.0	2.45	RCMX 20 06 00

D

R = versão direita, L = versão esquerda

Componentes				
Alavanca	Parafuso	Calço	Rebite elástico	Olhal
176.39-843	174.3-825	176.39-853	174.3-864	5691 034-03

Para a lista completa de componentes, acesse www.sandvik.coromant.com

E

F

G

H



A

Unidade de corte T-Max® P para torneamento

Fixação rígida

Coromant Capto® - Refrigeração interna

B

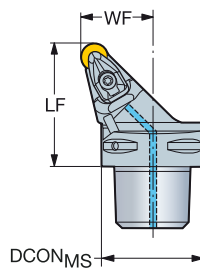
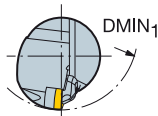
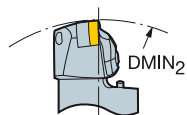

C



D

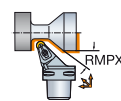

CZC _{MS}	C4	DMIN ₁	DMIN ₂	RMPX	CNCS	Código para pedido	Dimensões, mm						MIID
							DCON _{MS}	LF	WF	BAR	NM	KG	
12	C4	110.0	140.0	40°	3	C4-DRSNR/L-27050-12	40.0	50.0	27.0	10	3.9	0.38	RNMG 12 04 00
	C5	110.0	165.0	40°	3	C5-DRSNR/L-35060-12	50.0	60.0	35.0	10	3.9	0.70	RNMG 12 04 00
	C6	110.0	190.0	40°	3	C6-DRSNR/L-45065-12	63.0	65.0	45.0	10	3.9	1.11	RNMG 12 04 00

R = versão direita, L = versão esquerda

E

Componentes					
CZC _{MS}	Parafuso do calço	Calço	Jogo de fixação	Olhal	
12	C4	5513 020-02	5322 155-02	5412 028-021	5691 034-01
12	C5-C6	5513 020-02	5322 155-02	5412 028-021	5691 045-01

Para a lista completa de componentes, acesse www.sandvik.coromant.com

F

G

H



A152



F2



E1



G1



H36



H10



H5

Unidade de corte T-Max® P para torneamento





Fixação por alavanca

Coromant Capto® - Refrigeração de precisão

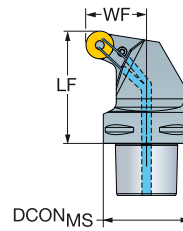
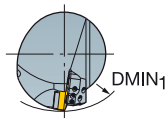

 RCMX
RCMT
RCGX AL



							Dimensões, mm							
			CZC _{MS}	DMIN ₁	RMPX	CNSC	Código para pedido	DCON _{MS}	LF	WF				MIID
	16	C10	500.0	65°	3	C10-PRSCR/L-70130-16C	100.0	130.0	70.0	150	5.0	6.84	RCMX 16 06 00	

R = versão direita, L = versão esquerda

Componentes				
Alavanca	Parafuso	Calço	Rebite elástico	Olhal
176.39-842	174.3-833	176.39-852	174.3-867	5691 026-03

Para a lista completa de componentes, acesse www.sandvik.coromant.com



Unidade de corte T-Max® P para torneamento

Fixação por alavanca

Coromant Capto® - Refrigeração de precisão

B



KAPR

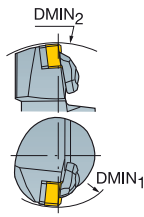

Cx-PSDNN..HP
45.0°

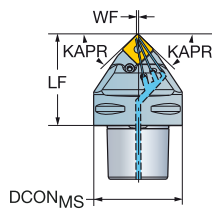

Cx-PSKNR/L..HP
75.0°

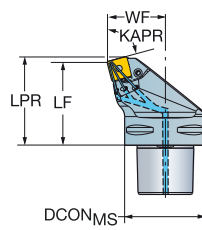

Cx-PSRNR/L..HP
75.0°

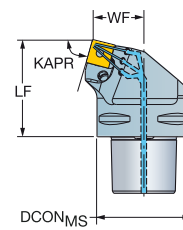

C

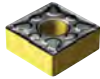

- SNMM
- SNMG
- SNMA, SNGA

D

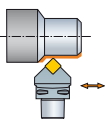

CZC _{MS}	C6	DMIN ₁	DMIN ₂	RMPX	CNCS	Código para pedido	Dimensões, mm						MIID	
							DCON _{MS}	LPR	LF	WF	BAR	NM		KG
15	C6			40°	3	C6-PSDNN-00065-15HP	63.0	65.0	0.5	150	5.0	1.29	SNMG 15 06 12	
19	C6			40°	3	C6-PSDNN-00065-19HP	63.0	65.0	0.5	150	10.0	1.29	SNMG 19 06 12	
15	C6	125.0		10°	3	C6-PSKNR/L-45065-15HP	63.0	68.8	65.0	45.0	150	5.0	1.52	SNMG 15 06 12
19	C6	125.0		10°	3	C6-PSKNR/L-45065-19HP	63.0	69.6	65.0	45.0	150	10.0	1.60	SNMG 19 06 12
15	C6	190.0		10°	3	C6-PSRNR/L-35065-15HP	63.0	65.0	35.0	150	5.0	1.48	SNMG 15 06 12	
19	C6	190.0		10°	3	C6-PSRNR/L-35065-19HP	63.0	65.0	35.0	150	10.0	1.47	SNMG 19 06 12	

N = neutra, R = versão direita, L = versão esquerda

F

Componentes						
CZC _{MS}	Alavanca	Parafuso	Calço	Rebite elástico	Olhal	
15	438.3-840	438.3-831	174.3-857	174.3-864	5691 026-03	
19	174.3-842M	174.3-822M	174.3-852M	174.3-862	5691 026-03	

Para a lista completa de componentes, acesse www.sandvik.coromant.com

G

H



Unidade de corte T-Max® P para torneamento

Fixação por alavanca

Coromant Capto® - Refrigeração de precisão

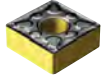

- SNMM
- SNMG
- SNMA, SNGA

KAPR

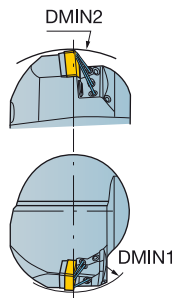

45.0°

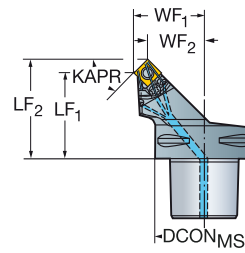

CZC _{MS}	CNC	DMIN ₁	DMIN ₂	CNSC	Código para pedido	Dimensões, mm							MID
						DCON _{MS}	LPR	LF	WF	BAR	NM	KG	
12	C4	90.0	145.0	3	C4-PSSNR/L-27042-12HP	40.0	50.3	42.0	27.0	150	5.0	0.41	SNMG 12 04 08
	C5	110.0	165.0	3	C5-PSSNR/L-35052-12HP	50.0	60.3	52.0	35.0	150	5.0	0.75	SNMG 12 04 08
	C6	110.0	200.0	3	C6-PSSNR/L-45056-12HP	63.0	64.3	56.0	45.0	150	5.0	1.19	SNMG 12 04 08
	C8	200.0	260.0	3	C8-PSSNR/L-55080-12HP	80.0	88.3	80.0	55.0	150	5.0	2.57	SNMG 12 04 08
15	C6	110.0	200.0	3	C6-PSSNR/L-45054-15HP	63.0	64.2	54.0	45.0	150	5.0	1.23	SNMG 15 06 12
19	C6	110.0	180.0	3	C6-PSSNR/L-45052-19HP	63.0	64.5	52.0	45.0	150	10.0	1.20	SNMG 19 06 12
	C8	200.0	260.0	3	C8-PSSNR/L-55080-19HP	80.0	92.5	80.0	55.0	150	10.0	2.72	SNMG 19 06 12
	C10	260.0	315.0	3	C10-PSSNL-68092-19HP	100.0	104.5	92.0	68.0	150	10.0	5.10	SNMG 19 06 12

R = versão direita, L = versão esquerda

Componentes						
CZC _{MS}	Alavanca	Parafuso	Calço	Rebite elástico	Olhal	
12	C4-C8	174.3-841M	174.3-821	174.3-851M	174.3-861	5691 026-03
15	C6	438.3-840	438.3-831	174.3-857	174.3-864	5691 026-03
19	C6-C10	174.3-842M	174.3-822M	174.3-852M	174.3-862	5691 026-03

Para a lista completa de componentes, acesse www.sandvik.coromant.com



A152



F2



E1



G1



H36



H10



H5

A

Unidade de corte T-Max® P para torneamento

Fixação rígida

Coromant Capto® - Refrigeração interna

B



KAPR

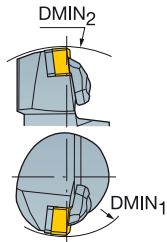

Cx-DSDNN
45.0°

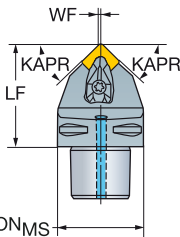

Cx-DSKNR/L
75.0°

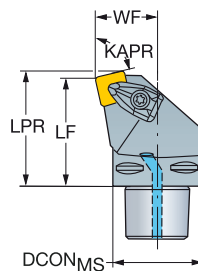

Cx-DSRNR/L
75.0°

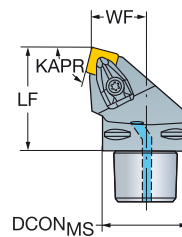

C

- SNMM
- SNMG
- SNMA, SNGA

D

CZC _{MS}	C	DMIN ₁	DMIN ₂	RMPX	CNSC	Código para pedido	Dimensões, mm						MID
							DCON _{MS}	LPR	LF	WF	BAR	NM	
12	C3	124.0	40°	3	C3-DSDNN-00048-12	32.0	48.0	0.3	10	3.9	0.23	SNMG 12 04 08	
12	C4	140.0	40°	3	C4-DSDNN-00050-12	40.0	50.0	0.3	10	3.9	0.40	SNMG 12 04 08	
12	C5	165.0	40°	3	C5-DSDNN-00060-12	50.0	60.0	0.3	10	3.9	0.78	SNMG 12 04 08	
12	C6	190.0	40°	3	C6-DSDNN-00065-12	63.0	65.0	0.3	10	3.9	1.20	SNMG 12 04 08	
15	C5	165.0	40°	3	C5-DSDNN-00060-15	50.0	60.0	0.5	10	6.4	0.70	SNMG 15 06 12	
15	C6	190.0	40°	3	C6-DSDNN-00065-15	63.0	65.0	0.5	10	6.4	1.20	SNMG 15 06 12	
19	C5	170.0	40°	3	C5-DSDNN-00065-19	50.0	65.0	0.5	10	6.4	0.76	SNMG 19 06 12	
19	C6	195.0	40°	3	C6-DSDNN-00070-19	63.0	70.0	0.5	10	6.4	1.24	SNMG 19 06 12	
12	C4	110.0	10°	3	C4-DSKNR/L-27050-12	40.0	53.1	50.0	27.0	10	3.9	0.47	SNMG 12 04 08
12	C5	110.0	10°	3	C5-DSKNR/L-35060-12	50.0	63.1	60.0	35.0	10	3.9	0.85	SNMG 12 04 08
15	C5	125.0	10°	3	C5-DSKNR/L-35060-15	50.0	63.8	60.0	35.0	10	6.4	0.85	SNMG 15 06 12
15	C6	125.0	10°	3	C6-DSKNR/L-45065-15	63.0	68.8	65.0	45.0	10	6.4	1.38	SNMG 15 06 12
19	C6	125.0	10°	3	C6-DSKNR/L-45065-19	63.0	69.6	65.0	45.0	10	6.4	1.50	SNMG 19 06 12
19	C8	125.0	10°	3	C8-DSKNR/L-55080-19	80.0	84.6	80.0	55.0	10	6.4	2.68	SNMG 19 06 12
12	C3	124.0	10°	3	C3-DSRNR-19048-12	32.0	48.0	19.0	10	3.9	0.26	SNMG 12 04 08	
12	C4	140.0	10°	3	C4-DSRNR/L-22050-12	40.0	50.0	22.0	10	3.9	0.40	SNMG 12 04 08	
12	C5	165.0	10°	3	C5-DSRNR/L-27060-12	50.0	60.0	27.0	10	3.9	0.72	SNMG 12 04 08	
12	C6	190.0	10°	3	C6-DSRNR/L-35065-12	63.0	65.0	35.0	10	3.9	1.24	SNMG 12 04 08	
15	C5	165.0	10°	3	C5-DSRNR/L-27060-15	50.0	60.0	27.0	10	6.4	0.76	SNMG 15 06 12	
15	C6	190.0	10°	3	C6-DSRNR/L-35065-15	63.0	65.0	35.0	10	6.4	1.31	SNMG 15 06 12	
19	C6	190.0	10°	3	C6-DSRNR/L-35065-19	63.0	65.0	35.0	10	6.4	1.30	SNMG 19 06 12	
19	C8	250.0	10°	3	C8-DSRNR/L-45080-19	80.0	80.0	45.0	10	6.4	2.54	SNMG 19 06 12	

N = neutra, R = versão direita, L = versão esquerda

F

Componentes					
CZC _{MS}	C	Parafuso do calço	Calço	Jogo de fixação	Olhal
12	C3	5513 020-02	5322 426-02	5412 028-021	
12	C4	5513 020-02	5322 425-01	5412 028-021	5691 034-01
12	C5-C6	5513 020-02	5322 425-01	5412 028-021	5691 045-01
15	C5-C6	5513 020-07	5322 425-03	5412 028-031	5691 045-01
19	C5-C8	5513 020-07	5322 425-04	5412 028-041	5691 045-01

Para a lista completa de componentes, acesse www.sandvik.coromant.com

G



Unidade de corte T-Max® P para torneamento

Fixação rígida

Coromant Capto® - Refrigeração interna



- SNMM
- SNMG
- SNMA, SNGA

KAPR

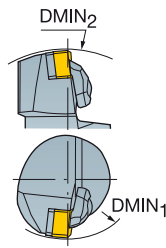

45.0°

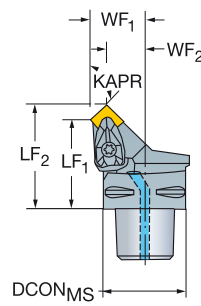

Código para pedido	Dimensões, mm												
	CZC _{MS}	DMIN ₁	DMIN ₂	CNSC	DCON _{MS}	LPR	LF	WF	BAR	NM	KG	MID	
12	C4	110.0	140.0	3	C4-DSSNR/L-27042-12	40.0	50.3	42.0	27.0	10	3.9	0.36	SNMG 12 04 08
	C5	110.0	165.0	3	C5-DSSNR/L-35052-12	50.0	60.3	52.0	35.0	10	3.9	0.68	SNMG 12 04 08
	C6	110.0	190.0	3	C6-DSSNR/L-45056-12	63.0	64.3	56.0	45.0	10	3.9	1.10	SNMG 12 04 08
15	C5	125.0	165.0	3	C5-DSSNR/L-35050-15	50.0	60.2	50.0	35.0	10	6.4	0.70	SNMG 15 06 12
	C6	125.0	190.0	3	C6-DSSNR/L-45054-15	63.0	64.2	54.0	45.0	10	6.4	1.12	SNMG 15 06 12
19	C6	125.0	190.0	3	C6-DSSNR/L-45052-19	63.0	64.5	52.0	45.0	10	6.4	1.15	SNMG 19 06 12

R = versão direita, L = versão esquerda

Componentes					
CZC _{MS}	Parafuso do calço	Calço	Jogo de fixação	Olhal	
12	C4	5513 020-02	5322 425-01	5412 028-021	5691 034-01
12	C5	5513 020-02	5322 425-01	5412 028-021	5691 034-02
12	C6	5513 020-02	5322 425-01	5412 028-021	5691 045-01
15	C5	5513 020-07	5322 425-03	5412 028-031	5691 034-02
15	C6	5513 020-07	5322 425-03	5412 028-031	5691 045-01
19	C6	5513 020-07	5322 425-04	5412 028-041	5691 034-02

Para a lista completa de componentes, acesse www.sandvik.coromant.com



Unidade de corte T-Max® P para torneamento

Fixação rígida

Coromant Capto® - Refrigeração interna

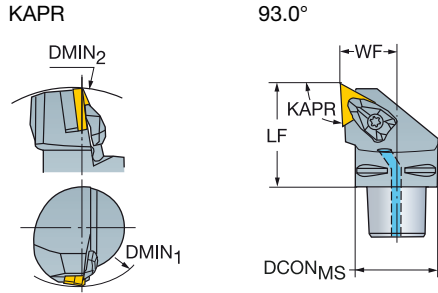

- C
- TNMM, TNMX
 - TNMG
 - TNMA, TNGA

D

CZC _{MS}	C4	DMIN ₁	DMIN ₂	CNSC	Código para pedido	Dimensões, mm						MIID
						DCON _{MS}	LF	WF	BAR	NM	KG	
16	C4	110.0	140.0	3	C4-DTJNR/L-27050-16	40.0	50.0	27.0	10	1.7	0.43	TNMG 16 04 08
	C5	110.0	165.0	3	C5-DTJNR/L-35060-16	50.0	60.0	35.0	10	1.7	0.78	TNMG 16 04 08
	C6	110.0	190.0	3	C6-DTJNR/L-45065-16	63.0	65.0	45.0	10	1.7	1.34	TNMG 16 04 08
22	C4	110.0	140.0	3	C4-DTJNR-27050-22	40.0	50.0	27.0	10	3.9	0.05	TNMG 22 04 08
	C5	110.0	165.0	3	C5-DTJNR/L-35060-22	50.0	60.0	35.0	10	3.9	0.98	TNMG 22 04 08
	C6	110.0	190.0	3	C6-DTJNR/L-45065-22	63.0	65.0	45.0	10	3.9	1.40	TNMG 22 04 08

R = versão direita, L = versão esquerda

E

		Componentes			
CZC _{MS}	Parafuso do calço	Calço	Jogo de fixação	Olhal	
16	C4-C6	5513 020-04	5322 315-02	5412 028-011	5691 045-01
22	C4-C6	5513 020-02	5322 315-04	5412 028-021	5691 045-01

Para a lista completa de componentes, acesse www.sandvik.coromant.com



Unidade de corte T-Max® P para torneamento

Fixação rígida

Coromant Capto® - Refrigeração interna

KAPR

95.0°



VNMG

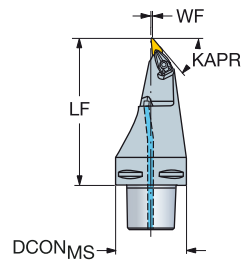

Ferramentas para usinagem multitarefas

				Dimensões, mm								
				Código para pedido	DCON _{MS}	LF	WF	BAR	NM	KG	MIID	
	16	CZC _{MS} C8	RMPX 45°	CNSC 3	C8-DVMNL-00160-16	80.0	160.0	1.2	10	3.0	3.85	VNMG 16 04 08

L = versão esquerda

Componentes			
Parafuso do calço	Calço	Jogo de fixação	Olhal
5513 020-09	5322 269-01	5412 028-061	5691 034-03

Para a lista completa de componentes, acesse www.sandvik.coromant.com



Unidade de corte T-Max® P para torneamento

Fixação rígida

Coromant Capto® - Refrigeração interna

B

KAPR

Cx-DVJNR/L
93.0°

Cx-DVVNN
72.5°

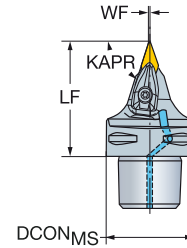
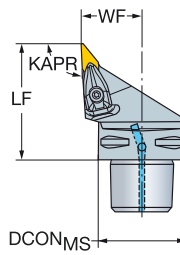
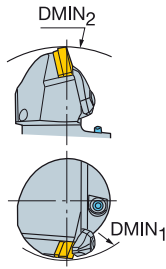

C

VNMG

D

Código para pedido	CZC _{MS}	DMIN ₁	DMIN ₂	RMPX	CNSC	Código para pedido	Dimensões, mm						MID	
							DCON _{MS}	LF	WF	BAR	NM	KG		
	16	C4	60.0	152.0	50°	3	C4-DVJNR/L-27062-16	40.0	62.0	27.0	10	3.0	0.45	VNMG 16 04 08
		C5	65.0	170.0	50°	3	C5-DVJNR/L-35065-16	50.0	65.0	35.0	10	3.0	0.72	VNMG 16 04 08
		C6	81.0	190.0	50°	3	C6-DVJNR/L-45065-16	63.0	65.0	45.0	10	3.0	1.13	VNMG 16 04 08
		C8	100.0	250.0	50°	3	C8-DVJNR/L-55080-16	80.0	80.0	55.0	10	3.0	2.22	VNMG 16 04 08
	16	C4		152.0	70°	3	C4-DVVNN-00062-16	40.0	62.0	0.6	10	3.0	0.41	VNMG 16 04 08
		C5		170.0	70°	3	C5-DVVNN-00065-16	50.0	65.0	0.6	10	3.0	0.63	VNMG 16 04 08
		C6		190.0	70°	3	C6-DVVNN-00065-16	63.0	65.0	0.6	10	3.0	1.03	VNMG 16 04 08
		C8		250.0	70°	3	C8-DVVNN-00080-16	80.0	80.0	0.6	10	3.0	2.00	VNMG 16 04 08

N = neutra, R = versão direita, L = versão esquerda

E

Código para pedido	Componentes			
	Parafuso do calço	Calço	Jogo de fixação	Olhal
C4-DVJNR/L-27062-16	5513 020-09	5322 269-01	5412 028-061	5691 034-01
C4-DVVNN-00062-16	5513 020-09	5322 269-01	5412 028-061	5691 034-01
C5-DVJNR/L-35065-16	5513 020-09	5322 269-01	5412 028-061	5691 034-02
C5-DVVNN-00065-16	5513 020-09	5322 269-01	5412 028-061	5691 045-01
C6-DVJNR/L-45065-16	5513 020-09	5322 269-01	5412 028-061	5691 034-02
C6-DVVNN-00065-16	5513 020-09	5322 269-01	5412 028-061	5691 045-01
C8-DVJNR/L-55080-16	5513 020-09	5322 269-01	5412 028-061	5691 034-03
C8-DVVNN-00080-16	5513 020-09	5322 269-01	5412 028-061	5691 045-01

Para a lista completa de componentes, acesse www.sandvik.coromant.com

F

G

H



Unidade de corte T-Max® P para torneamento

Fixação rígida

Coromant Capto® - Refrigeração interna



- WNMM,
- WNMG
- WNGA, WNMA

KAPR

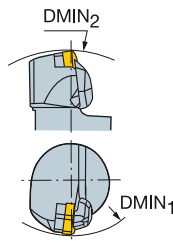

95.0°

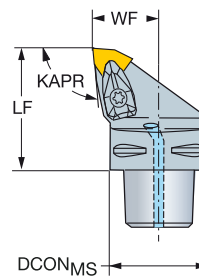

CZC _{MS}	DMIN ₁	DMIN ₂	CNSC	Código para pedido	Dimensões, mm						MIID	
					DCON _{MS}	LF	WF	BAR	NM	KG		
06	C3	60.0	116.0	3	C3-DWLNRL-22040-06	32.0	40.0	22.0	10	1.7	0.21	WNMG 06 04 08
	C4	60.0	140.0	3	C4-DWLNRL-27050-06	40.0	50.0	27.0	10	1.7	0.43	WNMG 06 04 08
	C5	65.0	165.0	3	C5-DWLNRL-35060-06	50.0	60.0	35.0	10	1.7	0.74	WNMG 06 04 08
	C6	81.0	190.0	3	C6-DWLNRL-45065-06	63.0	65.0	45.0	10	1.7	1.33	WNMG 06 04 08
08	C4	110.0	140.0	3	C4-DWLNRL-27050-08	40.0	50.0	27.0	10	3.9	0.43	WNMG 08 04 08
	C5	110.0	165.0	3	C5-DWLNRL-35060-08	50.0	60.0	35.0	10	3.9	0.74	WNMG 08 04 08
	C6	110.0	190.0	3	C6-DWLNRL-45065-08	63.0	65.0	45.0	10	3.9	1.34	WNMG 08 04 08
	C8	110.0	250.0	3	C8-DWLNRL-55080-08	80.0	80.0	55.0	10	3.9	2.58	WNMG 08 04 08

R = versão direita, L = versão esquerda

Componentes					
CZC _{MS}	Parafuso do calço	Calço	Jogo de fixação	Olhal	
06	C3	5513 020-04	5322 328-01	5412 028-011	
06	C4	5513 020-04	5322 328-01	5412 028-011	5691 034-01
06	C5-C6	5513 020-04	5322 328-01	5412 028-011	5691 045-01
08	C4	5513 020-02	5322 331-12	5412 028-021	5691 034-01
08	C5-C8	5513 020-02	5322 331-12	5412 028-021	5691 045-01

Para a lista completa de componentes, acesse www.sandvik.coromant.com



A

Unidade de corte T-Max® P para torneamento

Fixação por alavanca

Coromant Capto® - Refrigeração de precisão

B



KAPR

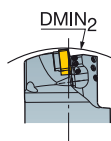

75.0°

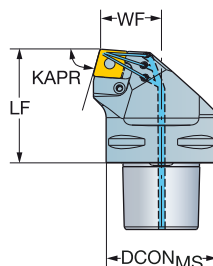

C



D

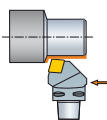

					Dimensões, mm								
CZC _{MS}	DMIN ₂	CNSC	Código para pedido		DCON _{MS}	LF	WF	BAR	NM	KG	MIID		
16	C6	190.0	3	C6-PCRN/L-35065-16HP	63.0	65.0	35.0	150	5.0	1.50	CNMG 16 06 12		
19	C6	190.0	3	C6-PCRN/L-35065-19HP	63.0	65.0	35.0	150	10.0	1.48	CNMG 19 06 12		

R = versão direita, L = versão esquerda

E

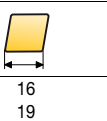

Componentes

CZC _{MS}	Alavanca	Parafuso	Calço	Rebite elástico	Olhal
16	438.3-840	438.3-831	171.31-852	174.3-864	5691 026-03
19	174.3-842M	174.3-822M	171.31-851M	174.3-862	5691 026-03

Para a lista completa de componentes, acesse www.sandvik.coromant.com

F

G

H



A152



F2



E1



G1



H36



H10



H5

Ferramenta convencional T-Max® P para torneamento

Fixação por alavanca

Refrigeração de precisão



- CNMM
- CNMG
- CNMA, CNGA

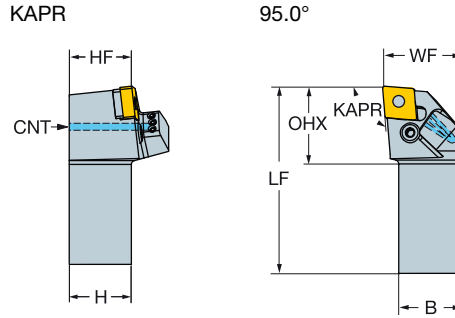

	Dimensões, mm													MIID	
	CZC _{MS}	OHX	CNSC	Código para pedido	B	H	LF	WF	HF	CNT	BAR	NM	KG		
	12	32 x 25	30.1	1	PCLNR/L 3225P 12HP	25.0	32.0	170.0	32.0	32.0	G 1/8-28	275	5.0	1.09	CNMG 12 04 08
		32 x 32	31.3	1	PCLNR/L 3232P 12HP	32.0	32.0	170.0	40.0	32.0	G 1/8-28	275	5.0	1.37	CNMG 12 04 08
	16	25 x 25	32.6	1	PCLNR/L 2525M 16HP	25.0	25.0	150.0	32.0	25.0	G 1/8-28	275	5.0	0.78	CNMG 16 06 12
		32 x 32	33.9	1	PCLNR/L 3232P 16HP	32.0	32.0	170.0	40.0	32.0	G 1/8-28	275	5.0	1.38	CNMG 16 06 12

R = versão direita, L = versão esquerda

Componentes						
CZC _{MS}	Alavanca	Parafuso	Calço	Rebite elástico	Olhal	
12	32 x 25-32 x 32	174.3-841M	174.3-821	171.31-850M	174.3-861	5691 026-13
16	25 x 25-32 x 32	438.3-840	438.3-831	171.31-852	174.3-864	5691 026-13

Para a lista completa de componentes, acesse www.sandvik.coromant.com



Ferramenta convencional T-Max® P para torneamento

Fixação rígida

POB

B

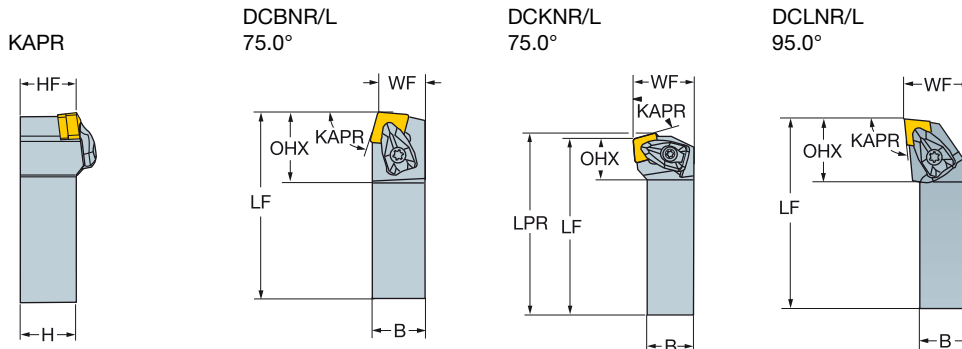

C

- CNMM
- CNMG
- CNMA, CNGA

D

CZC _{MS}	OHX	Código para pedido	Dimensões, mm							NM	KG	MIID
			B	H	LPR	LF	WF	HF				
	12	20 x 20	DCBNR/L 2020K 12	20.0	20.0	170.0	17.0	20.0	3.9	0.43	CNMG 12 04 08	
	25 x 25	DCBNR/L 2525M 12	25.0	25.0	150.0	22.0	25.0	3.9	0.76	CNMG 12 04 08		
	32 x 25	DCBNR/L 3225P 12	25.0	32.0	170.0	22.0	32.0	3.9	1.09	CNMG 12 04 08		
	32 x 32	DCBNR/L 3232P 12	32.0	32.0	170.0	27.0	32.0	3.9	1.35	CNMG 12 04 08		
	16	25 x 25	DCBNR/L 2525M 16	25.0	25.0	150.0	22.0	25.0	6.4	0.79	CNMG 16 06 12	
	32 x 25	DCBNR/L 3225P 16	25.0	32.0	170.0	22.0	32.0	6.4	1.11	CNMG 16 06 12		
	32 x 32	DCBNR/L 3232P 16	32.0	32.0	170.0	27.0	32.0	6.4	1.39	CNMG 16 06 12		
	19	32 x 32	DCBNR/L 3232P 19	32.0	32.0	170.0	27.0	32.0	6.4	1.39	CNMG 19 06 12	
	12	20 x 20	DCKNR/L 2020K 12	20.0	20.0	128.1	125.0	25.0	3.9	0.46	CNMG 12 04 08	
	25 x 25	DCKNR/L 2525M 12	25.0	25.0	153.1	150.0	32.0	3.9	0.80	CNMG 12 04 08		
	32 x 25	DCKNR/L 3225P 12	25.0	32.0	173.1	170.0	32.0	3.9	1.10	CNMG 12 04 08		
	16	32 x 32	DCKNR/L 3232P 16	32.0	32.0	173.8	170.0	40.0	6.4	1.44	CNMG 16 06 12	
	09	16 x 16	DCLNR/L 1616H 09	16.0	16.0	100.0	20.0	16.0	1.7	0.22	CNMG 09 03 08	
	20 x 20	DCLNR/L 2020K 09	20.0	20.0	125.0	25.0	20.0	1.7	0.43	CNMG 09 03 08		
	25 x 25	DCLNR/L 2525M 09	25.0	25.0	150.0	32.0	25.0	1.7	0.75	CNMG 09 03 08		
	12	16 x 16	DCLNR/L 1616H 12	16.0	16.0	100.0	20.0	16.0	3.9	0.26	CNMG 12 04 08	
	20 x 20	DCLNR/L 2020K 12	20.0	20.0	125.0	25.0	20.0	3.9	0.44	CNMG 12 04 08		
	25 x 25	DCLNR/L 2525M 12	25.0	25.0	150.0	32.0	25.0	3.9	0.77	CNMG 12 04 08		
	32 x 25	DCLNR/L 3225P 12	25.0	32.0	170.0	32.0	32.0	3.9	1.11	CNMG 12 04 08		
	32 x 32	DCLNR/L 3232P 12	32.0	32.0	170.0	40.0	32.0	3.9	1.38	CNMG 12 04 08		
	16	25 x 25	DCLNR/L 2525M 16	25.0	25.0	150.0	32.0	25.0	6.4	0.81	CNMG 16 06 12	
	32 x 25	DCLNR/L 3225P 16	25.0	32.0	170.0	32.0	32.0	6.4	1.13	CNMG 16 06 12		
	32 x 32	DCLNR/L 3232P 16	32.0	32.0	170.0	40.0	32.0	6.4	1.41	CNMG 16 06 12		
	19	25 x 25	DCLNR/L 2525M 19	25.0	25.0	150.0	32.0	25.0	6.4	0.82	CNMG 19 06 12	
	32 x 32	DCLNR/L 3232P 19	32.0	32.0	170.0	40.0	32.0	6.4	1.41	CNMG 19 06 12		

F

R = versão direita, L = versão esquerda

G

Componentes				
CZC _{MS}	Parafuso do calço	Calço	Jogo de fixação	
09	16 x 16-25 x 25	5513 020-04	5322 236-04	5412 028-011
12	16 x 16	5513 020-02	5322 236-03	5412 028-021
12	20 x 20-32 x 32	5513 020-02	5322 234-01	5412 028-021
16	25 x 25-32 x 32	5513 020-07	5322 234-04	5412 028-031
19	25 x 25-32 x 32	5513 020-07	5322 236-01	5412 028-041

Para a lista completa de componentes, acesse www.sandvik.coromant.com

H



Ferramenta convencional T-Max® P para torneamento

Fixação por alavanca

Refrigeração de precisão

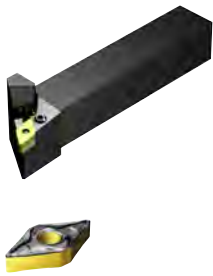

KAPR

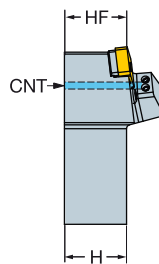

93.0°

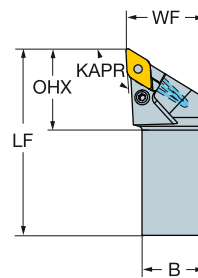

- DNMM, DNMX
- DNMG
- DNMA, DNGA

		CZC _{MS}	RMPX	OHX	CNCS	Código para pedido	Dimensões, mm							MIID			
							B	H	LF	WF	HF	CNT	BAR		NM	KG	
	RMPX	11	16 x 16	27°	36.9	1	PDJNR/L 1616H 11HP	16.0	16.0	100.0	20.0	16.0	G 1/8-28	275	2.0	0.24	DNMG 11 04 08
			20 x 20	27°	36.4	1	PDJNR/L 2020K 11HP	20.0	20.0	125.0	25.0	20.0	G 1/8-28	275	2.0	0.42	DNMG 11 04 08
			25 x 25	27°	32.8	1	PDJNR/L 2525M 11HP	25.0	25.0	150.0	32.0	25.0	G 1/8-28	275	2.0	0.75	DNMG 11 04 08
		15	32 x 25	27°	38.4	1	PDJNR/L 3225P 15HP	25.0	32.0	170.0	32.0	32.0	G 1/8-28	275	5.0	1.07	DNMG 15 06 08
			32 x 32	27°	41.6	1	PDJNR/L 3232P 15HP	32.0	32.0	170.0	40.0	32.0	G 1/8-28	275	5.0	1.33	DNMG 15 06 08

R = versão direita, L = versão esquerda

Componentes						
	CZC _{MS}	Alavanca	Parafuso	Calço	Rebite elástico	Olhal
11	16 x 16-25 x 25	5432 001-01	174.3-820M	5322 255-01	174.3-860	5691 026-13
15	32 x 25-32 x 32	174.3-847M	174.3-830	171.35-851M	174.3-861	5691 026-13

Para a lista completa de componentes, acesse www.sandvik.coromant.com



Ferramenta convencional T-Max® P para torneamento

Fixação rígida

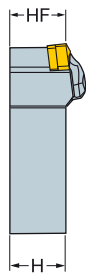
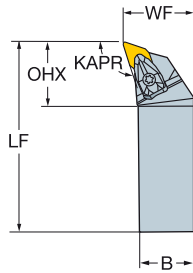
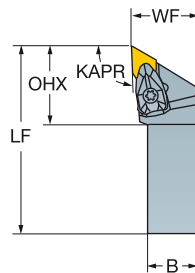
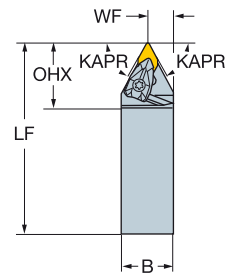

KAPR

DDHNR/L
107.5°DDJNR/L
93.0°DDNNN
62.5°

DNMM, DNMX

DNMG

DNMA, DNMA

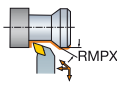

		Dimensões, mm											
		CZC _{MS}	RMPX	OHX	Código para pedido	B	H	LF	WF	HF	NM	KG	MIID
D	15	20 x 20	12°	36.1	DDHNR/L 2020K 15	20.0	20.0	125.0	25.0	20.0	3.9	0.42	DNMG 15 06 08
		25 x 25	12°	36.1	DDHNR/L 2525M 15	25.0	25.0	150.0	32.0	25.0	3.9	0.76	DNMG 15 06 08
		32 x 25	12°	36.1	DDHNR/L 3225P 15	25.0	32.0	170.0	32.0	32.0	3.9	1.09	DNMG 15 06 08
		32 x 32	12°	36.1	DDHNR/L 3232P 15	32.0	32.0	170.0	40.0	32.0	3.9	1.34	DNMG 15 06 08
D	11	16 x 16	27°	30.1	DDJNR/L 1616H 11	16.0	16.0	100.0	20.0	16.0	1.7	0.22	DNMG 11 04 08
		20 x 20	27°	30.2	DDJNR/L 2020K 11	20.0	20.0	125.0	25.0	20.0	1.7	0.40	DNMG 11 04 08
		25 x 25	27°	30.2	DDJNR/L 2525M 11	25.0	25.0	150.0	32.0	25.0	1.7	0.73	DNMG 11 04 08
		20 x 20	27°	39.4	DDJNR/L 2020K 15	20.0	20.0	125.0	25.0	20.0	3.9	0.43	DNMG 15 06 08
		25 x 25	27°	39.4	DDJNR/L 2525M 15	25.0	25.0	150.0	32.0	25.0	3.9	0.75	DNMG 15 06 08
		32 x 25	27°	39.4	DDJNR/L 3225P 15	25.0	32.0	170.0	32.0	32.0	3.9	1.06	DNMG 15 06 08
E	15	20 x 20	27°	39.4	DDJNR/L 3232P 15	32.0	32.0	170.0	40.0	32.0	3.9	1.33	DNMG 15 06 08
		20 x 20	57°	31.2	DDNNN 2020K 11	20.0	20.0	125.0	10.5	20.0	1.7	0.39	DNMG 11 04 08
		25 x 25	57°	31.2	DDNNN 2525M 11	25.0	25.0	150.0	13.0	25.0	1.7	0.72	DNMG 11 04 08
		25 x 25	57°	40.8	DDNNN 2525M 15	25.0	25.0	150.0	13.0	25.0	3.9	0.72	DNMG 15 06 08
E	15	32 x 25	57°	40.8	DDNNN 3225P 15	25.0	32.0	170.0	13.0	32.0	3.9	1.03	DNMG 15 06 08
		32 x 32	57°	40.8	DDNNN 3232P 15	32.0	32.0	170.0	16.5	32.0	3.9	1.28	DNMG 15 06 08

N = neutra, R = versão direita, L = versão esquerda

Componentes

Parafuso do calço	Calço	Jogo de fixação
5513 020-04	5322 267-01	5412 028-011
5513 020-02	5322 266-02	5412 028-021

Para a lista completa de componentes, acesse www.sandvik.coromant.com



A152



F2



E1



H36



H10

Ferramenta convencional T-Max® P para torneamento

Fixação por alavanca

Redonda (pos.)



RCMX
RCMT
RCGX AL

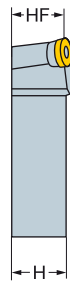

PRGCR/L

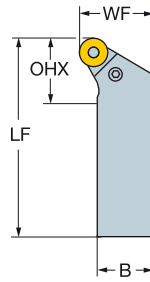

PRDCN

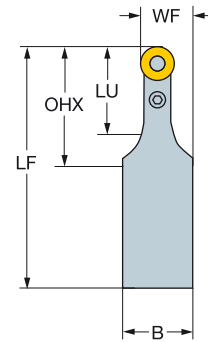

	CZC _{MS}	LU	RMPX	OHX	Código para pedido	Dimensões, mm						MIID		
						B	H	LF	WF	HF	NM		KG	
	10	20 x 20	25.0	90°	30.0	PRDCN 2020K 10	20.0	20.0	125.0	15.0	20.0	2.0	0.37	RCMX 10 03 00
	12	25 x 25	28.0	90°	33.0	PRDCN 2525M 12	25.0	25.0	150.0	18.5	25.0	4.0	0.67	RCMX 12 04 00
		32 x 25	28.0	90°	33.0	PRDCN 3225P 12	25.0	32.0	170.0	18.5	32.0	4.0	0.98	RCMX 12 04 00
	16	32 x 25	35.0	90°	40.0	PRDCN 3225P 16	25.0	32.0	170.0	20.5	32.0	4.0	0.98	RCMX 16 06 00
20		32 x 32	40.0	90°	45.0	PRDCN 3232P 20	32.0	32.0	170.0	26.0	32.0	8.0	1.23	RCMX 20 06 00
	10	20 x 20	27°	20.8	PRGCR/L 2020K 10	20.0	20.0	125.0	25.0	20.0	2.0	0.40	RCMX 10 03 00	
		25 x 25	27°	27.2	PRGCR/L 2525M 10	25.0	25.0	150.0	32.0	25.0	2.0	0.76	RCMX 10 03 00	
	12	20 x 20	27°	20.8	PRGCR/L 2020K 12	20.0	20.0	125.0	25.0	20.0	4.0	0.41	RCMX 12 04 00	
		25 x 25	27°	27.2	PRGCR/L 2525M 12	25.0	25.0	150.0	32.0	25.0	4.0	0.76	RCMX 12 04 00	
	16	32 x 25	27°	32.0	PRGCR/L 3225P 12	25.0	32.0	170.0	32.0	32.0	4.0	1.07	RCMX 12 04 00	
		25 x 25	27°	27.2	PRGCR/L 2525M 16	25.0	25.0	150.0	32.0	25.0	4.0	0.76	RCMX 16 06 00	
20	32 x 25	27°	33.2	PRGCR/L 3225P 16	25.0	32.0	170.0	32.0	32.0	4.0	1.08	RCMX 16 06 00		
	32 x 32	27°	38.0	PRGCR/L 3232P 20	32.0	32.0	170.0	40.0	32.0	8.0	1.35	RCMX 20 06 00		

N = neutra, R = versão direita, L = versão esquerda

Componentes					
CZC _{MS}	Alavanca	Parafuso	Calço	Rebite elástico	
10	20 x 20-25 x 25	176.39-840	174.3-834	176.39-850	174.3-860
12	20 x 20-32 x 25	5432 005-01	174.3-820M	176.39-851	174.3-863
16	25 x 25-32 x 25	176.39-842	174.3-833	176.39-852	174.3-867
20	32 x 32	176.39-843	174.3-825	176.39-853	174.3-864

Para a lista completa de componentes, acesse www.sandvik.coromant.com



Ferramenta convencional T-Max® P para torneamento

Fixação rígida

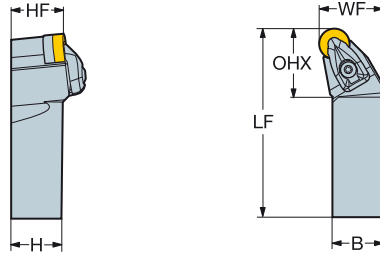
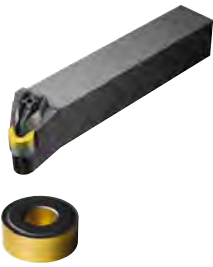

- RNMG
- RNGA

Código para pedido	Dimensões, mm		Código para pedido		Dimensões, mm		Código para pedido		Dimensões, mm		MIID				
	B	H	LF	WF	HF	NM	KG	B	H	LF		WF	HF	NM	KG
DRSNR/L 2525M 12	25.0	25.0	150.0	32.0	25.0	3.9	0.74	DRSNR/L 3225P 15	25.0	32.0	170.0	32.0	32.0	6.4	1.04
DRSNR/L 3232P 19	32.0	32.0	170.0	40.0	32.0	6.4	1.34								

R = versão direita, L = versão esquerda

Componentes				
CZC _{MS}	Parafuso do calço	Calço	Jogo de fixação	
12	25 x 25	5513 020-02	5322 155-02	5412 028-021
15	32 x 25	5513 020-07	5322 155-04	5412 028-031
19	32 x 32	5513 020-07	5322 155-06	5412 028-041

Para a lista completa de componentes, acesse www.sandvik.coromant.com



Ferramenta convencional T-Max® P para torneamento

Fixação rígida



- SNMM
- SNMG
- SNMA, SNGA

KAPR

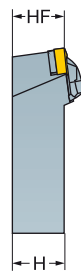

DSBNR/L
75.0°

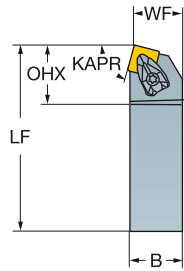

DSDNN
45.0°

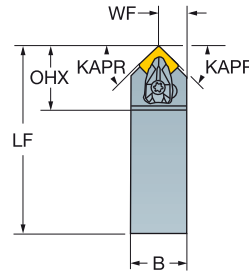

	CZC _{MS}	RMPX	OHX	Código para pedido	Dimensões, mm							MIID	
					B	H	LF	WF	HF	NM	KG		
	09	25 x 25	10°	26.7	DSBNR 2525M 09	25.0	25.0	150.0	22.0	25.0	1.7	0.74	SNMG 09 03 08
	12	20 x 20	10°	34.2	DSBNR/L 2020K 12	20.0	20.0	125.0	17.0	20.0	3.9	0.43	SNMG 12 04 08
		25 x 25	10°	34.3	DSBNR/L 2525M 12	25.0	25.0	150.0	22.0	25.0	3.9	0.75	SNMG 12 04 08
		32 x 25	10°	34.3	DSBNR/L 3225P 12	25.0	32.0	170.0	22.0	32.0	3.9	1.12	SNMG 12 04 08
	15	25 x 25	10°	41.6	DSBNR/L 2525M 15	25.0	25.0	150.0	22.0	25.0	6.4	0.79	SNMG 15 06 12
		32 x 32	10°	41.5	DSBNR/L 3232P 15	32.0	32.0	170.0	27.0	32.0	6.4	1.38	SNMG 15 06 12
19	32 x 32	10°	46.4	DSBNR/L 3232P 19	32.0	32.0	170.0	27.0	32.0	6.4	1.38	SNMG 19 06 12	
	09	16 x 16	40°	28.1	DSDNN 1616H 09	16.0	16.0	100.0	8.3	16.0	1.7	0.21	SNMG 09 03 08
	12	20 x 20	40°	36.5	DSDNN 2020K 12	20.0	20.0	125.0	10.3	20.0	3.9	0.43	SNMG 12 04 08
		25 x 25	40°	36.5	DSDNN 2525M 12	25.0	25.0	150.0	12.8	25.0	3.9	0.75	SNMG 12 04 08
		32 x 25	40°	36.5	DSDNN 3225P 12	25.0	32.0	170.0	12.8	32.0	3.9	1.04	SNMG 12 04 08
	15	32 x 32	40°	36.8	DSDNN 3232P 12	32.0	32.0	170.0	16.3	32.0	3.9	1.32	SNMG 12 04 08
		25 x 25	40°	44.8	DSDNN 2525M 15	25.0	25.0	150.0	12.8	25.0	6.4	0.75	SNMG 15 06 12
19	32 x 32	40°	49.5	DSDNN 3232P 19	32.0	32.0	170.0	16.5	32.0	6.4	1.36	SNMG 19 06 12	

N = neutra, R = versão direita, L = versão esquerda

Componentes				
CZC _{MS}	Parafuso do calço	Calço	Jogo de fixação	
09	16 x 16-25 x 25	5513 020-04	5322 426-01	5412 028-011
12	20 x 20-32 x 32	5513 020-02	5322 425-01	5412 028-021
15	25 x 25-32 x 32	5513 020-07	5322 425-03	5412 028-031
19	32 x 32	5513 020-07	5322 425-04	5412 028-041

Para a lista completa de componentes, acesse www.sandvik.coromant.com



Ferramenta convencional T-Max® P para torneamento

Fixação rígida

B

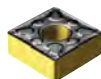

C

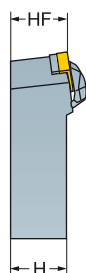
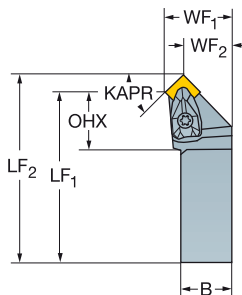
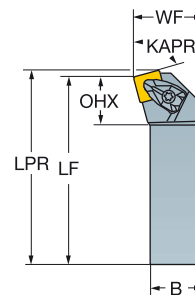

KAPR

DSSNR/L
45.0°DSKNR/L
75.0°

D

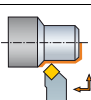
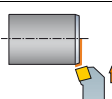

CZC _{MS}	RMPX	OHX	Código para pedido	Dimensões, mm								MIID	
				B	H	LPR	LF	WF	HF	NM	KG		
12	25 x 25	10°	23.6	DSKNR/L 2525M 12	25.0	25.0	153.1	150.0	32.0	25.0	3.9	0.79	SNMG 12 04 08
	32 x 25	10°	23.7	DSKNR/L 3225P 12	25.0	32.0	173.1	170.0	32.0	32.0	3.9	1.13	SNMG 12 04 08
12	20 x 20	0°	27.5	DSSNR/L 2020K 12	20.0	20.0	133.3	125.0	25.0	20.0	3.9	0.33	SNMG 12 04 08
	25 x 25	0°	27.5	DSSNR/L 2525M 12	25.0	25.0	158.3	150.0	32.0	25.0	3.9	0.80	SNMG 12 04 08
	32 x 25	0°	27.4	DSSNR/L 3225P 12	25.0	32.0	178.3	170.0	32.0	32.0	3.9	1.13	SNMG 12 04 08
	32 x 32	0°	27.4	DSSNR/L 3232P 12	32.0	32.0	178.3	170.0	40.0	32.0	3.9	1.40	SNMG 12 04 08
	15	25 x 25	0°	32.0	DSSNR/L 2525M 15	25.0	25.0	160.2	150.0	32.0	25.0	6.4	0.90
15	32 x 25	0°	33.1	DSSNR/L 3225P 15	25.0	32.0	180.2	170.0	32.0	32.0	6.4	1.16	SNMG 15 06 12
	32 x 32	0°	33.1	DSSNR/L 3232P 15	32.0	32.0	180.2	170.0	40.0	32.0	6.4	1.44	SNMG 15 06 12
19	32 x 32	0°	37.0	DSSNR/L 3232P 19	32.0	32.0	182.5	170.0	40.0	32.0	6.4	1.47	SNMG 19 06 12

R = versão direita, L = versão esquerda

E

Componentes				
CZC _{MS}	Parafuso do calço	Calço	Jogo de fixação	
12	20 x 20-32 x 32	5513 020-02	5322 425-01	5412 028-021
15	25 x 25-32 x 32	5513 020-07	5322 425-03	5412 028-031
19	32 x 32	5513 020-07	5322 425-04	5412 028-041

F

Para a lista completa de componentes, acesse www.sandvik.coromant.com

G

H



A152



F2



E1



H36



H10

Ferramenta convencional T-Max® P para torneamento

Fixação por alavanca

Refrigeração de precisão



- TNMM, TNMX
- TNMG
- TNMA, TNGA

KAPR

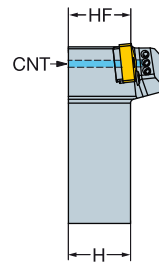

91.0°

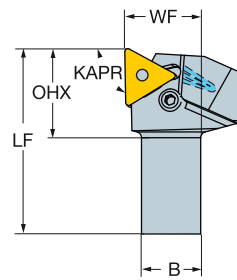

		Dimensões, mm														
		CZC _{MS}	OHX	CNSC	Código para pedido	B	H	LF	WF	HF	CNT				MIID	
	16	16 x 16	23.9	1	PTGNR/L 1616H 16HP	16.0	16.0	100.0	20.0	16.0	G 1/8-28	275	2.0	0.27	TNMG 16 04 08	
		20 x 20	23.9	1	PTGNR/L 2020K 16HP	20.0	20.0	125.0	25.0	20.0	G 1/8-28	275	2.0	0.47	TNMG 16 04 08	
		25 x 25	23.9	1	PTGNR/L 2525M 16HP	25.0	25.0	150.0	32.0	25.0	G 1/8-28	275	2.0	0.79	TNMG 16 04 08	

R = versão direita, L = versão esquerda

Componentes				
Alavanca	Parafuso	Calço	Rebite elástico	Olhal
174.3-840M	174.3-820M	179.3-850M	174.3-860	5691 026-13

Para a lista completa de componentes, acesse www.sandvik.coromant.com



A

Ferramenta convencional T-Max® P para torneamento

Fixação rígida

B



KAPR

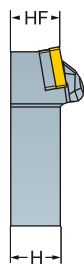

93.0°

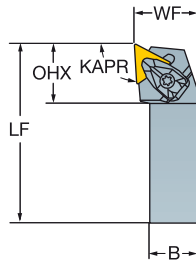

C



D

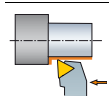

CZC _{MS}	OHX	Código para pedido	Dimensões, mm								MIID
			B	H	LF	WF	HF	NM	KG		
16	16 x 16	24.9	DTJNR/L 1616H 16	16.0	16.0	100.0	20.0	16.0	1.7	0.23	TNMG 16 04 08
	20 x 20	24.9	DTJNR/L 2020K 16	20.0	20.0	125.0	25.0	20.0	1.7	0.43	TNMG 16 04 08
	25 x 25	24.9	DTJNR/L 2525M 16	25.0	25.0	150.0	32.0	25.0	1.7	0.76	TNMG 16 04 08
	32 x 25	25.3	DTJNR/L 3225P 16	25.0	32.0	170.0	32.0	32.0	1.7	1.10	TNMG 16 04 08
22	25 x 25	32.6	DTJNR/L 2525M 22	25.0	25.0	150.0	32.0	25.0	3.9	0.90	TNMG 22 04 08
	32 x 32	32.6	DTJNR/L 3232P 22	32.0	32.0	170.0	40.0	32.0	3.9	1.42	TNMG 22 04 08

R = versão direita, L = versão esquerda

E

Componentes				
CZC _{MS}	Parafuso do calço	Calço	Jogo de fixação	
16	16 x 16	5513 020-04	5322 316-01	5412 028-011
16	20 x 20-32 x 25	5513 020-04	5322 315-02	5412 028-011
22	25 x 25-32 x 32	5513 020-02	5322 315-04	5412 028-021

Para a lista completa de componentes, acesse www.sandvik.coromant.com

F

G

H



A152



F2



E1



H36



H10

Ferramenta convencional T-Max® P para torneamento

Fixação por alavanca

Refrigeração de precisão



VNMG

KAPR

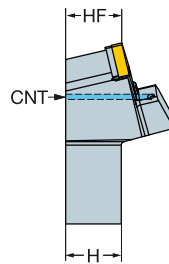

93.0°

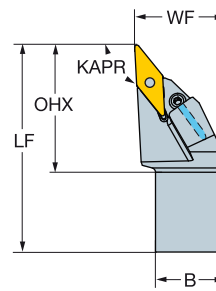

		Dimensões, mm														
	16	CZC _{MS}	RMPX	OHX	CNSC	Código para pedido	B	H	LF	WF	HF	CNT	BAR	NM	KG	MIID
	16 x 16	41°	41.6	1	PVJNR/L 1616H 16HP	16.0	16.0	100.0	20.0	16.0	G 1/8-28	275	2.0	0.25	VNMG 16 04 08	
	20 x 20	41°	42.6	1	PVJNR/L 2020K 16HP	20.0	20.0	125.0	25.0	20.0	G 1/8-28	275	2.0	0.42	VNMG 16 04 08	
	25 x 25	41°	45.7	1	PVJNR/L 2525M 16HP	25.0	25.0	150.0	32.0	25.0	G 1/8-28	275	2.0	0.75	VNMG 16 04 08	
	32 x 25	41°	45.7	1	PVJNR/L 3225P 16HP	25.0	32.0	170.0	32.0	32.0	G 1/8-28	275	2.0	1.08	VNMG 16 04 08	

R = versão direita, L = versão esquerda

Componentes				
Alavanca	Parafuso	Calço	Rebite elástico	Olhal
5432 001-02	174.3-820M	5322 256-01	174.3-860	5691 026-13

Para a lista completa de componentes, acesse www.sandvik.coromant.com



A152



F2



E1



G1



H36



H10



H5

Ferramenta convencional T-Max® P para torneamento

Fixação rígida

B

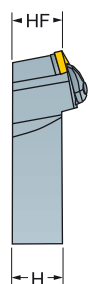
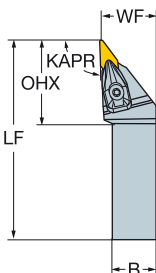
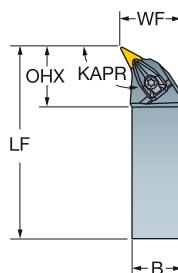
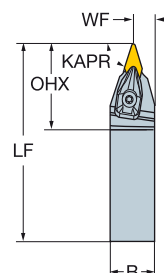

KAPR

DVJNR/L
93.0°DVPNR/L
117.5°DVVNN
72.5°

C



VNMG

D



		CZC _{MS}	RMPX	OHX	Código para pedido	Dimensões, mm						MIID	
						B	H	LF	WF	HF	NM		KG
	16	20 x 20	44°	46.6	DVJNR/L 2020K 16	20.0	20.0	125.0	25.0	20.0	3.0	0.44	VNMG 16 04 08
		25 x 25	44°	46.6	DVJNR/L 2525M 16	25.0	25.0	150.0	32.0	25.0	3.0	0.74	VNMG 16 04 08
		32 x 25	44°	46.6	DVJNR/L 3225P 16	25.0	32.0	170.0	32.0	32.0	3.0	1.06	VNMG 16 04 08
		32 x 32	44°	46.6	DVJNR/L 3232P 16	32.0	32.0	170.0	40.0	32.0	3.0	1.29	VNMG 16 04 08
	16	25 x 25	25°	39.2	DVPNR/L 2525M 16	25.0	25.0	150.0	32.0	25.0	3.0	0.80	VNMG 16 04 08
		32 x 25	25°	39.2	DVPNR/L 3225P 16	25.0	32.0	170.0	32.0	32.0	3.0	1.05	VNMG 16 04 08
		32 x 32	25°	39.2	DVPNR/L 3232P 16	32.0	32.0	170.0	40.0	32.0	3.0	1.33	VNMG 16 04 08
	16	20 x 20	70°	47.8	DVVNN 2020K 16	20.0	20.0	125.0	10.6	20.0	3.0	0.43	VNMG 16 04 08
		25 x 25	70°	47.8	DVVNN 2525M 16	25.0	25.0	150.0	13.1	25.0	3.0	0.72	VNMG 16 04 08
		32 x 25	70°	47.8	DVVNN 3225P 16	25.0	32.0	170.0	13.1	32.0	3.0	1.03	VNMG 16 04 08
		32 x 32	70°	47.8	DVVNN 3232P 16	32.0	32.0	170.0	16.6	32.0	3.0	1.25	VNMG 16 04 08

N = neutra, R = versão direita, L = versão esquerda

F

Componentes

Parafuso do calço	Calço	Jogo de fixação
5513 020-09	5322 269-01	5412 028-061

Para a lista completa de componentes, acesse www.sandvik.coromant.com

G

H



A152



F2



E1



H36

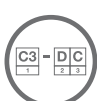

H10

Ferramenta convencional T-Max® P para torneamento

Fixação rígida



KAPR

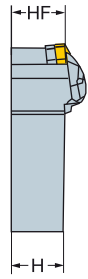

95.0°

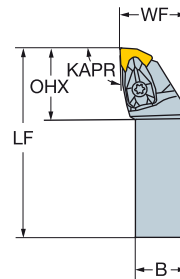

- WNMM,
- WNMG
- WNGA, WNMA

		CZC _{MS}	OHX	Código para pedido	Dimensões, mm							MID
					B	H	LF	WF	HF	NM	KG	
	06	16 x 16	26.4	DWLNRL 1616H 06	16.0	16.0	100.0	20.0	16.0	1.7	0.22	WNMG 06 04 08
		20 x 20	27.1	DWLNRL 2020K 06	20.0	20.0	125.0	25.0	20.0	1.7	0.42	WNMG 06 04 08
		25 x 25	27.1	DWLNRL 2525M 06	25.0	25.0	150.0	32.0	25.0	1.7	0.76	WNMG 06 04 08
	08	20 x 20	34.3	DWLNRL 2020K 08	20.0	20.0	125.0	25.0	20.0	3.9	0.43	WNMG 08 04 08
		25 x 25	34.3	DWLNRL 2525M 08	25.0	25.0	150.0	32.0	25.0	3.9	0.76	WNMG 08 04 08
		32 x 25	35.0	DWLNRL 3225P 08	25.0	32.0	170.0	32.0	32.0	3.9	1.10	WNMG 08 04 08
		32 x 32	34.3	DWLNRL 3232P 08	32.0	32.0	170.0	40.0	32.0	3.9	1.36	WNMG 08 04 08

R = versão direita, L = versão esquerda

Componentes				
	CZC _{MS}	Parafuso do calço	Calço	Jogo de fixação
06	16 x 16-25 x 25	5513 020-04	5322 328-01	5412 028-011
08	20 x 20-32 x 32	5513 020-02	5322 331-12	5412 028-021

Para a lista completa de componentes, acesse www.sandvik.coromant.com



A

Ferramenta convencional T-Max® P QS para torneamento

Fixação por alavanca

Refrigeração de precisão

B

KAPR
PSIR

95.0°
-5.0°

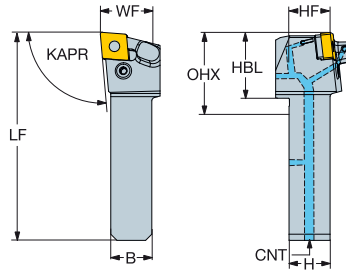

C



- CNMM
- CNMG
- CNMA, CNGA

D

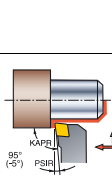

		Dimensões, mm														
		CZC _{MS}	OHX	CNSC	Código para pedido	B	H	HBL	LF	WF	HF	CNT	BAR	NM	KG	MIID
	12	20 x 20	52.0	3	QS-PCLNR/L 2020-12C	20.0	20.0	32.0	101.0	25.0	20.0	G 1/8-28	150	5.0	0.31	CNMG 12 04 08
		25 x 25	57.0	3	QS-PCLNR/L 2525-12C	25.0	25.0	32.0	116.0	32.0	25.0	G 1/8-28	150	5.0	0.54	CNMG 12 04 08

R = versão direita, L = versão esquerda

Componentes

E

Alavanca	Parafuso	Calço	Rebite elástico	Olhal	Parafuso	Parafuso	Parafuso
174.3-841M	174.3-821	171.31-850M	174.3-861	5691 026-13	5512 104-01	3214 013-01	3214 012-01

Para a lista completa de componentes, acesse www.sandvik.coromant.com

F

G

H



Ferramenta convencional T-Max® P QS para torneamento

Fixação por alavanca

Refrigeração de precisão

KAPR
PSIR

93.0°
-3.0°

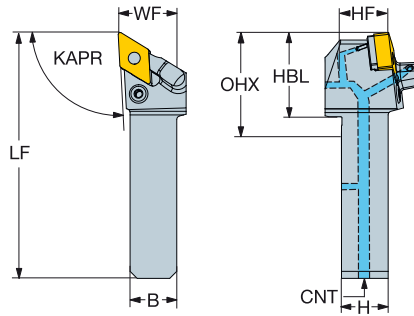

- DNMM, DNMX
- DNMG
- DNMA, DNGA

		Dimensões, mm														
	CZC _{MS}	RMPX	OHX	CNSC	Código para pedido	B	H	HBL	LF	WF	HF	CNT	BAR	NM	KG	MID
													150	5.0	0.30	
	20 x 20	27°	56.0	3	QS-PDJNR/L 2020-15C	20.0	20.0	36.0	105.0	25.0	20.0	G 1/8-28	150	5.0	0.30	DNMG 15 06 08
	25 x 25	27°	61.0	3	QS-PDJNR/L 2525-15C	25.0	25.0	36.0	120.0	32.0	25.0	G 1/8-28	150	5.0	0.51	DNMG 15 06 08

R = versão direita, L = versão esquerda

Componentes							
Alavanca	Parafuso	Calço	Rebite elástico	Olhal	Parafuso	Parafuso	Parafuso
174.3-847M	174.3-830	171.35-851M	174.3-861	5691 026-13	5512 104-01	3214 013-01	3214 012-01

Para a lista completa de componentes, acesse www.sandvik.coromant.com



A

TORNEAMENTO GERAL

Ferramentas externas

Ferramenta convencional T-Max® P QS para torneamento

Fixação por alavanca

Refrigeração de precisão

B

KAPR
PSIR45.0°
45.0°

C

SNMM
 SNMG
 SNMA, SNGA

D

		Dimensões, mm														
		CZC _{MS}	OHX	CNSC	Código para pedido	B	H	HBL	LF	WF	HF	CNT	BAR	NM	KG	MIID
	12	20 x 20	52.7	3	QS-PSSNR/L 2020-12C	20.0	20.0	32.7	101.7	25.0	20.0	G 1/8-28	150	5.0	0.33	SNMG 12 04 08
		25 x 25	56.7	3	QS-PSSNR/L 2525-12C	25.0	25.0	31.7	115.7	32.0	25.0	G 1/8-28	150	5.0	0.54	SNMG 12 04 08

R = versão direita, L = versão esquerda

Componentes

E

Alavanca	Parafuso	Calço	Rebite elástico	Olhal	Parafuso	Parafuso	Parafuso
174.3-841M	174.3-821	174.3-851M	174.3-861	5691 026-13	5512 104-01	3214 013-01	3214 012-01

Para a lista completa de componentes, acesse www.sandvik.coromant.com

F

G

H

A152
 F2
 E1
 G1
 ISO 13399
 H36
 H5

A 216

Ferramentas T-Max® P para usinagem interna

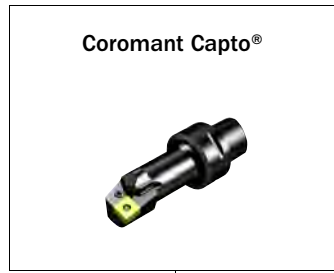

Coromant Capto®

Ferramentas para formatos da pastilha

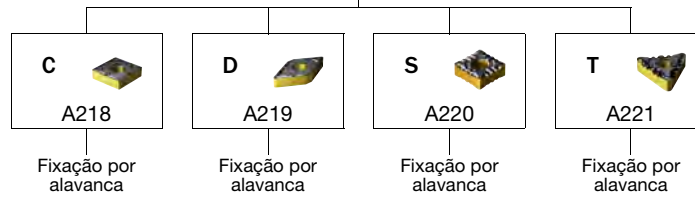

Barra de mandrilar

Ferramentas para formatos da pastilha

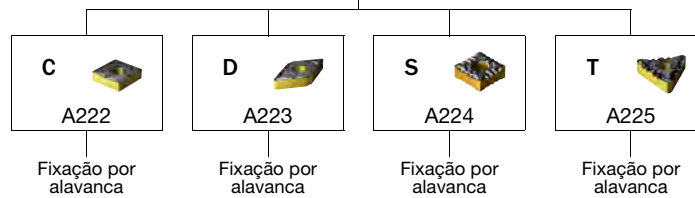

Cabeça de corte CoroTurn® SL

Ferramentas para formatos da pastilha

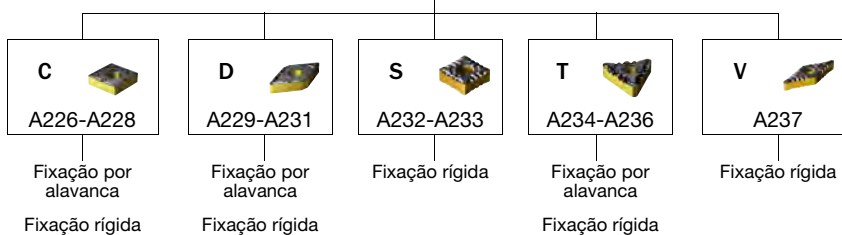

Cabeça de corte CoroTurn® SL para mandrilamento reverso

Ferramentas para formatos da pastilha

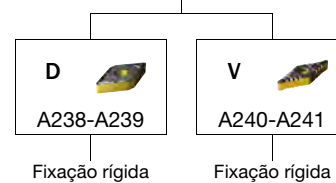

A

TORNEAMENTO GERAL

Ferramentas internas

Unidade de corte T-Max® P para torneamento

Fixação por alavanca

Coromant Capto® - Refrigeração de precisão

KAPR

95.0°

CNMM
 CNMG
 CNMA, CNGA

B

C

D

CZC _{MS}	DMIN ₁	LU	CNSC	Código para pedido	Dimensões, mm				BAR	NM	KG	MIID	
					DCON _{MS}	BD	LF	WF					
09	C4	25.0	51.9	3	C4-PCLNR/L-13080-09HP	40.0	20.0	80.0	13.0	150	2.0	0.41	CNMG 09 03 08
	C5	25.0	50.6	3	C5-PCLNR/L-13080-09HP	50.0	20.0	80.0	13.0	150	2.0	0.61	CNMG 09 03 08
12	C3	32.0	71.8	3	C3-PCLNR/L-17090-12HP	32.0	25.0	90.0	17.0	150	5.0	0.37	CNMG 12 04 08
	C3	40.0	48.0	3	C3-PCLNR/L-22064-12HP	32.0	32.0	64.0	22.0	150	5.0	0.37	CNMG 12 04 08
	C3	40.0	80.0	3	C3-PCLNR-22096-12HP	32.0	32.0	96.0	22.0	150	5.0	0.55	CNMG 12 04 08
	C4	32.0	63.4	3	C4-PCLNR/L-17090-12HP	40.0	25.0	90.0	17.0	150	5.0	0.51	CNMG 12 04 08
	C4	40.0	86.6	3	C4-PCLNR/L-22110-12HP	40.0	32.0	110.0	22.0	150	5.0	0.77	CNMG 12 04 08
	C4	50.0	59.0	3	C4-PCLNR/L-27080-12HP	40.0	40.0	80.0	27.0	150	5.0	0.72	CNMG 12 04 08
	C4	50.0	99.0	3	C4-PCLNR/L-27120-12HP	40.0	40.0	120.0	27.0	150	5.0	1.08	CNMG 12 04 08
	C5	32.0	61.3	3	C5-PCLNR/L-17090-12HP	50.0	25.0	90.0	17.0	150	5.0	0.70	CNMG 12 04 08
	C5	40.0	82.2	3	C5-PCLNR/L-22110-12HP	50.0	32.0	110.0	22.0	150	5.0	0.98	CNMG 12 04 08
	C5	50.0	115.6	3	C5-PCLNR/L-27140-12HP	50.0	40.0	140.0	27.0	150	5.0	1.47	CNMG 12 04 08
E	C5	63.0	79.0	3	C5-PCLNR/L-35100-12HP	50.0	50.0	100.0	35.0	150	5.0	1.43	CNMG 12 04 08
	C6	32.0	67.5	3	C6-PCLNR/L-17100-12HP	63.0	25.0	100.0	17.0	150	5.0	1.13	CNMG 12 04 08
	C6	40.0	78.5	3	C6-PCLNR/L-22110-12HP	63.0	32.0	110.0	22.0	150	5.0	1.34	CNMG 12 04 08
	C6	50.0	109.5	3	C6-PCLNR/L-27140-16HP	63.0	40.0	140.0	27.0	150	5.0	1.79	CNMG 16 06 12
16	C5	63.0	129.0	3	C5-PCLNR/L-35150-16HP	50.0	50.0	150.0	35.0	150	5.0	2.11	CNMG 16 06 12
	C6	63.0	146.7	3	C6-PCLNR/L-35175-16HP	63.0	50.0	175.0	35.0	150	5.0	2.89	CNMG 16 06 12

R = versão direita, L = versão esquerda

F

Componentes					
Código para pedido	Alavanca	Parafuso	Calço	Rebite elástico	Olhal
Cx-PCLNR/L-13xxx-09HP	174.3-845-1	174.3-829			5691 026-13
Cx-PCLNR/L-17xxx-12HP	438.3-841-1	438.3-832M			5691 026-13
Cx-PCLNR/L-22xxx-12HP	174.3-848M	174.3-858	171.31-850M	174.3-861	5691 026-13
Cx-PCLNR/L-27/35xxx-12HP	174.3-841M	174.3-821	171.31-850M	174.3-861	5691 026-13
Cx-PCLNR/L-xxxx-16HP	438.3-840	438.3-831	171.31-852	174.3-864	5691 026-13

Para a lista completa de componentes, acesse www.sandvik.coromant.com

G

H

A152

F2

E1

G1

ISO 13399

H36

H10

H5

A 218

SANDVIK Coromant

Unidade de corte T-Max® P para torneamento

Fixação por alavanca

Coromant Capto® - Refrigeração de precisão

KAPR

93.0°



- DNMM, DNMX
- DNMG
- DNMA, DNGA

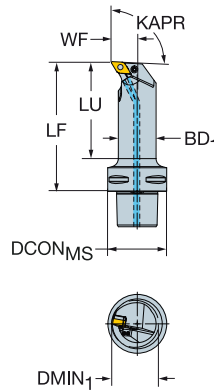

		Dimensões, mm											MIID		
		CZC _{MS}	DMIN ₁	LU	RMPX	CNSC	Código para pedido	DCON _{MS}	BD	LF	WF	BAR		NM	KG
	11	C3	32.0	71.8	27°	3	C3-PDUNR-17090-11HP	32.0	25.0	90.0	17.0	150	2.0	0.37	DNMG 11 04 08
		C4	32.0	63.4	27°	3	C4-PDUNR/L-17090-11HP	40.0	25.0	90.0	17.0	150	2.0	0.50	DNMG 11 04 08
		C4	40.0	86.6	27°	3	C4-PDUNR/L-22110-11HP	40.0	32.0	110.0	22.0	150	2.0	0.77	DNMG 11 04 08
		C5	32.0	61.3	27°	3	C5-PDUNR/L-17090-11HP	50.0	25.0	90.0	17.0	150	2.0	0.70	DNMG 11 04 08
		C5	40.0	82.2	27°	3	C5-PDUNR/L-22110-11HP	50.0	32.0	110.0	22.0	150	2.0	0.98	DNMG 11 04 08
		C6	32.0	67.5	27°	3	C6-PDUNR/L-17100-11HP	63.0	25.0	100.0	17.0	150	2.0	1.12	DNMG 11 04 08
	15	C4	50.0	59.0	27°	3	C4-PDUNR/L-27080-15HP	40.0	40.0	80.0	27.0	150	5.0	0.70	DNMG 15 06 08
		C4	50.0	99.0	27°	3	C4-PDUNR/L-27120-15HP	40.0	40.0	120.0	27.0	150	5.0	1.07	DNMG 15 06 08
		C5	50.0	115.6	27°	3	C5-PDUNR/L-27140-15HP	50.0	40.0	140.0	27.0	150	5.0	1.45	DNMG 15 06 08
		C5	63.0	79.0	27°	3	C5-PDUNR/L-35100-15HP	50.0	50.0	100.0	35.0	150	5.0	1.43	DNMG 15 06 08
		C5	63.0	129.0	27°	3	C5-PDUNR/L-35150-15HP	50.0	50.0	150.0	35.0	150	5.0	2.15	DNMG 15 06 08
		C6	40.0	78.5	27°	3	C6-PDUNR/L-22110-15HP	63.0	32.0	110.0	22.0	150	5.0	1.33	DNMG 15 06 08
		C6	50.0	109.5	27°	3	C6-PDUNR/L-27140-15HP	63.0	40.0	140.0	27.0	150	5.0	1.81	DNMG 15 06 08
		C6	63.0	146.7	27°	3	C6-PDUNR/L-35175-15HP	63.0	50.0	175.0	35.0	150	5.0	2.91	DNMG 15 06 08

R = versão direita, L = versão esquerda

Código para pedido	Componentes				
	Alavanca	Parafuso	Calço	Rebite elástico	Olhal
Cx-PDUNR/L-17xxx-11HP	5432 015-021	438.3-830			5691 026-13
Cx-PDUNR/L-22xxx-11HP	5432 001-01	174.3-820M	5322 255-01	174.3-860	5691 026-13
Cx-PDUNR/L-xxxx-15HP	174.3-847M	174.3-830	171.35-851M	174.3-861	5691 026-13

Para a lista completa de componentes, acesse www.sandvik.coromant.com



Unidade de corte T-Max® P para torneamento

Fixação por alavanca

Coromant Capto® - Refrigeração de precisão

KAPR

75.0°



- SNMM
- SNMG
- SNMA, SNGA

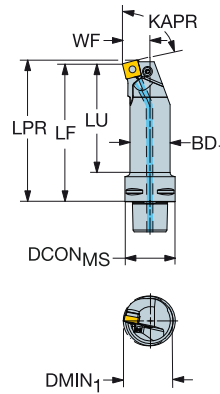

B

C

D

CZC _{MS}	DMIN ₁	LU	RMPX	CNCS	Código para pedido	Dimensões, mm					BAR	NM	KG	MIID	
						DCON _{MS}	BD	LPR	LF	WF					
12	C4	32.0	63.4	10°	3	C4-PSKNR/L-17090-12HP	40.0	25.0	93.1	90.0	17.0	150	5.0	0.51	SNMG 12 04 08
	C4	40.0	86.6	10°	3	C4-PSKNR/L-22110-12HP	40.0	32.0	113.1	110.0	22.0	150	5.0	0.79	SNMG 12 04 08
	C5	32.0	61.3	10°	3	C5-PSKNR/L-17090-12HP	50.0	25.0	93.1	90.0	17.0	150	5.0	0.71	SNMG 12 04 08
	C5	40.0	82.2	10°	3	C5-PSKNR-22110-12HP	50.0	32.0	113.1	110.0	22.0	150	5.0	0.98	SNMG 12 04 08
	C5	50.0	115.6	10°	3	C5-PSKNR-27140-12HP	50.0	40.0	143.1	140.0	27.0	150	5.0	1.49	SNMG 12 04 08
	C6	40.0	78.5	10°	3	C6-PSKNR/L-22110-12HP	63.0	32.0	113.1	110.0	22.0	150	5.0	1.35	SNMG 12 04 08
15	C6	63.0	146.7	10°	3	C6-PSKNR/L-35175-15HP	63.0	50.0	178.8	175.0	35.0	150	5.0	2.96	SNMG 15 06 08

R = versão direita, L = versão esquerda

E

Componentes					
Código para pedido	Alavanca	Parafuso	Calço	Rebite elástico	Olhal
C4-PSKNR/L-17090-12HP	438.3-841-1	438.3-832M			5691 026-13
C4-PSKNR/L-22110-12HP	174.3-848M	174.3-858	174.3-851M	174.3-861	5691 026-13
C5-PSKNR/L-17090-12HP	438.3-841-1	438.3-832M			5691 026-13
C5-PSKNR/L-22110-12HP	174.3-848M	174.3-858	174.3-851M	174.3-861	5691 026-13
C5-PSKNR/L-27140-12HP	174.3-841M	174.3-821	174.3-851M	174.3-861	5691 026-13
C6-PSKNR/L-22110-12HP	174.3-848M	174.3-858	174.3-851M	174.3-861	5691 026-13
C6-PSKNR/L-35175-15HP	438.3-840	438.3-831	174.3-857	174.3-864	5691 026-13

Para a lista completa de componentes, acesse www.sandvik.coromant.com

F

G

H



Unidade de corte T-Max® P para torneamento

Fixação por alavanca

Coromant Capto® - Refrigeração de precisão

KAPR

91.0°



- TNMM, TNMX
- TNMG
- TNMA, TNGA

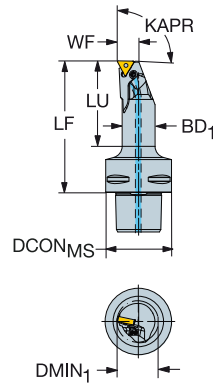

B

C

		Dimensões, mm												
			DMIN1	LU	CNSC	Código para pedido	DCONMS	BD	LF	WF				MIID
	11	C4	32.0	51.9	3	C4-PTFNR/L-13080-11HP	40.0	20.0	80.0	13.0	150	1.2	0.41	TNMG 11 03 04

D

R = versão direita, L = versão esquerda

Componentes		
Alavanca	Parafuso	Olhal
174.3-846-1	174.3-829	5691 026-23

Para a lista completa de componentes, acesse www.sandvik.coromant.com

E

F

G

H



Barra de mandrilar T-Max® P para torneamento

Fixação por alavanca

Cilíndrica com planos - Refrigeração de precisão

B



KAPR

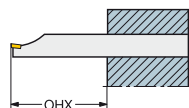

95.0°

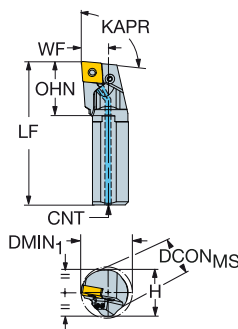

C



- CNMM
- CNMG
- CNMA, CNGA

D

Código para pedido	Dimensões, mm						Código para pedido	Dimensões, mm						MIID		
	CZC _{MS}	DMIN ₁	OHX	OHN	CNSC	DCON _{MS}		H	BD	LF	WF	CNT	BAR		NM	KG
09	16	26.0	64.0	37.8	1	A16R-PCLNR/L09HP	16.0	15.0	16.0	200.0	11.0	G 1/8-28	275	2.0	0.28	CNMG 09 03 08
	20	25.0	80.0	34.6	1	A20S-PCLNR/L09HP	20.0	18.0	20.0	250.0	13.0	G 1/8-28	275	2.0	0.55	CNMG 09 03 08
12	25	32.0	100.0	37.6	1	A25T-PCLNR/L12HP	25.0	23.0	25.0	300.0	17.0	G 1/8-28	275	5.0	0.97	CNMG 12 04 08
	32	40.0	128.0	38.8	1	A32T-PCLNR/L12HP	32.0	30.0	32.0	300.0	22.0	G 1/8-28	275	5.0	1.69	CNMG 12 04 08
40	50.0	160.0	38.8	1	A40T-PCLNR/L12HP	40.0	37.0	40.0	300.0	27.0	G 1/8-28	275	5.0	2.69	CNMG 12 04 08	
19	50	63.0	200.0	45.6	1	A50U-PCLNR/L19HP	50.0	47.0	50.0	350.0	35.0	G 1/8-28	275	10.0	5.03	CNMG 19 06 12

R = versão direita, L = versão esquerda

E

Componentes					
Código para pedido	Alavanca	Parafuso	Calço	Rebite elástico	Olhal
A16R-PCLNR/L09HP	174.3-845-1	174.3-829			5691 026-13
A20S-PCLNR/L09HP	174.3-845-1	174.3-829			5691 026-13
A25T-PCLNR/L12HP	438.3-841-1	438.3-832M			5691 026-13
A32T-PCLNR/L12HP	174.3-848M	174.3-858	171.31-850M	174.3-861	5691 026-13
A40T-PCLNR/L12HP	174.3-848M	174.3-858	171.31-850M	174.3-861	5691 026-13
A50U-PCLNR/L19HP	174.3-849M	174.3-822M	171.31-851M	174.3-868	5691 026-13

Para a lista completa de componentes, acesse www.sandvik.coromant.com

F

G

H



Barra de mandrilar T-Max® P para torneamento

Fixação por alavanca

Cilíndrica com planos - Refrigeração de precisão



- DNMM, DNMX
- DNMG
- DNMA, DNGA

KAPR

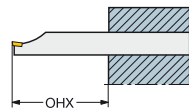

93.0°

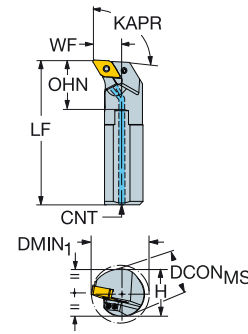

Código para pedido	CZC _{MS}	DMIN ₁	RMPX	OHX	OHN	CNSC	Código para pedido	Dimensões, mm							MIID		
								DCON _{MS}	H	BD	LF	WF	CNT	BAR		NM	KG
A25T-PDUNR/L11HP	11	25	32.0	27°	100.0	37.7	A25T-PDUNR/L11HP	25.0	23.0	25.0	300.0	17.0	G 1/8-28	275	2.0	0.95	DNMG 11 04 08
	32	40.0	27°	128.0	36.2	1	A32T-PDUNR/L11HP	32.0	30.0	32.0	300.0	22.0	G 1/8-28	275	2.0	1.68	DNMG 11 04 08
A40T-PDUNR/L15HP	15	40	50.0	27°	160.0	40.6	A40T-PDUNR/L15HP	40.0	37.0	40.0	300.0	27.0	G 1/8-28	275	5.0	2.67	DNMG 15 06 08
	50	63.0	27°	200.0	40.6	1	A50U-PDUNR/L15HP	50.0	47.0	50.0	350.0	35.0	G 1/8-28	275	5.0	5.03	DNMG 15 06 08

R = versão direita, L = versão esquerda

Código para pedido	Componentes				
	Alavanca	Parafuso	Calço	Rebite elástico	Olhal
A25T-PDUNR/L11HP	5432 015-021	438.3-830			5691 026-13
A32T-PDUNR/L11HP	5432 001-01	174.3-820M	5322 255-01	174.3-860	5691 026-13
A40T-PDUNR/L15HP	174.3-847M	174.3-830	171.35-851M	174.3-861	5691 026-13
A50U-PDUNR/L15HP	174.3-847M	174.3-830	171.35-851M	174.3-861	5691 026-13

Para a lista completa de componentes, acesse www.sandvik.coromant.com



Barra de mandrilar T-Max® P para torneamento

Fixação por alavanca

Cilíndrica com planos - Refrigeração de precisão

B



KAPR

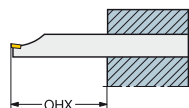

75.0°

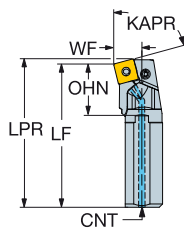

C



- SNMM
- SNMG
- SNMA, SNGA

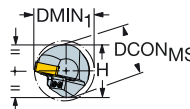

D

Código para pedido	Dimensões, mm						Círculos			MID						
	CZC _{MS}	DMIN ₁	OHX	OHN	CNSC	DCON _{MS}	H	BD	LPR		LF	WF	CNT	BAR	NM	KG
A25T-PSKNR/L12HP	25	32.0	100.0	35.2	1	25.0	23.0	25.0	303.1	300.0	17.0	G 1/8-28	275	5.0	0.97	SNMG 12 04 08
A32T-PSKNR/L12HP	32	40.0	128.0	34.3	1	32.0	30.0	32.0	303.1	300.0	22.0	G 1/8-28	275	5.0	1.71	SNMG 12 04 08
A40T-PSKNR/L12HP	40	50.0	160.0	34.3	1	40.0	37.0	40.0	303.1	300.0	27.0	G 1/8-28	275	5.0	2.71	SNMG 12 04 08
A50U-PSKNR/L19HP	50	63.0	200.0	40.3	1	50.0	47.0	50.0	354.6	350.0	35.0	G 1/8-28	275	10.0	5.34	SNMG 19 06 12

R = versão direita, L = versão esquerda

E

Código para pedido	Componentes				
	Alavanca	Parafuso	Calço	Rebite elástico	Olhal
A25T-PSKNR/L12HP	438.3-841-1	438.3-832M			5691 026-13
A32T-PSKNR/L12HP	174.3-841M	174.3-821	174.3-851M	174.3-861	5691 026-13
A40T-PSKNR/L12HP	174.3-841M	174.3-821	174.3-851M	174.3-861	5691 026-13
A50U-PSKNR/L19HP	174.3-849M	174.3-822M	174.3-852M	174.3-862	5691 026-13

Para a lista completa de componentes, acesse www.sandvik.coromant.com

F

G

H



Barra de mandrilar T-Max® P para torneamento

Fixação por alavanca

Cilíndrica com planos - Refrigeração de precisão



- TNMM, TNMX
- TNMG
- TNMA, TNGA

KAPR

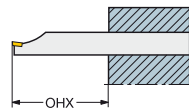

91.0°

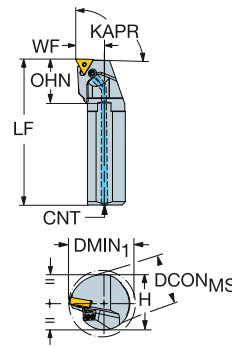

							Código para pedido	Dimensões, mm								MIID
	CZC _{MS}	DMIN ₁	OHX	OHN	CNSC	DCON _{MS}		H	BD	LF	WF	CNT				
11	16	28.0	64.0	30.9	1	A16R-PTFNR/L11HP	16.0	15.0	16.0	200.0	11.0	G 1/8-28	275	1.2	0.29	TNMG 11 03 04
	20	28.0	80.0	30.9	1	A20S-PTFNR11HP	20.0	18.0	20.0	250.0	13.0	G 1/8-28	275	1.2	0.54	TNMG 11 03 04
	25	32.0	100.0	30.9	1	A25T-PTFNR11HP	25.0	23.0	25.0	300.0	17.0	G 1/8-28	275	1.2	0.96	TNMG 11 03 04

R = versão direita, L = versão esquerda

Componentes		
Alavanca	Parafuso	Olhal
174.3-846-1	174.3-829	5691 026-23

Para a lista completa de componentes, acesse www.sandvik.coromant.com



Cabeça T-Max® P

Fixação por alavanca

CoroTurn® SL - Refrigeração de precisão

KAPR

95.0°

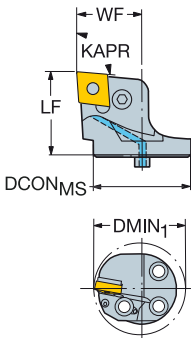
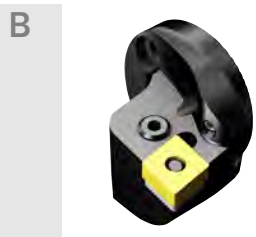

- C
- CNMM
 - CNMG
 - CNMA, CNGA

D

		Dimensões, mm										
		CZC _{MS}	DMIN ₁	CNSC	Código para pedido	DCON _{MS}	LF	WF				MIID
	09	25	34.0	1	SL-PCLNR/L-25-09HP-G	25.0	28.0	19.0	80	1.7	0.08	CNMG 09 03 08
	12	32	40.0	1	SL-PCLNR/L-32-12HP	32.0	36.0	22.0	80	5.0	0.16	CNMG 12 04 08
	40	40	50.0	1	SL-PCLNR/L-40-12HP	40.0	35.0	27.0	80	5.0	0.21	CNMG 12 04 08
	16	40	56.0	1	SL-PCLNR/L-40-16HP	40.0	42.0	27.0	80	5.0	0.27	CNMG 16 06 08

-G indica principais dimensões alteradas

R = versão direita, L = versão esquerda

E

Componentes						
Código para pedido	Alavanca	Parafuso	Calço	Rebite elástico	Tubo de localização	Olhal
SL-PCLNR/L-25-09HP-G	174.3-845-1	174.3-829			5552 058-02	5691 026-13
SL-PCLNR/L-32-12HP	174.3-848M	174.3-858	171.31-850M	174.3-861	5638 031-01	5691 026-03
SL-PCLNR/L-40-12HP	174.3-841M	174.3-821	171.31-850M	174.3-861	5638 031-01	5691 026-03
SL-PCLNR/L-40-16HP	438.3-840	438.3-831	171.31-852	174.3-864	5638 031-01	5691 026-03

Para a lista completa de componentes, acesse www.sandvik.coromant.com

- H
- A152
 - F2
 - H36
 - H5
 - H2



Cabeça T-Max® P

Fixação rígida

CoroTurn® SL - Refrigeração interna

KAPR

95.0°



- CNMM
- CNMG
- CNMA, CNGA

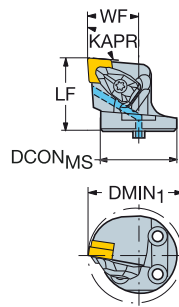

					Dimensões, mm							
	CZC _{MS}	DMIN ₁	CNSC	Código para pedido	DCON _{MS}	LF	WF	BAR	NM	KG	MIID	
	12	32	40.0	1	570-DCLNR/L-32-12-L	32.0	38.0	22.0	10	3.9	0.17	CNMG 12 04 08
		40	50.0	1	570-DCLNR/L-40-12-L	40.0	38.0	27.0	10	3.9	0.22	CNMG 12 04 08
	16	40	57.0	1	570-DCLNR/L-40-16-L	40.0	40.0	32.0	10	6.4	0.32	CNMG 16 06 12
	19	40	57.0	1	570-DCLNR/L-40-19-L	40.0	42.0	34.0	10	6.4	0.33	CNMG 19 06 12

R = versão direita, L = versão esquerda

Código para pedido	Componentes			
	Parafuso do calço	Calço	Jogo de fixação	Tubo de localização
570-DCLNR/L-32-12-L	5513 020-02	5322 236-03	5412 028-021	5638 031-01
570-DCLNR/L-40-12-L	5513 020-02	5322 236-03	5412 028-021	5638 031-01
570-DCLNR/L-40-16-L	5513 020-07	5322 234-03	5412 028-031	5638 031-01
570-DCLNR/L-40-19-L	5513 020-07	5322 236-01	5412 028-041	5638 031-01

Para a lista completa de componentes, acesse www.sandvik.coromant.com



Cabeça T-Max® P

Fixação rígida

CoroTurn® SL Troca Rápida

KAPR

95.0°

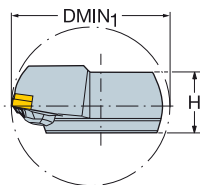
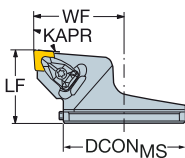

- CNMM
- CNMG
- CNMA, CNGA

			Dimensões, mm								
	CZC _{MS}	DMIN ₁	Código para pedido	DCON _{MS}	H	LF	WF	MIID			
								NM	KG		
	12	80	570-DCLNR/L-80-12	80.0	37.5	45.0	57.0	3.9	0.56	CNMG 12 04 08	
	16	80	570-DCLNR/L-80-16	80.0	37.5	45.0	57.0	6.4	0.60	CNMG 16 06 12	

R = versão direita, L = versão esquerda

Componentes				
Código para pedido	Parafuso do calço	Calço	Jogo de fixação	Parafuso de ajuste
570-DCLNR/L-80-12	5513 020-02	5322 236-03	5412 028-021	5514 060-12
570-DCLNR/L-80-16	5513 020-07	5322 234-03	5412 028-031	5514 060-12

Para a lista completa de componentes, acesse www.sandvik.coromant.com

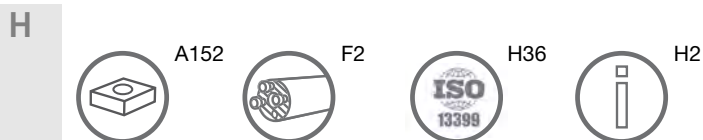

Cabeça T-Max® P

Fixação por alavanca

CoroTurn® SL - Refrigeração de precisão

KAPR

93.0°

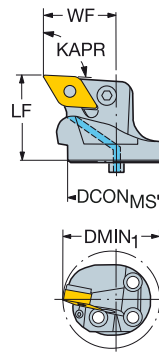

- DNMM, DNMX
- DNMG
- DNMA, DNGA

B

C

							Dimensões, mm						
	CZC _{MS}	DMIN ₁	RMPX	CNSC	Código para pedido	DCON _{MS}	LF	WF	BAR	NM	KG	MIID	
									Ø	Ø	Ø		
	11	25	38.0	27°	1	SL-PDUNR/L-25-11HP-G	25.0	32.0	21.0	80	2.0	0.10	DNMG 11 04 08
		32	40.0	27°	1	SL-PDUNR/L-32-11HP	32.0	32.0	22.0	80	2.0	0.13	DNMG 11 04 08
	15	40	56.0	27°	1	SL-PDUNR/L-40-15HP	40.0	36.0	30.0	80	5.0	0.24	DNMG 15 06 08

D

-G indica principais dimensões alteradas

R = versão direita, L = versão esquerda

Código para pedido	Componentes					
	Alavanca	Parafuso	Calço	Rebite elástico	Tubo de localização	Olhal
SL-PDUNR/L-25-11HP-G	5432 015-021	438.3-830			5552 058-02	5691 026-13
SL-PDUNR/L-32-11HP	5432 001-01	174.3-820M	5322 255-01	174.3-860	5638 031-01	5691 026-03
SL-PDUNR/L-40-15HP	174.3-847M	174.3-830	171.35-851M	174.3-861	5638 031-01	5691 026-03

Para a lista completa de componentes, acesse www.sandvik.coromant.com

E

F

G

H



Cabeça T-Max® P

Fixação rígida

CoroTurn® SL - Refrigeração interna

B

KAPR

570-DDXNR/L
62.5°

570-DDUNR/L
93.0°

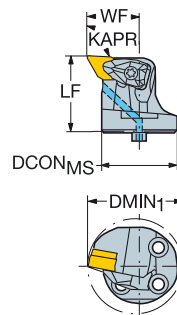
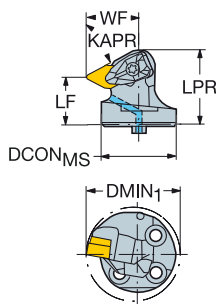

C



- DNMM, DNMX
- DNMG
- DNMA, DNGA

D

CZC _{MS}	DMIN ₁	RMPX	CNSC	Código para pedido	Dimensões, mm							MID	
					DCON _{MS}	LPR	LF	WF	BAR	NM	KG		
11	32	40.0	27°	1	570-DDUNR/L-32-11	32.0	32.0	22.0	10	1.7	0.13	DNMG 11 04 08	
15	40	50.0	27°	1	570-DDUNR/L-40-15	40.0	32.0	27.0	10	3.9	0.21	DNMG 15 06 08	
11	32	40.0	60°	1	570-DDXNR/L-32-11	32.0	31.1	20.0	22.0	10	1.7	0.12	DNMG 11 04 08
15	40	50.0	60°	1	570-DDXNR/L-40-15-L	40.0	36.0	22.0	27.0	10	3.9	0.22	DNMG 15 06 08

E

R = versão direita, L = versão esquerda

Código para pedido	Componentes			
	Parafuso do calço	Calço	Jogo de fixação	Tubo de localização
570-DDUNR/L-32-11	5513 020-04	5322 267-01	5412 028-011	5638 031-01
570-DDXNR/L-32-11	5513 020-04	5322 267-01	5412 028-011	5638 031-01
570-DDUNR/L-40-15	5513 020-02	5322 266-02	5412 028-021	5638 031-01
570-DDXNR/L-40-15-L	5513 020-02	5322 266-02	5412 028-021	5638 031-01

F

Para a lista completa de componentes, acesse www.sandvik.coromant.com

G

H



Cabeça T-Max® P

Fixação rígida

CoroTurn® SL Troca Rápida

KAPR

570-DDXNR/L-80
62.5°

570-DDUNR/L-80
93.0°



- DNMM, DNMX
- DNMG
- DNMA, DNGA

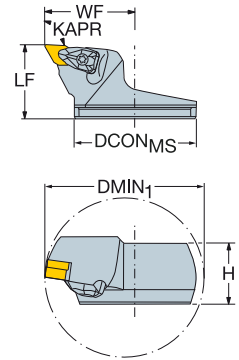
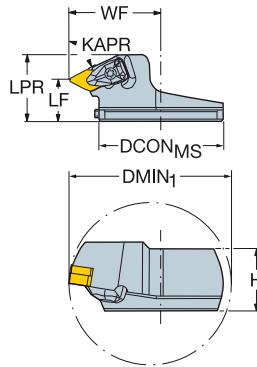

B

C

		Dimensões, mm											
		CZC _{MS}	DMIN ₁	RMPX	Código para pedido	DCON _{MS}	H	LPR	LF	WF			MIID
	15	80	100.0	27°	570-DDUNR/L-80-15	80.0	37.5	45.0	57.0	3.9	0.55		DNMG 15 06 08
	15	80	100.0	60°	570-DDXNR/L-80-15	80.0	37.5	40.3	25.0	57.0	3.9	0.50	DNMG 15 06 08

R = versão direita, L = versão esquerda

D

E

Componentes			
Parafuso do calço	Calço	Jogo de fixação	Parafuso de ajuste
5513 020-02	5322 266-02	5412 028-021	5514 060-12

Para a lista completa de componentes, acesse www.sandvik.coromant.com

F

G



H

A

TORNEAMENTO GERAL

Ferramentas internas

Cabeça T-Max® P

Fixação rígida

CoroTurn® SL - Refrigeração interna

KAPR

75.0°

B

C

SNMM

SNMG

SNMA, SNGA

D

	CZC _{MS}	DMIN ₁	RMPX	CNSC	Código para pedido	Dimensões, mm							MIID	
						DCON _{MS}	LPR	LF	WF	BAR	NM	KG		
	12	40	50.0	10°	1	570-DSKNR/L-40-12	40.0	41.1	38.0	27.0	10	3.9	0.27	SNMG 12 04 08
	15	40	55.0	10°	1	570-DSKNR/L-40-15	40.0	40.7	36.0	29.0	10	6.4	0.31	SNMG 15 06 08

R = versão direita, L = versão esquerda

E

Código para pedido	Componentes			
	Parafuso do calço	Calço	Jogo de fixação	Tubo de localização
570-DSKNR/L-40-12	5513 020-02	5322 426-02	5412 028-021	5638 031-01
570-DSKNR/L-40-15	5513 020-07	5322 425-03	5412 028-031	5638 031-01

Para a lista completa de componentes, acesse www.sandvik.coromant.com

F

G

H

A152
 F2
 H36
 H5
 H2

A 232

Cabeça T-Max® P

Fixação rígida

CoroTurn® SL Troca Rápida

KAPR

75.0°

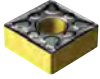

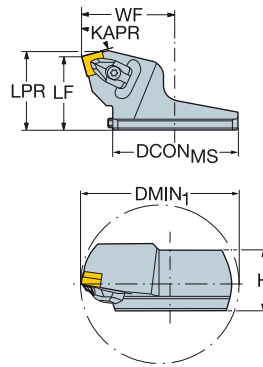

-  SNMM
-  SNMG
-  SNMA, SNGA

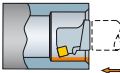

B

C

		Dimensões, mm												
		CZC _{MS}	DMIN ₁	RMPX	Código para pedido	DCON _{MS}	H	LPR	LF	WF	NM	KG	MIID	
		15	80	100.0	10°	570-DSKNR/L-80-15	80.0	37.5	48.1	45.0	57.0	6.4	0.60	SNMG 15 06 12

D

R = versão direita, L = versão esquerda

Componentes			
Parafuso do calço	Calço	Jogo de fixação	Parafuso de ajuste
5513 020-07	5322 425-03	5412 028-031	5514 060-12

Para a lista completa de componentes, acesse www.sandvik.coromant.com

E

F

G



H

Cabeça T-Max® P

Fixação por alavanca

CoroTurn® SL - Refrigeração de precisão

KAPR

91.0°

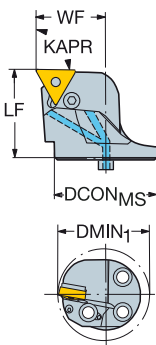

- TNMM, TNMX
- TNMG
- TNMA, TNGA

C

D

				Dimensões, mm								
	CZC _{MS}	DMIN ₁	CNSC	Código para pedido	DCON _{MS}	LF	WF	BAR	NM	KG	MIID	
	16	32	40.0									1
	40	50.0	1	SL-PTFNR/L-40-16HP	40.0	35.0	27.0	80	2.0	0.23	TNMG 16 04 08	

R = versão direita, L = versão esquerda

Componentes					
Alavanca	Parafuso	Calço	Rebite elástico	Tubo de localização	Olhal
174.3-840M	174.3-820M	179.3-850M	174.3-860	5638 031-01	5691 026-03

Para a lista completa de componentes, acesse www.sandvik.coromant.com

F

G

H



Cabeça T-Max® P

Fixação rígida

CoroTurn® SL - Refrigeração interna

KAPR

91.0°

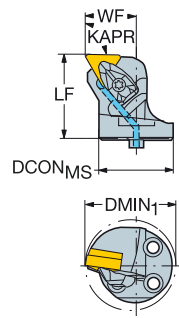

- TNMM, TNMX
- TNMG
- TNMA, TNGA

B

C

		Dimensões, mm										
		CZC_{MS}	$DMIN_1$	CNSC	Código para pedido	$DCON_{MS}$	LF	WF				MIID
	16	32	40.0	1	570-DTFNR/L-32-16-L	32.0	36.0	22.0	10	1.7	0.15	TNMG 16 04 08
	40	50.0	1	570-DTFNR/L-40-16-L	40.0	36.0	27.0	10	1.7	0.23	TNMG 16 04 08	

R = versão direita, L = versão esquerda

Componentes			
Parafuso do calço	Calço	Jogo de fixação	Tubo de localização
5513 020-04	5322 316-01	5412 028-011	5638 031-01

Para a lista completa de componentes, acesse www.sandvik.coromant.com

D

E

F

G

H



A

Cabeça T-Max® P

Fixação rígida

CoroTurn® SL Troca Rápida

KAPR

91.0°

B

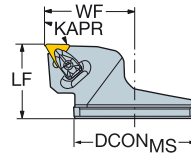

C

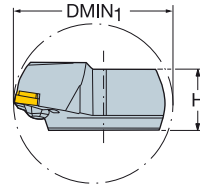

- TNMM, TNMX
- TNMG
- TNMA, TNGA

D

				Dimensões, mm								
		$DMIN_1$	Código para pedido	$DCON_{MS}$	H	LF	WF			MIID		
	16	80	570-DTFNR/L-80-16	80.0	37.5	45.0	57.0	1.7	0.60	TNMG 16 04 08		

R = versão direita, L = versão esquerda

E

Componentes			
Parafuso do calço	Calço	Jogo de fixação	Parafuso de ajuste
5513 020-04	5322 316-01	5412 028-011	5514 060-12

Para a lista completa de componentes, acesse www.sandvik.coromant.com

F

G

H



POB

Cabeça T-Max® P

Fixação rígida

CoroTurn® SL - Refrigeração interna

KAPR

93.0°

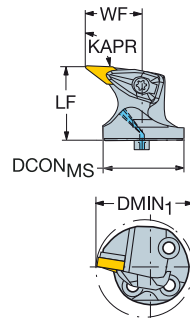

VNMG

		Dimensões, mm										
		DMIN1	RMPX	CNSC	Código para pedido	DCONMS	LF	WF	BAR	NM	KG	MIID
	16	40	52.0	25°	1	570-DVUNR/L-40-16	40.0	36.0	30.0	10	3.0	0.24

R = versão direita, L = versão esquerda

Componentes			
Parafuso do calço	Calço	Jogo de fixação	Tubo de localização
5513 020-09	5322 269-01	5412 028-061	5638 031-01

Para a lista completa de componentes, acesse www.sandvik.coromant.com



Cabeça T-Max® P para mandrilamento reverso

Fixação rígida

CoroTurn® SL - Refrigeração interna

KAPR

93.0°

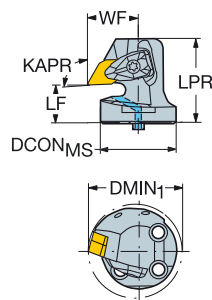

- C
- DNMM, DNMX
 - DNMG
 - DNMA, DNGA

		Dimensões, mm												
		CZC _{MS}	DMIN ₁	RMPX	CNSC	Código para pedido	DCON _{MS}	LPR	LF	WF	BAR	NM	KG	MID
	15	40	50.0	27°	1	570-DDUNR/L-40-15X	40.0	44.7	20.0	27.0	10	3.9	0.28	DNMG 15 06 08

R = versão direita, L = versão esquerda

Componentes

Parafuso do calço	Calço	Jogo de fixação	Tubo de localização
5513 020-02	5322 266-02	5412 028-021	5638 031-01

Para a lista completa de componentes, acesse www.sandvik.coromant.com

- H
- A152
 - F2
 - H36
 - H5
 - H2

Cabeça T-Max® P para mandrilamento reverso

Fixação rígida

CoroTurn® SL Troca Rápida

KAPR

93.0°



- DNMM, DNMX
- DNMG
- DNMA, DNGA

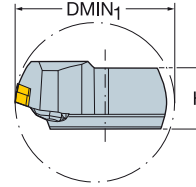
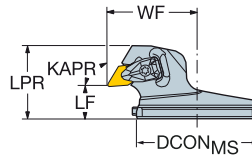

						Dimensões, mm									
		DMIN ₁	RMPX	Código para pedido	DCON _{MS}	H	LPR	LF	WF			MIID			
	15	80	100.0	27°	570-DDUNR/L-80-15X	80.0	37.5	45.0	20.0	57.0	3.9	0.55	DNMG 15 06 08		
														R = versão direita, L = versão esquerda	

Componentes			
Parafuso do calço	Calço	Jogo de fixação	Parafuso de ajuste
5513 020-02	5322 266-02	5412 028-021	5514 060-12

Para a lista completa de componentes, acesse www.sandvik.coromant.com



Cabeça T-Max® P para mandrilamento reverso

Fixação rígida

CoroTurn® SL - Refrigeração interna

KAPR

93.0°

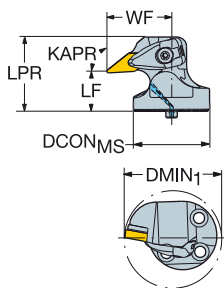

VNMG

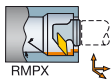
		Dimensões, mm													
		CZC _{MS}	DMIN ₁	RMPX	CNSC	Código para pedido	DCON _{MS}	LPR	LF	WF	BAR	NM	KG	MID	
		16	40	56.0	25°	1	570-DVUNR/L-40-16X	40.0	38.5	20.0	34.0	10	3.0	0.26	VNMG 16 04 08

R = versão direita, L = versão esquerda

Componentes			
Parafuso do calço	Calço	Jogo de fixação	Tubo de localização
5513 020-09	5322 269-01	5412 028-061	5638 031-01

Para a lista completa de componentes, acesse www.sandvik.coromant.com



Cabeça T-Max® P para mandrilamento reverso

Fixação rígida

CoroTurn® SL Troca Rápida

KAPR

93.0°



VNMG

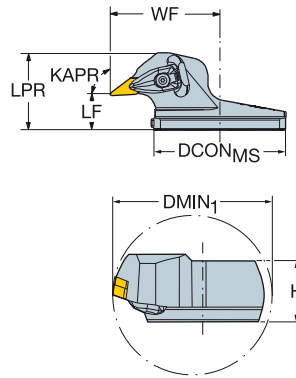

		Dimensões, mm											
		CZC _{MS}	DMIN ₁	RMPX	Código para pedido	DCON _{MS}	H	LPR	LF	WF	NM	KG	MIID
		16	80	100.0	30°	570-DVUNR/L-80-16X	80.0	37.5	45.0	20.0	64.0	3.0	0.55

R = versão direita, L = versão esquerda

Componentes			
Parafuso do calço	Calço	Jogo de fixação	Parafuso de ajuste
5513 020-09	5322 269-01	5412 028-061	5514 060-12

Para a lista completa de componentes, acesse www.sandvik.coromant.com



T-Max® e T-Max® S

Para usinagem de materiais avançados

Aplicação

- Torneamento longitudinal
- Faceamento
- Perfilamento
- Desbaste ao acabamento

Área de aplicação ISO:



Características e benefícios

Solução produtiva com as tecnologias Wiper e Xcel

- Usinagem confiável e segura, mesmo em aplicações de desbaste
- Pastilhas dupla face com arestas robustas
- Fixação segura e rígida e fixação por grampo superior



Fixação

- T-Max® : Fixação rígida, fixação por grampo superior
- T-Max® S: fixação por grampo superior

Ferramentas

- Unidades de corte Coromant Capto®
- Ferramentas convencionais
- Barras de mandrilar
- Cabeças CoroTurn® SL

Pastilhas

- Os suportes T-Max e T-max S usam pastilhas T-Max, sem furos.

G Materiais de corte avançados

Cerâmicas

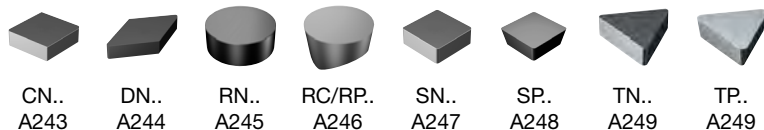

Diamante policristalino (PCD)



Pastilha T-Max® para torneamento

Pastilha tipo C (rômbica 80°)

Materiais de corte avançados

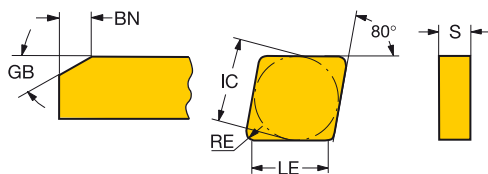
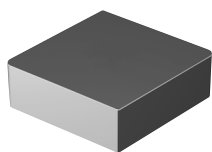

	LE	S	RE	GB	BN	CÓDIGO ISO	K		S				H				
							6190	650	7925	6060	6065	6160	650	670	650	670	
Acabamento	12	12.1	4.76	0.8	20°	0.10	CNGN120408T01020	★									
		11.7	4.76	1.2	20°	0.25	CNGN120412S02520M		★								
		11.7	4.76	1.2	20°	0.10	CNGN120412T01020						★		★		
		11.7	4.76	1.2	20°	0.25	CNGN120412T02520	★	☆				☆	★	★	☆	
		11.3	4.76	1.6	20°	0.25	CNGN120416S02520M			★							
		11.3	4.76	1.6	20°	0.10	CNGN120416T01020		★				☆	★	★	☆	
		11.7	7.94	1.2	20°	0.25	CNGN120712T02520	★	☆				★		★		
		11.3	7.94	1.6	20°	0.25	CNGN120716T02520	★									
Média	16	15.3	7.94	0.8	20°	0.10	CNGN160708T01020		★				★		★		
		14.9	7.94	1.2	20°	0.10	CNGN160712T01020		★				☆	★	★	☆	
	12	12.1	7.94	0.8	20°	0.10	CNGN120708T01020		★				☆	★	★	☆	
		11.7	7.94	1.2	20°	0.10	CNGN120712T01020		★		☆			☆	★	★	☆
		11.3	7.94	1.6	20°	0.10	CNGN120716T01020		★				☆	★	★	☆	
	11.7	7.94	1.2			CNGN120712E					☆	★					



A262



A268



A278



A294



H36



H6



H3



A

TORNEAMENTO GERAL

Pastilhas

Pastilha T-Max® para torneamento

Pastilha tipo D (rômbica 55°)

Materiais de corte avançados

B

C

	LE	S	RE	GB	BN	CÓDIGO ISO	K	S	H	
							650	650	650	
Acabamento	15	14.7	4.76	0.8	20°	0.10	DNGN150408T01020	★	★	★
	14.3	4.76	1.2	20°	0.10	DNGN150412T01020		★	★	
	14.7	7.94	0.8	20°	0.10	DNGN150708T01020	★	★	★	
	14.3	7.94	1.2	20°	0.10	DNGN150712T01020	★	★	★	
	13.9	7.94	1.6	20°	0.10	DNGN150716T01020	★	★	★	

D

E

F

G

H

A262

A268

A278

A294

H36

H6

H3

A 244

POR

Pastilha T-Max® para torneamento

Pastilha tipo R (redonda)

Materiais de corte avançados

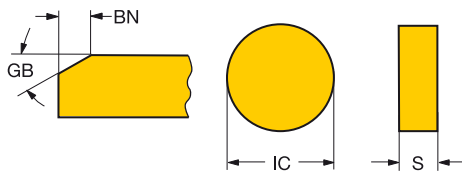

	S	RE	GB	BN	CÓDIGO ISO	K		S						H					
						6190	650	7925	6060	6065	6160	6220	6230	650	670	650	670		
Acabamento	06	3.18	3.0	20°	0.25	RNGN060300S02520M			*										
	09	3.18	4.8	20°	0.25	RNGN090300S02520M			*										
		3.18	4.8	20°	0.10	RNGN090300T01020			*					*	*	*	*	*	*
	12	3.18	6.4	20°	0.25	RNGN120300S02520M			*										
		4.76	6.4	20°	0.25	RNGN120400S02520M			*										
			6.4	20°	0.10	RNGN120400T01020			*					*	*	*	*	*	*
		4.76	6.4	20°	0.25	RNGN120400T02520		*						*	*	*	*	*	*
		7.94	6.4	15°	1.50	RNGN120700K15015		*	*					*	*	*	*	*	*
		7.94	6.4	20°	0.25	RNGN120700T02520		*	*					*	*	*	*	*	*
	15	7.94	6.4	15°	1.50	RNGN120700T15015		*	*					*	*	*	*	*	*
		7.94	7.9	20°	0.10	RNGN150700T01020		*	*					*	*	*	*	*	*
			7.9	20°	0.25	RNGN150700T02520		*	*					*	*	*	*	*	*
	19	7.94	7.9	15°	2.00	RNGN150700T20015		*	*					*	*	*	*	*	*
		7.94	9.5	15°	2.00	RNGN190700K20015		*	*					*	*	*	*	*	*
Média	09	3.18	4.8			RNGN090300E			*										
	12	7.94	6.4	20°	0.10	RNGN120700T01020		*	*	*	*	*	*	*	*	*	*	*	
		4.76	6.4			RNGN120400E		*	*	*	*	*	*	*	*	*	*	*	
	7.94	6.4			RNGN120700E		*	*	*	*	*	*	*	*	*	*	*	*	
	19	7.94	9.5	20°	0.10	RNGN190700T01020		*	*	*	*	*	*	*	*	*	*	*	*
		7.94	9.5			RNGN190700E		*	*	*	*	*	*	*	*	*	*	*	*



A

TORNEAMENTO GERAL

Pastilhas

Pastilha T-Max® para torneamento

Pastilha tipo R (redonda)

Materiais de corte avançados

B



RCGX..K/T

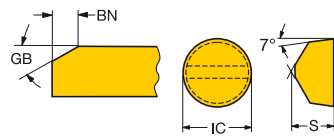

RPGN..S/T

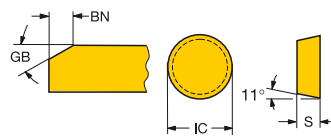

RPGX..S/T

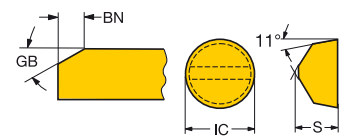

C

	S	RE	GB	BN	CÓDIGO ISO	K						S		H					
						650	6060	6065	6160	6220	6230	650	670	650	670				
Acabamento	09	7.94	4.8	15°	0.70	RCGX090700T07015	★												
		3.18	4.8	20°	0.10	RPGN090300T01020												★	
	12	7.94	6.4	15°	1.50	RCGX120700K15015	★												
		7.94	6.4	20°	0.25	RCGX120700T02520	★												
		7.94	6.4	15°	1.50	RCGX120700T15015	★												
	15	10.00	7.9	15°	2.00	RCGX151000T20015	★												
Média	19	10.00	9.5	15°	2.00	RCGX191000K20015	★												
		10.00	9.5	15°	2.00	RCGX191000T20015	★												
	06	6.35	3.2	20°	0.10	RCGX060600T01020	★				☆	☆	☆	☆	☆	☆	☆	☆	
		6.35	3.2			RCGX060600E	★	☆	☆	☆									☆
		3.18	3.2			RPGN060300E		☆		★									
		4.76	3.2			RPGX060400E				★									
Média	09	7.94	4.8	20°	0.10	RCGX090700T01020	★	☆			☆	☆	☆	☆	☆	☆	☆	☆	
		7.94	4.8	20°	0.10	RPGX090700T01020		☆			☆	☆	☆	☆	☆	☆	☆	☆	
		7.94	4.8			RCGX090700E	★	☆	☆	☆									☆
		3.18	4.8			RPGN090300E		☆		★									
		7.94	4.8			RPGX090700E		☆		★									
		7.94	4.8			RCMX 09 07 00-SM				★									
	12	7.94	6.4	20°	0.10	RCGX120700T01020	★	☆			☆	☆	☆	☆	☆	☆	☆	☆	
		7.94	6.4	20°	0.10	RPGX120700T01020		☆			☆	☆	☆	☆	☆	☆	☆	☆	
		7.94	6.4			RCGX120700E		☆	☆	☆									★
	4.76	6.4			RPGN120400E		☆		★										
	7.94	6.4			RPGX120700E		☆		★										

E

F

G

H



A262



A268

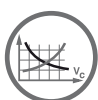

A278



A294



H36



H6



H3

Pastilha T-Max® para torneamento

Pastilha tipo S (quadrada)

Materiais de corte avançados

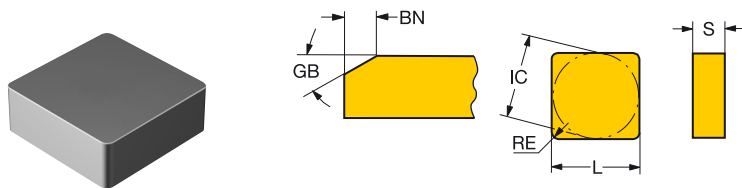

	LE	S	RE	GB	BN	CÓDIGO ISO	K			S				H		
							6190	650	7925	6060	6065	6160	650	670	650	670
Acabamento	09	8.7	3.18	0.8	20°	0.10	SNGN090308T01020	*					*	*	*	*
		8.3	3.18	1.2	20°	0.25	SNGN090312S02520M		*							
		8.3	3.18	1.2	20°	0.10	SNGN090312T01020	*					*	*	*	*
	12	11.1	4.76	1.6	20°	0.10	SNGN120416T01020	*					*	*	*	*
		11.9	4.76	0.8	20°	0.10	SNGN120408T01020	*					*	*	*	*
		11.9	4.76	0.8	20°	0.25	SNGN120408T02520	*					*	*	*	*
		11.5	4.76	1.2	20°	0.25	SNGN120412S02520M		*							
		11.5	4.76	1.2	20°	0.10	SNGN120412T01020	*	*				*	*	*	*
		11.5	4.76	1.2	20°	0.25	SNGN120412T02520	*	*				*	*	*	*
		11.1	4.76	1.6	20°	0.25	SNGN120416S02520M			*						
		11.1	4.76	1.6	20°	0.25	SNGN120416T02520	*	*				*	*	*	*
		11.9	7.94	0.8	20°	0.10	SNGN120708T01020	*	*				*	*	*	*
		11.5	7.94	1.2	20°	0.25	SNGN120712T02520	*	*				*	*	*	*
		11.1	7.94	1.6	15°	1.50	SNGN120716K15015	*	*				*	*	*	*
		11.1	7.94	1.6	20°	0.10	SNGN120716T01020	*	*				*	*	*	*
		11.1	7.94	1.6	20°	0.25	SNGN120716T02520	*	*				*	*	*	*
		11.1	7.94	1.6	15°	1.50	SNGN120716T15015	*	*				*	*	*	*
		11.5	4.76	1.2			SNGN120412E				*					
	15	15.1	7.94	0.8	20°	0.10	SNGN150708T01020	*	*				*	*	*	*
		14.7	7.94	1.2	20°	0.10	SNGN150712T01020						*	*	*	*
	14.3	7.94	1.6	20°	0.10	SNGN150716T01020	*	*				*	*	*	*	
	14.3	7.94	1.6	20°	0.25	SNGN150716T02520	*	*				*	*	*	*	
19	17.5	7.94	1.6	20°	0.10	SNGN190716T01020	*	*				*	*	*	*	
	16.7	7.94	2.4	20°	0.10	SNGN190724T01020	*	*				*	*	*	*	
Média	12	11.5	7.94	1.2	20°	0.10	SNGN120712T01020	*	*	*		*	*	*	*	
		11.5	7.94	1.2			SNGN120712E			*	*	*	*	*	*	
		11.1	7.94	1.6			SNGN120716E			*	*	*	*	*	*	
	19	17.4	7.94	1.6			SNGN190716E			*	*	*	*	*	*	
		16.7	7.94	2.4			SNGN190724E			*	*	*	*	*	*	



A262



A268



A278



A294



H36



H6



H3

A

Pastilha T-Max® para torneamento

Pastilha tipo S (quadrada)

Materiais de corte avançados

B

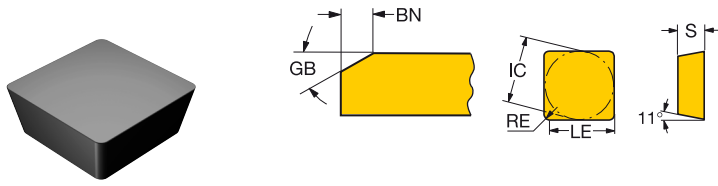

C

Acabamento		LE	S	RE	GB	BN	CÓDIGO ISO	K	S	H
	12	11.9	4.76	0.8	20°	0.10	SPGN120408T01020	650	650	650
								*	*	*

D

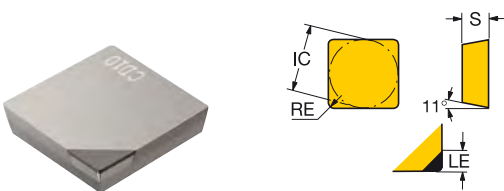

E

Acabamento		LE	S	RE	CÓDIGO ISO	N
	12	4.6	3.18	0.4	SPUN120304FP	CD10
						*

F

G

H



Pastilha T-Max® para torneamento

Pastilha tipo T (triangular)

Materiais de corte avançados

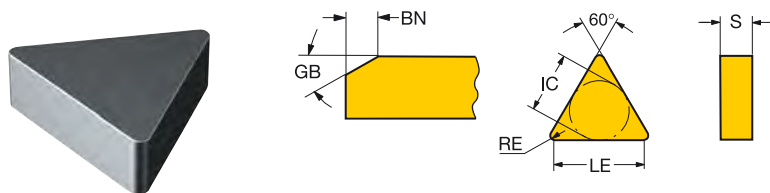

Acabamento	LE	S	RE	GB	BN	CÓDIGO ISO	K		S		H	
							650	670	650	670	650	670
11	10.2	3.18	0.79	20°	0.10	TNGN110308T01020	*	*	*	*	*	*
16	15.7	4.76	0.79	20°	0.10	TNGN160408T01020	*	*	*	*	*	*
	15.3	4.76	1.19	20°	0.10	TNGN160412T01020	*	*	*	*	*	*
	15.7	7.94	0.79	20°	0.10	TNGN160708T01020	*	*	*	*	*	*
	15.3	7.94	1.19	20°	0.10	TNGN160712T01020	*	*	*	*	*	*
22	21.2	4.76	0.79	20°	0.10	TNGN220408T01020	*	*	*	*	*	*

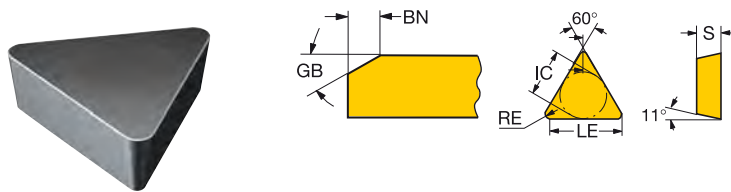

Acabamento	LE	S	RE	GB	BN	CÓDIGO ISO	K		S		H	
							650	670	650	670	650	670
11	10.6	3.18	0.4	20°	0.10	TPGN110304T01020	*	*	*	*	*	*
	10.2	3.18	0.8	20°	0.10	TPGN110308T01020	*	*	*	*	*	*
16	16.1	3.18	0.4	20°	0.10	TPGN160304T01020	*	*	*	*	*	*
	15.7	3.18	0.8	20°	0.10	TPGN160308T01020	*	*	*	*	*	*
	15.3	3.18	1.2	20°	0.10	TPGN160312T01020	*	*	*	*	*	*

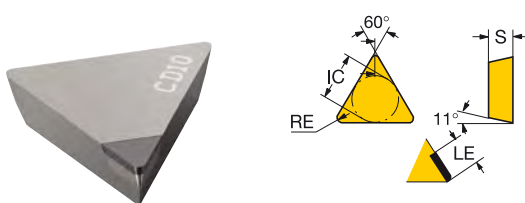

Acabamento	LE	S	RE	CÓDIGO ISO	N
11	2.7	3.18	0.4	TPUN110304FP	*
16	7.4	3.18	0.4	TPUN160304FLP	*
	2.7	3.18	0.4	TPUN160304FP	*
	7.4	3.18	0.4	TPUN160304FRP	*



A

TORNEAMENTO GERAL

Pastilhas

Pastilha T-Max® para canais

B

C

						s Dimensões, mm				
		SSC	CW	REL	RER	Código para pedido	6160	AN	CWTOLL	CWTOLU
Média		06	6.35	0.79	0.79	CSGX060608E	★	11°	-0.025	0.025
		09	9.53	0.79	0.79	CSGX090708E	★	11°	-0.025	0.025
		12	12.70	0.79	0.79	CSGX120708E	★	11°	-0.025	0.025

D

SSC = Para corresponder ao SSC no suporte.

E

F

G

H

A278

H36

A 250

Ferramenta convencional T-Max® para torneamento

Desenho de fixação rígida para pastilhas de cerâmica

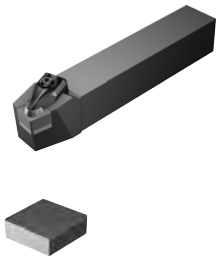

CNG

KAPR

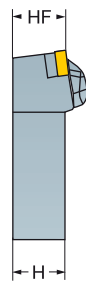

CCBNR/L
75.0°

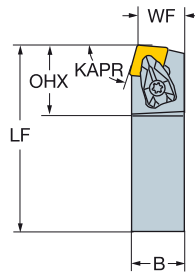

CCLNR/L
95.0°

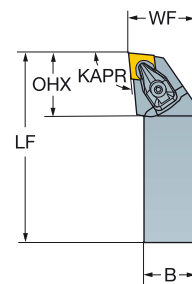

	CZC _{MS}	OHX	Código para pedido	Dimensões, mm								MIID
				B	H	LF	WF	HF	NM	KG		
	25 x 25	34.6	CCBNR/L 2525M 12-4	25.0	25.0	150.0	22.0	25.0	3.0	0.42	CNGN 12 07 08	
	32 x 25	34.6	CCBNR/L 3225P 12-4	25.0	32.0	170.0	22.0	32.0	3.0	1.02	CNGN 12 07 08	
	25 x 25	32.0	CCLNR/L 2525M 12-4	25.0	25.0	150.0	32.0	25.0	3.0	0.79	CNGN 12 07 08	
	32 x 25	32.0	CCLNR/L 3225P 12-4	25.0	32.0	170.0	32.0	32.0	3.0	1.12	CNGN 12 07 08	
	32 x 32	39.0	CCLNR/L 3232P 16-4	32.0	32.0	170.0	40.0	32.0	6.4	1.14	CNGN 16 07 12	

Quando usar pastilhas com 4,76 mm de espessura, calços opcionais devem ser solicitados.

R = versão direita, L = versão esquerda

Componentes				
CZC _{MS}	Calço	Parafuso do calço	Jogo de fixação	
12	5322 234-02	5513 020-02	5412 034-021	
16	5322 234-04	5513 020-07	5412 034-031	

Para a lista completa de componentes, acesse www.sandvik.coromant.com



Ferramenta convencional T-Max® para torneamento

Desenho de fixação rígida para pastilhas de cerâmica

B



KAPR

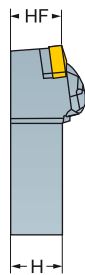

CDJNR/L
93.0°

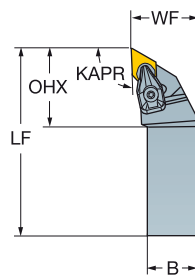

CDNNR/L
62.5°

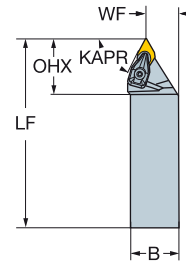

C

DNG

D

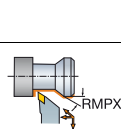

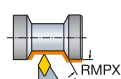
		Dimensões, mm												
		CZC _{MS}	RMPX	OHX	Código para pedido	B	H	LF	WF	HF	NM	KG	MIID	
	15	25 x 25	27°	39.4	CDJNR/L 2525M 15-4	25.0	25.0	150.0	32.0	25.0	3.9	0.62	DNGN 15 07 08	
		32 x 25	27°	39.4	CDJNR/L 3225P 15-4	25.0	32.0	170.0	32.0	32.0	3.9	1.11	DNGN 15 07 08	
		32 x 32	27°	39.4	CDJNR/L 3232P 15-4	32.0	32.0	170.0	40.0	32.0	3.9	1.36	DNGN 15 07 08	
	15	32 x 25	57°	41.2	CDNNR/L 3225P 15-4	25.0	32.0	170.0	13.0	32.0	3.9	1.05	DNGN 15 07 08	

E

Quando usar pastilhas com 4,76 mm de espessura, calços opcionais devem ser solicitados.

R = versão direita, L = versão esquerda

Componentes		
Calço	Parafuso do calço	Jogo de fixação
5322 266-03	5513 020-02	5412 034-021

Para a lista completa de componentes, acesse www.sandvik.coromant.com

F

G

H



Ferramenta convencional T-Max® para torneamento

Desenho de fixação rígida para pastilhas de cerâmica



RCGX
RPGX

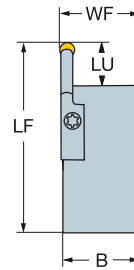
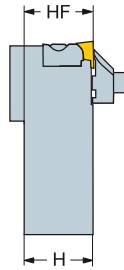

		Dimensões, mm												
		CZC _{MS}	LU	RMPX	OHX	Código para pedido	B	H	LF	WF	HF	NM	KG	MIID
	06	32 x 36	19.4	90°	50.0	R/L176.9-3236-06	36.0	32.0	170.0	36.6	32.0	5.0	1.44	RCGX 06 06 00

Quando usar pastilhas com 4,76 mm de espessura, calços opcionais devem ser solicitados.

R = versão direita, L = versão esquerda

Componentes			
Grampo	Parafuso de fixação	Assento	Parafuso do assento
5412 110-02	3212 036-506	5321 066-01	3212 010-157

Para a lista completa de componentes, acesse www.sandvik.coromant.com



Ferramenta convencional T-Max® para torneamento

Desenho de fixação por grampo para pastilhas de cerâmica

B

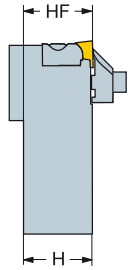

CRDCN

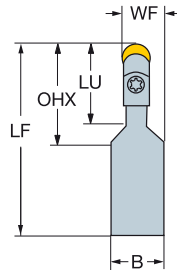

CRDCR/L

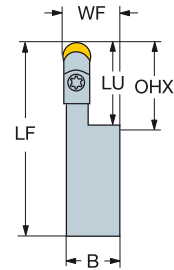

C



RCGX
RPGX

D

CZC _{MS}	LU	RMPX	OHX	Código para pedido	Dimensões, mm					MIID			
					B	H	LF	WF	HF				
06	32 x 25	19.4	90°	170.0	CRDCN 3225P 06-A	25.0	32.0	170.0	15.6	32.0	5.0	1.01	RCGX 06 06 00
09	32 x 25	29.0	90°	29.0	CRDCN 3225P 09-A	25.0	32.0	170.0	17.2	32.0	7.5	0.98	RCGX 09 07 00
12	32 x 25	38.5	90°	38.5	CRDCN 3225P 12-A	25.0	32.0	170.0	18.8	32.0	7.5	1.00	RCGX 12 07 00
09	32 x 25	29.5	90°	29.5	CRDCR/L 3225P 09-A	25.0	32.0	170.0	25.8	32.0	7.5	1.00	RCGX 09 07 00
12	32 x 25	38.5	90°	38.5	CRDCR/L 3225P 12-A	25.0	32.0	170.0	25.9	32.0	7.5	0.98	RCGX 12 07 00

N = neutra, R = versão direita, L = versão esquerda

E

Componentes					
CZC _{MS}	Grampo	Parafuso de fixação	Assento	Parafuso do assento	
06	32 x 25	5412 105-01	3212 036-504	5321 066-01	3212 010-157
09	32 x 25	5412 100-01	3212 035-452	5321 065-01	3212 106-352
12	32 x 25	5412 100-02	3212 036-504	5321 065-02	3212 105-453

Para a lista completa de componentes, acesse www.sandvik.coromant.com

F

G

H



A243



F2



E1



H36



H10

Ferramenta convencional T-Max® para torneamento

Desenho de fixação por grampo para pastilhas de cerâmica



RNG

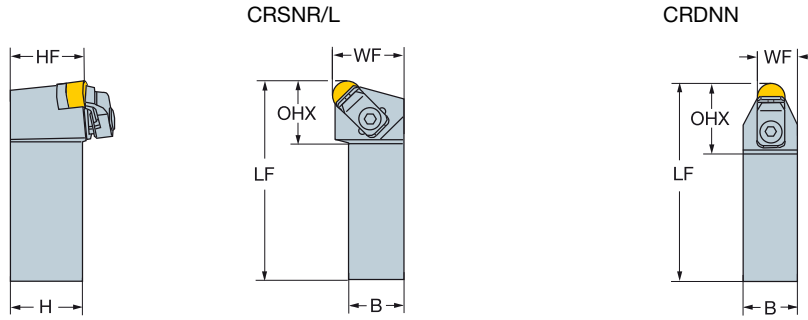

CZC _{MS}	RMPX	OHX	Código para pedido	Dimensões, mm					NM	KG	MIID	
				B	H	LF	WF	HF				
06	25 x 25	0°	29.0	CRDNN 2525M 06-ID	25.0	25.0	151.0	15.7	25.0	7.5	0.78	RNGN 06 03 00
09	25 x 25	0°	30.0	CRDNN 2525M 09-ID	25.0	25.0	150.0	17.3	25.0	7.5	0.73	RNGN 09 03 00
12	25 x 25	0°	32.0	CRDNN 2525M 12-ID	25.0	25.0	150.0	18.8	25.0	7.5	0.70	RNGN 12 07 00
	32 x 25	0°	36.4	CRDNN 3225P 1203-ID	25.0	32.0	170.0	32.0	32.0	7.5	1.06	RNGN 12 03 00
32 x 25	0°	32.0	32.0	CRDNN 3225P 12-ID	25.0	32.0	170.0	18.8	32.0	7.5	1.06	RNGN 12 07 00
				CRDNN 3232P 15-ID	32.0	32.0	170.0	23.9	32.0	7.5	1.30	RNGN 15 07 00
15	32 x 32	0°	35.0	CRDNN 3232P 15-ID	32.0	32.0	170.0	23.9	32.0	7.5	1.30	RNGN 15 07 00
19	32 x 32	0°	38.0	CRDNN 3232P 19-ID	32.0	32.0	170.0	25.5	32.0	7.5	1.32	RNGN 19 07 00
06	25 x 25	0°	26.7	CRSNR/L 2525M 06-ID	25.0	25.0	151.0	32.2	25.0	7.5	0.78	RNGN 06 03 00
09	25 x 25	12°	28.0	CRSNR/L 2525M 09-ID	25.0	25.0	150.0	32.0	25.0	7.5	0.80	RNGN 09 03 00
12	25 x 25	12°	28.0	CRSNR/L 2525M 12-ID	25.0	25.0	150.0	32.0	25.0	7.5	0.79	RNGN 12 07 00
	32 x 25	0°	30.7	CRSNR/L 3225P 1203-ID	25.0	32.0	170.0	32.0	32.0	7.5	1.10	RNGN 12 03 00
32 x 25	12°	28.0	28.0	CRSNR/L 3225P 12-ID	25.0	32.0	170.0	32.0	32.0	7.5	1.14	RNGN 12 07 00
				CRSNR/L 3232P 15-ID	32.0	32.0	170.0	40.0	32.0	7.5	1.41	RNGN 15 07 00
15	32 x 32	12°	30.0	CRSNR/L 3232P 15-ID	32.0	32.0	170.0	40.0	32.0	7.5	1.41	RNGN 15 07 00
19	32 x 32	12°	32.0	CRSNR/L 3232P 19-ID	32.0	32.0	170.0	40.0	32.0	7.5	1.42	RNGN 19 07 00

Quando usar pastilhas com 4,76 mm de espessura, calços opcionais devem ser solicitados.

N = neutra, R = versão direita, L = versão esquerda

Componentes					
CZC _{MS}	Grampo	Placa de pressão	Calço	Parafuso do calço	
06	25 x 25	5412 125-03	5192 020-02	5322 141-06	5512 031-15
09	25 x 25	5412 127-01	5192 020-01	5321 215-01	3212 100-206
12	25 x 25-32 x 25	5412 125-01	5192 020-01	5322 141-01	5513 013-02
15	32 x 32	5412 125-01	5192 020-01	5321 215-02	3212 100-206
19	32 x 32	5412 125-01	5192 020-01	5321 215-03	3212 100-257

Para a lista completa de componentes, acesse www.sandvik.coromant.com



Ferramenta convencional T-Max® para torneamento

Desenho de fixação rígida para pastilhas de cerâmica

B

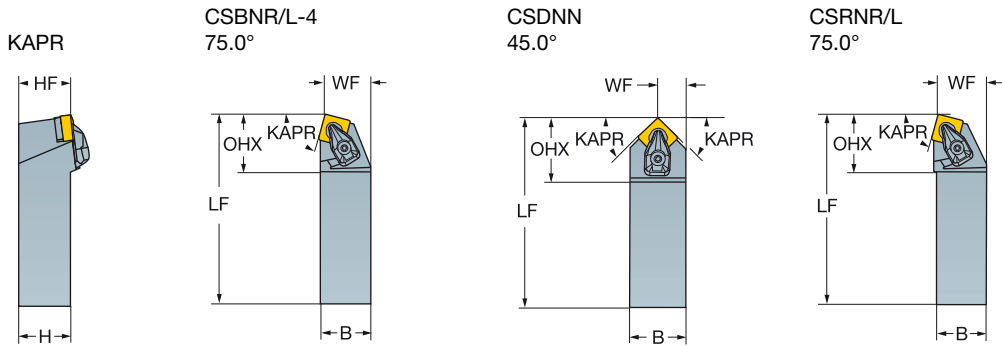

C

— SNG

D



Código para pedido	Dimensões, mm										MIID
	B	H	LF	WF	HF	NM	KG				
CSBNR/L 2525M 12-4	25.0	25.0	150.0	22.0	25.0	3.9	0.70	SNGN 12 07 08			
CSDNN 2525M 12-4	25.0	25.0	150.0	12.8	25.0	3.9	0.70	SNGN 12 07 08			
CSDNN 3225P 12-4	25.0	32.0	170.0	12.8	32.0	3.9	1.07	SNGN 12 07 08			
CSRNR/L 2525M 12-4	25.0	25.0	150.0	27.0	25.0	3.9	0.72	SNGN 12 07 08			
CSRNR/L 3225P 12-4	25.0	32.0	170.0	27.0	32.0	3.9	1.10	SNGN 12 07 08			
CSRNR/L 3225P 15-4	25.0	32.0	170.0	27.0	32.0	6.4	1.17	SNGN 15 07 12			
CSRNR/L 3232P 19-IC	32.0	32.0	170.0	35.0	32.0	7.5	1.42	SNGN 19 07 12			
CSRNR 2525M 09-ID	25.0	25.0	150.0	27.0	25.0	5.0	0.77	SNGN 09 03 08			

F

Quando usar pastilhas com 4,76 mm de espessura, calços opcionais devem ser solicitados.

N = neutra, R = versão direita, L = versão esquerda

G

Componentes			
Calço	Parafuso do calço	Jogo de fixação	
09	5322 425-02	5513 020-02	5412 034-021
12	5322 425-01	3212 100-206	5412 127-01
15	5322 425-05	5513 020-07	5412 034-031
19	5321 215-03	3212 100-257	5412 125-01

Para a lista completa de componentes, acesse www.sandvik.coromant.com

H



Ferramenta convencional T-Max® para torneamento

Desenho de fixação rígida para pastilhas de cerâmica

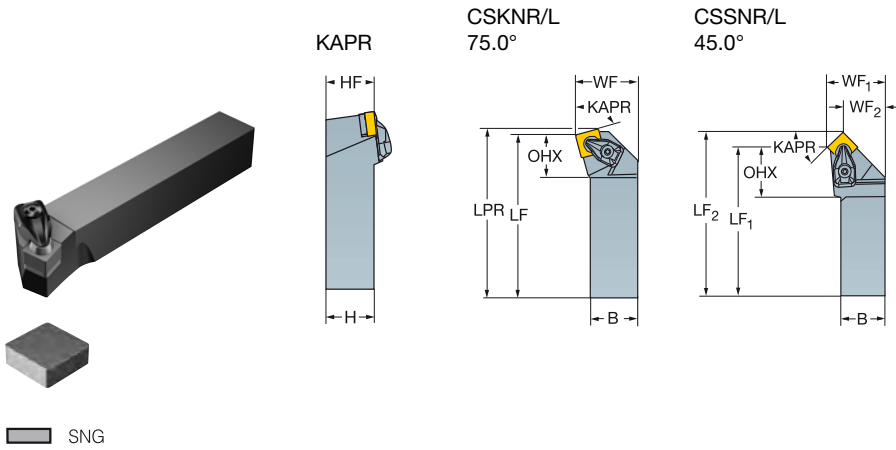

		Dimensões, mm												
		CZC _{MS}	RMPX	OHX	Código para pedido	B	H	LPR	LF	WF	HF	NM	KG	MIID
	12	25 x 25	10°	23.6	CSKNR/L 2525M 12-4	25.0	25.0	153.1	150.0	32.0	25.0	3.9	0.80	SNGN 12 07 08
	12	25 x 25	0°	27.3	CSSNR/L 2525M 12-4	25.0	25.0	158.3	150.0	32.0	25.0	3.9	0.86	SNGN 12 07 08
		32 x 25	0°	27.4	CSSNR/L 3225P 12-4	25.0	32.0	178.3	170.0	32.0	32.0	3.9	1.06	SNGN 12 07 08

Quando usar pastilhas com 4,76 mm de espessura, calços opcionais devem ser solicitados.

R = versão direita, L = versão esquerda

Componentes				
	CZC _{MS}	Calço	Parafuso do calço	Jogo de fixação
12	25 x 25-32 x 25	5322 425-02	5513 020-02	5412 034-021

Para a lista completa de componentes, acesse www.sandvik.coromant.com



A

Ferramenta convencional T-Max® para torneamento

Desenho de fixação rígida para pastilhas de cerâmica

B



KAPR

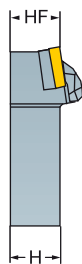

91.0°

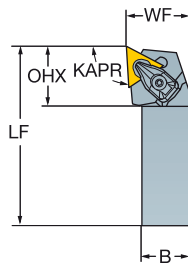

C

D



CZC _{MS}	OHX	Código para pedido	Dimensões, mm						NM	KG	MID
			B	H	LF	WF	HF				
16	25 x 25	20.0	CTGNR/L 2525M 16-ID	25.0	25.0	150.0	32.0	25.0	7.5	0.80	TNGN 16 07 08

Quando usar pastilhas com 4,76 mm de espessura, calços opcionais devem ser solicitados.

R = versão direita, L = versão esquerda

E

Componentes					
CZC _{MS}	Grampo	Placa de pressão	Calço	Parafuso do calço	
16	5412 125-01	5192 020-01	5322 329-01	5513 013-01	

Para a lista completa de componentes, acesse www.sandvik.coromant.com

F

G

H



A243



F2



E1



H36



H10

Cabeça T-Max® para torneamento

Desenho de fixação por grampo para pastilhas de cerâmica

CoroTurn® SL70 - Refrigeração interna de precisão

SL70-CRSCR/L

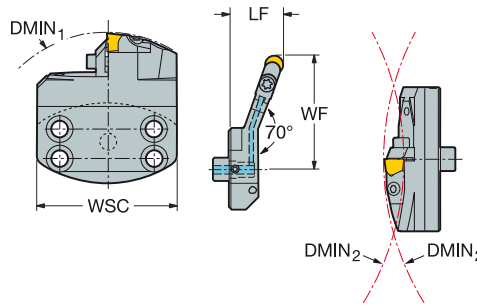

SL70-CRDRCR/L

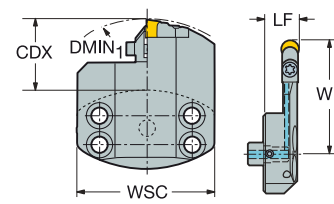

RCGX
RPGX

CZC _{MS}	CDX	DMIN ₁	DMIN ₂	DAXIN	APMX	RMPX	CNSC	Código para pedido	Dimensões, mm					MID	
									LF	WF	WSC	BAR	NM		KG
09	70	18.0	125.0	251.0			1	SL70-CRDRCR/L-18-09V	18.0	39.0	70.0	30	7.5	0.32	RCGX 09 07 00
	70	35.0	125.0	251.0			1	SL70-CRDRCR/L-35-09V	18.0	56.0	70.0	30	7.5	0.38	RCGX 09 07 00
	70	50.0	125.0	481.0			1	SL70-CRDRCR/L-50-09V	16.5	71.0	70.0	30	7.5	0.42	RCGX 09 07 00
12	70	35.0	180.0	244.6			1	SL70-CRDRCR/L-35-12V	18.0	56.0	70.0	30	7.5	0.40	RCGX 12 07 00
	70	50.0	180.0	244.6			1	SL70-CRDRCR/L-50-12V	18.0	71.0	70.0	30	7.5	0.48	RCGX 12 07 00
	70	75.0	180.0	294.6			1	SL70-CRDRCR/L-75-12V	18.0	96.0	70.0	30	7.5	0.60	RCGX 12 07 00
09	70	130.0	270.0		4.0	70°	1	SL70-CRSCR/L-35-09V	26.7	55.0	70.0	30		0.37	RCGX 09 07 00

R = versão direita, L = versão esquerda

Código para pedido	Componentes				
	Grampo	Parafuso de fixação	Assento	Parafuso do assento	Bucha-guia
SL70-CRDRCR/L-18-09V	5412 101-01	3212 035-452	5321 067-01	5512 031-08	5552 058-04
SL70-CRDRCR/L-35-09V	5412 101-01	3212 035-452	5321 067-01	5512 031-08	5552 058-04
SL70-CRDRCR/L-50-09V	5412 101-01	3212 035-452	5321 067-01	5512 031-08	5552 058-04
SL70-CRSCR/L-35-09V	5412 101-01	3212 035-452	5321 067-01	5512 031-08	5552 058-04
SL70-CRDRCR/L-35-12V	5412 101-02	3212 106-504	5321 067-02	3212 105-453	5552 058-04
SL70-CRDRCR/L-50-12V	5412 101-02	3212 106-504	5321 067-02	3212 105-453	5552 058-04
SL70-CRDRCR/L-75-12V	5412 101-02	3212 106-504	5321 067-02	3212 105-453	5552 058-04

Para a lista completa de componentes, acesse www.sandvik.coromant.com



A

TORNEAMENTO GERAL

Ferramentas externas

Ferramenta convencional T-Max® S para torneamento

Desenho de fixação por grampo para pastilhas de cerâmica

B

C

D

CZC _{MS}	RMPX	OHX	Código para pedido	Dimensões, mm								MIID	
				B	H	LPR	LF	WF	HF	NM	KG		
12	20 x 20	10°	30.1	CSBPL 2020K 12	20.0	20.0	125.0	17.0	20.0	5.0	0.40	SPUN 12 03 08	
	25 x 25	10°	30.1	CSBPR/L 2525M 12	25.0	25.0	150.0	22.0	25.0	5.0	0.73	SPUN 12 03 08	
12	20 x 20	40°	29.0	CSDPN 2020K 12	20.0	20.0	125.0	10.3	20.0	5.0	0.39	SPUN 12 03 08	
	25 x 25	40°	29.0	CSDPN 2525M 12	25.0	25.0	150.0	12.8	25.0	5.0	0.72	SPUN 12 03 08	
12	20 x 20	0°	18.7	CSDPR 2020K 12	20.0	20.0	125.0	116.7	22.0	20.0	5.0	0.35	SPUN 12 03 08
	25 x 25	0°	18.7	CSDPR/L 2525M 12	25.0	25.0	150.0	141.7	27.0	25.0	5.0	0.72	SPUN 12 03 08
12	25 x 25	10°	22.4	CSKPR 2525M 12	25.0	25.0	153.1	150.0	32.0	25.0	5.0	0.75	SPUN 12 03 08

F

Para componentes, visite www.sandvik.coromant.com

N = neutra, R = versão direita, L = versão esquerda

G

H

A 260

Ferramenta convencional T-Max® S para torneamento

Desenho de fixação por grampo para pastilhas de cerâmica



TPU

KAPR

CTDPR/L
45.0°

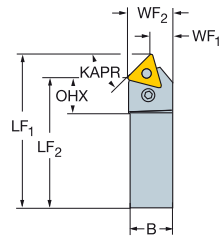

CTFPR/L
91.0°

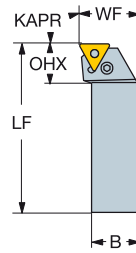

CTGPR/L
91.0°

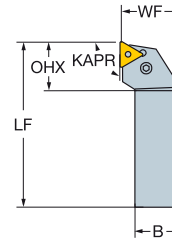

CTTPR/L
60.0°

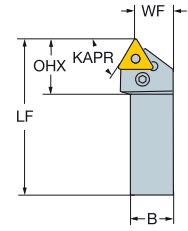

	CZC _{MS}	RMPX	OHX	Código para pedido	Dimensões, mm								MIID	
					B	H	LPR	LF	WF	HF	NM	KG		
	16	20 x 20	35°	30.2	CTDPR 2020K 16	20.0	20.0	125.0	125.0	11.8	20.0	5.0	0.40	TPUN 16 03 08
		25 x 25	35°	22.9	CTDPR/L 2525M 16	25.0	25.0	150.0	150.0	16.8	25.0	5.0	0.72	TPUN 16 03 08
	11	20 x 20	0°	18.5	CTFPR 2020K 11	20.0	20.0	125.0	25.0	20.0	3.5	0.40	TPUN 11 03 04	
	16	20 x 20	0°	20.0	CTFPR/L 2020K 16	20.0	20.0	125.0	25.0	20.0	5.0	0.42	TPUN 16 03 08	
		25 x 25	0°	20.0	CTFPR/L 2525M 16	25.0	25.0	150.0	32.0	25.0	5.0	0.75	TPUN 16 03 08	
	11	20 x 20	0°	21.0	CTGPR/L 2020K 11	20.0	20.0	125.0	25.0	20.0	3.5	0.40	TPUN 11 03 04	
		25 x 25	0°	22.0	CTGPL 2525M 11-ID	25.0	25.0	150.0	32.0	25.0	3.5	0.80	TPGN 11 03 04	
	16	20 x 20	0°	25.1	CTGPR/L 2020K 16	20.0	20.0	125.0	25.0	20.0	5.0	0.42	TPUN 16 03 08	
		25 x 25	0°	25.1	CTGPR/L 2525M 16	25.0	25.0	150.0	32.0	25.0	5.0	0.74	TPUN 16 03 08	
	32 x 25	0°	22.0	CTGPR 3225P 16-ID	25.0	32.0	170.0	32.0	32.0	5.0	1.13	TPGN 16 03 08		
	16	20 x 20	30°	30.2	CTTPR/L 2020K 16	20.0	20.0	125.0	17.0	20.0	5.0	0.40	TPUN 16 03 08	
		25 x 25	30°	39.6	CTTPR/L 2525M 16	25.0	25.0	150.0	22.0	25.0	5.0	0.73	TPUN 16 03 08	

Para componentes, visite www.sandvik.coromant.com

R = versão direita, L = versão esquerda



A

Unidade de corte T-Max® para torneamento

Desenho de fixação rígida para pastilhas de cerâmica

Coromant Capto® - Refrigeração interna

B

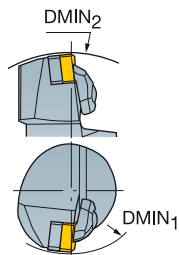
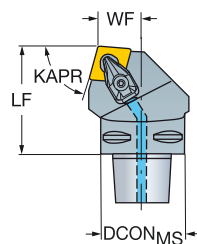
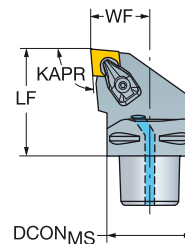

KAPR

Cx-CCRNR/L
75.0°Cx-CCLNR/L
95.0°

C



CNG

D

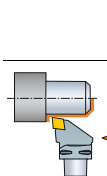

CZCMS	DMIN ₁	DMIN ₂	CNSC	Código para pedido	Dimensões, mm						MIID	
					DCON _{MS}	LF	WF	BAR	NM	KG		
12	C4	110.0	140.0	3	C4-CCLNR/L-27050-12-4	40.0	50.0	27.0	10	3.0	0.45	CNGN 12 07 08
	C5	110.0	165.0	3	C5-CCLNR/L-35060-12-4	50.0	60.0	35.0	10	3.0	0.80	CNGN 12 07 08
	C6	110.0	190.0	3	C6-CCLNR/L-45065-12-4	63.0	65.0	45.0	10	3.0	1.33	CNGN 12 07 08
16	C5	125.0	165.0	3	C5-CCLNR/L-35060-16-4	50.0	60.0	35.0	10	6.4	0.85	CNGN 16 07 12
	C6	125.0	190.0	3	C6-CCLNR/L-45065-16-4	63.0	65.0	45.0	10	6.4	1.36	CNGN 16 07 12
12	C4		140.0	3	C4-CCRNR/L-22050-12-4	40.0	50.0	22.0	10	3.0	0.44	CNGN 12 07 08
	C5		165.0	3	C5-CCRNR/L-27060-12-4	50.0	60.0	27.0	10	3.0	0.75	CNGN 12 07 08

E

Quando usar pastilhas com 4,76 mm de espessura, calços opcionais devem ser solicitados.

R = versão direita, L = versão esquerda

Componentes					
CZCMS	Calço	Parafuso do calço	Jogo de fixação	Olhal	
12	C4-C6	5322 234-02	5513 020-02	5412 034-021	5691 045-01
16	C5-C6	5322 234-04	5513 020-07	5412 034-031	5691 045-01

F

Para a lista completa de componentes, acesse www.sandvik.coromant.com

G

H



A243



F2



E1



G1



H36



H10



H5

Unidade de corte T-Max® para torneamento

Desenho de fixação rígida para pastilhas de cerâmica

Coromant Capto® - Refrigeração interna

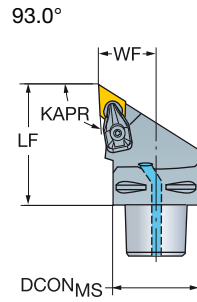
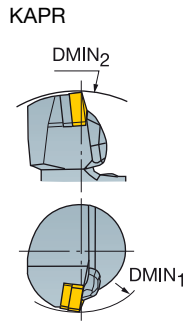
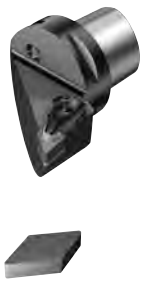

DNG

								Dimensões, mm							
		CZC _{MS}	DMIN ₁	DMIN ₂	RMPX	CNSC	Código para pedido	DCON _{MS}	LF	WF	BAR	NM	KG	MIID	
	15	C5	110.0	165.0	27°	3	C5-CDJNR/L-35060-15-4	50.0	60.0	35.0	10	3.9	0.73	DNGN 15 07 08	
		C6	110.0	190.0	27°	3	C6-CDJNR/L-45065-15-4	63.0	65.0	45.0	10	3.9	1.20	DNGN 15 07 08	

R = versão direita, L = versão esquerda

Quando usar pastilhas com 4,76 mm de espessura, calços opcionais devem ser solicitados.

Componentes			
Calço	Parafuso do calço	Jogo de fixação	Olhal
5322 266-03	5513 020-02	5412 034-021	5691 045-01

Para a lista completa de componentes, acesse www.sandvik.coromant.com



A

Unidade de corte T-Max® para torneamento

Desenho de fixação por grampo para pastilhas de cerâmica

Coromant Capto® - Refrigeração interna

B



Cx-CRDCN

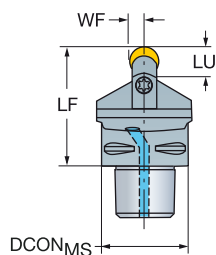

Cx-CRSCR/L

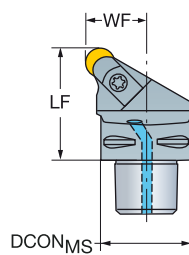

C



RCGX
RPGX

D

Dimensões, mm

Código para pedido	DCON _{MS}	LF	WF	BAR	NM	KG	MIID
09 C5 29.0 90° 3 C5-CRDCN-00060-09AV	50.0	60.0	4.8	10	7.5	0.58	RCGX 09 07 00
12 C5 38.0 90° 3 C5-CRDCN-00060-12AV	50.0	60.0	6.4	10	7.5	0.60	RCGX 12 07 00
09 C5 12° 3 C5-CRSCR/L-35060-09V	50.0	60.0	35.0	10	7.5	0.70	RCGX 09 07 00
12 C5 12° 3 C5-CRSCR/L-35060-12V	50.0	60.0	35.0	10	7.5	0.78	RCGX 12 07 00

E

N = neutra, R = versão direita, L = versão esquerda

Componentes						
CZC _{MS}	Grampo	Parafuso de fixação	Assento	Parafuso do assento	Olhal	
09 C5	5412 100-01	3212 035-452	5321 065-01	3212 106-352	5691 029-02	
12 C5	5412 100-02	3212 036-504	5321 065-02	3212 105-453	5691 029-02	

Para a lista completa de componentes, acesse www.sandvik.coromant.com

F

G

H



A243



F2



E1



G1



H36



H10



H5

Unidade de corte T-Max® para torneamento

Desenho de fixação por grampo para pastilhas de cerâmica

Coromant Capto® - Refrigeração interna

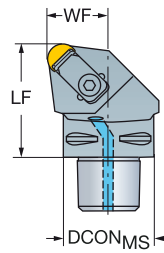

RNGA
 RNGN

	CZC _{MS}	RMPX	CNSC	Código para pedido	Dimensões, mm						MIID	
					DCON _{MS}	LF	WF	BAR	NM	KG		
	09	C3	7°	3	C3-CRSNR/L-22040-09ID	32.0	40.0	22.0	10	7.5	0.26	RNGN 09 03 00
		C4	0°	3	C4-CRSNR/L-27050-09ID	40.0	50.0	27.0	10	7.5	0.45	RNGN 09 03 00
		C5	0°	3	C5-CRSNR/L-35060-09ID	50.0	60.0	35.0	10	7.5	0.79	RNGN 09 03 00
		C6	0°	3	C6-CRSNR/L-45065-09ID	63.0	65.0	45.0	10	7.5	1.31	RNGN 09 03 00
	12	C4	7°	3	C4-CRSNR/L-27050-12ID	40.0	50.0	27.0	10	7.5	0.49	RNGN 12 07 00
		C5	0°	3	C5-CRSNR/L35060-1203ID	50.0	60.0	35.0	10	7.5	0.79	RNGN 12 03 00
		C5	7°	3	C5-CRSNR/L-35060-12ID	50.0	60.0	35.0	10	7.5	0.91	RNGN 12 07 00
		C6	0°	3	C6-CRSNR/L45065-1203ID	63.0	65.0	45.0	10	7.5	1.32	RNGN 12 03 00
		C6	7°	3	C6-CRSNR/L-45065-12ID	63.0	65.0	45.0	10	7.5	1.56	RNGN 12 07 00
		C4	0°	3	C4-CRSNR/L27050-1203ID	40.0	50.0	27.0	10	7.5	0.45	RNGN 12 03 00

R = versão direita, L = versão esquerda

Componentes						
	CZC _{MS}	Grampo	Placa de pressão	Calço	Parafuso do calço	Olhal
09	C3	5412 127-01		5321 215-01	3212 100-206	5691 029-01
09	C4-C6	5412 125-04	5192 020-03	5322 141-07	5512 031-16	5691 029-01
12	C4	5412 125-01	5192 020-01	5322 141-01	5513 013-02	5691 029-01
12	C5-C6	5412 125-01	5192 020-01	5322 141-01	5513 013-02	5691 029-02

Para a lista completa de componentes, acesse www.sandvik.coromant.com



A

Unidade de corte T-Max® para torneamento

Desenho de fixação rígida para pastilhas de cerâmica

Coromant Capto® - Refrigeração interna

B



KAPR

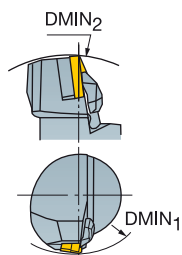

Cx-CSDNN
45.0°

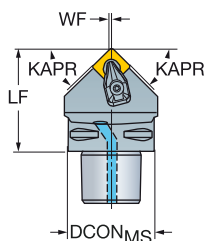

Cx-CSKNR/L
75.0°

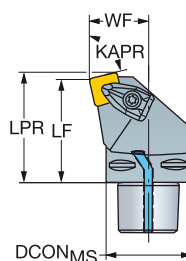

Cx-CSRNR/L
75.0°

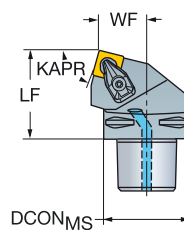

C

SNG

D

CZC _{MS}	CNC	DMIN ₁	DMIN ₂	RMPX	CNSC	Código para pedido	Dimensões, mm						MID	
							DCON _{MS}	LPR	LF	WF	BAR	NM		KG
12	C4			40°	3	C4-CSDNN-00050-12-4	40.0	50.0	0.3	10	3.9	0.34	SNGN 12 07 08	
	C5			40°	3	C5-CSDNN-00060-12-4	50.0	60.0	0.3	10	3.9	0.62	SNGN 12 07 08	
15	C5			40°	3	C5-CSDNN-00060-15-4	50.0	60.0	0.5	10	6.4	0.72	SNGN 15 07 12	
	C6			40°	3	C6-CSDNN-00065-15-4	63.0	65.0	0.5	10	6.4	1.22	SNGN 15 07 12	
12	C5	110.0		10°	3	C5-CSKNR/L-35060-12-4	50.0	63.1	60.0	35.0	10	3.9	0.86	SNGN 12 07 08
	C6	110.0		10°	3	C6-CSKNR/L-45065-12-4	63.0	68.1	65.0	45.0	10	3.9	1.38	SNGN 12 07 08
12	C4		140.0	10°	3	C4-CSRNR/L-22050-12-4	40.0	50.0	22.0	10	3.9	0.43	SNGN 12 07 08	
	C5		165.0	10°	3	C5-CSRNR/L-27060-12-4	50.0	60.0	27.0	10	3.9	0.73	SNGN 12 07 08	
	C6		190.0	10°	3	C6-CSRNR/L-35065-12-4	63.0	65.0	35.0	10	3.9	1.25	SNGN 12 07 08	

Quando usar pastilhas com 4,76 mm de espessura, calços opcionais devem ser solicitados.

N = neutra, R = versão direita, L = versão esquerda

F

Componentes					
CZC _{MS}	Calço	Parafuso do calço	Jogo de fixação	Olhal	
12	C4-C6	5322 425-02	5513 020-02	5412 034-021	5691 045-01
15	C5-C6	5322 425-05	5513 020-07	5412 034-031	5691 045-01

Para a lista completa de componentes, acesse www.sandvik.coromant.com

G

H



Unidade de corte T-Max® para torneamento

Desenho de fixação rígida para pastilhas de cerâmica

Coromant Capto® - Refrigeração interna



■ SNG

KAPR

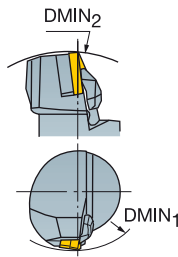

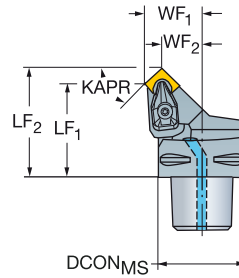

45.0°

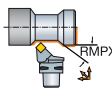
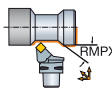

	CZC _{MS}	DMIN ₁	DMIN ₂	CN5C	Código para pedido	Dimensões, mm						MID		
						DCON _{MS}	LPR	LF	WF	BAR	NM		KG	
	12	C5	110.0	165.0	3	C5-CSSNR/L-35052-12-4	50.0	60.3	52.0	35.0	10	3.9	0.69	SNGN 12 07 08
		C6	110.0	190.0	3	C6-CSSNR/L-45056-12-4	63.0	64.3	56.0	45.0	10	3.9	1.12	SNGN 12 07 08
	15	C5	125.0	165.0	3	C5-CSSNR/L-35050-15-4	50.0	60.2	50.0	35.0	10	6.4	0.71	SNGN 15 07 12
		C6	125.0	190.0	3	C6-CSSNL-45054-15-4	63.0	64.2	54.0	45.0	10	6.4	1.14	SNGN 15 07 12

Quando usar pastilhas com 4,76 mm de espessura, calços opcionais devem ser solicitados.

R = versão direita, L = versão esquerda

Componentes						
	CZC _{MS}	Calço	Parafuso do calço	Jogo de fixação	Olhal	
	12	C5	5322 425-02	5513 020-02	5412 034-021	5691 029-01
	12	C6	5322 425-02	5513 020-02	5412 034-021	5691 045-01
	15	C5	5322 425-05	5513 020-07	5412 034-031	5691 029-01
	15	C6	5322 425-05	5513 020-07	5412 034-031	5691 045-01

Para a lista completa de componentes, acesse www.sandvik.coromant.com



A243



F2



E1



G1



H36



H10



H5

A

TORNEAMENTO GERAL

Ferramentas internas

Barra de mandrilar T-Max® para torneamento

Desenho de fixação por grampo para pastilhas de cerâmica

Cilíndrica com planos

B

KAPR

95.0°

C

CNGN

D

	Dimensões, mm													
	CZC _{MS}	DMIN ₁	OHX	OHN	Código para pedido	DCON _{MS}	H	BD	LF	WF	NM	KG	MIID	
	12	40	70.0	160.0	80.0	S40T-CCLNR 12-IC	40.0	37.0	40.0	300.0	27.0	3.0	2.90	CNGN 12 07 08
		50	70.0	200.0	100.0	S50U-CCLNR 12-IC	50.0	47.0	50.0	350.0	32.0	3.0	5.19	CNGN 12 07 08

R = versão direita

E

Componentes

Grampo (IC)	Quebra-cavaco	Calço	Parafuso do calço
5412 125-02	5192 022-04	5322 233-01	5513 013-02

Para a lista completa de componentes, acesse www.sandvik.coromant.com

F

G

H

A243

F2

G1

H36

H12

A 268

Barra de mandrilar T-Max® para torneamento

Desenho de fixação por grampo para pastilhas de cerâmica

Cilíndrica com planos

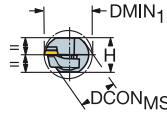
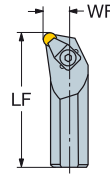
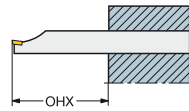

RPG

		Dimensões, mm					Dimensões, mm						MIID		
		CZC _{MS}	DMIN ₁	OHX	OHN	Código para pedido	DCON _{MS}	H	BD	LF	WF	NM	KG	RPGN 09 03 00	
	09	25	32.0	100.0	50.0	S25T-CRSPR/L 09-ID	25.0	23.0	25.0	300.0	17.0	7.5	1.12		

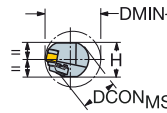
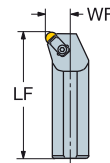
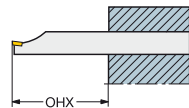

RNGA
RNGN

		Dimensões, mm					Dimensões, mm						MIID		
		CZC _{MS}	DMIN ₁	OHX	OHN	Código para pedido	DCON _{MS}	H	BD	LF	WF	NM	KG	RNGN 12 07 00	
	12	40	70.0	160.0	80.0	S40T-CRSNR/L 12-ID	40.0	37.0	40.0	300.0	27.0	7.5	2.88		

R = versão direita, L = versão esquerda

Componentes					
CZC _{MS}	Grampo	Placa de pressão	Calço	Parafuso do calço	
09	5412 126-03	5192 020-01	5322 141-01	5513 013-02	
12	5412 125-01				

Para a lista completa de componentes, acesse www.sandvik.coromant.com



CoroTurn® XS

Torneamento interno, usinagem de canais frontais e rosqueamento de peças pequenas

B

Aplicação

- Torneamento interno
- Cópia
- Mandrilamento reverso
- Perfilamento
- Canais
- Canais frontais
- Pré-corte
- Rosqueamento

C

Área de aplicação ISO:



D

Características e benefícios

- Otimizado para usinagem de alta qualidade de pequenas características
- Alta precisão e repetibilidade
- Sistema de fixação confiável e fácil de usar
- Ferramentas retificadas com precisão para alta repetibilidade
- Aumento da vida útil da ferramenta devido à minimização das microvibrações com adaptadores de hastes de metal duro cilíndricas
- A porca de fixação garante a troca rápida da ferramenta de corte com adaptadores de hastes de metal duro cilíndricas

E

www.sandvik.coromant.com/coroturnxs

Refrigeração interna

- Os adaptadores foram desenvolvidos com refrigeração interna de precisão
- Direção selecionável da refrigeração para melhor escoamento de cavacos e usinagem segura



Precisão de trava

Localização precisa na barra de mandrilar devido ao pino de localização.



F

Pastilhas

Torneamento	Mandrilament o reverso	Pré-corte	Canais	Canais frontais	Perfilamento	Rosqueamento
A272	A271	B116	B117	B120	B121	C60

Adaptadores

Coromant Capto®	Haste retangular	Haste cilíndrica com plano
F22	F33	F42

H

Ferramenta CoroTurn® XS inteiriça de metal duro para mandrilamento reverso

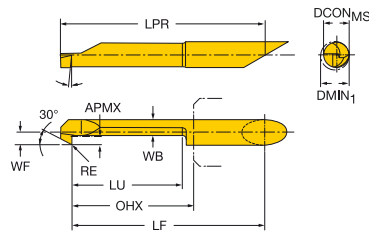

CZC _{MS}	RE	DMIN ₁	LU	APMX	RMPX	OHX	Código para pedido	P	M	N	S	O	Dimensões, mm					
								1025	1025	1025	1025	1025	DCON _{MS}	WB	LPR	LF	WF	
4	0.15	4.2	23.4	0.8	27°	26.0	CXS-04B090-15-4225R	*	*	*	*	*	*	4	2.6	42.3	40.3	2.0
5	0.15	5.2	28.5	1.0	27°	31.0	CXS-05B090-15-5230R	*	*	*	*	*	*	5	3.8	52.3	50.3	2.5
6	0.15	6.2	28.5	1.8	27°	31.0	CXS-06B090-15-6230R	*	*	*	*	*	*	6	4.0	52.3	50.3	3.0
7	0.15	7.2	27.5	2.5	27°	30.0	CXS-07B090-15-7230R	*	*	*	*	*	*	7	4.3	52.3	49.3	3.5

CZC_{MS} para corresponder com CZC_{WS} no adaptador.

R = versão direita



F2



B135



B149



H36



A

TORNEAMENTO GERAL

Ferramentas de corte

Ferramenta CoroTurn® XS inteiriça de metal duro para torneamento

POR

B

C

CZC _{MS}	RE	DMIN ₁	LU	APMX	RMPX	OHX	OHN	Código para pedido	Dimensões, mm												
									1025	1025	H10F	1025	H10F	1025	H10F	7015	1025	H10F	DCON _{MS}	WB	LF
4	0.00	0.3	1.2	0.1	17°	13.0		CXS-04T098-00-0301R	*	*		*	*		*		*	4	0.2	27.3	0.1
4	0.00	0.4	1.6	0.1	17°	13.0		CXS-04T098-00-0401L	*	*		*	*		*		*	4	0.3	27.3	0.2
4	0.00	0.4	1.6	0.1	17°	13.0		CXS-04T098-00-0401R	*	*		*	*		*		*	4	0.3	27.3	0.2
4	0.00	0.5	2.0	0.1	17°	13.0		CXS-04T098-00-0502L	*	*		*	*		*		*	4	0.4	27.3	0.2
4	0.00	0.5	2.0	0.1	17°	13.0		CXS-04T098-00-0502R	*	*		*	*		*		*	4	0.4	27.3	0.2
4	0.00	0.6	2.5	0.1	17°	13.0		CXS-04T098-00-0602R	*	*		*	*		*		*	4	0.5	27.3	0.3
4	0.00	0.7	3.5	0.1	17°	13.0		CXS-04T098-00-0703R	*	*		*	*		*		*	4	0.6	27.3	0.3
4	0.00	0.8	4.0	0.1	17°	13.0		CXS-04T098-00-0804R	*	*		*	*		*		*	4	0.6	27.3	0.4
4	0.00	0.9	5.0	0.1	17°	13.0		CXS-04T098-00-0905R	*	*		*	*		*		*	4	0.7	27.3	0.4
4	0.03	2.7	10.0	0.2	17°	13.0		CXS-04T098-03-2710R	*	*		*	*		*		*	4	2.1	27.3	1.2
4	0.03	3.2	10.0	0.2	17°	13.0		CXS-04T098-03-3210R	*	*		*	*		*		*	4	2.6	27.3	1.5
4	0.03	4.2	10.0	0.3	17°	13.0		CXS-04T098-03-4210R	*	*		*	*		*		*	4	3.5	27.3	2.0
4	0.05	1.0	4.0	0.1	17°	12.0		CXS-04T098-05-1004R	*	*		*	*		*		*	4	0.7	26.3	0.5
4	0.05	1.0	6.0	0.1	17°	12.0		CXS-04T098-05-1006R	*	*		*	*		*		*	4	0.7	26.3	0.5
4	0.05	1.7	6.0	0.2	17°	12.0		CXS-04T098-05-1706L	*	*		*	*		*		*	4	1.1	26.3	0.7
4	0.05	1.7	6.0	0.2	17°	12.0		CXS-04T098-05-1706R	*	*		*	*		*		*	4	1.1	26.3	0.7
4	0.05	1.7	9.0	0.2	17°	12.0		CXS-04T098-05-1709R	*	*		*	*		*		*	4	1.1	26.3	0.7
4	0.05	2.2	6.0	0.2	17°	12.0		CXS-04T098-05-2206R	*	*		*	*		*		*	4	1.6	26.3	1.0
4	0.05	2.2	9.0	0.2	17°	12.0		CXS-04T098-05-2209L	*	*		*	*		*		*	4	1.6	26.3	1.0
4	0.05	2.2	9.0	0.2	17°	12.0		CXS-04T098-05-2209R	*	*		*	*		*		*	4	1.6	26.3	1.0
4	0.05	2.7	10.0	0.2	17°	13.0		CXS-04T098-05-2710L	*	*		*	*		*		*	4	2.1	27.3	1.2
4	0.05	2.7	10.0	0.2	17°	13.0		CXS-04T098-05-2710R	*	*		*	*		*		*	4	2.1	27.3	1.2
4	0.05	2.7	15.0	0.2	17°	18.0		CXS-04T098-05-2715L	*	*		*	*		*		*	4	2.1	32.3	1.2
4	0.05	2.7	15.0	0.2	17°	18.0		CXS-04T098-05-2715R	*	*		*	*		*		*	4	2.1	32.3	1.2
4	0.05	3.2	15.0	0.2	17°	18.0		CXS-04T098-05-3215L	*	*		*	*		*		*	4	2.6	32.3	1.5
4	0.05	3.2	15.0	0.2	17°	18.0		CXS-04T098-05-3215R	*	*		*	*		*		*	4	2.6	32.3	1.5
4	0.05	3.2	20.0	0.2	17°	23.0		CXS-04T098-05-3220L	*	*		*	*		*		*	4	2.6	37.3	1.5
4	0.05	3.2	20.0	0.2	17°	23.0		CXS-04T098-05-3220R	*	*		*	*		*		*	4	2.6	37.3	1.5
4	0.05	4.2	15.0	0.3	17°	18.0		CXS-04T098-05-4215L	*	*		*	*		*		*	4	3.5	32.3	2.0
4	0.05	4.2	15.0	0.3	17°	18.0		CXS-04T098-05-4215R	*	*		*	*		*		*	4	3.5	32.3	2.0
4	0.05	4.2	20.0	0.3	17°	23.0		CXS-04T098-05-4220R	*	*		*	*		*		*	4	3.5	37.3	2.0
4	0.05	4.2	25.0	0.3	17°	28.0		CXS-04T098-05-4225L	*	*		*	*		*		*	4	3.5	42.3	2.0
4	0.05	4.2	25.0	0.3	17°	28.0		CXS-04T098-05-4225R	*	*		*	*		*		*	4	3.5	42.3	2.0
4	0.08	4.2	30.0	0.5	2°	38.0	38.0	CXS-04T098A08-4230R	*	*		*	*		*		*	4	3.6	52.3	2.0
4	0.10	1.0	4.0	0.1	17°	13.0		CXS-04T098-10-1004L	*	*		*	*		*		*	4	0.7	27.3	0.5
4	0.10	1.0	4.0	0.1	17°	13.0		CXS-04T098-10-1004R	*	*		*	*		*		*	4	0.7	27.3	0.5
4	0.10	1.0	6.0	0.1	17°	13.0		CXS-04T098-10-1006R	*	*		*	*		*		*	4	0.7	27.3	0.5
4	0.10	1.7	6.0	0.2	17°	13.0		CXS-04T098-10-1706L	*	*		*	*		*		*	4	1.1	27.3	0.7
4	0.10	1.7	6.0	0.2	17°	13.0		CXS-04T098-10-1706R	*	*		*	*		*		*	4	1.1	27.3	0.7
4	0.10	1.7	9.0	0.2	17°	13.0		CXS-04T098-10-1709L	*	*		*	*		*		*	4	1.1	27.3	0.7
4	0.10	1.7	9.0	0.2	17°	13.0		CXS-04T098-10-1709R	*	*		*	*		*		*	4	1.1	27.3	0.7
4	0.10	2.2	6.0	0.2	17°	13.0		CXS-04T098-10-2206L	*	*		*	*		*		*	4	1.6	27.3	1.0
4	0.10	2.2	6.0	0.2	17°	13.0		CXS-04T098-10-2206R	*	*		*	*		*		*	4	1.6	27.3	1.0
4	0.10	2.2	9.0	0.2	17°	13.0		CXS-04T098-10-2209L	*	*		*	*		*		*	4	1.6	27.3	1.0
4	0.10	2.2	9.0	0.2	17°	13.0		CXS-04T098-10-2209R	*	*		*	*		*		*	4	1.6	27.3	1.0
4	0.10	2.2	13.0	0.2	17°	18.0		CXS-04T098-10-2213L	*	*		*	*		*		*	4	1.6	32.3	1.0
4	0.10	2.2	13.0	0.2	17°	18.0		CXS-04T098-10-2213R	*	*		*	*		*		*	4	1.6	32.3	1.0
4	0.15	3.2	12.0	0.2	17°	15.0		CXS-04T090-15-3212L	*	*		*	*		*		*	4	2.6	29.3	1.5
4	0.15	3.2	12.0	0.2	17°	15.0		CXS-04T090-15-3212R	*	*		*	*		*		*	4	2.6	29.3	1.5
4	0.15	4.2	15.0	0.3	17°	18.0		CXS-04T090-15-4215L	*	*		*	*		*		*	4	3.5	32.3	2.0
4	0.15	4.2	15.0	0.3	17°	18.0		CXS-04T090-15-4215R	*	*		*	*		*		*	4	3.5	32.3	2.0
4	0.15	2.7	10.0	0.2	17°	13.0		CXS-04T098-15-2710L	*	*		*	*		*		*	4	2.1	27.3	1.2
4	0.15	2.7	10.0	0.2	17°	13.0		CXS-04T098-15-2710R	*	*		*	*		*		*	4	2.1	27.3	1.2
4	0.15	2.7	15.0	0.2	17°	18.0		CXS-04T098-15-2715L	*	*		*	*		*		*	4	2.1	32.3	1.2
4	0.15	2.7	15.0	0.2	17°	18.0		CXS-04T098-15-2715R	*	*		*	*		*		*	4	2.1	32.3	1.2
4	0.15	3.2	10.0	0.2	17°	13.0		CXS-04T098-15-3210L	*	*		*	*		*		*	4	2.6	27.3	1.5
4	0.15	3.2	10.0	0.2	17°	13.0		CXS-04T098-15-3210R	*	*		*	*		*		*	4	2.6	27.3	1.5
4	0.15	3.2	15.0	0.2	17°	18.0		CXS-04T098-15-3215L	*	*		*	*		*		*	4	2.6	32.3	1.5
4	0.15	3.2	15.0	0.2	17°	18.0		CXS-04T098-15-3215R	*	*		*	*		*		*	4	2.6	32.3	1.5
4	0.15	3.2	20.0	0.2	17°	23.0		CXS-04T098-15-3220L	*	*		*	*		*		*	4	2.6	37.3	1.5

H

CZC_{MS} para corresponder com CZC_{WS} no adaptador.

R = versão direita, L = versão esquerda

F2

B135

B149

H36

A 272

Ferramenta CoroTurn® XS inteiriça de metal duro para torneamento

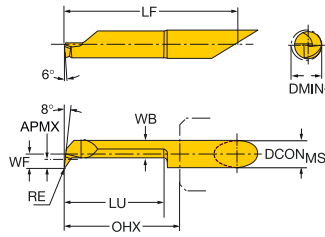

CZC _{MS}	RE	DMIN ₁	LU	APMX	RMPX	OHX	OHN	Código para pedido	Dimensões, mm										
									P	M	N	S	H	O	DCON _{MS}	WB	LF	WF	
4	0.15	3.2	20.0	0.2	17°	23.0		CXS-04T098-15-3220R	★	★						4	2.6	37.3	1.5
4	0.15	3.7	15.0	0.2	17°	18.0		CXS-04T098-15-3715R						★		4	3.1	32.3	1.7
4	0.15	4.2	10.0	0.3	17°	13.0		CXS-04T098-15-4210L	★	★	★	★		★		4	3.5	27.3	2.0
4	0.15	4.2	10.0	0.3	17°	13.0		CXS-04T098-15-4210R	★	★	★	★		★		4	3.5	27.3	2.0
4	0.15	4.2	15.0	0.3	17°	18.0		CXS-04T098-15-4215L	★	★	★	★		★		4	3.5	32.3	2.0
4	0.15	4.2	15.0	0.3	17°	18.0		CXS-04T098-15-4215R	★	★	★	★		★		4	3.5	32.3	2.0
4	0.15	4.2	20.0	0.3	17°	23.0		CXS-04T098-15-4220L	★	★	★	★		★		4	3.5	37.3	2.0
4	0.15	4.2	20.0	0.3	17°	23.0		CXS-04T098-15-4220R	★	★	★	★		★		4	3.5	37.3	2.0
4	0.15	4.2	25.0	0.3	17°	28.0		CXS-04T098-15-4225L	★	★	★	★		★		4	3.5	42.3	2.0
4	0.15	4.2	25.0	0.3	17°	28.0		CXS-04T098-15-4225R	★	★	★	★		★		4	3.5	42.3	2.0
4	0.15	4.2	10.2	0.5	0°	13.0		CXS-04T098A15-4210R	★	★	★	★		★		4	3.8	27.3	2.0
4	0.15	4.2	20.3	0.5	0°	23.0		CXS-04T098A15-4220L	★	★	★	★		★		4	3.8	37.3	2.0
4	0.15	4.2	20.3	0.5	0°	23.0		CXS-04T098A15-4220R	★	★	★	★		★		4	3.8	37.3	2.0
4	0.15	4.2	25.3	0.5	0°	28.0		CXS-04T098A15-4225R	★	★	★	★		★		4	3.8	42.3	2.0
4	0.15	4.2	15.3	0.3	0°	18.0		CXS-04T098A20-4215L	★	★	★	★		★		4	3.1	32.3	2.0
4	0.15	4.2	15.3	0.3	0°	18.0		CXS-04T098A20-4215R	★	★	★	★		★		4	3.1	32.3	2.0
4	0.15	4.2	20.0	0.8	44°	23.0		CXS-04TE98-15-4220L	★	★	★	★		★		4	3.0	37.3	2.0
4	0.15	4.2	20.0	0.8	44°	23.0		CXS-04TE98-15-4220R	★	★	★	★		★		4	3.0	37.3	2.0
5	0.05	5.2	20.0	0.5	17°	23.0		CXS-05T098-05-5220L	★	★	★	★		★		5	4.3	42.3	2.5
5	0.05	5.2	20.0	0.5	17°	23.0		CXS-05T098-05-5220R	★	★	★	★		★		5	4.3	42.3	2.5
5	0.05	5.2	30.0	0.5	17°	33.0		CXS-05T098-05-5230L	★	★	★	★		★		5	4.3	52.3	2.5
5	0.05	5.2	30.0	0.5	17°	33.0		CXS-05T098-05-5230R	★	★	★	★		★		5	4.3	52.3	2.5
5	0.08	5.2	40.0	0.5	2°	48.0	48.0	CXS-05T098A08-5240R	★	★	★	★		★		5	4.6	67.3	2.5
5	0.15	5.2	25.0	1.0	44°	28.0		CXS-05TE98-15-5225L	★	★	★	★		★		5	3.8	47.3	2.5
5	0.15	5.2	25.0	1.0	44°	28.0		CXS-05TE98-15-5225R	★	★	★	★		★		5	3.8	47.3	2.5
5	0.20	5.2	10.0	0.5	17°	13.0		CXS-05T090-20-5210L	★	★	★	★		★		5	4.2	32.3	2.5
5	0.20	5.2	10.0	0.5	17°	13.0		CXS-05T090-20-5210R	★	★	★	★		★		5	4.2	32.3	2.5
5	0.20	5.2	15.0	0.5	17°	18.0		CXS-05T090-20-5215L	★	★	★	★		★		5	4.2	37.3	2.5
5	0.20	5.2	15.0	0.5	17°	18.0		CXS-05T090-20-5215R	★	★	★	★		★		5	4.2	37.3	2.5
5	0.20	5.2	20.0	0.5	17°	23.0		CXS-05T090-20-5220L	★	★	★	★		★		5	4.2	42.3	2.5
5	0.20	5.2	20.0	0.5	17°	23.0		CXS-05T090-20-5220R	★	★	★	★		★		5	4.2	42.3	2.5
5	0.20	5.2	10.0	0.5	17°	13.0		CXS-05T098-20-5210L	★	★	★	★		★		5	4.3	32.3	2.5
5	0.20	5.2	10.0	0.5	17°	13.0		CXS-05T098-20-5210R	★	★	★	★		★		5	4.3	32.3	2.5
5	0.20	5.2	20.0	0.5	17°	23.0		CXS-05T098-20-5220L	★	★	★	★		★		5	4.3	42.3	2.5
5	0.20	5.2	20.0	0.5	17°	23.0		CXS-05T098-20-5220R	★	★	★	★		★		5	4.3	42.3	2.5
5	0.20	5.2	25.0	0.5	17°	28.0		CXS-05T098-20-5225L	★	★	★	★		★		5	4.3	47.3	2.5
5	0.20	5.2	25.0	0.5	17°	28.0		CXS-05T098-20-5225R	★	★	★	★		★		5	4.3	47.3	2.5
5	0.20	5.2	30.0	0.5	17°	33.0		CXS-05T098-20-5230L	★	★	★	★		★		5	4.3	52.3	2.5
5	0.20	5.2	30.0	0.5	17°	33.0		CXS-05T098-20-5230R	★	★	★	★		★		5	4.3	52.3	2.5
5	0.20	5.2	35.0	0.5	17°	38.0		CXS-05T098-20-5235R	★	★	★	★		★		5	4.3	57.3	2.5
5	0.20	5.2	40.0	0.5	17°	43.0		CXS-05T098-20-5240L	★	★	★	★		★		5	4.3	62.3	2.5
5	0.20	5.2	40.0	0.5	17°	43.0		CXS-05T098-20-5240R	★	★	★	★		★		5	4.3	62.3	2.5
5	0.20	5.2	10.2	0.6	0°	13.0		CXS-05T098A20-5210R	★	★	★	★		★		5	4.8	32.3	2.5
5	0.20	5.2	15.0	0.5	0°	18.0		CXS-05T098A20-5215L	★	★	★	★		★		5	4.3	37.3	2.5
5	0.20	5.2	15.0	0.5	0°	18.0		CXS-05T098A20-5215R	★	★	★	★		★		5	4.3	37.3	2.5
5	0.20	5.2	20.3	0.6	0°	23.0		CXS-05T098A20-5220R	★	★	★	★		★		5	4.8	42.3	2.5
5	0.20	5.2	25.4	0.5	0°	28.0		CXS-05T098A20-5225L	★	★	★	★		★		5	4.8	47.3	2.5
5	0.20	5.2	25.4	0.5	0°	28.0		CXS-05T098A20-5225R	★	★	★	★		★		5	4.8	47.3	2.5
5	0.20	5.2	30.5	0.6	0°	33.0		CXS-05T098A20-5230R	★	★	★	★		★		5	4.8	52.3	2.5
6	0.05	6.2	20.0	0.5	17°	23.0		CXS-06T098-05-6220L	★	★	★	★		★		6	5.3	42.3	3.0
6	0.05	6.2	20.0	0.5	17°	23.0		CXS-06T098-05-6220R	★	★	★	★		★		6	5.3	42.3	3.0
6	0.08	6.2	45.0	0.5	2°	53.0	53.0	CXS-06T098A08-6245R	★	★	★	★		★		6	5.5	72.3	3.0
6	0.15	6.2	30.0	1.8	44°	33.0		CXS-06TE98-15-6230L	★	★	★	★		★		6	4.0	52.3	3.0
6	0.15	6.2	30.0	1.8	44°	33.0		CXS-06TE98-15-6230R	★	★	★	★		★		6	4.0	52.3	3.0
6	0.20	6.2	15.0	0.5	17°	18.0		CXS-06T098-20-6215L	★	★	★	★		★		6	5.3	37.3	3.0
6	0.20	6.2	15.0	0.5	17°	18.0		CXS-06T098-20-6215R	★	★	★	★		★		6	5.3	37.3	3.0
6	0.20	6.2	20.0	0.5	17°	23.0		CXS-06T098-20-6220L	★	★	★	★		★		6	5.3	42.3	3.0
6	0.20	6.2	20.0	0.5	17°	23.0		CXS-06T098-20-6220R	★	★	★	★		★		6	5.3	42.3	3.0
6	0.20	6.2	25.0	0.5	17°	28.0		CXS-06T098-20-6225L	★	★	★	★		★		6	5.3	47.3	3.0
6	0.20	6.2	25.0	0.5	17°	28.0		CXS-06T098-20-6225R	★	★	★	★		★		6	5.3	47.3	3.0

CZC_{MS} para corresponder com CZC_{WS} no adaptador.

R = versão direita, L = versão esquerda



F2



B135



B149



H36



Ferramenta CoroTurn® XS inteiriça de metal duro para torneamento

FOR

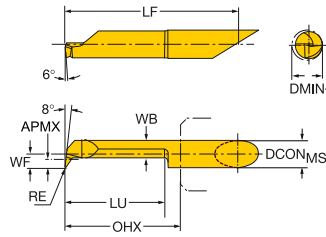

C

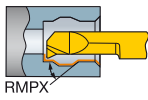

CZC _{MS}	RE	DMIN ₁	LU	APMX	RMPX	OHX	OHN	Código para pedido	Dimensões, mm												
									1025	1025	H10F	1025	H10F	1025	H10F	7015	1025	H10F	DCON _{MS}	WB	LF
6	0.20	6.2	30.0	0.5	17°	33.0		CXS-06T098-20-6230L	*	*	*	*	*	*	*	*	*	6	5.3	52.3	3.0
6	0.20	6.2	30.0	0.5	17°	33.0		CXS-06T098-20-6230R	*	*	*	*	*	*	*	*	*	6	5.3	52.3	3.0
6	0.20	6.2	35.0	0.5	17°	38.0		CXS-06T098-20-6235L	*	*	*	*	*	*	*	*	*	6	5.3	57.3	3.0
6	0.20	6.2	35.0	0.5	17°	38.0		CXS-06T098-20-6235R	*	*	*	*	*	*	*	*	*	6	5.3	57.3	3.0
6	0.20	6.2	40.0	0.5	17°	43.0		CXS-06T098-20-6240L	*	*	*	*	*	*	*	*	*	6	5.3	62.3	3.0
6	0.20	6.2	40.0	0.5	17°	43.0		CXS-06T098-20-6240R	*	*	*	*	*	*	*	*	*	6	5.3	62.3	3.0
6	0.20	6.2	15.2	0.8	0°	18.0		CXS-06T098A20-6215L	*	*	*	*	*	*	*	*	*	6	5.7	37.3	3.0
6	0.20	6.2	15.2	0.8	0°	18.0		CXS-06T098A20-6215R	*	*	*	*	*	*	*	*	*	6	5.7	37.3	3.0
6	0.20	6.2	20.3	0.8	0°	23.0		CXS-06T098A20-6220L	*	*	*	*	*	*	*	*	*	6	5.7	42.3	3.0
6	0.20	6.2	20.3	0.8	0°	23.0		CXS-06T098A20-6220R	*	*	*	*	*	*	*	*	*	6	5.7	42.3	3.0
6	0.20	6.2	25.4	0.8	0°	28.0		CXS-06T098A20-6225L	*	*	*	*	*	*	*	*	*	6	5.7	47.3	3.0
6	0.20	6.2	25.4	0.8	0°	28.0		CXS-06T098A20-6225R	*	*	*	*	*	*	*	*	*	6	5.7	47.3	3.0
6	0.20	6.2	30.5	0.5	0°	33.0		CXS-06T098A20-6230L	*	*	*	*	*	*	*	*	*	6	5.7	52.3	3.0
6	0.20	6.2	30.5	0.5	0°	33.0		CXS-06T098A20-6230R	*	*	*	*	*	*	*	*	*	6	5.7	52.3	3.0
6	0.20	6.2	40.0	0.5	0°	43.0		CXS-06T098A20-6240R	*	*	*	*	*	*	*	*	*	6	5.3	62.3	3.0
7	0.08	7.2	55.0	0.5	2°	63.0		CXS-07T098A08-7255R	*	*	*	*	*	*	*	*	*	7	6.5	82.3	3.5
7	0.20	7.2	25.0	0.5	17°	28.0		CXS-07T098-20-7225L	*	*	*	*	*	*	*	*	*	7	6.3	47.3	3.5
7	0.20	7.2	25.0	0.5	17°	28.0		CXS-07T098-20-7225R	*	*	*	*	*	*	*	*	*	7	6.3	47.3	3.5
7	0.20	7.2	30.0	0.5	17°	33.0		CXS-07T098-20-7230L	*	*	*	*	*	*	*	*	*	7	6.3	52.3	3.5
7	0.20	7.2	30.0	0.5	17°	33.0		CXS-07T098-20-7230R	*	*	*	*	*	*	*	*	*	7	6.3	52.3	3.5
7	0.20	7.2	40.0	0.5	17°	43.0		CXS-07T098-20-7240L	*	*	*	*	*	*	*	*	*	7	6.3	62.3	3.5
7	0.20	7.2	40.0	0.5	17°	43.0		CXS-07T098-20-7240R	*	*	*	*	*	*	*	*	*	7	6.3	62.3	3.5
7	0.20	7.2	45.0	0.5	17°	48.0		CXS-07T098-20-7245L	*	*	*	*	*	*	*	*	*	7	6.3	67.3	3.5
7	0.20	7.2	45.0	0.5	17°	48.0		CXS-07T098-20-7245R	*	*	*	*	*	*	*	*	*	7	6.3	67.3	3.5
7	0.20	7.2	50.0	0.5	17°	53.0		CXS-07T098-20-7250L	*	*	*	*	*	*	*	*	*	7	6.3	72.3	3.5
7	0.20	7.2	50.0	0.5	17°	53.0		CXS-07T098-20-7250R	*	*	*	*	*	*	*	*	*	7	6.3	72.3	3.5
7	0.20	7.2	25.4	0.9	0°	28.0		CXS-07T098A20-7225R	*	*	*	*	*	*	*	*	*	7	6.7	47.3	3.5
7	0.20	7.2	30.5	0.9	0°	33.0		CXS-07T098A20-7230R	*	*	*	*	*	*	*	*	*	7	6.7	52.3	3.5
7	0.20	7.2	40.6	0.5	0°	43.0		CXS-07T098A20-7240L	*	*	*	*	*	*	*	*	*	7	6.7	62.3	3.5
7	0.20	7.2	40.6	0.5	0°	43.0		CXS-07T098A20-7240R	*	*	*	*	*	*	*	*	*	7	6.7	62.3	3.5
7	0.20	7.2	40.0	2.5	44°	43.0		CXS-07TE98-20-7240L	*	*	*	*	*	*	*	*	*	7	6.3	62.3	4.2
7	0.20	7.2	40.0	2.5	44°	43.0		CXS-07TE98-20-7240R	*	*	*	*	*	*	*	*	*	7	6.3	62.3	4.2

CZC_{MS} para corresponder com CZC_{WS} no adaptador.

R = versão direita, L = versão esquerda

F

G

H



Ferramenta CoroTurn® XS inteiriça de metal duro para torneamento

Torneamento/perfilamento

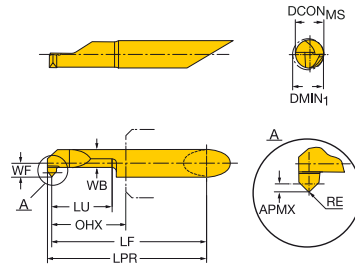

B

C

CZC _{MS}	RE	DMIN ₁	LU	APMX	RMPX	OHX	Código para pedido	Dimensões, mm										
								P	M	N	S	O	DCON _{MS}	WB	LPR	LF	WF	
								1025	1025	1025	1025							
								1025	1025	1025	1025							
								1025	1025	1025	1025							
								1025	1025	1025	1025							
								1025	1025	1025	1025							
								1025	1025	1025	1025							
								1025	1025	1025	1025							
								1025	1025	1025	1025							
								1025	1025	1025	1025							
								1025	1025	1025	1025							
								1025	1025	1025	1025							
								1025	1025	1025	1025							

D

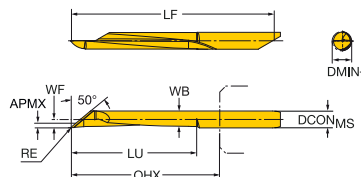

E

F

CZC _{MS}	RE	DMIN ₁	LU	APMX	RMPX	OHX	Código para pedido	Dimensões, mm										
								P	M	N	S	O	DCON _{MS}	WB	LPR	LF	WF	
								1025	1025	1025	1025							
								1025	1025	1025	1025							
								1025	1025	1025	1025							
								1025	1025	1025	1025							
								1025	1025	1025	1025							
								1025	1025	1025	1025							
								1025	1025	1025	1025							
								1025	1025	1025	1025							
								1025	1025	1025	1025							

G

CZC_{MS} para corresponder com CZC_{WS} no adaptador.

R = versão direita, L = versão esquerda



F2



B135



B149



H36



H

CoroCut® XS

Para usinagem externa de peças pequenas e delgadas

B

Aplicação

- Corte
- Rosqueamento externo
- Canais externos
- Torneamento

C

Área de aplicação ISO:



Características e benefícios

- Alta precisão
- Tolerâncias estreitas
- Boa acessibilidade ao trocar as pastilhas
- Ampla variedade de larguras de pastilhas
- Arestas de corte vivas
- Todas as pastilhas se adaptam ao mesmo porta-ferramentas
- Suportes e pastilhas retificadas de alta qualidade
- Pastilhas de perfil completo para roscas de alta qualidade em uma operação
- Desenvolvido para manter o porta-ferramenta intacto caso a pastilha quebre.
- Disponível com refrigeração de alta precisão



D

E

www.sandvik.coromant.com/corocutxs

Suportes

Suportes dedicados para cortes próximos ao subspindle estão disponíveis com haste quadrada de alta precisão.

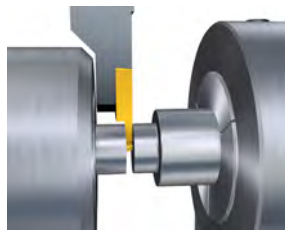

F

Pastilhas

Torneamento	Torneamento reverso	Corte	Canais	Perfilamento	Rosqueamento
A277	A277	B97	B117	B121	C56

Ferramentas

Ferramenta convencional QS™	Cabeças de corte CoroTurn® SL
B99	B100

H

Pastilha CoroCut® XS para torneamento

Torneamento, torneamento frontal

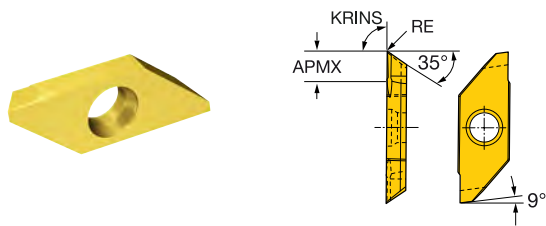

Acabamento	SSC	S	RE	APMX	CÓDIGO ISO	P		M		K		N		S	
						1025	H13A	1025	H13A	1025	H13A	1025	H13A	1025	H13A
	3	3.18	0.03	4.0	MAFR/L 3 003	★	☆	★	☆	★	☆	★	☆	★	☆
		3.18	0.05	4.0	MAFR/L 3 005	★	☆	★	☆	★	☆	★	☆	★	☆
		3.18	0.10	4.0	MAFR/L 3 010	★	☆	★	☆	★	☆	★	☆	★	☆
		3.18	0.20	4.0	MAFR/L 3 020	★	☆	★	☆	★	☆	★	☆	★	☆

B

C

Torneamento, torneamento reverso

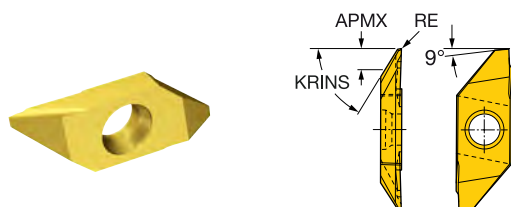

Acabamento	SSC	S	RE	APMX	CÓDIGO ISO	P		M		K		N		S	
						1025	H13A	1025	H13A	1025	H13A	1025	H13A	1025	H13A
	3	3.18	0.03	4.0	MABR 3 003	★	☆	★	☆	★	☆	★	☆	★	☆
		3.18	0.03	4.0	MABL 3 003	★	☆	★	☆	★	☆	★	☆	★	☆
		3.18	0.05	4.0	MABR 3 005	★	☆	★	☆	★	☆	★	☆	★	☆
		3.18	0.05	4.0	MABL 3 005	★	☆	★	☆	★	☆	★	☆	★	☆
		3.18	0.10	4.0	MABR 3 010	★	☆	★	☆	★	☆	★	☆	★	☆
		3.18	0.10	4.0	MABL 3 010	★	☆	★	☆	★	☆	★	☆	★	☆
		3.18	0.20	4.0	MABR 3 020	★	☆	★	☆	★	☆	★	☆	★	☆
		3.18	0.20	4.0	MABL 3 020	★	☆	★	☆	★	☆	★	☆	★	☆

D

E

SSC = Para corresponder ao SSC na ferramenta.

R = versão direita, L = versão esquerda

F

G

H



B99



B136



B149



H36

Recomendações de velocidade de corte

As recomendações são válidas para uso com refrigeração.

ISO P	No. CMC	Aços	Força de corte específica k_{c1}	Dureza Brinell	<<<< RESISTÊNCIA AO DESGASTE			
					CT5015	GC1525	GC4305	GC4315
					h_{ex} , mm \approx avanço f_n , mm/r			
					0.05-0.1-0.2	0.05-0.1-0.2	0.1-0.4-0.8	0.1-0.4-0.8
N° MC	No. CMC	Material	N/mm ²	HB	Velocidade de corte (V_c) m/min			
P1.1.Z.AN	01.1	Aços sem liga C = 0.1-0.25%	1500	125	650-540-440	560-465-380	620-450-330	570-405-300
P1.2.Z.AN	01.2	C = 0.25-0.55%	1600	150	380-245-180	495-415-335	560-405-295	510-365-265
P1.3.Z.AN	01.3	C = 0.55-0.80%	1700	170	510-425-340	430-365-295	530-385-275	460-330-240
P2.1.Z.AN	02.1	Aços baixa-liga (elementos de liga $\leq 5\%$) Não endurecidos	1700	180	480-400-320	375-320-255	610-410-285	560-370-260
P2.1.Z.AN	02.12	Aços para rolamento de esferas	1800	210	-	-	530-350-250	460-305-215
P2.5.Z.HT	02.2	Endurecidos e temperados	1850	275	285-235-190	200-165-135	330-230-175	300-210-155
P2.5.Z.HT	02.2	Endurecidos e temperados	2050	350	230-190-150	160-135-110	265-185-140	240-170-125
P3.0.Z.AN	03.11	Aços alta-liga (elementos de liga $> 5\%$) Recozidos	1950	200	395-330-250	260-215-175	445-295-215	405-270-200
P3.0.Z.HT	03.21	Aços-ferramenta endurecidos	3000	325	195-165-130	140-115-90	220-140-105	200-130-95
P1.5.C.UT	06.1	Aços fundidos Sem liga	1550	180	260-215-175	225-185-145	335-235-185	300-215-170
P2.6.C.UT	06.2	Baixa-liga (elementos de liga $\leq 5\%$)	1600	200	270-225-170	175-145-105	290-205-155	260-185-140
P3.0.C.UT	06.3	Alta-liga (elementos de liga $> 5\%$)	2050	225	200-165-125	140-115-85	225-150-115	205-135-105
ISO M	No. CMC	Aços inoxidáveis	Força de corte específica k_{c1}	Dureza Brinell	<<<< RESISTÊNCIA AO DESGASTE			
					GC1115	GC1125	GC2015	GC2220
					h_{ex} , mm \approx avanço f_n , mm/r			
					0.1-0.2-0.3	0.1-0.2-0.3	0.2-0.4-0.6	0.2-0.4-0.6
N° MC	No. CMC	Material	N/mm ²	HB	Velocidade de corte (V_c) m/min			
P5.0.Z.AN	05.11	Ferríticos/martensíticos Barras/forjados Não endurecidos	1800	200	335-255-200	280-215-170	260-220-200	-
P5.0.Z.PH	05.12	Endurecidos PH	2850	330	185-150-120	155-125-100	125-100-80	-
P5.0.Z.HT	05.13	Endurecidos	2350	330	200-160-140	165-135-120	145-120-85	-
M1.0.Z.AQ	05.21	Austeníticos Barras/forjados Austeníticos	1800	180	265-215-165	220-180-135	290-240-190	225-165-125
M1.0.Z.PH	05.22	Endurecidos PH	2850	330	185-150-120	155-125-100	130-100-80	100-70-55
M2.0.Z.AQ	05.23	Super austeníticos	2250	200	220-190-155	185-160-130	160-135-100	130-100-75
M3.1.Z.AQ	05.51	Austeníticos-ferríticos (Duplex) Barras/forjados Não-soldáveis $\geq 0.05\%C$	2000	230	250-205-155	210-170-130	220-185-145	190-150-110
M3.2.Z.AQ	05.52	Soldáveis $< 0.05\%C$	2450	260	230-170-130	190-140-110	190-150-120	150-120-90
P5.0.C.UT	15.11	Ferríticos/martensíticos Fundidas Não endurecidos	1700	200	320-265-205	265-220-170	250-210-170	-
P5.0.C.UT	15.12	Endurecidos PH	2450	330	160-130-95	135-110-80	100-70-55	-
P5.0.C.HT	15.13	Endurecidos	2150	330	175-145-110	145-120-90	110-90-60	-
M1.0.C.UT	15.21	Austeníticos Fundidas Austeníticos	1700	180	280-225-170	230-185-145	220-180-140	200-155-115
M1.0.C.UT	15.22	Endurecidos PH	2450	330	160-130-95	135-110-80	105-80-60	85-55-40
M2.0.C.AQ	15.23	Super austeníticos	2150	200	210-180-150	175-150-125	145-115-95	130-90-65
M3.1.C.AQ	15.51	Austeníticos-ferríticos (Duplex) Fundidas Não-soldáveis $\geq 0.05\%C$	1800	230	230-170-120	190-140-100	185-150-135	150-120-90
M3.2.C.AQ	15.52	Soldáveis $< 0.05\%C$	2250	260	205-155-110	170-130-90	160-140-105	125-105-80
ISO K	No. CMC	Ferros fundidos	Força de corte específica k_{c1}	Dureza Brinell	<<<< RESISTÊNCIA AO DESGASTE			
					CB7525	CB7925	CC6190	CC650
					h_{ex} , mm \approx avanço f_n , mm/r			
					0.1-0.25-0.4	0.1-0.25-0.4	0.2-0.4-0.6	0.1-0.25-0.4
N° MC	No. CMC	Material	N/mm ²	HB	Velocidade de corte (V_c) m/min			
K1.1.C.NS	07.1	Ferros fundidos maleáveis Ferríticos (cavacos curtos)	790	130	-	-	810-660-550	800-700-600
K1.1.C.NS	07.2	Perlíticos	900	230	-	-	700-660-550	700-600-500
K2.1.C.UT	08.1	Ferros fundidos cinzentos Baixa resistência à tensão	890	180	1700-1450-1200	1450-1200-1050	890-720-600	800-700-600
K2.2.C.UT	08.2	Alta resistência à tensão	970	220	1450-1250-1050	1250-1050-890	790-620-500	760-650-540
K3.1.C.UT	09.1	Ferros nodulares SG Ferríticos	900	160	-	-	-	610-550-450
K3.3.C.UT	09.2	Perlíticos	1350	250	-	-	-	510-450-350
K3.4.C.UT	09.3	Martensíticos	2100	380	-	-	-	350-305-260

Recomendações de velocidade de corte

TENACIDADE >>>>										
CC6160	GC4335									
0.1-0.4-0.8	0.1-0.4-0.8									
510-345-245 455-305-215 425-290-205	425-275-200 380-245-180 365-235-170									
460-305-215 395-265-190 255-180-140 205-145-110	300-185-135 250-155-110 185-120-85 150-95-70									
300-205-150 135-95-75	240-155-105 110-70-50									
240-180-130 210-140-100 185-125-90	185-140-100 165-100-70 145-95-65									
TENACIDADE >>>>										
GC2025	GC2035									
0.2-0.4-0.6	0.2-0.4-0.6									
225-175-130 100-70-45 115-80-55	180-160-130 85-65-45 95-70-50									
190-145-110 100-70-55 130-100-75	170-145-115 85-65-45 100-90-70									
135-100-70 100-70-50	160-135-105 130-110-85									
160-125-90 100-70-45 115-80-55	170-145-115 70-50-40 75-60-50									
170-135-100 85-55-40 130-90-65	150-120-95 70-50-40 100-80-60									
115-85-60 100-70-50	130-110-85 105-95-75									
TENACIDADE >>>>										
GC3210	GC3225	H13A								
0.2-0.4-0.6	0.2-0.4-0.6	0.1-0.3-0.5								
385-315-265 315-255-215	260-215-185 210-175-150	140-125-110 125-110-90								
445-360-305 355-290-245	300-250-210 240-200-170	180-145-110 140-115-95								
360-305-250 325-275-225 245-210-170	240-195-165 215-175-150 165-135-115	135-125-95 125-115-90 100-85-65								

B

C

D

E

F

G

H

Recomendações de velocidade de corte

As recomendações são válidas para uso com refrigeração.

ISO N	No. CMC	Materiais não ferrosos	Força de corte específica k_{c1}	Dureza Brinell	<<<< RESISTÊNCIA AO DESGASTE		
					CD05	CD10	H10
					h_{ex} mm \approx avanço f_n mm/r		
					Velocidade de corte (V_c) m/min		
N1.2.Z.UT N1.2.Z.AG	30.11 30.12	Ligas de alumínio Forjadas ou forjadas e trabalhadas a frio, não-envelhecidas Forjadas ou forjadas e envelhecidas	400 650	60 100	- -	2 000 (2500-250) ¹⁾ 2 000 (2500-250) ¹⁾	2 000 (2500-250) ¹⁾ 2 000 (2500-250) ¹⁾
N1.3.C.UT N1.3.C.AG		Ligas de alumínio Fundidas, não-envelhecidas Fundidos ou fundidos e envelhecidos	600 700	75 90	2 000 (2500-250) ¹⁾ 2 000 (2500-250) ¹⁾	2 000 (2500-250) ¹⁾ 2 000 (2500-250) ¹⁾	2 000 (2500-250) ¹⁾ 2 000 (2500-250) ¹⁾
N1.4.C.NS	30.41 30.42	Ligas de alumínio Fundidas, 13-15% Si Fundidas, 16-22% Si	700 700	130 130	1 550 (1950-195) ¹⁾ 770 (960-95) ¹⁾	1 550 (1950-195) ¹⁾ 770 (960-95) ¹⁾	450 (560-55) ¹⁾ 300 (375-38) ¹⁾
N3.3.U.UT N3.2.C.UT N3.1.U.UT	33.1 33.2 33.3	Cobre e ligas de cobre Ligas de corte livre, $\geq 1\%$ Pb Latão, bronzes com chumbo, $\leq 1\%$ Pb Bronze e cobre sem chumbo incl. cobre eletrolítico	550 550 1350	110 90 100	- - -	500 (630-65) ¹⁾ 500 (630-65) ¹⁾ 300 (375-38) ¹⁾	500 (630-65) ¹⁾ 500 (630-65) ¹⁾ 300 (375-38) ¹⁾
ISO S	No. CMC	Material resistente ao calor	Força de corte específica k_{c1}	Dureza Brinell	<<<< RESISTÊNCIA AO DESGASTE		
					CC6160	CC6060	CC6065
					h_{ex} mm \approx avanço f_n mm/r		
					Velocidade de corte (V_c) m/min		
S1.0.U.AN S1.0.U.AG	20.11 20.12	Super ligas resistentes ao calor À base de ferro Recozidas ou tratadas em solução Envelhecidas ou tratadas em solução e envelhecidas	2400 2500	200 280	- -	- -	- -
S2.0.Z.AN S2.0.Z.AG S2.0.C.NS	20.21 20.22 20.24	À base de níquel Recozidas ou tratadas em solução Envelhecidas ou tratadas em solução e envelhecidas Fundidos ou fundidos e envelhecidos	2650 2900 3000	250 350 320	400-325-270 300-235-190 240-205-175	400-325-270 300-235-190 240-205-175	330-255-200 240-175-130 215-180-150
S3.0.Z.AN S3.0.Z.AG S3.0.C.NS	20.31 20.32 20.33	Ligas à base de cobalto Recozidas ou tratadas em solução Tratadas em solução e envelhecidas Fundidos ou fundidos e envelhecidos	2700 3000 3100	200 300 320	- - -	- - -	- - -
S4.1.Z.UT S4.2.Z.AN S4.3.Z.AG	23.1 23.21 23.22	Ligas de titânio2) Comercial puro (99,5% Ti) α , α próximo e ligas $\alpha + \beta$, recozidas ligas $\alpha + \beta$ em condições envelhecidas. Ligas β . Recozidas ou envelhecidas.	1300 1400 1400	400 950 1050	- - -	- - -	- - -
ISO H	No. CMC	Materiais endurecidos	Força de corte específica k_{c1}	Dureza	<<<< RESISTÊNCIA AO DESGASTE		
					CC6050	CB7105	CB7115
					h_{ex} mm \approx avanço f_n mm/r		
					Velocidade de corte (V_c) m/min		
H1.1.Z.HA H1.1.Z.HA H1.2.Z.HA	04.1 04.1 04.1	Aços duros Endurecidos e temperados	2500 3050 3650	45HRC 50HRC 55HRC	290-235-175 240-195-145 200-165-120	- 395-300-250 330-250-210	- 350-265-225 295-225-185
H1.3.Z.HA H1.4.Z.HA	04.1 04.1	Aços extra-duros Endurecidos e temperados	4300 5000	60HRC 65HRC	170-140-105 145-120-90	280-215-180 240-185-155	250-190-160 215-165-135
H2.0.C.UT	10.1	Ferros fundidos coquilhados Fundidos ou fundidos e envelhecidos	2250	400 HB	-	-	-

1) As velocidades de corte, mostradas na tabela, são válidas para todos os avanços dentro da faixa de avanço.

2) Deve ser usado um ângulo de posição de 45-60°, geometria positiva de corte e refrigeração.

3) Rm = Limite de resistência à tração medido em MPa.

Recomendações de velocidade de corte

TENACIDADE >>>>									
H13A									
0.15-0.8									
1 900 (2400-240) ¹⁾									
1 900 (2400-240) ¹⁾									
1 900 (2400-240) ¹⁾									
1 900 (2400-240) ¹⁾									
400 (500-50) ¹⁾									
250 (315-31) ¹⁾									
450 (560-55) ¹⁾									
450 (560-55) ¹⁾									
270 (340-34) ¹⁾									

B

C

TENACIDADE >>>>									
CC650	CC670	S05F	GC1105	GC1115	GC1125	H13A			
0.1-0.2									
0.1-0.2-0.3									
0.1-0.2-0.3									
0.1-0.3-0.5									
0.1-0.3-0.5									
0.1-0.2-0.5									
0.1-0.3-0.5									
-	-	160-135-110	150-100-70	120-80-55	75-60-45	80-65-50			
-	-	125-105-85	120-80-60	95-65-50	55-45-35	60-50-40			
400-320	385-315-20	100-85-70	90-55-30	70-45-24	45-35-25	50-40-30			
340-265	325-270-230	90-75-60	80-50-27	65-40-22	35-25-15	40-30-20			
220-160	295-245-210	80-65-55	70-45-24	60-37-19	23-17-12	25-20-15			
345-260	345-255-205	100-85-70	90-60-30	70-45-24	45-35-25	50-40-30			
300-225	300-225-175	90-75-60	80-50-27	65-40-21	35-25-15	40-30-20			
285-225	285-225-170	80-65-55	70-45-24	60-37-19	23-17-12	25-20-15			
-	-	-	-	0.1-0.3-0.5	0.1-0.3-0.5	0.1-0.3-0.5			
-	-	-	-	185-155-130	-	50-40-30			
-	-	-	-	80-65-50	-	40-30-20			
-	-	-	-	75-55-45	-	25-20-15			

D

E

TENACIDADE >>>>									
CB7015	CB7025	CB7525	CB7125	CB7135					
0.05-0.15-0.25									
0.05-0.15-0.25									
0.1-0.25-0.4									
0.05-0.30									
0.05-0.40									
-	-	-							
350-265-225	250-210-185	205-165-135							
295-225-185	210-175-155	175-140-110							
250-190-160	180-150-135	145-120-95	200-150-100	160-120-80					
215-165-135	155-130-115	125-100-80							
-	-	180-150-120							

F

G

H

Dados de corte

CoroTurn® Prime



SBW = Longitudinal sentido reverso



EBW = Radial sentido reverso

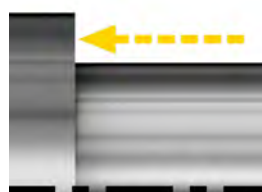

SFW = Longitudinal sentido à placa



EFW = Radial sentido ao centro

C Pastilhas tipo A com fixação por parafuso no suporte



	SBW	EBW	SFW	EFW
f_n mín	0.20	0.20	0.10	0.10
f_n rec	0.40	0.40	0.20	0.20
f_n máx	0.50	0.50	0.25	0.25
a_p mín	0.25	0.25	0.25	0.25
a_p rec	1.50	1.50	1.00	1.00
a_p máx	3.00	2.50	1.50	1.50
KAPR	30°	25°	115°	120°
RMPX	15°	10°	15°	10°
$D_{\min 3}$		30		0

Velocidade de corte

Material	v_c m/min
P	250-350
M	100-250
S	40-120

D Pastilhas tipo B com fixação rígida no suporte



	SBW	EBW	SFW	EFW
f_n mín	0.30	0.30	0.20	0.20
f_n rec	0.60	0.60	0.35	0.30
f_n máx	1.20	1.20	0.60	0.60
a_p mín	0.50	0.50	0.50	0.50
a_p rec	2.00	1.00	2.00	2.00
a_p máx	4.00	1.50	3.00	3.00
KAPR	25°	25°	95°	95°
RMPX	23°	23°	23°	23°
$D_{\min 3}$		40		0

E Diâmetro mínimo

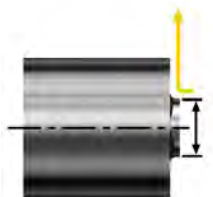

D_{\min} ; 30 mm para tipo A, 40 mm para tipo B

F Redução do avanço e entrada radial necessárias

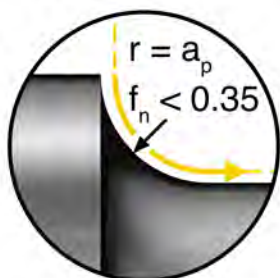
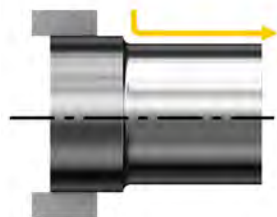

Avanço e profundidade de corte recomendados

Pastilha T-Max® P para torneamento

Pastilha	Profundidade de corte			Avanço de corte			Pastilha	Profundidade de corte			Avanço de corte		
	Rec	$a_p = \text{mm}$ Min.	Máx	Rec	$f_n = \text{mm/r}$ Min.	Máx		Rec	$a_p = \text{mm}$ Min.	Máx	Rec	$f_n = \text{mm/r}$ Min.	Máx
CNGA090304S01030A	0.1	0.07	0.4	0.1	0.05	0.2	CNGA160612T02520	4.8	0.1	8	0.3	0.15	0.54
CNGA090304S01030AWH	0.1	0.07	0.4	0.18	0.05	0.25	CNGA160616T02520	4.8	0.1	8	0.4	0.15	0.6
CNGA090304T01030AWH	0.1	0.07	0.4	0.18	0.05	0.25	CNGA190616T02520	5.7	0.1	9.5	0.4	0.15	0.6
CNGA090308S01030A	0.2	0.07	0.8	0.15	0.05	0.3	CNGG120401-SGF	0.1	0.05	3	0.03	0.01	0.08
CNGA090308S01030AWH	0.1	0.07	0.8	0.28	0.05	0.35	CNGG120402-SGF	0.2	0.08	3	0.04	0.02	0.1
CNGA090308S02035A	0.2	0.07	0.8	0.15	0.05	0.3	CNGG120404-SGF	0.3	0.1	3	0.12	0.05	0.25
CNGA090308T01030AWH	0.1	0.07	0.8	0.28	0.05	0.35	CNGG120408-SGF	0.5	0.2	3	0.15	0.1	0.3
CNGA120404S01020A	0.1	0.07	0.4	0.1	0.05	0.2	CNGG120412-SGF	0.8	0.3	4	0.18	0.1	0.35
CNGA120404S01020H	0.1	0.07	0.2	0.1	0.05	0.2	CNGQ120708T02520	3.6	0.1	6	0.2	0.15	0.36
CNGA120404S01030A	0.1	0.07	0.4	0.1	0.05	0.2	CNGQ120708T02520WG	3.6	0.1	6	0.3	0.15	0.36
CNGA120404S01030AWH	0.1	0.07	0.4	0.18	0.05	0.25	CNGQ120712T02520	3.6	0.1	6	0.3	0.15	0.54
CNGA120404S01525	0.1	0.1	0.5	0.1	0.05	0.2	CNGQ120712T02520WG	3.6	0.1	6	0.45	0.15	0.54
CNGA120404S01525H	0.1	0.07	0.2	0.1	0.05	0.2	CNGQ120716T02520	3.6	0.1	6	0.4	0.15	0.6
CNGA120404S01525WH	0.1	0.1	0.5	0.1	0.05	0.3	CNGX1204L025-18AXA	0.20	0.15	0.25	0.35	0.25	0.45
CNGA120404S02035A	0.2	0.07	0.4	0.15	0.05	0.3	CNGX1204L025-18HXA	0.20	0.15	0.25	0.35	0.25	0.45
CNGA120404S02035B	0.2	0.07	0.4	0.15	0.05	0.3	CNGX120712T02520	3.6	0.1	6	0.3	0.15	0.54
CNGA120404T01020B	0.1	0.07	0.4	0.1	0.05	0.2	CNGX120716T02520	3.6	0.1	6	0.4	0.15	0.6
CNGA120404T01020BWG	0.1	0.07	0.4	0.18	0.05	0.25	CNMA120404-KR	2.5	0.2	5	0.2	0.1	0.3
CNGA120404T01030AWH	0.1	0.07	0.4	0.18	0.05	0.25	CNMA120408-KR	4	0.2	8	0.35	0.15	0.6
CNGA120408EA	0.15	0.07	0.8	0.1	0.05	0.2	CNMA120412-KR	4	0.3	8	0.45	0.2	0.8
CNGA120408S01018A	0.15	0.07	0.8	0.15	0.05	0.3	CNMA120416-KR	4	0.3	8	0.55	0.2	1
CNGA120408S01020H	0.2	0.07	0.4	0.15	0.05	0.3	CNMA160612-KR	5	0.3	10	0.45	0.2	0.8
CNGA120408S01030A	0.2	0.07	0.8	0.15	0.05	0.3	CNMA160616-KR	5	0.3	10	0.55	0.2	1
CNGA120408S01030AWG	0.1	0.07	0.8	0.28	0.05	0.35	CNMA190608-KR	6	0.2	12	0.35	0.15	0.6
CNGA120408S01030AWH	0.1	0.07	0.8	0.28	0.05	0.35	CNMA190612-KR	6	0.3	12	0.45	0.2	0.8
CNGA120408S01520HWG	0.1	0.07	0.4	0.28	0.05	0.35	CNMA190616-KR	6	0.3	12	0.55	0.2	1
CNGA120408S01520HWH	0.1	0.07	0.4	0.28	0.05	0.35	CNMA190624-KR	6	0.4	12	0.6	0.2	1.19
CNGA120408S01525	0.2	0.1	1	0.1	0.05	0.3	CNMG090304-MF	0.4	0.1	1.5	0.15	0.05	0.25
CNGA120408S01525H	0.2	0.07	0.4	0.15	0.05	0.3	CNMG090304-MM	1.5	0.15	4	0.25	0.1	0.4
CNGA120408S01525WH	0.1	0.1	1	0.15	0.05	0.35	CNMG090304-PF	0.4	0.25	1.5	0.15	0.07	0.3
CNGA120408S01530B	0.15	0.1	1	0.15	0.05	0.3	CNMG090304-PM	2	0.4	4	0.2	0.1	0.3
CNGA120408S02030H	0.2	0.07	0.4	0.15	0.05	0.3	CNMG090304-QM	3	1	4.5	0.25	0.18	0.3
CNGA120408S02035A	0.2	0.07	0.8	0.15	0.05	0.3	CNMG090304-WF	0.5	0.3	1.5	0.15	0.05	0.25
CNGA120408S02035AWH	0.1	0.05	0.4	0.2	0.05	0.35	CNMG090308-MF	0.4	0.1	1.5	0.2	0.1	0.35
CNGA120408S02035B	0.2	0.07	0.8	0.15	0.05	0.3	CNMG090308-MM	2	0.5	4	0.25	0.1	0.4
CNGA120408T01020	1.2	0.1	3.6	0.1	0.07	0.2	CNMG090308-PF	0.4	0.3	1.5	0.15	0.1	0.3
CNGA120408T01020B	0.15	0.07	0.8	0.15	0.05	0.3	CNMG090308-PM	2	0.5	4	0.3	0.15	0.5
CNGA120408T01020BWG	0.1	0.07	0.8	0.28	0.05	0.35	CNMG090308-QM	3	1	4.5	0.35	0.2	0.5
CNGA120408T01020WG	3.6	0.1	6	0.25	0.15	0.36	CNMG090308-WF	1	0.3	2	0.3	0.1	0.3
CNGA120408T01030A	0.2	0.07	0.8	0.15	0.05	0.3	CNMG120404-KF	0.5	0.15	2	0.15	0.08	0.25
CNGA120408T01030AWH	0.1	0.07	0.8	0.28	0.05	0.35	CNMG120404-MF	0.4	0.1	1.5	0.15	0.05	0.3
CNGA120408T01525	0.2	0.1	1	0.1	0.05	0.3	CNMG120404-PF	0.4	0.25	1.5	0.15	0.07	0.3
CNGA120408T01525WH	0.2	0.1	1	0.15	0.05	0.35	CNMG120404-PM	3	0.4	5.5	0.2	0.1	0.3
CNGA120408T02520	3	2	4	0.5	0.3	0.56	CNMG120404-QM	3	1	6	0.25	0.18	0.3
CNGA120412EA	0.15	0.07	1.2	0.1	0.05	0.2	CNMG120404-SF	0.4	0.15	1.5	0.12	0.08	0.22
CNGA120412S01018A	0.2	0.07	1.2	0.2	0.05	0.4	CNMG120404-SM	1.5	0.15	2.5	0.2	0.1	0.3
CNGA120412S01020H	0.2	0.07	0.6	0.2	0.05	0.3	CNMG120404-WF	0.4	0.25	3	0.25	0.05	0.25
CNGA120412S01030A	0.2	0.07	1.2	0.2	0.05	0.3	CNMG120404-XF	0.75	0.15	4	0.15	0.05	0.2
CNGA120412S01030AWG	0.2	0.07	1.2	0.32	0.05	0.4	CNMG120404-XM	2.5	0.3	5	0.18	0.08	0.3
CNGA120412S01030AWH	0.2	0.07	1.2	0.32	0.05	0.4	CNMG120408-KF	0.5	0.15	2	0.2	0.1	0.3
CNGA120412S01520HWG	0.2	0.07	0.6	0.32	0.05	0.4	CNMG120408-KM	3	0.2	6	0.35	0.15	0.5
CNGA120412S01520HWH	0.2	0.07	0.6	0.32	0.05	0.4	CNMG120408-KR	3.5	0.38	7	0.38	0.19	0.53
CNGA120412S01525	0.3	0.1	1.5	0.15	0.05	0.35	CNMG120408-MF	0.4	0.1	1.5	0.2	0.1	0.4
CNGA120412S01525H	0.2	0.07	0.6	0.2	0.05	0.3	CNMG120408-MM	3	0.5	5.7	0.25	0.1	0.45
CNGA120412S01525WH	0.3	0.1	1.5	0.2	0.05	0.35	CNMG120408-MR	3	2	7.6	0.3	0.15	0.55
CNGA120412S01530B	0.2	0.1	1.5	0.2	0.05	0.3	CNMG120408-PF	0.4	0.3	1.5	0.2	0.1	0.4
CNGA120412S02030H	0.2	0.07	0.6	0.2	0.05	0.3	CNMG120408-PM	3	0.5	5.5	0.3	0.15	0.5
CNGA120412S02035A	0.2	0.07	1.2	0.2	0.05	0.3	CNMG120408-PR	4	0.7	7	0.35	0.2	0.5
CNGA120412S02035B	0.2	0.07	1.2	0.2	0.05	0.3	CNMG120408-QM	3	1	6	0.35	0.2	0.5
CNGA120412T01020	1.2	0.1	3.6	0.14	0.07	0.3	CNMG120408-SF	0.5	0.2	1.5	0.15	0.1	0.25
CNGA120412T01020B	0.2	0.07	1.2	0.2	0.05	0.4	CNMG120408-SM	2	0.2	3	0.25	0.1	0.35
CNGA120412T01020WG	3.6	0.1	6	0.45	0.15	0.54	CNMG120408-SMR	2	0.5	4	0.3	0.1	0.4
CNGA120412T01030A	0.2	0.07	1.2	0.2	0.05	0.3	CNMG120408-WF	1	0.25	4	0.3	0.1	0.5
CNGA120412T01030AWH	0.2	0.07	1.2	0.32	0.05	0.4	CNMG120408-WMX	3	0.5	5	0.45	0.15	0.7
CNGA120412T02520	3	2	4	0.5	0.3	0.6	CNMG120408-XF	1	0.2	4	0.2	0.05	0.25
CNGA120416S01030A	0.6	0.07	1.6	0.5	0.05	0.5	CNMG120408-XM	2.5	0.5	5	0.25	0.1	0.4
CNGA120416S01030A	0.6	0.07	1.6	0.5	0.05	0.7	CNMG120408-XMR	3	0.5	6	0.3	0.15	0.5
CNGA120416S01525H	0.2	0.07	0.8	0.2	0.05	0.5	CNMG120412-KF	1	0.2	2.5	0.25	0.1	0.35
CNGA120416S02035A	0.2	0.07	1.6	0.2	0.05	0.3	CNMG120412-KM	3	0.3	6	0.4	0.15	0.6
CNGA120416T01020	1.2	0.1	3.6	0.19	0.07	0.3	CNMG120412-KR	3.5	0.5	7	0.5	0.25	0.7
CNGA120416T01020WG	3.6	0.1	6	0.6	0.15	0.6	CNMG120412-MF	0.8	0.2	2.5	0.25	0.15	0.5
CNGA120416T02520	3	2	4	0.5	0.3	0.6	CNMG120412-MM	3	0.5	5.7	0.3	0.1	0.6
CNGA160608T01020	1.6	0.1	4.8	0.1	0.07	0.2	CNMG120412-MR	3	2	7.6	0.35	0.15	0.6
CNGA160612T01020	1.6	0.1	4.8	0.14	0.07	0.3	CNMG120412-PF	0.8	0.35	1.5	0.25	0.15	0.5

Avanço e profundidade de corte recomendados

Pastilha T-Max® P para torneamento

Pastilha	Profundidade de corte			Avanço de corte		
	Rec	$a_p = \text{mm}$		Rec	$f_n = \text{mm/r}$	
		Min.	Máx		Min.	Máx
CNMG120412-PM	3	0.8	5.5	0.35	0.18	0.6
CNMG120412-PR	4	1	7	0.4	0.25	0.7
CNMG120412-QM	3	1	6	0.35	0.25	0.6
CNMG120412-SF	0.8	0.4	2	0.17	0.12	0.3
CNMG120412-SM	2	0.3	3.5	0.28	0.12	0.38
CNMG120412-SMR	2	0.5	4	0.32	0.12	0.42
CNMG120412-WF	1.5	0.4	4	0.5	0.2	0.6
CNMG120412-WM	3.5	0.8	6	0.5	0.2	0.9
CNMG120412-WMX	3.5	0.8	6	0.5	0.2	0.75
CNMG120412-XM	3	0.7	5	0.3	0.15	0.45
CNMG120412-XMR	3	0.75	6	0.32	0.18	0.55
CNMG120416-KM	3	0.3	6	0.45	0.2	0.7
CNMG120416-KR	3.5	0.75	7	0.61	0.28	0.85
CNMG120416-MR	3	2	7.6	0.4	0.15	0.7
CNMG120416-PM	3	1	5.5	0.4	0.23	0.65
CNMG120416-PR	4	1.5	7	0.5	0.32	0.75
CNMG120416-QM	3	1	6	0.4	0.3	0.65
CNMG120416-SMR	2	0.5	4	0.35	0.15	0.45
CNMG120416-XMR	3.5	1	6	0.35	0.21	0.6
CNMG160604-QM	3	1	8	0.25	0.18	0.3
CNMG160608-KM	4	0.2	8	0.35	0.15	0.5
CNMG160608-MM	4	0.5	7.2	0.25	0.1	0.45
CNMG160608-PM	4	0.5	7.2	0.3	0.15	0.5
CNMG160608-PR	5	0.7	8	0.35	0.2	0.5
CNMG160608-QM	3	1	8	0.35	0.2	0.5
CNMG160608-SM	3	0.5	8	0.3	0.17	0.5
CNMG160608-WM	3.5	0.7	6.5	0.4	0.2	0.7
CNMG160608-WMX	3	0.5	5	0.45	0.15	0.7
CNMG160612-KM	4	0.3	8	0.4	0.15	0.6
CNMG160612-KR	4.7	0.8	9.3	0.55	0.28	0.77
CNMG160612-MM	4	0.5	7.2	0.3	0.1	0.6
CNMG160612-MR	4	2	10	0.35	0.15	0.6
CNMG160612-PM	4	0.8	7.2	0.35	0.18	0.6
CNMG160612-PR	5	1	8	0.4	0.25	0.7
CNMG160612-QM	3	1	8	0.35	0.25	0.6
CNMG160612-SM	4	1	6	0.25	0.2	0.35
CNMG160612-WM	3.5	0.7	6.5	0.4	0.2	0.7
CNMG160612-WMX	3.5	0.8	6	0.5	0.2	0.75
CNMG160612-XMR	4	1	7	0.4	0.2	0.65
CNMG160616-KM	4	0.3	8	0.45	0.2	0.7
CNMG160616-KR	4.7	1	9.3	0.61	0.3	0.85
CNMG160616-MM	4	0.5	7.2	0.37	0.1	0.65
CNMG160616-MR	4	2	10	0.4	0.15	0.7
CNMG160616-PM	4	1	7.2	0.4	0.23	0.65
CNMG160616-PR	5	1.5	8	0.5	0.3	0.8
CNMG160616-QM	3	1	8	0.35	0.3	0.55
CNMG160616-SM	4	1	6	0.3	0.25	0.4
CNMG160616-SMR	4	1	6	0.4	0.3	0.5
CNMG160616-XMR	4	1	7	0.45	0.25	0.7
CNMG160624-PR	5	2	8	0.5	0.32	0.9
CNMG190604-QM	3	1	8	0.25	0.18	0.3
CNMG190608-MM	4	0.5	8.5	0.25	0.1	0.45
CNMG190608-PM	4	0.5	8.6	0.3	0.15	0.5
CNMG190608-PR	5	0.7	10	0.35	0.2	0.5
CNMG190608-QM	3	1	8	0.35	0.2	0.5
CNMG190608-SM	4	0.5	8	0.3	0.15	0.5
CNMG190612-KM	4.5	0.3	9	0.4	0.15	0.6
CNMG190612-KR	7	1	14	0.55	0.28	0.77
CNMG190612-MM	4	0.5	8.5	0.3	0.1	0.6
CNMG190612-MR	4	2	11.4	0.35	0.15	0.6
CNMG190612-PM	4	0.8	8.6	0.35	0.18	0.6
CNMG190612-PR	5	1	10	0.4	0.25	0.7
CNMG190612-QM	3	1	8	0.35	0.25	0.6
CNMG190612-SM	2	0.5	9	0.3	0.2	0.5
CNMG190612-SMR	6	1	9	0.35	0.25	0.42
CNMG190612-XMR	4	1	8.5	0.45	0.25	0.7
CNMG190616-KM	4.5	0.3	9	0.45	0.2	0.7
CNMG190616-KR	7	1.5	14	0.61	0.3	0.85
CNMG190616-MM	4	0.5	8.5	0.37	0.1	0.65
CNMG190616-MR	4	2	11.4	0.4	0.15	0.7
CNMG190616-PM	4	1	8.6	0.4	0.23	0.65
CNMG190616-PR	5	1.5	10	0.5	0.3	0.8
CNMG190616-QM	3	1	8	0.4	0.3	0.65

Pastilha	Profundidade de corte			Avanço de corte		
	Rec	$a_p = \text{mm}$		Rec	$f_n = \text{mm/r}$	
		Min.	Máx		Min.	Máx
CNMG190616-SM	6	1	9	0.3	0.25	0.4
CNMG190616-SMR	6	1	9	0.4	0.3	0.5
CNMG190624-MR	4	2	11.4	0.5	0.15	1
CNMG190624-PR	5	2	10	0.5	0.32	0.9
CNMM120408-MR	3	0.7	7.5	0.35	0.2	0.55
CNMM120408-PR	5	0.7	7.5	0.4	0.2	0.55
CNMM120412-MR	3	1	7.5	0.4	0.25	0.7
CNMM120412-PR	5	1	7.5	0.5	0.25	0.7
CNMM120416-MR	3	1.5	7.5	0.5	0.32	0.9
CNMM120416-PR	5	1.5	7.5	0.55	0.32	0.9
CNMM160608-PR	6	0.7	9.5	0.4	0.2	0.55
CNMM160612-MR	6	1.2	9.5	0.45	0.32	0.65
CNMM160612-PR	6	1	9.5	0.5	0.25	0.7
CNMM160616-MR	6	1.5	9.5	0.5	0.35	0.8
CNMM160616-PR	6	1.5	9.5	0.55	0.32	0.9
CNMM190612-MR	7	1.5	12	0.5	0.32	0.7
CNMM190612-PR	6	1	12	0.5	0.25	0.7
CNMM190616-MR	7	1.8	12	0.55	0.35	0.9
CNMM190616-PR	6	1.5	12	0.55	0.32	0.9
CNMM190624-MR	7	2.5	12	0.6	0.4	1.2
CNMM190624-PR	6	2	12	0.55	0.35	1.2
CNMX1204A1-SM	1	0.5	1.5	0.25	0.13	0.35
CNMX1204A2-SM	2	0.5	2.5	0.25	0.13	0.35
DNGA110404S01020A	0.1	0.07	0.4	0.1	0.05	0.2
DNGA110404S01030A	0.1	0.07	0.4	0.1	0.05	0.2
DNGA110404S01525H	0.1	0.07	0.2	0.1	0.05	0.2
DNGA110404T01020B	0.1	0.07	0.4	0.1	0.05	0.2
DNGA110408S01020A	0.15	0.07	0.8	0.15	0.05	0.3
DNGA110408S01030A	0.2	0.07	0.8	0.15	0.05	0.3
DNGA110408S01525H	0.2	0.07	0.4	0.15	0.05	0.3
DNGA110408S02035A	0.2	0.07	0.8	0.15	0.05	0.3
DNGA110408T01020B	0.15	0.07	0.8	0.15	0.05	0.3
DNGA110412S01030A	0.2	0.07	1.2	0.2	0.05	0.3
DNGA110412S01525H	0.2	0.07	0.6	0.2	0.05	0.3
DNGA150404S01020A	0.1	0.07	0.4	0.1	0.05	0.2
DNGA150404S01030A	0.1	0.07	0.4	0.1	0.05	0.2
DNGA150404S01525	0.1	0.1	0.5	0.1	0.05	0.2
DNGA150404S01525H	0.1	0.07	0.2	0.1	0.05	0.2
DNGA150404S02035A	0.2	0.07	0.4	0.15	0.05	0.3
DNGA150408A	0.15	0.07	0.8	0.1	0.05	0.2
DNGA150408S01020A	0.1	0.07	0.8	0.1	0.05	0.2
DNGA150408S01030A	0.2	0.07	0.8	0.15	0.05	0.3
DNGA150408S01030AWH	0.1	0.07	0.8	0.28	0.05	0.35
DNGA150408S01520HWH	0.2	0.07	0.6	0.32	0.05	0.4
DNGA150408S01525	0.2	0.1	1	0.1	0.05	0.3
DNGA150408S01525H	0.2	0.07	0.6	0.2	0.05	0.3
DNGA150408S01530B	0.2	0.1	0.8	0.15	0.05	0.3
DNGA150408S02030H	0.2	0.07	0.2	0.15	0.05	0.3
DNGA150408S02035A	0.2	0.07	0.4	0.15	0.05	0.3
DNGA150408S02035AWH	0.1	0.07	0.8	0.28	0.05	0.35
DNGA150408T01020	1.5	0.1	4.5	0.1	0.07	0.2
DNGA150408T01525	0.2	0.1	1	0.1	0.05	0.3
DNGA150408T02520	4.5	0.1	7.5	0.2	0.15	0.36
DNGA150412EA	0.15	0.07	1.2	0.1	0.05	0.2
DNGA150412S01030A	0.2	0.07	1.2	0.2	0.05	0.3
DNGA150412S01030AWH	0.2	0.07	1.2	0.32	0.05	0.4
DNGA150412S01520HWH	0.2	0.07	0.6	0.32	0.05	0.4
DNGA150412S01525	0.3	0.1	1.5	0.15	0.05	0.35
DNGA150412S01525H	0.2	0.07	0.6	0.2	0.05	0.3
DNGA150412S01530B	0.2	0.1	0.8	0.2	0.05	0.3
DNGA150412S02030H	0.2	0.07	0.6	0.2	0.05	0.3
DNGA150412S02035A	0.2	0.07	1.2	0.2	0.05	0.3
DNGA150412T01020	1.5	0.1	4.5	0.14	0.07	0.3
DNGA150412T02520	4.5	0.1	7.5	0.3	0.15	0.54
DNGA150416S01030A	0.6	0.07	1.6	0.5	0.05	0.7
DNGA150416S01525H	0.2	0.07	0.8	0.3	0.05	0.5
DNGA150416T01020	1.5	0.1	4.5	0.19	0.07	0.3
DNGA150604S01525	0.1	0.1	0.5	0.1	0.05	0.2
DNGA150608S01525	0.2	0.1	1	0.1	0.05	0.3
DNGA150608T01525	0.2	0.1	1	0.1	0.05	0.3
DNGA150612S01525	0.3	0.1	1.5	0.15	0.05	0.35
DNGG150401-SGF	0.1	0.05	3	0.03	0.01	0.08
DNGG150402-SGF	0.2	0.08	3	0.04	0.02	0.1

Avanço e profundidade de corte recomendados

Pastilha T-Max® P para torneamento

Pastilha	Profundidade de corte			Avanço de corte			Pastilha	Profundidade de corte			Avanço de corte		
	Rec	a_p = mm Mín.	Máx	Rec	f_n = mm/r Mín.	Máx		Rec	a_p = mm Mín.	Máx	Rec	f_n = mm/r Mín.	Máx
DNGG150404-SGF	0.3	0.1	3	0.12	0.05	0.2	DNMG150604-MF	0.4	0.1	1.5	0.15	0.05	0.3
DNGG150408-SGF	0.5	0.2	3	0.15	0.1	0.25	DNMG150604-PF	0.4	0.25	1.5	0.15	0.07	0.3
DNGG150412-SGF	0.8	0.3	3	0.18	0.1	0.3	DNMG150604-PM	3	0.4	6	0.2	0.1	0.3
DNGG150604-SGF	0.3	0.1	3	0.12	0.05	0.2	DNMG150604-QM	3	1	7.5	0.25	0.18	0.3
DNGG150608-SGF	0.5	0.2	3	0.15	0.1	0.25	DNMG150604R-K	2.5	0.7	5	0.22	0.14	0.3
DNGG150612-SGF	0.8	0.3	3	0.18	0.1	0.3	DNMG150604-SF	0.4	0.15	1.5	0.12	0.08	0.22
DNGQ150708T02520	4.5	0.1	7.5	0.2	0.15	0.36	DNMG150604-SM	1.5	0.15	2	0.2	0.1	0.25
DNGQ150712T02520	4.5	0.1	7.5	0.3	0.15	0.54	DNMG150604-XF	0.75	0.15	4	0.15	0.05	0.2
DNGQ150716T02520	4.5	0.1	7.5	0.4	0.15	0.6	DNMG150604-XM	2.5	0.5	5	0.25	0.1	0.35
DNMA150408-KR	3	0.2	6	0.35	0.15	0.6	DNMG150608-KF	0.5	0.15	2	0.2	0.1	0.3
DNMA150412-KR	3	0.3	6	0.45	0.2	0.8	DNMG150608-KM	2.5	0.2	5	0.35	0.15	0.5
DNMA150608-KR	3	0.2	6	0.35	0.15	0.6	DNMG150608-KR	3.5	0.38	7	0.34	0.17	0.47
DNMA150612-KR	3	0.3	6	0.45	0.2	0.8	DNMG150608L-K	3	0.8	5	0.3	0.14	0.5
DNMA150616-KR	3	0.3	6	0.55	0.2	1	DNMG150608L-M	0.4	0.1	1.5	0.2	0.1	0.4
DNMG110404-KF	0.5	0.15	2	0.15	0.08	0.25	DNMG150608-MM	3	0.5	6.4	0.25	0.1	0.45
DNMG110404-MF	0.4	0.1	1.5	0.15	0.05	0.3	DNMG150608-MR	3	2	6	0.3	0.15	0.55
DNMG110404-PF	0.4	0.25	1.5	0.15	0.07	0.3	DNMG150608-PF	0.4	0.3	1.5	0.2	0.1	0.4
DNMG110404-PM	2	0.4	5	0.2	0.1	0.3	DNMG150608-PM	3	0.5	6	0.3	0.15	0.5
DNMG110404-QM	3	1	5.5	0.25	0.18	0.3	DNMG150608-PR	4	0.7	6	0.35	0.2	0.5
DNMG110404-SF	0.4	0.15	1.5	0.12	0.08	0.22	DNMG150608-QM	3	1	7.5	0.35	0.2	0.5
DNMG110404-SM	1	0.4	4	0.15	0.1	0.3	DNMG150608R-K	3	0.8	5	0.3	0.14	0.5
DNMG110408-KF	0.5	0.15	2	0.2	0.1	0.3	DNMG150608-SF	0.5	0.2	1.5	0.15	0.1	0.25
DNMG110408-KM	2	0.2	3.5	0.35	0.15	0.5	DNMG150608-SM	2	0.2	2.5	0.22	0.1	0.28
DNMG110408-MF	0.4	0.1	1.5	0.2	0.1	0.4	DNMG150608-SMR	1.5	0.15	2.5	0.2	0.1	0.25
DNMG110408-MM	2	0.5	4.4	0.25	0.1	0.45	DNMG150608-XF	1	0.2	4	0.2	0.05	0.25
DNMG110408-PF	0.4	0.3	1.5	0.2	0.1	0.4	DNMG150608-XM	2.5	0.5	5	0.25	0.1	0.4
DNMG110408-PM	2	0.5	5	0.3	0.15	0.5	DNMG150612-KF	1	0.2	2.5	0.25	0.1	0.35
DNMG110408-QM	3	1	5.5	0.35	0.2	0.5	DNMG150612-KM	2.5	0.3	5	0.4	0.15	0.6
DNMG110408-SF	0.5	0.2	1.5	0.15	0.1	0.25	DNMG150612-KR	3.5	0.5	7	0.45	0.23	0.63
DNMG110412-KM	2	0.3	3.5	0.4	0.15	0.6	DNMG150612-MF	0.8	0.2	2.5	0.25	0.15	0.5
DNMG110412-MM	2	0.5	4.4	0.3	0.1	0.6	DNMG150612-MM	3	0.5	6.4	0.3	0.1	0.6
DNMG110412-PF	0.8	0.35	1.5	0.25	0.15	0.5	DNMG150612-MR	3	2	6	0.35	0.15	0.6
DNMG110412-PM	2	0.8	5	0.35	0.18	0.5	DNMG150612-PF	0.8	0.35	1.5	0.25	0.15	0.5
DNMG110412-QM	3	1	5.5	0.35	0.25	0.6	DNMG150612-PM	3	0.8	6	0.35	0.18	0.6
DNMG150404-KF	0.5	0.15	2	0.15	0.08	0.25	DNMG150612-PR	4	1	6	0.4	0.25	0.7
DNMG150404L-K	2.5	0.7	5	0.22	0.14	0.3	DNMG150612-QM	3	1	7.5	0.35	0.25	0.6
DNMG150404-MF	0.4	0.1	1.5	0.15	0.05	0.3	DNMG150612-SF	0.8	0.4	2	0.17	0.12	0.3
DNMG150404-PM	3	0.4	6	0.2	0.1	0.3	DNMG150612-SM	2	0.3	3	0.25	0.12	0.3
DNMG150404-QM	3	1	7.5	0.25	0.18	0.3	DNMG150612-SMR	2	0.2	3	0.22	0.1	0.3
DNMG150404R-K	2.5	0.7	5	0.22	0.14	0.3	DNMG150612-XM	3	0.7	5	0.28	0.15	0.45
DNMG150404-SF	0.4	0.15	1.5	0.12	0.08	0.22	DNMG150612-XMR	3	0.75	6	0.3	0.18	0.5
DNMG150404-SM	1.5	0.15	2	0.2	0.1	0.25	DNMG150616-KR	3.5	0.75	7	0.5	0.25	0.69
DNMG150404-XF	0.75	0.15	4	0.15	0.05	0.2	DNMG150616-MR	3	2	6	0.4	0.15	0.7
DNMG150404-XM	2.5	0.3	5	0.18	0.08	0.25	DNMG150616-PM	3	1	6	0.4	0.23	0.65
DNMG150408-KF	0.5	0.15	2	0.2	0.1	0.3	DNMG150616-PR	4	1.5	6	0.5	0.32	0.75
DNMG150408-KM	2.5	0.2	5	0.35	0.15	0.5	DNMG150616-QM	3	1	7.5	0.4	0.3	0.65
DNMG150408-KR	3.5	0.38	7	0.34	0.17	0.47	DNMG150616-SM	2	0.3	3	0.25	0.12	0.3
DNMG150408-MF	0.4	0.1	1.5	0.2	0.1	0.4	DNMG190608-PR	5	1	8	0.35	0.2	0.5
DNMG150408-MR	3	2	6	0.3	0.15	0.55	DNMG190612-PR	5	1.2	8	0.4	0.25	0.7
DNMG150408-PF	0.4	0.3	1.5	0.2	0.1	0.4	DNMM150608-MR	3	0.7	6	0.35	0.2	0.55
DNMG150408-PM	3	0.5	6	0.3	0.15	0.5	DNMM150608-PR	5	0.7	6	0.4	0.2	0.55
DNMG150408-PR	4	0.7	6	0.35	0.2	0.5	DNMM150612-MR	3	1	6	0.4	0.25	0.7
DNMG150408-QM	3	1	7.5	0.35	0.2	0.5	DNMM150612-PR	5	1	6	0.5	0.25	0.7
DNMG150408R-K	3	0.8	5	0.3	0.14	0.5	DNMM150616-PR	5	1.5	6	0.55	0.32	0.9
DNMG150408-SF	0.5	0.2	1.5	0.15	0.1	0.25	DNMX110404-WF	1	0.2	1.5	0.2	0.08	0.3
DNMG150408-SM	2	0.2	2.5	0.22	0.1	0.28	DNMX110408-WF	1	0.2	3	0.3	0.1	0.4
DNMG150408-SMR	1.5	0.15	2.5	0.2	0.1	0.25	DNMX110408-WM	1.5	0.5	3.5	0.35	0.15	0.5
DNMG150408-XF	1	0.2	4	0.2	0.05	0.25	DNMX110412-WM	2	0.5	4	0.45	0.15	0.6
DNMG150408-XM	2.5	0.5	5	0.25	0.1	0.4	DNMX150408-WM	2	0.5	4.5	0.35	0.15	0.5
DNMG150412-KM	2.5	0.3	5	0.4	0.15	0.6	DNMX150408-WMX	3	0.5	5	0.45	0.15	0.7
DNMG150412-KR	3.5	0.5	7	0.45	0.23	0.63	DNMX150412-WM	2.5	0.5	5	0.45	0.15	0.6
DNMG150412-MF	0.8	0.2	2.5	0.25	0.15	0.5	DNMX150412-WMX	3.5	0.8	6	0.5	0.2	0.75
DNMG150412-MR	3	2	6	0.35	0.15	0.6	DNMX150416-WM	3.5	0.5	6	0.6	0.2	0.8
DNMG150412-PF	0.8	0.35	1.5	0.25	0.15	0.5	DNMX150416-WMX	3.5	0.5	6	0.5	0.2	0.8
DNMG150412-PM	3	0.8	6	0.35	0.18	0.6	DNMX150604-WF	0.8	0.2	3	0.2	0.08	0.3
DNMG150412-PR	4	1	6	0.4	0.25	0.7	DNMX150608-WF	1.5	0.2	3	0.3	0.1	0.4
DNMG150412-QM	3	1	7.5	0.35	0.25	0.6	DNMX150608-WMX	3	0.5	5	0.45	0.15	0.7
DNMG150412-SM	2	0.3	3	0.25	0.12	0.3	DNMX150612-WF	1.5	0.4	3.5	0.4	0.15	0.55
DNMG150412-SMR	2	0.2	3	0.22	0.1	0.3	DNMX150612-WM	2.5	0.5	5	0.45	0.15	0.6
DNMG150416-MR	3	2	6	0.4	0.15	0.7	DNMX150612-WMX	3.5	0.8	6	0.5	0.2	0.75
DNMG150416-PR	4	1.5	6	0.5	0.3	0.75	DNMX150616-WM	3.5	0.5	6	0.6	0.2	0.8
DNMG150604-KF	0.5	0.15	2	0.15	0.08	0.25	DNMX150616-WMX	3.5	0.5	6	0.5	0.2	0.8
DNMG150604L-K	2.5	0.7	5	0.22	0.14	0.3	RCMX100300	2.5	1	4	0.16	0.06	0.32

Avanço e profundidade de corte recomendados

Pastilha T-Max® P para torneamento

Pastilha	Profundidade de corte			Avanço de corte		
	Rec	a_p = mm Mín. Máx		Rec	f_n = mm/r Mín. Máx	
RCMX100300E	2.5	1	4	0.16	0.06	0.32
RCMX120400	3	1.2	4.8	0.19	0.08	0.38
RCMX120400E	3	1.2	4.8	0.19	0.08	0.38
RCMX160600	4	1.6	6.4	0.25	0.1	0.51
RCMX200600	5	2	8	0.32	0.13	0.63
RNGA120400T01020	1.8	0.1	3.6	0.15	0.1	0.3
RNMG090300	2.25	0.9	4.5	0.14	0.06	0.28
RNMG090300	2.25	0.9	4.5	0.14	0.06	0.28
RNMG120400	3	1.2	4.8	0.18	0.07	0.37
RNMG120400	3	1.2	4.8	0.18	0.07	0.37
RNMG150600	3.75	1.5	7.5	0.23	0.1	0.46
RNMG190600	4.25	1.9	7.6	0.3	0.12	0.6
RNMG190600	4.25	1.9	7.6	0.3	0.12	0.6
RNMG190600-SM	4	2	8	0.45	0.15	0.5
SNGA090308S01030A	0.2	0.07	0.8	0.16	0.05	0.31
SNGA120408S01030A	0.2	0.07	0.8	0.16	0.05	0.31
SNGA120408S01525	0.2	0.1	1	0.1	0.05	0.31
SNGA120408T01020	1.2	0.1	3.6	0.1	0.07	0.21
SNGA120408T01020B	0.15	0.07	0.8	0.16	0.05	0.31
SNGA120408T01525	0.2	0.1	1	0.1	0.05	0.31
SNGA120408T02520	3	2	4	0.52	0.31	0.58
SNGA120412S01030A	0.2	0.07	1.2	0.21	0.05	0.31
SNGA120412S01525	0.3	0.1	1.5	0.16	0.05	0.36
SNGA120412S01525F	0.2	0.07	0.6	0.21	0.05	0.31
SNGA120412S02035A	0.2	0.07	1.2	0.16	0.05	0.31
SNGA120412S02035B	0.2	0.07	1.2	0.16	0.05	0.31
SNGA120412T01020	1.2	0.1	3.6	0.14	0.07	0.31
SNGA120412T01020B	0.2	0.07	1.2	0.21	0.05	0.41
SNGA120412T02520	3	2	4	0.52	0.31	0.62
SNGA120416T01020	1.2	0.1	3.6	0.2	0.07	0.31
SNGA120416T02520	3	2	4	0.52	0.31	0.62
SNGQ120708T02520	3.6	0.1	6	0.21	0.16	0.37
SNGQ120712T02520	3.6	0.1	6	0.31	0.16	0.56
SNGQ120716T02520	3.6	0.1	6	0.41	0.16	0.62
SNGX120712T02520	3.6	0.1	6	0.31	0.16	0.56
SNGX120716T02520	3.6	0.1	6	0.41	0.16	0.62
SNMA090308-KR	2.5	0.38	4.5	0.39	0.2	0.55
SNMA120408-KR	4	0.2	8	0.36	0.16	0.62
SNMA120412-KR	4	0.3	8	0.47	0.21	0.83
SNMA120416-KR	4	0.3	8	0.57	0.21	1.04
SNMA150612-KR	5	0.3	10	0.47	0.21	0.83
SNMA150616-KR	5	0.3	10	0.57	0.21	1.04
SNMA190608-KR	6	0.2	12	0.36	0.16	0.62
SNMA190612-KR	6	0.3	12	0.47	0.21	0.83
SNMA190616-KR	6	0.3	12	0.57	0.21	1.04
SNMG090304-PM	2	0.4	4.5	0.21	0.1	0.31
SNMG090304-QM	3	1	4.5	0.26	0.19	0.31
SNMG090308-KM	2.5	0.2	4.5	0.36	0.16	0.52
SNMG090308-PM	2	0.5	4.5	0.31	0.16	0.52
SNMG090308-QM	3	1	4.5	0.36	0.21	0.52
SNMG120404-MF	0.4	0.1	1.5	0.16	0.05	0.31
SNMG120404-PM	3	0.4	6	0.21	0.1	0.31
SNMG120404-QM	3	1	6	0.26	0.19	0.31
SNMG120404-SM	1.5	0.4	4	0.26	0.16	0.41
SNMG120408-KM	3	0.2	6	0.36	0.16	0.52
SNMG120408-KR	3.5	0.38	7	0.39	0.2	0.55
SNMG120408-MF	0.4	0.1	1.5	0.21	0.1	0.41
SNMG120408-MM	3	0.5	6.35	0.26	0.1	0.47
SNMG120408-MR	3	2	7.6	0.31	0.16	0.57
SNMG120408-PF	0.4	0.3	1.5	0.21	0.1	0.41
SNMG120408-PM	3	0.5	6	0.31	0.16	0.52
SNMG120408-PR	4	0.7	7	0.36	0.21	0.52
SNMG120408-QM	3	1	6	0.36	0.21	0.52
SNMG120408-SM	2	0.5	5	0.23	0.16	0.41
SNMG120408-SMR	2	0.5	5	0.26	0.16	0.41
SNMG120408-XM	3	0.5	6	0.31	0.12	0.52
SNMG120408-XMR	3	0.5	6	0.36	0.16	0.57
SNMG120412-KM	3	0.3	6	0.41	0.16	0.62
SNMG120412-KR	3.5	0.5	7	0.52	0.29	0.72
SNMG120412-MM	3	0.5	6.35	0.31	0.1	0.62
SNMG120412-MR	3	2	7.6	0.36	0.16	0.62
SNMG120412-PF	0.8	0.35	1.5	0.26	0.16	0.52
SNMG120412-PM	3	0.8	6	0.36	0.19	0.62

Pastilha	Profundidade de corte			Avanço de corte		
	Rec	a_p = mm Mín. Máx		Rec	f_n = mm/r Mín. Máx	
SNMG120412-PR	4	1	7	0.41	0.26	0.72
SNMG120412-QM	3	1	6	0.36	0.26	0.62
SNMG120412-SM	2	0.5	5	0.29	0.19	0.47
SNMG120412-SMR	2	0.5	5	0.31	0.19	0.47
SNMG120412-XMR	3	0.75	6	0.36	0.19	0.62
SNMG120416-KM	3	0.3	6	0.47	0.21	0.72
SNMG120416-KR	3.5	0.75	7	0.57	0.29	0.8
SNMG120416-MM	3	0.5	6.35	0.38	0.1	0.67
SNMG120416-PM	3	1	6	0.41	0.24	0.67
SNMG120416-PR	4	1.5	7	0.52	0.33	0.78
SNMG120416-QM	3	1	6	0.41	0.31	0.67
SNMG120416-SM	2	0.5	5	0.34	0.19	0.52
SNMG120416-SMR	2	0.5	5	0.36	0.19	0.52
SNMG150608-PR	5	1.5	8	0.36	0.21	0.52
SNMG150608-QM	3	1	8	0.36	0.21	0.52
SNMG150608-SM	3	0.5	8	0.31	0.18	0.52
SNMG150612-KM	4	0.3	8	0.41	0.16	0.62
SNMG150612-KR	4.4	0.63	8.8	0.57	0.29	0.8
SNMG150612-MM	4	0.5	8	0.31	0.1	0.62
SNMG150612-MR	4	2	9.6	0.36	0.16	0.62
SNMG150612-PM	4	0.8	7.5	0.36	0.19	0.62
SNMG150612-PR	5	1	8	0.41	0.26	0.72
SNMG150612-QM	3	1	8	0.36	0.26	0.62
SNMG150612-SM	5	1	8	0.31	0.21	0.41
SNMG150616-KM	4	0.3	8	0.47	0.21	0.72
SNMG150616-KR	4.4	0.94	8.8	0.63	0.31	0.88
SNMG150616-MM	4	0.5	8	0.38	0.1	0.67
SNMG150616-MR	4	2	9.6	0.41	0.16	0.72
SNMG150616-PM	4	1	7.5	0.41	0.24	0.67
SNMG150616-PR	5	1.5	8	0.52	0.31	0.83
SNMG150616-QM	5	1.5	8	0.52	0.31	0.83
SNMG150616-SM	5	1	8	0.36	0.26	0.47
SNMG150616-SMR	5	1	8	0.52	0.31	0.72
SNMG150624-PR	5	2	8	0.52	0.33	0.93
SNMG190608-PR	5	0.7	10	0.36	0.21	0.52
SNMG190608-QM	5	0.7	10	0.36	0.21	0.52
SNMG190612-KM	4.5	0.3	9	0.41	0.16	0.62
SNMG190612-MM	4	0.5	9.5	0.31	0.1	0.62
SNMG190612-MR	4	2	11.4	0.36	0.16	0.62
SNMG190612-PR	5	1	10	0.41	0.26	0.72
SNMG190612-QM	5	1	10	0.41	0.26	0.72
SNMG190612-SM	2	0.5	9	0.31	0.21	0.52
SNMG190612-SMR	6	1	9	0.36	0.26	0.43
SNMG190616-KM	4.5	0.3	9	0.47	0.21	0.72
SNMG190616-KR	6.1	1.31	12.3	0.63	0.31	0.88
SNMG190616-MM	4	0.5	9.5	0.38	0.1	0.67
SNMG190616-MR	4	2	11.4	0.41	0.16	0.72
SNMG190616-PR	5	1.5	10	0.52	0.31	0.83
SNMG190616-QM	3	1	8	0.41	0.31	0.67
SNMG190616-SM	7	2	10	0.36	0.26	0.47
SNMG190616-SMR	7	1	10	0.52	0.31	0.72
SNMG190624-MR	4	2	11.4	0.52	0.16	1.04
SNMG190624-PR	5	2	10	0.52	0.33	0.93
SNMM120408-MR	3	0.7	7.5	0.36	0.21	0.57
SNMM120408-PR	5	0.7	7.5	0.41	0.21	0.57
SNMM120412-MR	3	1	7.5	0.41	0.26	0.72
SNMM120412-PR	5	1	7.5	0.52	0.26	0.72
SNMM120416-MR	3	1.5	7.5	0.52	0.33	0.93
SNMM120416-PR	4	1	9	0.41	0.26	0.72
SNMM150612-PR	6	1	9	0.52	0.26	0.72
SNMM150616-MR	4	1.5	9	0.52	0.33	0.93
SNMM150616-PR	6	1.5	9	0.57	0.33	0.93
SNMM190612-MR	7	1.5	12	0.52	0.33	0.72
SNMM190612-PR	6	1	12	0.52	0.26	0.72
SNMM190616-MR	7	1.8	12	0.57	0.36	0.93
SNMM190616-PR	6	1.5	12	0.57	0.33	0.93
SNMM190624-MR	7	2.5	12	0.62	0.41	1.24
SNMM190624-PR	6	2	12	0.57	0.36	1.24
SNMM190632-MR	4	3.5	12	0.52	0.41	1.24
TNGA110304S01030A	0.1	0.07	0.4	0.1	0.05	0.2
TNGA110304T01020B	0.1	0.07	0.4	0.1	0.05	0.2
TNGA110308S01030A	0.2	0.07	0.8	0.15	0.05	0.3
TNGA110308T01020B	0.15	0.07	0.8	0.15	0.05	0.3

Avanço e profundidade de corte recomendados

Pastilha T-Max® P para torneamento

Pastilha	Profundidade de corte			Avanço de corte		
	$a_p = \text{mm}$			$f_n = \text{mm/r}$		
	Rec	Min.	Máx	Rec	Min.	Máx
TNGA160404S01030A	0.1	0.07	0.4	0.1	0.05	0.2
TNGA160404S01525	0.1	0.1	0.5	0.1	0.05	0.2
TNGA160404S01525H	0.1	0.07	0.2	0.1	0.05	0.2
TNGA160404T01020B	0.1	0.07	0.4	0.1	0.05	0.2
TNGA160408S01030A	0.2	0.07	0.8	0.15	0.05	0.3
TNGA160408S01525	0.2	0.1	1	0.1	0.05	0.2
TNGA160408S01530B	0.2	0.1	1	0.15	0.05	0.3
TNGA160408S02035A	0.2	0.07	0.8	0.15	0.05	0.3
TNGA160408S02035B	0.2	0.07	0.8	0.15	0.05	0.3
TNGA160408T01020	1.6	0.1	4.8	0.1	0.07	0.2
TNGA160408T01020B	0.15	0.07	0.8	0.15	0.05	0.3
TNGA160408T01525	0.2	0.1	1	0.1	0.05	0.3
TNGA160408T02520	3	2	4	0.5	0.3	0.56
TNGA160412S01030A	0.2	0.07	1.2	0.2	0.05	0.3
TNGA160412S01525	0.3	0.1	1.5	0.15	0.05	0.35
TNGA160412S01525H	0.2	0.07	0.6	0.21	0.05	0.31
TNGA160412S02035A	0.2	0.07	1.2	0.15	0.05	0.3
TNGA160412T01020	1.6	0.1	4.8	0.14	0.07	0.3
TNGA160412T01020B	0.2	0.07	0.6	0.2	0.05	0.4
TNGA160412T02520	3	2	4	0.5	0.3	0.6
TNGA220408T01020	2.2	0.1	6.6	0.1	0.07	0.2
TNGA220412T01020	2.2	0.1	6.6	0.14	0.07	0.3
TNGA220416T01020	2.2	0.1	6.6	0.19	0.07	0.3
TNMA160404-KR	2.5	0.2	5	0.2	0.1	0.3
TNMA160408-KR	3.5	0.2	7	0.35	0.15	0.6
TNMA160412-KR	3.5	0.3	7	0.45	0.2	0.8
TNMA160416-KR	3.5	0.3	7	0.55	0.2	1
TNMA220404-KR	2.5	0.2	10	0.2	0.1	0.3
TNMA220408-KR	5	0.2	10	0.35	0.15	0.6
TNMA220412-KR	5	0.3	10	0.45	0.2	0.8
TNMA220416-KR	5	0.3	10	0.55	0.2	1
TNMA220432-KR	5	0.5	10	0.6	0.5	1.19
TNMG160404-KF	0.5	0.15	2	0.15	0.08	0.25
TNMG160404L-K	2.5	0.7	5	0.22	0.14	0.3
TNMG160404-MF	0.4	0.1	1.5	0.15	0.05	0.3
TNMG160404-PF	0.4	0.25	1.5	0.15	0.07	0.3
TNMG160404-PM	3	0.4	5	0.2	0.1	0.3
TNMG160404-QM	2	0.4	4	0.25	0.18	0.3
TNMG160404R-K	2.5	0.7	5	0.22	0.14	0.3
TNMG160404-SF	0.4	0.15	1.5	0.12	0.08	0.22
TNMG160404-SM	1	0.4	4	0.15	0.1	0.3
TNMG160404-XF	0.75	0.15	4	0.15	0.05	0.2
TNMG160404-XM	2.5	0.3	5	0.18	0.08	0.3
TNMG160408-KF	0.5	0.15	2	0.2	0.1	0.3
TNMG160408-KM	3	0.2	5.5	0.35	0.15	0.5
TNMG160408-KR	3.2	0.34	6.2	0.3	0.17	0.42
TNMG160408L-K	3	0.8	5	0.3	0.14	0.5
TNMG160408-MF	0.4	0.1	1.5	0.2	0.1	0.4
TNMG160408-MM	3	0.5	4.8	0.25	0.1	0.45
TNMG160408-MR	3	2	5.6	0.3	0.15	0.55
TNMG160408-PF	0.4	0.3	1.5	0.2	0.1	0.4
TNMG160408-PM	3	0.5	5	0.3	0.15	0.5
TNMG160408-PR	3	0.7	6	0.35	0.2	0.55
TNMG160408-QM	3	1	5.6	0.35	0.2	0.5
TNMG160408R-K	3	0.8	5	0.3	0.14	0.5
TNMG160408-SF	0.5	0.2	1.5	0.15	0.1	0.25
TNMG160408-SM	2	0.2	3	0.22	0.1	0.28
TNMG160408-XF	1	0.2	4	0.2	0.05	0.25
TNMG160408-XM	2.5	0.5	5	0.25	0.1	0.4
TNMG160408-XMR	3	0.5	5	0.27	0.15	0.45
TNMG160412-KM	3	0.3	5.5	0.4	0.15	0.6
TNMG160412-KR	3.2	0.45	6.3	0.4	0.2	0.56
TNMG160412-MM	3	0.5	4.8	0.3	0.1	0.6
TNMG160412-MR	3	2	5.6	0.35	0.15	0.6
TNMG160412-PF	0.8	0.35	1.5	0.25	0.15	0.5
TNMG160412-PM	3	0.8	5	0.35	0.18	0.6
TNMG160412-PR	3	1	6	0.4	0.25	0.65
TNMG160412-QM	3	1	5.6	0.35	0.25	0.6
TNMG160412-SF	0.8	0.4	2	0.17	0.12	0.3
TNMG160412-SM	2	0.3	3	0.25	0.12	0.3
TNMG160412-XM	3	0.7	5	0.3	0.15	0.45
TNMG160412-XMR	3	0.75	5	0.3	0.18	0.48
TNMG160416-KR	3.2	0.68	6.2	0.44	0.22	0.62

Pastilha	Profundidade de corte			Avanço de corte		
	$a_p = \text{mm}$			$f_n = \text{mm/r}$		
	Rec	Min.	Máx	Rec	Min.	Máx
TNMG220404-PM	4	0.4	6.6	0.2	0.1	0.3
TNMG220404-QM	3	1	7.7	0.25	0.18	0.3
TNMG220408-KM	4	0.2	8	0.35	0.15	0.5
TNMG220408-KR	3.5	0.38	7	0.38	0.19	0.53
TNMG220408-MR	4	2	7.7	0.3	0.15	0.55
TNMG220408-PF	0.4	0.3	1.5	0.2	0.1	0.4
TNMG220408-PM	4	0.5	6.6	0.3	0.15	0.5
TNMG220408-PR	4	0.7	7	0.35	0.2	0.55
TNMG220408-QM	3	1	7.7	0.35	0.2	0.5
TNMG220408-SM	2	0.2	4	0.22	0.1	0.28
TNMG220412-KM	4	0.3	8	0.4	0.15	0.6
TNMG220412-KR	3.5	0.5	7	0.5	0.25	0.7
TNMG220412-MM	4	0.5	6.6	0.3	0.1	0.6
TNMG220412-MR	4	2	7.7	0.35	0.15	0.6
TNMG220412-PF	0.8	0.35	1.5	0.25	0.15	0.5
TNMG220412-PM	4	0.8	6.6	0.35	0.18	0.6
TNMG220412-PR	4	1	7	0.4	0.25	0.65
TNMG220412-QM	3	1	7.7	0.35	0.25	0.6
TNMG220412-SM	2	0.3	4	0.25	0.12	0.3
TNMG220416-KM	4	0.3	8	0.45	0.2	0.7
TNMG220416-MM	4	0.5	6.6	0.37	0.1	0.65
TNMG220416-MR	4	2	7.7	0.4	0.15	0.7
TNMG220416-PM	4	1	6.6	0.4	0.23	0.65
TNMG220416-PR	4	1.5	7	0.5	0.32	0.75
TNMG220416-QM	3	1	7.7	0.4	0.3	0.65
TNMM160408-MR	3	0.7	7.5	0.35	0.2	0.55
TNMM160408-PR	4	0.7	6	0.4	0.2	0.55
TNMM160412-PR	4	1	6	0.5	0.25	0.7
TNMM220408-MR	3	0.7	8	0.35	0.2	0.55
TNMM220408-PR	5	0.7	8	0.4	0.2	0.55
TNMM220412-MR	3	1	8	0.4	0.25	0.7
TNMM220412-PR	5	1	8	0.5	0.25	0.7
TNMM220416-MR	3	1.5	8	0.5	0.32	0.9
TNMM220416-PR	5	1.5	8	0.55	0.32	0.9
TNMX160404-WF	1	0.2	3	0.2	0.08	0.3
TNMX160408-WF	1.5	0.2	3	0.3	0.1	0.4
TNMX160408-WMX	3	0.5	5	0.45	0.15	0.7
TNMX160412-WM	2.5	0.5	5	0.4	0.15	0.6
TNMX160412-WMX	3.5	0.8	6	0.5	0.2	0.75
WNGA060404S01030A	0.1	0.07	0.4	0.1	0.05	0.2
WNGA060404S01030AWH	0.1	0.07	0.4	0.18	0.05	0.25
WNGA060404S01520HWH	0.1	0.07	0.2	0.18	0.05	0.25
WNGA060404S01525H	0.1	0.07	0.2	0.1	0.05	0.2
WNGA060404T01020B	0.1	0.07	0.4	0.1	0.05	0.2
WNGA060404T01020BWG	0.1	0.07	0.4	0.18	0.05	0.25
WNGA060404T01030AWH	0.1	0.07	0.4	0.18	0.05	0.25
WNGA060408S01030A	0.2	0.07	0.8	0.15	0.05	0.3
WNGA060408S01030AWH	0.1	0.05	0.3	0.28	0.05	0.35
WNGA060408S01520HWH	0.1	0.07	0.2	0.28	0.05	0.35
WNGA060408S01525H	0.2	0.07	0.4	0.15	0.05	0.3
WNGA060408T01020B	0.15	0.07	0.8	0.15	0.05	0.3
WNGA060408T01020BWG	0.1	0.07	0.8	0.28	0.05	0.35
WNGA060408T01030AWH	0.1	0.07	0.8	0.28	0.05	0.35
WNGA080404S01030A	0.1	0.05	0.4	0.1	0.05	0.2
WNGA080404S01030AWH	0.1	0.05	0.3	0.18	0.05	0.25
WNGA080404S01520HWH	0.1	0.07	0.2	0.18	0.05	0.25
WNGA080404S01525	0.1	0.1	0.5	0.1	0.05	0.2
WNGA080404S01525H	0.1	0.07	0.2	0.1	0.05	0.2
WNGA080404S01525WH	0.2	0.1	0.5	0.1	0.05	0.3
WNGA080404T01020B	0.1	0.07	0.4	0.1	0.05	0.2
WNGA080404T01020BWG	0.1	0.07	0.4	0.18	0.05	0.25
WNGA080404T01030AWH	0.1	0.07	0.4	0.18	0.05	0.25
WNGA080408S01030A	0.2	0.1	0.75	0.15	0.05	0.3
WNGA080408S01030AWH	0.1	0.05	0.5	0.28	0.05	0.35
WNGA080408S01520HWH	0.1	0.07	0.4	0.28	0.05	0.35
WNGA080408S01525	0.2	0.1	1	0.1	0.05	0.3
WNGA080408S01525H	0.2	0.07	0.4	0.15	0.05	0.3
WNGA080408S01525WH	0.2	0.1	1	0.15	0.05	0.35
WNGA080408S02035A	0.2	0.07	0.8	0.15	0.05	0.3
WNGA080408T01020B	0.15	0.07	0.8	0.15	0.05	0.3
WNGA080408T01020BWG	0.1	0.07	0.8	0.28	0.05	0.35
WNGA080408T01020W	3.6	0.1	6	0.25	0.15	0.36
WNGA080408T01030AWH	0.1	0.07	0.8	0.28	0.05	0.35

Avanço e profundidade de corte recomendados

Pastilha T-Max® P para torneamento

Pastilha	Profundidade de corte			Avanço de corte		
	Rec	a_p = mm Min.	Máx	Rec	f_n = mm/r Min.	Máx
WNGA080408T01525	0.2	0.1	1	0.1	0.05	0.3
WNGA080408T01525WH	0.2	0.1	1	0.15	0.05	0.35
WNGA080408T02520	3	0.1	5	0.2	0.15	0.36
WNGA080412S01030A	0.2	0.05	0.9	0.2	0.05	0.3
WNGA080412S01030AWH	0.2	0.05	0.5	0.32	0.05	0.4
WNGA080412S01520HWH	0.2	0.07	0.6	0.32	0.05	0.4
WNGA080412S01525H	0.2	0.07	0.6	0.2	0.05	0.3
WNGA080412T01020B	0.2	0.07	1.2	0.2	0.05	0.4
WNGA080412T01020WG	3.6	0.1	6	0.45	0.15	0.54
WNGA080412T01030AWH	0.2	0.07	1.2	0.32	0.05	0.4
WNGA080412T02520	3	0.1	5	0.3	0.15	0.54
WNGA080416T02520	3	0.1	5	0.4	0.15	0.6
VNGA160404S01020A	0.1	0.07	0.4	0.1	0.05	0.2
VNGA160404S01030A	0.1	0.07	0.4	0.2	0.05	0.3
VNGA160404S01525	0.1	0.1	0.5	0.1	0.05	0.2
VNGA160404S01525H	0.1	0.07	0.2	0.2	0.05	0.3
VNGA160408S01020A	0.1	0.07	0.8	0.15	0.05	0.3
VNGA160408S01030A	0.1	0.07	0.8	0.15	0.05	0.3
VNGA160408S01525	0.2	0.1	1	0.1	0.05	0.3
VNGA160408S01525H	0.1	0.07	0.4	0.15	0.05	0.3
VNGA160408S02035A	0.2	0.07	0.8	0.15	0.05	0.3
VNGA160408T01525	0.2	0.1	1	0.1	0.05	0.3
VNGA160412S01525	0.3	0.1	1.5	0.15	0.05	0.35
WNGG080401-SGF	0.1	0.05	3	0.03	0.01	0.08
WNGG080402-SGF	0.2	0.08	3	0.04	0.02	0.1
WNGG080404-SGF	0.3	0.1	3	0.12	0.05	0.25
WNGG080408-SGF	0.5	0.2	3	0.15	0.1	0.3
WNGG080412-SGF	0.8	0.3	3	0.18	0.1	0.3
VNGG160401-SGF	0.1	0.05	3	0.03	0.01	0.08
VNGG160402-SGF	0.2	0.08	3	0.04	0.02	0.1
VNGG160404-SGF	0.3	0.1	3	0.12	0.05	0.15
VNGG160408-SGF	0.5	0.2	3	0.15	0.07	0.2
VNGG160412-SGF	0.8	0.3	3	0.18	0.1	0.25
WNMA060408-KR	2.5	0.2	4	0.35	0.15	0.6
WNMA060412-KR	2.5	0.3	4	0.45	0.2	0.8
WNMA080408-KR	3	0.2	5	0.35	0.15	0.6
WNMA080412-KR	3	0.3	5	0.45	0.2	0.8
WNMA080416-KR	3	0.3	5	0.55	0.2	1
WNMG060404-KF	0.5	0.15	2	0.15	0.08	0.25
WNMG060404-MF	0.4	0.1	1.5	0.15	0.05	0.3
WNMG060404-PF	0.4	0.25	1.5	0.15	0.07	0.3
WNMG060404-SM	1	0.2	2.5	0.18	0.1	0.25
WNMG060404-WF	0.4	0.25	2	0.15	0.05	0.25
WNMG060404-XF	0.75	0.15	3	0.15	0.05	0.2
WNMG060408-KF	0.5	0.15	2	0.2	0.1	0.3
WNMG060408-KM	2	0.2	4	0.35	0.15	0.5
WNMG060408-KR	2.2	0.24	4.5	0.3	0.17	0.42
WNMG060408-MF	0.4	0.1	1.5	0.2	0.1	0.4
WNMG060408-MM	2	0.5	3	0.25	0.1	0.45
WNMG060408-MR	2	1.5	3	0.3	0.15	0.55
WNMG060408-PF	0.4	0.3	1.5	0.2	0.1	0.4
WNMG060408-PM	2	0.5	3	0.3	0.15	0.5
WNMG060408-PR	3	0.7	3.5	0.3	0.2	0.45
WNMG060408-QM	3	1	3	0.35	0.2	0.5
WNMG060408-SM	1.5	0.2	2.5	0.2	0.1	0.3
WNMG060408-WF	1	0.25	3	0.3	0.1	0.5
WNMG060408-WM	1.5	0.5	3.5	0.3	0.15	0.6
WNMG060408-WMX	3	0.5	5	0.45	0.15	0.7
WNMG060408-XF	1	0.2	3	0.2	0.05	0.25
WNMG060408-XM	2.5	0.5	4	0.25	0.1	0.35
WNMG060412-KM	2	0.3	4	0.4	0.15	0.6
WNMG060412-KR	2.2	0.32	4.5	0.4	0.2	0.56
WNMG060412-MM	2	0.5	3	0.3	0.1	0.6
WNMG060412-MR	2	1.5	3	0.35	0.15	0.6
WNMG060412-PF	0.8	0.4	1.5	0.25	0.15	0.5
WNMG060412-PM	2	0.8	3	0.35	0.18	0.6
WNMG060412-PR	3	0.8	3.5	0.35	0.25	0.55
WNMG060412-QM	3	1	3	0.35	0.25	0.6
WNMG060412-WM	1.5	0.8	3.5	0.5	0.2	0.9
WNMG060412-WMX	3.5	0.8	6	0.5	0.2	0.75
WNMG080404-KF	0.5	0.15	2	0.15	0.08	0.25
WNMG080404-MF	0.4	0.1	1.5	0.15	0.05	0.3
WNMG080404-PF	0.4	0.25	1.5	0.15	0.07	0.3

Pastilha	Profundidade de corte			Avanço de corte		
	Rec	a_p = mm Min.	Máx	Rec	f_n = mm/r Min.	Máx
WNMG080404-QM	3	1	4	0.2	0.18	0.25
WNMG080404-SF	0.4	0.15	1.5	0.12	0.08	0.22
WNMG080404-SM	1.5	0.15	2.5	0.2	0.1	0.3
WNMG080404-WF	0.4	0.25	3	0.15	0.05	0.25
WNMG080404-XF	0.75	0.15	4	0.15	0.05	0.2
WNMG080408-KF	0.5	0.15	2	0.2	0.1	0.3
WNMG080408-KM	2.5	0.2	5	0.35	0.15	0.5
WNMG080408-KR	2.7	0.29	5.5	0.34	0.17	0.47
WNMG080408-MF	0.4	0.1	1.5	0.2	0.1	0.4
WNMG080408-MM	2.5	0.5	4	0.25	0.1	0.45
WNMG080408-MR	2.5	2	4	0.3	0.15	0.55
WNMG080408-PF	0.4	0.3	1.5	0.2	0.1	0.4
WNMG080408-PM	2.5	0.5	4	0.3	0.15	0.5
WNMG080408-PR	4	0.7	5	0.35	0.2	0.55
WNMG080408-QM	3	1	4	0.35	0.2	0.5
WNMG080408-SF	0.5	0.2	1.5	0.15	0.1	0.25
WNMG080408-SM	2	0.2	3	0.25	0.1	0.35
WNMG080408-SMR	2	0.5	4	0.3	0.1	0.4
WNMG080408-WF	1	0.25	4	0.3	0.1	0.5
WNMG080408-WM	3	0.5	5	0.3	0.15	0.6
WNMG080408-WMX	3	0.5	5	0.45	0.15	0.7
WNMG080408-XF	1	0.2	4	0.2	0.05	0.25
WNMG080408-XM	2.5	0.5	5	0.25	0.1	0.4
WNMG080412-KF	1	0.2	2.5	0.25	0.1	0.35
WNMG080412-KM	2.5	0.3	5	0.4	0.15	0.6
WNMG080412-KR	2.7	0.39	5.5	0.45	0.23	0.63
WNMG080412-MM	2.5	0.5	4	0.3	0.1	0.6
WNMG080412-MF	2.5	2	4	0.35	0.15	0.6
WNMG080412-MR	0.8	0.4	1.5	0.25	0.15	0.5
WNMG080412-PM	2.5	0.8	4	0.35	0.18	0.6
WNMG080412-PR	4	1	5	0.4	0.25	0.7
WNMG080412-QM	3	1	4	0.35	0.25	0.55
WNMG080412-SM	2	0.3	3.5	0.28	0.12	0.38
WNMG080412-SMR	2	0.5	4	0.32	0.12	0.42
WNMG080412-WF	1.5	0.4	4	0.5	0.2	0.6
WNMG080412-WM	3.5	0.8	6	0.5	0.2	0.9
WNMG080412-WMX	3.5	0.8	6	0.5	0.2	0.75
WNMG080412-XM	3	0.7	5	0.3	0.15	0.45
WNMG080412-XMR	3	0.75	5	0.32	0.18	0.48
WNMG080416-KM	2.5	0.3	5	0.45	0.2	0.7
WNMG080416-PM	3	1	4	0.4	0.23	0.65
WNMG080416-PR	4	1.5	5	0.5	0.32	0.75
WNMG080416-QM	4	1.5	5	0.45	0.32	0.6
VNMG160404-MF	0.4	0.1	1.5	0.15	0.05	0.3
VNMG160404-PF	0.4	0.25	1.5	0.15	0.07	0.3
VNMG160404-QM	3	1	4	0.25	0.18	0.3
VNMG160404-SF	0.4	0.15	1.5	0.12	0.08	0.2
VNMG160404-SM	1	0.15	2	0.18	0.05	0.2
VNMG160408-KM	2	0.2	3.5	0.3	0.15	0.4
VNMG160408-MF	0.8	0.2	2.5	0.15	0.08	0.3
VNMG160408-MM	2	0.5	4	0.25	0.1	0.45
VNMG160408-PF	0.4	0.3	1.5	0.2	0.1	0.4
VNMG160408-PM	2	0.5	4	0.3	0.15	0.5
VNMG160408-QM	3	1	4	0.35	0.2	0.5
VNMG160408-SF	0.5	0.2	1.5	0.15	0.1	0.22
VNMG160408-SM	1.5	0.2	2.5	0.2	0.07	0.23
VNMG160412-KM	2	0.3	3.5	0.35	0.15	0.5
VNMG160412-PM	2	0.8	4	0.35	0.18	0.6
VNMG160412-QM	3	1	4	0.35	0.25	0.5
VNMG160412-SF	0.8	0.4	2	0.17	0.12	0.25
VNMG160412-SM	1.5	0.3	3	0.22	0.1	0.25
CNMG190616-XMR	4	1	8.5	0.5	0.25	0.8
SNMG120416-XMR	3.5	1	6	0.41	0.21	0.67

Avanço e profundidade de corte recomendados

Pastilha CoroTurn® 107 para torneamento

Pastilha	Profundidade de corte			Avanço de corte			Pastilha	Profundidade de corte			Avanço de corte		
	Rec	a_p = mm Mín. Máx		Rec	f_n = mm/r Mín. Máx			Rec	a_p = mm Mín. Máx		Rec	f_n = mm/r Mín. Máx	
CCET060201-UM	0.3	0.1	0.7	0.02	0.01	0.04	CCMT09T304-KF	0.35	0.11	2	0.11	0.06	0.23
CCET060202-UM	0.4	0.2	0.7	0.02	0.01	0.06	CCMT09T304-KM	0.64	0.25	3	0.15	0.08	0.23
CCET060204-UM	0.7	0.5	1	0.02	0.01	0.06	CCMT09T304-MF	0.35	0.11	2	0.11	0.06	0.23
CCGT060201-UM	0.3	0.1	0.7	0.02	0.01	0.06	CCMT09T304-MM	0.64	0.25	3	0.15	0.08	0.23
CCGT060202-UM	0.5	0.1	1.05	0.05	0.02	0.08	CCMT09T304-PF	0.35	0.11	2	0.11	0.06	0.23
CCGT060204-UM	1	0.5	1.4	0.14	0.08	0.21	CCMT09T304-PM	0.64	0.25	3	0.15	0.08	0.23
CCGT09T301-UM	0.3	0.1	0.7	0.02	0.01	0.06	CCMT09T304-UF	0.4	0.2	2	0.1	0.05	0.2
CCGT09T302-UM	0.5	0.1	1.05	0.05	0.02	0.08	CCMT09T304-UM	1.25	0.5	4	0.2	0.08	0.3
CCGT09T304-UM	1.25	0.5	2.1	0.11	0.08	0.18	CCMT09T304-UR	2	1	4	0.25	0.15	0.3
CCGT09T308-UM	1.25	0.5	2.1	0.14	0.12	0.25	CCMT09T304-WF	1	0.3	3	0.2	0.07	0.3
CCGW060202S01020F	0.07	0.04	0.1	0.07	0.03	0.1	CCMT09T304-WM	1.5	0.5	4	0.25	0.12	0.4
CCGW060202T01030F	0.07	0.04	0.2	0.07	0.03	0.1	CCMT09T308-KF	0.35	0.15	2	0.15	0.08	0.3
CCGW060204S01020F	0.1	0.07	0.2	0.1	0.05	0.2	CCMT09T308-KM	0.8	0.5	3	0.2	0.1	0.3
CCGW060204S01030F	0.1	0.07	0.4	0.1	0.05	0.2	CCMT09T308-KR	2	1	4	0.25	0.12	0.35
CCGW060204S01520FWH	0.1	0.07	0.2	0.18	0.05	0.25	CCMT09T308-MF	0.35	0.15	2	0.15	0.08	0.3
CCGW060204T01020F	0.1	0.07	0.4	0.1	0.05	0.2	CCMT09T308-MM	0.8	0.5	3	0.2	0.1	0.3
CCGW060204T01030F	0.1	0.05	0.4	0.1	0.05	0.2	CCMT09T308-MR	2	1	4	0.25	0.12	0.35
CCGW060204T01030FWH	0.1	0.07	0.4	0.18	0.05	0.25	CCMT09T308-PF	0.35	0.15	2	0.15	0.08	0.3
CCGW060208S01020F	0.2	0.07	0.4	0.15	0.05	0.3	CCMT09T308-PM	0.8	0.5	3	0.2	0.1	0.3
CCGW060208S01030F	0.2	0.07	0.8	0.15	0.05	0.3	CCMT09T308-PR	2	1	4	0.25	0.12	0.35
CCGW060208S01520FWH	0.2	0.07	0.4	0.28	0.05	0.35	CCMT09T308-UM	1.25	0.5	4	0.25	0.12	0.4
CCGW060208T01030F	0.2	0.07	0.8	0.15	0.05	0.3	CCMT09T308-UR	2	1	4	0.3	0.15	0.5
CCGW060208T01030FWH	0.2	0.07	0.8	0.28	0.05	0.35	CCMT09T308-WF	1	0.3	3	0.25	0.12	0.5
CCGW09T304S01020F	0.1	0.07	0.2	0.1	0.05	0.2	CCMT09T308-WM	1.5	0.7	4	0.3	0.15	0.5
CCGW09T304S01520FWH	0.1	0.07	0.2	0.18	0.05	0.25	CCMT09T312-KR	2	1.2	4	0.3	0.14	0.42
CCGW09T304S01530F	0.1	0.05	0.5	0.1	0.05	0.2	CCMT09T312-MM	2	1.2	4	0.3	0.14	0.42
CCGW09T304S01530FWH	0.1	0.05	0.3	0.18	0.05	0.25	CCMT09T312-PR	2	1.2	4	0.3	0.14	0.42
CCGW09T304S02030F	0.1	0.07	0.2	0.1	0.05	0.2	CCMT120404-KM	0.96	0.3	3.6	0.18	0.09	0.27
CCGW09T304T01020F	0.1	0.05	0.5	0.1	0.05	0.2	CCMT120404-MF	0.42	0.14	2.4	0.14	0.07	0.27
CCGW09T304T01020FWH	0.1	0.07	0.4	0.18	0.05	0.25	CCMT120404-MM	0.96	0.3	3.6	0.18	0.09	0.27
CCGW09T308S01020F	0.2	0.07	0.4	0.15	0.05	0.3	CCMT120404-PF	0.42	0.14	2.4	0.14	0.07	0.27
CCGW09T308S01520FWH	0.2	0.07	0.4	0.28	0.05	0.35	CCMT120404-PM	0.96	0.3	3.6	0.18	0.09	0.27
CCGW09T308S01530F	0.2	0.07	0.8	0.15	0.05	0.3	CCMT120404-WM	2	0.5	4	0.25	0.15	0.4
CCGW09T308S02030F	0.2	0.07	0.4	0.15	0.05	0.3	CCMT120408-KM	0.96	0.6	3.6	0.24	0.12	0.36
CCGW09T308T01020F	0.2	0.07	0.8	0.15	0.05	0.3	CCMT120408-KR	2.4	1.2	4.8	0.3	0.14	0.42
CCGW09T308T01020FWH	0.2	0.07	0.8	0.28	0.05	0.35	CCMT120408-MM	0.96	0.6	3.6	0.24	0.12	0.36
CCGW09T308T01020FWH	0.2	0.07	0.8	0.28	0.05	0.35	CCMT120408-MR	2.4	1.2	4.8	0.3	0.14	0.42
CCGW09T312S01020F	0.2	0.07	0.6	0.2	0.05	0.3	CCMT120408-PM	0.96	0.6	3.6	0.24	0.12	0.36
CCGW09T312S01520FWH	0.2	0.07	0.6	0.32	0.05	0.4	CCMT120408-PR	2.4	1.2	4.8	0.3	0.14	0.42
CCGX060202-AL	1	0.3	3	0.12	0.05	0.15	CCMT120408-UM	1.5	0.5	4	0.25	0.12	0.4
CCGX060204-AL	1	0.3	3	0.12	0.05	0.15	CCMT120408-UR	2.5	1	4	0.3	0.15	0.5
CCGX09T3L020-15FXA	0.12	0.05	0.2	0.3	0.2	0.4	CCMT120412-KR	2.4	1.44	4.8	0.36	0.17	0.5
CCGX09T304-AL	1.5	0.5	5	0.2	0.1	0.3	CCMT120412-MM	0.96	0.72	3.6	0.29	0.14	0.3
CCGX09T308-AL	1.5	0.5	5	0.3	0.15	0.6	CCMT120412-MR	2.4	1.44	4.8	0.36	0.17	0.5
CCGX120404-AL	1.5	0.5	7	0.2	0.1	0.3	CCMT120412-PM	0.96	0.72	3.6	0.29	0.14	0.43
CCGX120408-AL	1.5	0.5	7	0.3	0.15	0.6	CCMT120412-PR	2.4	1.44	4.8	0.36	0.17	0.5
CCMT060202-KF	0.3	0.06	1.7	0.06	0.03	0.11	CCMT160508-UR	3	1	5	0.35	0.15	0.5
CCMT060202-MF	0.3	0.06	1.7	0.06	0.03	0.11	CCMW060204FP	0.5	0.1	2.3	0.1	0.05	0.2
CCMT060202-PF	0.3	0.06	1.7	0.06	0.05	0.11	CCMW09T304FP	0.5	0.1	3.4	0.1	0.05	0.2
CCMT060202-UF	0.4	0.1	1.5	0.07	0.05	0.15	CCMW09T308FP	1	0.1	3.4	0.15	0.05	0.4
CCMT060202-WF	0.3	0.1	1.5	0.1	0.03	0.15	DCET070200-UM	0.3	0.1	4	0.03	0.01	0.06
CCMT060204-KF	0.3	0.1	1.7	0.08	0.05	0.17	DCET070201-UM	0.5	0.1	4	0.03	0.01	0.06
CCMT060204-KM	0.64	0.2	2.4	0.11	0.06	0.17	DCET11T301-UM	0.3	0.1	4	0.03	0.01	0.06
CCMT060204-MF	0.3	0.1	1.7	0.08	0.05	0.17	DCET11T302-UM	0.3	0.2	4	0.03	0.01	0.06
CCMT060204-MM	0.64	0.2	2.4	0.11	0.06	0.17	DCET11T304-UM	1.25	0.5	4	0.05	0.02	0.1
CCMT060204-PF	0.3	0.1	1.7	0.08	0.05	0.17	DCGT070201-UM	0.3	0.1	1	0.03	0.01	0.08
CCMT060204-PM	0.64	0.2	2.4	0.11	0.06	0.17	DCGT070202-UM	0.5	0.1	1.5	0.07	0.02	0.16
CCMT060204-UF	0.4	0.2	1.5	0.1	0.05	0.2	DCGT070204-UM	1	0.3	2.5	0.15	0.08	0.25
CCMT060204-UM	1	0.5	2.5	0.2	0.08	0.3	DCGT070208-UM	1	0.3	2.5	0.2	0.12	0.3
CCMT060204-UR	1.5	1	2.5	0.25	0.15	0.3	DCGT11T301-UM	0.3	0.1	1	0.03	0.01	0.06
CCMT060204-WF	0.8	0.3	2	0.12	0.05	0.3	DCGT11T302-UM	0.3	0.1	1.5	0.03	0.01	0.06
CCMT060208-KM	0.64	0.4	2.4	0.15	0.08	0.23	DCGT11T304-UM	1.25	0.3	3	0.15	0.08	0.25
CCMT060208-KR	1.6	0.8	3.2	0.19	0.09	0.26	DCGT11T308-UM	1.25	0.3	3	0.2	0.12	0.3
CCMT060208-MM	0.64	0.4	2.4	0.15	0.08	0.23	DCGW070202S01020F	0.07	0.04	0.1	0.07	0.03	0.1
CCMT060208-MR	1.6	0.8	3.2	0.19	0.09	0.26	DCGW070202T01030F	0.07	0.04	0.2	0.07	0.03	0.1
CCMT060208-PM	0.64	0.4	2.4	0.15	0.08	0.23	DCGW070204S01020F	0.1	0.07	0.2	0.1	0.05	0.2
CCMT060208-PR	1.6	0.8	3.2	0.19	0.09	0.26	DCGW070204S01030F	0.1	0.07	0.4	0.1	0.05	0.2
CCMT060208-UF	0.4	0.2	1.5	0.1	0.05	0.25	DCGW070204T01020F	0.1	0.07	0.4	0.1	0.05	0.2
CCMT060208-UM	1	0.5	2.5	0.25	0.12	0.4	DCGW070208S01030F	0.2	0.07	0.8	0.15	0.05	0.3
CCMT060208-WF	0.8	0.3	2	0.15	0.09	0.35	DCGW11T302T01020F	0.07	0.04	0.2	0.07	0.05	0.1
CCMT060208-WM	1.2	0.5	2.5	0.2	0.1	0.4	DCGW11T304S01020F	0.1	0.07	0.2	0.1	0.05	0.2
CCMT09T302-MF	0.35	0.08	2	0.08	0.04	0.15	DCGW11T304S01020FWH	0.1	0.05	0.4	0.15	0.05	0.25
CCMT09T302-PF	0.35	0.08	2	0.08	0.05	0.15	DCGW11T304S01520FWH	0.1	0.07	0.2	0.15	0.05	0.25
CCMT09T302-UF	0.4	0.1	2	0.07	0.05	0.15	DCGW11T304S01530F	0.1	0.07	0.4	0.1	0.05	0.2
CCMT09T302-WF	0.3	0.1	1.5	0.1	0.03	0.15							

Avanço e profundidade de corte recomendados

Pastilha CoroTurn® 107 para torneamento

Pastilha	Profundidade de corte			Avanço de corte		
	Rec	a_p = mm Mín. Máx		Rec	f_n = mm/r Mín. Máx	
DCGW11T304S02030F	0.1	0.07	0.2	0.1	0.05	0.2
DCGW11T304T01020F	0.1	0.07	0.4	0.1	0.05	0.2
DCGW11T308S01020F	0.2	0.07	0.4	0.15	0.05	0.3
DCGW11T308S01020FWH	0.2	0.07	0.8	0.2	0.05	0.3
DCGW11T308S01520FWH	0.2	0.07	0.4	0.2	0.05	0.3
DCGW11T308S01530F	0.2	0.07	0.8	0.15	0.05	0.3
DCGW11T308S02030F	0.2	0.07	0.4	0.15	0.05	0.3
DCGW11T308T01020F	0.2	0.07	0.8	0.15	0.05	0.3
DCGW11T312S01020F	0.2	0.07	0.6	0.2	0.05	0.3
DCGW11T312S01530F	0.2	0.07	1.2	0.15	0.05	0.3
DCGX070202-AL	1	0.3	4	0.12	0.05	0.15
DCGX070204-AL	1.5	0.5	4	0.2	0.1	0.3
DCGX11T302-AL	1	0.3	5.5	0.12	0.05	0.15
DCGX11T304-AL	1.5	0.5	5.5	0.2	0.1	0.3
DCGX11T308-AL	1.5	0.5	5.5	0.3	0.15	0.6
DCMT070202-KF	0.26	0.06	1.5	0.06	0.03	0.11
DCMT070202-MF	0.26	0.06	1.5	0.06	0.03	0.11
DCMT070202-PF	0.26	0.06	1.5	0.06	0.05	0.11
DCMT070202-UF	0.4	0.1	1.5	0.07	0.05	0.15
DCMT070204-KF	0.26	0.08	1.5	0.08	0.05	0.17
DCMT070204-KM	0.6	0.19	2.25	0.11	0.06	0.17
DCMT070204-MF	0.26	0.08	1.5	0.08	0.05	0.17
DCMT070204-MM	0.6	0.19	2.25	0.11	0.06	0.17
DCMT070204-PF	0.26	0.08	1.5	0.08	0.05	0.17
DCMT070204-PM	0.6	0.19	2.25	0.11	0.06	0.17
DCMT070204-UF	0.4	0.2	1.5	0.1	0.05	0.2
DCMT070204-UM	1	0.3	2.5	0.2	0.06	0.3
DCMT070204-UM	1	0.5	2.5	0.2	0.08	0.3
DCMT070208-KM	0.6	0.38	2.25	0.15	0.08	0.23
DCMT070208-MM	0.6	0.38	2.25	0.15	0.08	0.23
DCMT070208-PM	0.6	0.38	2.25	0.15	0.08	0.23
DCMT070208-UM	1	0.5	2.5	0.25	0.12	0.35
DCMT11T302-KF	0.35	0.08	2	0.08	0.04	0.15
DCMT11T302-MF	0.35	0.08	2	0.08	0.04	0.15
DCMT11T302-PF	0.35	0.08	2	0.08	0.05	0.15
DCMT11T304-KF	0.35	0.11	2	0.11	0.06	0.23
DCMT11T304-KM	0.8	0.25	3	0.15	0.08	0.23
DCMT11T304-MF	0.35	0.11	2	0.11	0.06	0.23
DCMT11T304-MM	0.8	0.25	3	0.15	0.08	0.23
DCMT11T304-PF	0.35	0.11	2	0.11	0.06	0.23
DCMT11T304-PM	0.8	0.25	3	0.15	0.08	0.23
DCMT11T304-UF	0.4	0.2	2	0.1	0.05	0.2
DCMT11T304-UM	1.25	0.5	4	0.2	0.08	0.3
DCMT11T304-UM	2	1	4	0.25	0.15	0.3
DCMT11T308-KF	0.35	0.15	2	0.15	0.08	0.3
DCMT11T308-KM	0.8	0.5	3	0.2	0.1	0.3
DCMT11T308-KR	2	1	4	0.25	0.12	0.35
DCMT11T308-MF	0.35	0.15	2	0.15	0.08	0.3
DCMT11T308-MM	0.8	0.5	3	0.2	0.1	0.3
DCMT11T308-MR	2	1	4	0.25	0.12	0.35
DCMT11T308-PF	0.35	0.15	2	0.15	0.08	0.3
DCMT11T308-PM	0.8	0.5	3	0.2	0.1	0.3
DCMT11T308-PR	2	1	4	0.25	0.12	0.35
DCMT11T308-UF	0.4	0.2	2	0.1	0.05	0.25
DCMT11T308-UM	1.25	0.5	4	0.25	0.12	0.4
DCMT11T308-UR	2	1	4	0.3	0.15	0.5
DCMT11T312-KM	0.8	0.6	3	0.24	0.12	0.36
DCMT11T312-KR	2	1.2	4	0.3	0.14	0.42
DCMT11T312-MM	0.8	0.6	3	0.24	0.12	0.36
DCMT11T312-MR	2	1.2	4	0.3	0.14	0.42
DCMT11T312-PM	0.8	0.6	3	0.24	0.12	0.36
DCMT11T312-PR	2	1.2	4	0.3	0.14	0.42
DCMT11T312-UR	2	1	4	0.3	0.2	0.5
DCMW11T304FP	0.5	0.1	3.3	0.1	0.05	0.2
DCMW11T308FP	1	0.1	3	0.15	0.05	0.4
DCMX070202-WF	0.3	0.1	1.5	0.1	0.03	0.15
DCMX070204-WF	0.7	0.3	2	0.12	0.05	0.25
DCMX070208-WF	0.7	0.3	2	0.15	0.09	0.35
DCMX11T302-WF	0.3	0.1	1.5	0.1	0.03	0.15
DCMX11T304-WF	1	0.3	3	0.2	0.07	0.3
DCMX11T304-WM	1.5	0.5	4	0.25	0.12	0.4
DCMX11T308-WF	1	0.3	3	0.25	0.12	0.4
DCMX11T308-WM	1.5	0.5	4	0.3	0.15	0.5

Pastilha	Profundidade de corte			Avanço de corte		
	Rec	a_p = mm Mín. Máx		Rec	f_n = mm/r Mín. Máx	
RCGX0602M0-AL	1	0.6	2.4	0.24	0.13	0.38
RCGX0803M0-AL	1.5	0.8	3.2	0.35	0.16	0.54
RCGX10T3M0-AL	2	1	4	0.36	0.16	0.63
RCGX1204M0-AL	2.5	1.2	4.8	0.46	0.19	0.79
RCMT0502M0	1	0.5	2	0.11	0.05	0.16
RCMT0602M0	1.5	0.5	2.4	0.15	0.05	0.17
RCMT060300	1.5	0.5	2.4	0.15	0.05	0.17
RCMT060300-SM	0.8	0.26	1.6	0.08	0.08	0.05
RCMT0803M0	2	0.8	3.2	0.2	0.05	0.25
RCMT0803M0-SM	1	0.33	2	0.08	0.08	0.06
RCMT09T300	2.5	1	4	0.25	0.06	0.32
RCMT09T300-M0	2.5	1	4	0.25	0.06	0.32
RCMT09T300-SM	1.5	0.4	2.5	0.1	0.09	0.08
RCMT10T3M0	2.5	1	4	0.25	0.06	0.32
RCMT10T3M0-SM	1.5	0.4	2.5	0.1	0.09	0.08
RCMT120400	3	1.2	4.8	0.3	0.08	0.38
RCMT120400	3	1.2	4.8	0.3	0.08	0.38
RCMT120400-M0	3	1.2	4.8	0.29	0.08	0.37
RCMT120400-SM	2	0.5	3	0.16	0.1	0.1
RCMT1204M0	3	1.2	4.8	0.3	0.08	0.38
RCMT1204M0-SM	2	0.5	3	0.12	0.1	0.1
RCMT1606M0	3.5	1.6	6.4	0.37	0.1	0.51
RCMT1606M0-SM	2.5	0.65	4	0.16	0.15	0.12
RCMT190600	4	2	8	0.45	0.13	0.63
RCMT2006M0	4	2	8	0.45	0.13	0.63
SCGW09T304S01030F	0.1	0.07	0.4	0.1	0.05	0.21
SCGW09T304T01020F	0.1	0.07	0.4	0.1	0.05	0.21
SCGW09T308S01030F	0.2	0.07	0.8	0.16	0.05	0.31
SCGW09T308S01530F	0.1	0.07	0.8	0.1	0.05	0.21
SCGW09T308T01020F	0.1	0.07	0.8	0.1	0.05	0.21
SCGX09T308-AL	1.5	0.5	5	0.31	0.16	0.62
SCMT09T304-KM	0.8	0.25	3	0.16	0.08	0.24
SCMT09T304-MF	0.35	0.11	2	0.11	0.06	0.24
SCMT09T304-MM	0.8	0.25	3	0.16	0.08	0.24
SCMT09T304-PF	0.35	0.11	2	0.11	0.06	0.24
SCMT09T304-PM	0.8	0.25	3	0.16	0.08	0.24
SCMT09T308-KM	0.8	0.5	3	0.21	0.1	0.31
SCMT09T308-KR	2	1	4	0.26	0.12	0.36
SCMT09T308-MF	0.35	0.15	2	0.16	0.08	0.31
SCMT09T308-MM	0.8	0.5	3	0.21	0.1	0.31
SCMT09T308-MR	2	1	4	0.26	0.12	0.36
SCMT09T308-PF	0.35	0.15	2	0.16	0.08	0.31
SCMT09T308-PM	0.8	0.5	3	0.21	0.1	0.31
SCMT09T308-PR	2	1	4	0.26	0.12	0.36
SCMT09T308-UF	0.4	0.2	2	0.1	0.05	0.26
SCMT09T308-UM	1.25	0.5	4	0.26	0.12	0.41
SCMT09T308-UR	2	1	4	0.31	0.16	0.52
SCMT09T312-KR	2	1.2	4	0.31	0.14	0.43
SCMT09T312-MR	2	1.2	4	0.31	0.14	0.43
SCMT09T312-PR	2	1.2	4	0.31	0.14	0.43
SCMT120404-MM	0.96	0.3	3.6	0.19	0.09	0.28
SCMT120404-PM	0.96	0.3	3.6	0.19	0.09	0.28
SCMT120404-UR	2.5	1	5	0.26	0.16	0.31
SCMT120408-KM	0.96	0.6	3.6	0.25	0.12	0.37
SCMT120408-KR	2.4	1.2	4.8	0.31	0.14	0.43
SCMT120408-MM	0.96	0.6	3.6	0.25	0.12	0.37
SCMT120408-MR	2.4	1.2	4.8	0.31	0.14	0.43
SCMT120408-PM	0.96	0.6	3.6	0.25	0.12	0.37
SCMT120408-PR	2.4	1.2	4.8	0.31	0.14	0.43
SCMT120408-UM	1.5	0.5	4	0.26	0.12	0.41
SCMT120408-UR	2.5	1	4	0.31	0.16	0.52
SCMT120412-KR	2.4	1.44	4.8	0.37	0.18	0.52
SCMT120412-MM	0.96	0.72	3.6	0.3	0.14	0.45
SCMT120412-MR	2.4	1.44	4.8	0.37	0.18	0.52
SCMT120412-PM	0.96	0.72	3.6	0.3	0.14	0.45
SCMT120412-PR	2.4	1.44	4.8	0.37	0.18	0.52
SCMT120412-UM	1.5	0.5	4	0.26	0.16	0.41
TCEX050100L-F	0.15	0.05	0.8	0.04	0.01	0.06
TCEX050100R-F	0.15	0.05	0.8	0.04	0.02	0.06
TCEX050101L-F	0.15	0.05	0.8	0.05	0.01	0.07
TCEX050101R-F	0.15	0.05	0.8	0.06	0.02	0.1
TCEX06T100L-F	0.2	0.05	1	0.05	0.01	0.07
TCEX06T100R-F	0.5	0.05	1.5	0.05	0.01	0.07

Avanço e profundidade de corte recomendados

Pastilha CoroTurn® 107 para torneamento

Pastilha	Profundidade de corte			Avanço de corte			Pastilha	Profundidade de corte			Avanço de corte		
	Rec	a_p = mm Mín. Máx		Rec	f_n = mm/r Mín. Máx			Rec	a_p = mm Mín. Máx		Rec	f_n = mm/r Mín. Máx	
TCEX06T101L-F	0.2	0.05	1	0.08	0.01	0.12	TCGX110308-AL	1.5	0.5	5	0.3	0.15	0.6
TCEX06T101R-F	0.08	0.05	1.5	0.08	0.01	0.12	TCGX16T304-AL	1.5	0.5	7	0.2	0.1	0.3
TCEX06T102L-F	0.2	0.05	1	0.08	0.02	0.15	TCGX16T308-AL	1.5	0.5	7	0.3	0.15	0.6
TCEX090200L-F	0.3	0.05	1.2	0.04	0.01	0.07	TCMT06T102-KF	0.26	0.06	1.5	0.06	0.05	0.11
TCEX090200R-F	0.4	0.05	1.4	0.06	0.01	0.08	TCMT06T102-KF	0.26	0.06	1.5	0.06	0.03	0.11
TCEX090201L-F	0.4	0.05	1.2	0.05	0.02	0.08	TCMT06T102-MF	0.26	0.06	1.5	0.06	0.03	0.11
TCEX090201R-F	0.6	0.05	2	0.07	0.02	0.1	TCMT06T102-PF	0.26	0.06	1.5	0.06	0.05	0.11
TCEX090202L-F	0.4	0.05	1.2	0.08	0.02	0.12	TCMT06T102-UF	0.4	0.2	1.5	0.07	0.05	0.15
TCEX110300L-F	0.5	0.05	1.5	0.05	0.01	0.08	TCMT06T104-KF	0.26	0.08	1.5	0.08	0.05	0.17
TCEX110300R-F	0.8	0.05	4	0.07	0.01	0.1	TCMT06T104-MF	0.26	0.08	1.5	0.08	0.05	0.17
TCEX110301L-F	0.6	0.05	1.7	0.06	0.02	0.1	TCMT06T104-PF	0.26	0.08	1.5	0.08	0.05	0.17
TCEX110301R-F	0.8	0.05	4	0.08	0.02	0.15	TCMT06T104-UF	0.4	0.2	1.5	0.1	0.05	0.2
TCEX110302L-F	0.7	0.05	2	0.08	0.02	0.12	TCMT06T108-KF	0.26	0.11	1.5	0.11	0.06	0.23
TCEX110302R-F	0.3	0.1	0.7	0.04	0.03	0.11	TCMT06T108-MF	0.26	0.11	1.5	0.11	0.06	0.23
TCEX110302L-K	0.3	0.1	1	0.05	0.03	0.15	TCMT06T108-PF	0.26	0.11	1.5	0.11	0.06	0.23
TCEX110302R-K	0.5	0.15	0.7	0.05	0.03	0.14	TCMT090202-KF	0.3	0.06	1.7	0.06	0.05	0.13
TCEX110302L-K	0.5	0.15	1	0.07	0.03	0.2	TCMT090202-MF	0.3	0.06	1.7	0.06	0.03	0.13
TCEX110302R-K	0.3	0.1	0.84	0.04	0.03	0.11	TCMT090202-PF	0.3	0.06	1.7	0.06	0.05	0.13
TCEX110302L-K	0.3	0.1	1.2	0.05	0.03	0.15	TCMT090204-KF	0.3	0.1	1.7	0.1	0.05	0.19
TCEX110302R-K	0.5	0.15	0.84	0.07	0.03	0.14	TCMT090204-MF	0.3	0.1	1.7	0.1	0.05	0.19
TCEX110302L-K	0.5	0.15	1.2	0.1	0.03	0.2	TCMT090204-PF	0.6	0.19	2.25	0.11	0.06	0.17
TCEX110302R-K	0.5	0.15	1.2	0.1	0.03	0.2	TCMT090204-KM	0.6	0.19	2.25	0.11	0.06	0.17
TCEX110302L-K	1	0.5	2.25	0.2	0.08	0.25	TCMT090204-MF	0.3	0.1	1.7	0.1	0.05	0.19
TCEX110302R-K	0.3	0.1	1	0.03	0.01	0.06	TCMT090204-MM	0.6	0.19	2.25	0.11	0.06	0.17
TCEX110302L-K	0.3	0.1	1.05	0.04	0.03	0.11	TCMT090204-PF	0.3	0.1	1.7	0.1	0.05	0.19
TCEX110302R-K	0.5	0.15	1.05	0.07	0.03	0.18	TCMT090204-PM	0.6	0.19	2.25	0.11	0.06	0.17
TCEX110302L-K	0.5	0.15	1.5	0.1	0.03	0.25	TCMT090204-UF	0.4	0.2	1.5	0.1	0.05	0.2
TCEX110302R-K	1.25	0.3	2.5	0.15	0.08	0.25	TCMT090204-UM	1	0.3	2.5	0.2	0.06	0.3
TCEX110302L-K	1.25	0.3	2.5	0.2	0.12	0.3	TCMT090204-UM	1	0.5	2.5	0.2	0.08	0.3
TCEX110302R-K	0.3	0.1	1	0.03	0.01	0.06	TCMT090208-KM	0.6	0.38	2.25	0.15	0.08	0.23
TCEX110302L-K	0.3	0.1	1.05	0.04	0.03	0.11	TCMT090208-MM	0.6	0.38	2.25	0.15	0.08	0.23
TCEX110302R-K	0.3	0.1	1.5	0.05	0.03	0.15	TCMT090208-PM	0.6	0.38	2.25	0.15	0.08	0.23
TCEX110302L-K	0.3	0.1	1.5	0.07	0.02	0.12	TCMT090208-UF	0.4	0.2	1.5	0.1	0.05	0.25
TCEX110302R-K	0.5	0.15	1.05	0.07	0.03	0.18	TCMT090208-UM	1	0.5	2.5	0.25	0.12	0.4
TCEX110302L-K	0.5	0.15	1.5	0.1	0.03	0.25	TCMT110202-UF	0.4	0.2	2	0.07	0.05	0.15
TCEX110302R-K	1.25	0.3	2.5	0.15	0.08	0.25	TCMT110204-UF	0.4	0.2	2	0.1	0.05	0.2
TCEX110302L-K	1.25	0.3	2.5	0.2	0.12	0.3	TCMT110204-UR	1.25	0.5	3	0.2	0.08	0.3
TCEX110302R-K	0.3	0.1	1	0.03	0.01	0.06	TCMT110204-UR	2	1	3	0.25	0.15	0.3
TCEX110302L-K	0.3	0.1	1.05	0.04	0.03	0.11	TCMT110208-UF	0.4	0.2	2	0.1	0.05	0.25
TCEX110302R-K	0.3	0.1	1.5	0.05	0.03	0.15	TCMT110208-UM	1.25	0.5	3	0.25	0.12	0.4
TCEX110302L-K	0.3	0.1	1.5	0.07	0.02	0.12	TCMT110208-UR	2	1	3	0.3	0.15	0.4
TCEX110302R-K	0.5	0.15	1.05	0.07	0.03	0.18	TCMT110302-KF	0.3	0.06	1.7	0.06	0.05	0.13
TCEX110302L-K	0.5	0.15	1.5	0.1	0.03	0.25	TCMT110302-MF	0.3	0.06	1.7	0.06	0.03	0.13
TCEX110302R-K	1.25	0.3	2.5	0.15	0.08	0.25	TCMT110302-PF	0.3	0.06	1.7	0.06	0.05	0.13
TCEX110302L-K	1.25	0.3	2.5	0.2	0.12	0.3	TCMT110304-KF	0.3	0.1	1.7	0.1	0.05	0.19
TCEX110302R-K	0.5	0.15	1.5	0.1	0.03	0.25	TCMT110304-KM	0.67	0.21	2.5	0.13	0.06	0.19
TCEX110302L-K	0.5	0.15	1.5	0.1	0.03	0.25	TCMT110304-MF	0.3	0.1	1.7	0.1	0.05	0.19
TCEX110302R-K	1.25	0.3	2.5	0.15	0.08	0.25	TCMT110304-KM	0.67	0.21	2.5	0.13	0.06	0.19
TCEX110302L-K	1.25	0.3	2.5	0.2	0.12	0.3	TCMT110304-MF	0.3	0.1	1.7	0.1	0.05	0.19
TCEX110302R-K	0.5	0.15	1.5	0.1	0.03	0.25	TCMT110304-PM	0.67	0.21	2.5	0.13	0.06	0.19
TCEX110302L-K	0.5	0.15	1.5	0.1	0.03	0.25	TCMT110304-PM	0.67	0.21	2.5	0.13	0.06	0.19
TCEX110302R-K	1.25	0.3	2.5	0.15	0.08	0.25	TCMT110308-KF	0.3	0.13	1.7	0.13	0.07	0.26
TCEX110302L-K	1.25	0.3	2.5	0.2	0.12	0.3	TCMT110308-KM	0.67	0.42	2.5	0.17	0.09	0.26
TCEX110302R-K	0.5	0.15	1.5	0.1	0.03	0.25	TCMT110308-KR	1.5	0.75	3	0.21	0.1	0.3
TCEX110302L-K	0.5	0.15	1.5	0.1	0.03	0.25	TCMT110308-KR	1.5	0.75	3	0.21	0.1	0.3
TCEX110302R-K	1.25	0.3	2.5	0.15	0.08	0.25	TCMT110308-MF	0.3	0.13	1.7	0.13	0.07	0.26
TCEX110302L-K	1.25	0.3	2.5	0.2	0.12	0.3	TCMT110308-MM	0.67	0.42	2.5	0.17	0.09	0.26
TCEX110302R-K	0.5	0.15	1.5	0.1	0.03	0.25	TCMT110308-MR	1.5	0.75	3	0.21	0.1	0.3
TCEX110302L-K	0.5	0.15	1.5	0.1	0.03	0.25	TCMT110308-PF	0.3	0.13	1.7	0.13	0.07	0.26
TCEX110302R-K	1.25	0.3	2.5	0.15	0.08	0.25	TCMT110308-PM	0.67	0.42	2.5	0.17	0.09	0.26
TCEX110302L-K	1.25	0.3	2.5	0.2	0.12	0.3	TCMT110308-PR	1.5	0.75	3	0.21	0.1	0.3
TCEX110302R-K	0.5	0.15	1.5	0.1	0.03	0.25	TCMT110312-KM	0.65	0.5	2.5	0.2	0.1	0.31
TCEX110302L-K	0.5	0.15	1.5	0.1	0.03	0.25	TCMT110312-KR	1.5	0.9	3	0.26	0.12	0.36
TCEX110302R-K	1.25	0.3	2.5	0.15	0.08	0.25	TCMT110312-PM	0.67	0.5	2.5	0.2	0.1	0.31
TCEX110302L-K	1.25	0.3	2.5	0.2	0.12	0.3	TCMT16T304-KF	0.35	0.11	2	0.11	0.06	0.23
TCEX110302R-K	0.5	0.15	1.5	0.1	0.03	0.25	TCMT16T304-KM	0.8	0.25	3	0.15	0.08	0.23
TCEX110302L-K	0.5	0.15	1.5	0.1	0.03	0.25	TCMT16T304-MF	0.35	0.11	2	0.11	0.06	0.23
TCEX110302R-K	1.25	0.3	2.5	0.15	0.08	0.25	TCMT16T304-MM	0.8	0.25	3	0.15	0.08	0.23
TCEX110302L-K	1.25	0.3	2.5	0.2	0.12	0.3	TCMT16T304-PF	0.35	0.11	2	0.11	0.06	0.23
TCEX110302R-K	0.5	0.15	1.5	0.1	0.03	0.25	TCMT16T304-PM	0.8	0.25	3	0.15	0.08	0.23
TCEX110302L-K	0.5	0.15	1.5	0.1	0.03	0.25	TCMT16T304-UM	1.5	0.5	4	0.2	0.08	0.3
TCEX110302R-K	1.25	0.3	2.5	0.15	0.08	0.25	TCMT16T304-UR	2.5	1	4	0.25	0.15	0.3
TCEX110302L-K	1.25	0.3	2.5	0.2	0.12	0.3	TCMT16T308-KM	0.8	0.5	3	0.2	0.1	0.3
TCEX110302R-K	0.5	0.15	1.5	0.1	0.03	0.25	TCMT16T308-KR	2	1	4	0.25	0.12	0.35
TCEX110302L-K	0.5	0.15	1.5	0.1	0.03	0.25	TCMT16T308-MM	0.8	0.5	3	0.2	0.1	0.3
TCEX110302R-K	1.25	0.3	2.5	0.15	0.08	0.25							

A

Avanço e profundidade de corte recomendados

Pastilha CoroTurn® 107 para torneamento

Pastilha	Profundidade de corte			Avanço de corte		
	Rec	$a_p = \text{mm}$		Rec	$f_n = \text{mm/r}$	
		Mín.	Máx.		Mín.	Máx.
TCMT16T308-MR	2	1	4	0.25	0.12	0.35
TCMT16T308-PM	0.8	0.5	3	0.2	0.1	0.3
TCMT16T308-PR	2	1	4	0.25	0.12	0.35
TCMT16T308-UF	0.4	0.2	2	0.1	0.05	0.25
TCMT16T308-UM	1.5	0.5	4	0.25	0.12	0.4
TCMT16T308-UR	2.5	1	4	0.3	0.15	0.5
TCMT16T312-KM	0.8	0.6	3	0.24	0.12	0.36
TCMT16T312-KR	2	1.2	4	0.3	0.14	0.42
TCMT16T312-MM	0.8	0.6	3	0.24	0.12	0.36
TCMT16T312-MR	2	1.2	4	0.3	0.14	0.42
TCMT16T312-PM	0.8	0.6	3	0.24	0.12	0.36
TCMT16T312-PR	2	1.2	4	0.3	0.14	0.42
TCMT16T312-UR	2.5	1	4	0.3	0.2	0.5
TCMT220408-KM	0.96	0.6	3.6	0.24	0.12	0.36
TCMT220408-KR	2.4	1.2	4.8	0.3	0.14	0.42
TCMT220408-MM	0.96	0.6	3.6	0.24	0.12	0.36
TCMT220408-MR	2.4	1.2	4.8	0.3	0.14	0.42
TCMT220408-PM	0.96	0.6	3.6	0.24	0.12	0.36
TCMT220408-PR	2.4	1.2	4.8	0.3	0.14	0.42
TCMT220412-KR	2.4	1.44	4.8	0.36	0.17	0.5
TCMT220412-MR	2.4	1.44	4.8	0.36	0.17	0.5
TCMT220412-PR	2.4	1.44	4.8	0.36	0.17	0.5
TCMW090204FP	0.5	0.1	2.2	0.1	0.05	0.2
TCMW110204FP	0.5	0.1	2.2	0.1	0.05	0.2
TCMW110208FP	1	0.1	1.9	0.15	0.05	0.4
TCMW110304FP	0.5	0.1	2.2	0.1	0.05	0.2
TCMW110308FP	1	0.1	1.9	0.15	0.05	0.4
TCMW16T304FLP	0.5	0.1	7	0.1	0.05	0.2
TCMW16T304FP	0.5	0.1	3.4	0.1	0.05	0.2
TCMW16T304FRP	0.5	0.1	7	0.1	0.05	0.2
TCMW16T308FP	1	0.1	3.1	0.15	0.05	0.4
TCMX090202-WF	0.3	0.1	1.5	0.1	0.03	0.15
TCMX090204-WF	0.7	0.3	2	0.12	0.05	0.3
TCMX090208-WF	0.7	0.3	2	0.25	0.1	0.35
TCMX110302-WF	0.3	0.1	1.5	0.1	0.03	0.15
TCMX110304-WF	1	0.3	2.5	0.2	0.07	0.3
TCMX110308-WF	1	0.3	2.5	0.25	0.12	0.4
TCMX110308-WM	1.2	0.5	3	0.3	0.15	0.5
TCMX16T304-WF	1.2	0.3	3.5	0.2	0.07	0.35
TCMX16T308-WF	1.2	0.3	3.5	0.25	0.12	0.5
TCMX16T308-WM	1.5	0.5	4	0.3	0.15	0.5
VBGT160401-UM	0.3	0.1	1	0.03	0.01	0.08
VBGT160402-UM	0.5	0.1	1.5	0.07	0.02	0.16
VBGT160404-UM	1.25	0.3	4	0.2	0.08	0.3
VBGT160408-UM	1.25	0.3	4	0.25	0.12	0.3
VBGW110302S01020F	0.07	0.04	0.1	0.07	0.03	0.1
VBGW110302T01020F	0.07	0.04	0.2	0.07	0.03	0.1
VBGW110304S01020F	0.1	0.07	0.2	0.1	0.05	0.2
VBGW160404S01020F	0.1	0.07	0.2	0.1	0.05	0.2
VBGW160404S01030F	0.1	0.07	0.4	0.1	0.05	0.2
VBGW160404S01530F	0.1	0.07	0.4	0.1	0.05	0.2
VBGW160404T01020F	0.1	0.07	0.4	0.1	0.05	0.2
VBGW160408S01020F	0.2	0.07	0.4	0.15	0.05	0.3
VBGW160408S01530F	0.2	0.07	0.8	0.15	0.05	0.3
VBGW160408T01020F	0.2	0.07	0.8	0.15	0.05	0.3
VBMT110202-UF	0.4	0.2	1.5	0.07	0.05	0.15
VBMT110204-UF	0.4	0.2	1.5	0.1	0.05	0.2
VBMT110208-UF	0.4	0.2	1.5	0.1	0.05	0.25
VBMT110302-KF	0.3	0.06	1.7	0.06	0.03	0.13
VBMT110302-MF	0.3	0.06	1.7	0.06	0.03	0.13
VBMT110302-PF	0.3	0.06	1.7	0.06	0.05	0.13
VBMT110304-KF	0.3	0.1	1.7	0.1	0.05	0.19
VBMT110304-MF	0.3	0.1	1.7	0.1	0.05	0.19
VBMT110304-PF	0.3	0.1	1.7	0.1	0.05	0.19
VBMT110308-KF	0.3	0.13	1.7	0.13	0.07	0.26
VBMT110308-MF	0.3	0.13	1.7	0.13	0.07	0.26
VBMT110308-PF	0.3	0.13	1.7	0.13	0.07	0.26
VBMT110312-PF	0.3	0.13	1.7	0.15	0.08	0.31
VBMT160402-KF	0.32	0.07	1.8	0.07	0.04	0.14
VBMT160402-MF	0.32	0.07	1.8	0.07	0.04	0.14
VBMT160402-PF	0.32	0.07	1.8	0.07	0.05	0.14
VBMT160404-KF	0.32	0.1	1.8	0.1	0.05	0.2
VBMT160404-KM	0.72	0.23	2.7	0.14	0.07	0.2

Pastilha	Profundidade de corte			Avanço de corte		
	Rec	$a_p = \text{mm}$		Rec	$f_n = \text{mm/r}$	
		Mín.	Máx.		Mín.	Máx.
VBMT160404-MF	0.32	0.1	1.8	0.1	0.05	0.2
VBMT160404-MM	0.72	0.23	2.7	0.14	0.07	0.2
VBMT160404-PF	0.32	0.1	1.8	0.1	0.05	0.2
VBMT160404-PM	0.72	0.23	2.7	0.14	0.07	0.2
VBMT160404-UM	1.25	0.5	4	0.2	0.08	0.3
VBMT160404-UR	2	1	4	0.25	0.15	0.3
VBMT160408-KF	0.32	0.14	1.8	0.14	0.07	0.27
VBMT160408-KM	0.72	0.45	2.7	0.18	0.09	0.27
VBMT160408-KR	1.8	0.9	3.6	0.23	0.11	0.32
VBMT160408-MF	0.32	0.14	1.8	0.14	0.07	0.27
VBMT160408-MM	0.72	0.45	2.7	0.18	0.09	0.27
VBMT160408-MR	1.8	0.9	3.6	0.23	0.11	0.32
VBMT160408-PF	0.32	0.14	1.8	0.14	0.07	0.27
VBMT160408-PM	0.72	0.45	2.7	0.18	0.09	0.27
VBMT160408-PR	1.8	0.9	3.6	0.23	0.11	0.32
VBMT160408-UM	1.25	0.5	4	0.25	0.12	0.4
VBMT160408-UR	2	1	4	0.3	0.15	0.5
VBMT160412-KM	0.72	0.54	2.7	0.22	0.11	0.32
VBMT160412-KR	1.8	1.08	3.6	0.27	0.13	0.38
VBMT160412-MF	0.32	0.14	1.8	0.16	0.09	0.32
VBMT160412-MM	0.72	0.54	2.7	0.22	0.11	0.32
VBMT160412-MR	1.8	1.08	3.6	0.27	0.13	0.38
VBMT160412-PF	0.32	0.14	1.8	0.16	0.09	0.32
VBMT160412-PM	0.72	0.54	2.7	0.22	0.11	0.32
VBMT160412-PR	1.8	1.08	3.6	0.27	0.13	0.38
VBMT160412-UM	1.25	0.5	4	0.25	0.1	0.4
VBMT160412-UR	2	1	4	0.3	0.2	0.5
VCET110301-UM	0.3	0.1	4	0.03	0.01	0.06
VCET110302-UM	0.5	0.2	4	0.03	0.02	0.08
VCEX110300L-F	1	0.03	3	0.05	0.01	0.14
VCEX110300R-F	1	0.03	4	0.05	0.01	0.2
VCEX110301L-F	1	0.05	3	0.07	0.01	0.21
VCEX110301R-F	1	0.05	4	0.1	0.01	0.3
VCGT110301-UM	0.3	0.1	1	0.03	0.01	0.08
VCGT110302-UM	0.5	0.1	1.5	0.07	0.02	0.16
VCGT110304-UM	1.25	0.3	3	0.15	0.08	0.25
VCGX110202-AL	1	0.3	3	0.12	0.05	0.15
VCGX110204-AL	1.5	0.5	3	0.2	0.1	0.3
VCGX110302-AL	1	0.3	3	0.12	0.05	0.15
VCGX110304-AL	1.5	0.5	3	0.2	0.1	0.3
VCGX160404-AL	1.5	0.5	5	0.2	0.1	0.3
VCGX160408-AL	1.5	0.5	5	0.3	0.15	0.6
VCGX160412-AL	1.5	0.5	5	0.4	0.15	0.8
VCGX220520-AL	1.5	0.5	7	0.6	0.25	1
VCGX220530-AL	1.5	0.5	7	0.6	0.25	1
VCMT110302-PF	0.3	0.07	1.5	0.07	0.05	0.13
VCMT110304-KF	0.3	0.1	1.5	0.1	0.05	0.2
VCMT110304-MF	0.3	0.1	1.5	0.1	0.05	0.2
VCMT110304-MM	0.77	0.31	2.55	0.15	0.1	0.25
VCMT110304-PF	0.3	0.1	1.5	0.1	0.05	0.2
VCMT110304-PM	0.77	0.31	2.55	0.15	0.1	0.25
VCMT110308-KM	0.77	0.61	2.55	0.2	0.13	0.33
VCMT110308-MM	0.77	0.61	2.55	0.2	0.13	0.33
VCMT110308-PM	0.77	0.61	2.55	0.2	0.13	0.33
VCMW110204FP	0.5	0.1	3.5	0.1	0.05	0.2
VCMW110304FP	0.5	0.1	3.5	0.1	0.05	0.2
VCMW160408FP	1	0.1	2.8	0.15	0.05	0.4
VCMW160412FP	1	0.1	2.1	0.15	0.05	0.4

Avanço e profundidade de corte recomendados

Pastilha T-Max® para torneamento

Pastilha	Profundidade de corte			Avanço de corte		
	Rec	$a_p = \text{mm}$ Mín. Máx		Rec	$f_n = \text{mm/r}$ Mín. Máx	
CNGN120708T02520	2	1	3	0.2	0.15	0.5
CNGN160716T01020	2	1	3	0.19	0.07	0.3
CNGN120408T01020	1.2	0.1	3.6	0.1	0.07	0.2
CNGN120412S02520M	2	0.5	4	0.35	0.1	0.6
CNGN120412T01020	1.2	0.1	3.6	0.14	0.07	0.3
CNGN120412T02520	2	1	3	0.2	0.1	0.5
CNGN120416S02520M	2	0.5	4	0.35	0.1	0.6
CNGN120416T01020	1.2	0.1	3.6	0.19	0.07	0.3
CNGN120708T01020	1.2	0.1	3.6	0.1	0.07	0.2
CNGN120712T01020	1.2	0.1	3.6	0.14	0.07	0.2
CNGN120716T01020	1.2	0.1	3.6	0.19	0.07	0.3
CNGN120716T02520	2	1	3	0.2	0.15	0.5
CNGN160708T01020	1.6	0.1	4.8	0.1	0.07	0.2
CNGN160712T01020	1.6	0.1	4.8	0.14	0.07	0.3
DNGN150408T01020	1.5	0.1	4.5	0.1	0.07	0.2
DNGN150412T01020	1.5	0.1	4.5	0.14	0.07	0.3
DNGN150708T01020	1.5	0.1	4.5	0.1	0.07	0.2
DNGN150712T01020	1.5	0.1	4.5	0.14	0.07	0.3
DNGN150712T02520	2	1	3	0.2	0.1	0.5
DNGN150716K07015	4.5	0.1	7.5	0.4	0.05	0.6
DNGN150716T01020	1.5	0.1	4.5	0.19	0.07	0.3
DNGN150716T07015	4.5	0.1	7.5	0.4	0.05	0.6
RCGX060600E	0.8	0.4	1.6	0.03	0.03	0.03
RCGX060600T01020	0.9	0.1	1.8	0.12	0.1	0.2
RCGX090700E	1.2	0.6	2.4	0.05	0.05	0.05
RCGX090700T01020	1.35	0.1	2.7	0.15	0.1	0.2
RCGX090700T07015	2.7	0.1	3.6	0.25	0.1	0.6
RCGX120700E	1.8	0.9	3.6	0.08	0.08	0.08
RCGX120700K15015	3.6	0.1	4.8	0.3	0.1	0.6
RCGX120700T01020	1.8	0.1	3.6	0.15	0.1	0.2
RCGX120700T02520	2	1	3	0.4	0.3	0.5
RCGX120700T15015	2	1	3	0.4	0.3	0.5
RCGX151000T20015	4.5	0.1	6	0.3	0.1	0.6
RCGX191000K20015	5.7	0.1	7.6	0.4	0.1	0.6
RCGX191000T20015	5.7	0.1	7.6	0.4	0.1	0.6
RNGN060300S02520M	2	0.5	4	0.49	0.14	0.85
RNGN090300S02520M	2	0.5	4	0.49	0.14	0.85
RNGN090300T01020	1.35	0.1	2.7	0.15	0.1	0.25
RNGN120300S02520M	2	0.5	4	0.49	0.14	0.85
RNGN120400E	1.8	0.9	3.6	0.08	0.08	0.08
RNGN120400S02520M	2	0.5	4	0.49	0.14	0.85
RNGN120400T01020	1.8	0.1	3.6	0.15	0.1	0.3
RNGN120400T02520	2	1	3	0.2	0.15	0.5
RNGN120700E	1.8	0.9	3.6	0.08	0.08	0.08
RNGN120700K15015	3.6	0.1	4.8	0.3	0.1	0.6
RNGN120700T01020	1.8	0.1	3.6	0.15	0.1	0.2
RNGN120700T02520	2	1	3	0.2	0.1	0.5
RNGN120700T15015	3.6	0.1	4.8	0.3	0.1	0.6
RNGN150700T01020	2.25	0.1	4.5	0.2	0.1	0.3
RNGN150700T20015	2.25	0.1	4.5	0.2	0.1	0.3
RNGN190700E	2.4	1.2	4.8	0.11	0.11	0.11
RNGN190700K20015	2.85	0.1	5.7	0.2	0.1	0.4
RNGN190700T01020	2.85	0.1	5.7	0.2	0.1	0.4
RNGN190700T20015	5.7	0.1	7.6	0.4	0.1	0.6
RPGN060300E	0.9	0.4	1.8	0.12	0.1	0.2
RPGN060300T01020	0.9	0.4	1.8	0.12	0.1	0.2
RPGN090300E	1.35	0.6	2.7	0.15	0.1	0.2
RPGN090300T01020	1.35	0.1	2.7	0.15	0.1	0.25
RPGN120400E	1.8	0.9	3.6	0.15	0.1	0.2
RPGN120400T01020	1.8	0.9	3.6	0.15	0.1	0.25
RPGX060600T01020	1.8	0.4	3.6	0.12	0.1	0.2
RPGX090700E	1.2	0.6	2.4	0.05	0.05	0.05
RPGX090700T01020	1.35	0.1	2.7	0.15	0.1	0.2
RPGX120700E	1.8	0.9	3.6	0.08	0.08	0.08
RPGX120700T01020	1.8	0.1	3.6	0.15	0.1	0.2
SNGN120416T01020	1.2	0.1	3.6	0.2	0.07	0.31
SNGN090308T01020	0.9	0.1	2.7	0.1	0.07	0.21
SNGN090312S02520M	2	0.5	4	0.36	0.1	0.62
SNGN090312T01020	0.9	0.1	2.7	0.14	0.07	0.31
SNGN120408T01020	1.2	0.1	3.6	0.1	0.07	0.21
SNGN120408T02520	2	1	3	0.21	0.16	0.52
SNGN120412E	2	1	4	0.16	0.1	0.21
SNGN120412S02520M	2	0.5	4	0.36	0.1	0.62

Pastilha	Profundidade de corte			Avanço de corte		
	Rec	$a_p = \text{mm}$ Mín. Máx		Rec	$f_n = \text{mm/r}$ Mín. Máx	
SNGN120412T01020	1.2	0.1	3.6	0.14	0.07	0.31
SNGN120412T02520	2	1	3	0.21	0.1	0.52
SNGN120416S02520M	2	0.5	4	0.36	0.1	0.62
SNGN120416T02520	2	1	3	0.21	0.16	0.52
SNGN120708T01020	1.2	0.1	3.6	0.1	0.07	0.21
SNGN120708T02520	2	1	3	0.21	0.16	0.52
SNGN120712E	2	1	4	0.16	0.1	0.21
SNGN120712T01020	1.2	0.1	3.6	0.14	0.07	0.21
SNGN120712T02520	2	1	3	0.21	0.1	0.52
SNGN120716K15015	3.6	0.1	6	0.41	0.05	0.62
SNGN120716T01020	1.2	0.1	3.6	0.2	0.07	0.31
SNGN120716T02520	2	1	3	0.21	0.16	0.52
SNGN120716T15015	3.6	0.1	6	0.41	0.05	0.62
SNGN150708T01020	1.5	0.1	4.5	0.1	0.07	0.21
SNGN150716T01020	1.5	0.1	4.5	0.2	0.07	0.31
SNGN150716T02520	2	1	3	0.21	0.16	0.52
SNGN190716T01020	1.9	0.1	5.7	0.2	0.07	0.31
SNGN190724E	4	2	6	0.16	0.1	0.21
SNGN190724T01020	1.9	0.1	5.7	0.2	0.07	0.31
SPGN120408T01020	1.2	0.1	3.6	0.1	0.07	0.21
SPGN120412T01020	1.2	0.1	3.6	0.14	0.07	0.31
SPUN120304FP	0.5	0.1	3.7	0.1	0.05	0.21
TNGN110308T01020	1.1	0.1	3.3	0.1	0.07	0.2
TNGN160408T01020	1.6	0.1	4.8	0.1	0.07	0.2
TNGN160412T01020	1.6	0.1	4.8	0.14	0.07	0.3
TNGN160416T01020	1.6	0.1	4.8	0.19	0.07	0.3
TNGN160708T01020	1.6	0.1	4.8	0.1	0.07	0.2
TNGN160712T01020	1.6	0.1	4.8	0.14	0.07	0.3
TPGN110304T01020	1.1	0.1	3.3	0.09	0.07	0.1
TPGN110308T01020	1.1	0.1	3.3	0.1	0.07	0.2
TPGN160304T01020	1.6	0.1	4.8	0.09	0.07	0.1
TPGN160308E	4.8	0.1	8	0.2	0.05	0.36
TPGN160308T01020	1.6	0.1	4.8	0.1	0.07	0.2
TPGN160312T01020	1.6	0.1	4.8	0.14	0.07	0.3
TPUN110304FP	0.5	0.1	2.2	0.1	0.05	0.2
TPUN160304FLP	0.5	0.1	7	0.1	0.05	0.2
TPUN160304FRP	0.5	0.1	2.2	0.1	0.05	0.2

Pastilha CoroTurn® 300 para torneamento

3-80-101104-8-L4	1.2	0.25	3	0.2	0.1	0.3
3-80-101108-8-L4	1.6	0.5	3	0.22	0.12	0.32
3-80-101108-8-M5	2.5	0.8	3.8	0.32	0.2	0.45
3-80-101108-8-M5W	2.5	0.5	3.8	0.45	0.2	0.6
3-80-101112-8-L4	2	0.65	3	0.25	0.15	0.35
3-80-101112-8-M5	3	1.2	3.8	0.35	0.25	0.55
3-80-101112-8-M5W	3	0.8	3.8	0.5	0.25	0.7

Pastilha CoroTurn® Prime para torneamento

CP-A1104-L5	1	0.25	3	0.4	0.2	0.5
CP-A1108-L5	1	0.25	3	0.4	0.2	0.5
CP-A1108-L5W	1	0.25	3	0.4	0.2	0.5
CP-B1108-M5	2	0.5	4	0.59	0.31	1.21
CP-B1108-M5W	2	0.5	4	0.59	0.31	1.21

Pastilha CoroTurn® TR para torneamento

TR-DC1304-F	1	0.15	3	0.2	0.08	0.3
TR-DC1304S01020F	0.2	0.07	0.6	0.2	0.05	0.3
TR-DC1308-F	1	0.15	3	0.24	0.1	0.4
TR-DC1308-M	2	0.5	5	0.25	0.1	0.4
TR-DC1308S01020F	0.2	0.07	0.6	0.2	0.05	0.3
TR-DC1312-M	2	0.5	5	0.3	0.15	0.5
TR-VB1302-F	0.3	0.05	1	0.07	0.03	0.13
TR-VB1304-F	0.8	0.1	2	0.15	0.06	0.35
TR-VB1304S01020F	0.1	0.07	0.2	0.1	0.05	0.2
TR-VB1308-F	0.8	0.1	2	0.2	0.09	0.4
TR-VB1308S01020F	0.1	0.07	0.2	0.1	0.05	0.2
TR-VB1312-F	0.8	0.1	2	0.2	0.09	0.4

Classes para torneamento geral



Aços, ferros fundidos, aços inoxidáveis martensíticos, ferros maleáveis com cavacos longos

B

Classes básicas



GC4305 (HC) - P05 (P01-P15)

Uma classe com cobertura CVD recomendada para condições estáveis quando for necessária alta taxa de remoção de metal em aplicações de desbaste de aços. É resistente a alta temperaturas.

Classes complementares



GC1525 (HC) – P15 (P05-P25)

Uma classe de cermet com cobertura PVD para acabamento e semiacabamento de aços com baixo teor de carbono e baixa-liga. Deve ser usada quando for necessário um bom acabamento superficial em velocidades de corte médias a altas. $f_n \times a_p < 0,35 \text{ mm}^2$.

C



GC4315 (HC) - P15 (P01-P30)

Uma classe de metal duro com cobertura CVD para acabamento a desgaste em aplicações com corte contínuo a levemente interrompidos de aços e aços fundidos.



CT5015 (HT) – P10 (P01-P20)

Uma classe de cermet sem cobertura para acabamento quando for necessário um bom acabamento superficial. $f_n \times a_p < 0,35 \text{ mm}^2$

D



GC4325 (HC) - P25 (P10-P40)

Uma classe de metal duro com cobertura CVD para acabamento a desbaste de aços e aços fundidos. Essa classe pode lidar com cortes contínuos e cortes interrompidos com altas taxas de remoção de metal. Uma classe para uma ampla área de aplicação.

E



GC4335 (HC) - P35 (P25-P45)

Uma classe com cobertura CVD para torneamento de aços com desempenho seguro e confiável em operações difíceis e exigentes. Ideal para superfícies difíceis, problemas com vibração, interrupções pesadas e condições instáveis.

F

G

Letras-símbolo especificando a designação de materiais de corte duros:

Metais duros:

HW Metal duro sem cobertura contendo principalmente carboneto de tungstênio (WC)

HT Metal duro sem cobertura, também chamado cermet, contendo principalmente carbonetos de titânio (TiC) ou nitretos de titânio (TiN) ou ambos.

HC Metais duros como acima, porém com cobertura

Cerâmicas:

CA Cerâmicas à base de óxido contendo principalmente óxido de alumínio (Al_2O_3).

CM Cerâmicas mistas contendo principalmente óxido de alumínio (Al_2O_3) e outros elementos além de óxidos.

CN Cerâmicas à base de nitreto, principalmente nitreto de silício (Si_3N_4).

CC Cerâmicas como acima, porém com cobertura.

Diamante:

DP Diamante policristalino¹⁾

Nitreto de boro:

BN Nitreto de boro policristalino¹⁾

¹⁾ Diamante policristalino e nitreto de boro policristalino são também denominados materiais de corte superduros.

Classes para torneamento geral

M Aços inoxidáveis austeníticos, aços fundidos, aços manganês, ligas de ferro fundido, ferros maleáveis, aços de corte livre.

Classes básicas



GC2015 (HC) – M15 (M05-M25)

Uma classe de metal duro com cobertura CVD para acabamento e desbaste leve. Uma escolha para cortes contínuos em velocidades de corte moderadas a altas.



GC2025 (HC) – M25 (M15-M35)

Uma classe de metal duro com cobertura CVD otimizada para semiacabamento a desbaste. A classe trabalha bem em cortes interrompidos.



GC2220 (HC) - M20 (M15-M30)

Uma classe otimizada para aços inoxidáveis. Para torneamento externo e interno e, operações de desbaste a usinagem média, com e sem usinagem. Para condições estáveis com cortes contínuos a levemente interrompidos, em velocidades de corte altas a médias.



GC2035 (HC) – M35 (M25-M40)

Uma classe de metal duro com cobertura PVD. Deve ser usado para semiacabamento ao desbaste em velocidades de corte baixas a moderadas.

Classes complementares



GC1115 (HC) – M15 (M05-M25)

Uma classe de metal duro com cobertura PVD. Recomendada para uso com faixas de avanço baixas ou velocidades de corte médias.



GC1125 (HC) – M25 (M10-M30)

Uma classe com cobertura PVD para operações que exijam tenacidade.

Letras-símbolo especificando a designação de materiais de corte duros:

Metais duros:

- HW Metal duro sem cobertura contendo principalmente carboneto de tungstênio (WC)
- HT Metal duro sem cobertura, também chamado cermet, contendo principalmente carbonetos de titânio (TiC) ou nitretos de titânio (TiN) ou ambos.
- HC Metais duros como acima, porém com cobertura

Cerâmicas:

- CA Cerâmicas à base de óxido contendo principalmente óxido de alumínio (Al₂O₃)
- CM Cerâmicas mistas contendo principalmente óxido de alumínio (Al₂O₃) e outros elementos além de óxidos
- CN Cerâmicas à base de nitreto, principalmente nitreto de silício (Si₃N₄)
- CC Cerâmicas como acima, porém com cobertura

Diamante:

- DP Diamante policristalino¹⁾

Nitreto de boro:

- BN Nitreto de boro policristalino¹⁾

¹⁾ Diamante policristalino e nitreto de boro policristalino são também denominados materiais de corte superduros.

Classes para torneamento geral



Ferros fundidos, ferros fundidos coquilhados, ferros maleáveis de cavacos curtos.

Classes básicas



GC3210 (HC) – K10 (K01-K20)

Uma classe de metal duro com cobertura CVD. Deve ser usada em condições de usinagem boas a médias e em todos os materiais de ferro fundido. Uma classe adequada para cortes contínuos e interrompidos.

Classes complementares



H13A (HW) – K20 (K10-K30)

Classe de metal duro sem cobertura. Para velocidades moderadas a baixas e altos avanços em ferros fundidos.



GC3225 (HC) – K25 (K15-K35)

Uma classe de metal duro com cobertura CVD. Deve ser usada em condições de usinagem média à difícil em todos os materiais de ferros fundidos. Uma classe adequada para cortes muito interrompidos a levemente interrompidos.



CB7525 (BN) - K05 (K01-K10)

Uma classe de nitreto cúbico de boro. Para acabamento com altas velocidades de ferros fundidos cinzentos em condições com interrupções bem como cortes contínuos.



CC6190 (CN) – K10 (K05 – K15)

Cerâmica à base de nitreto de silício puro. Deve ser usada do desbaste com alta velocidade ao acabamento de ferros fundidos, com boas condições. Consegue lidar com algumas interrupções.



CC650 (CM) – K01 (K01-K05)

Cerâmica mista à base de Al_2O_3 . Recomendada para acabamento com altas velocidades, sob condições estáveis, de ferros fundidos cinzentos e ferros fundidos endurecidos.



CB7925 (BN) - K05 (K01-K10)

Uma classe de nitreto cúbico de boro. Adequada para usinagem de ferros fundidos cinzentos e coquilhados, em condição de cortes interrompidos assim como contínuos.

Letras-símbolo especificando a designação de materiais de corte duros:

Metais duros:

HW Metal duro sem cobertura contendo principalmente carboneto de tungstênio (WC)

HT Metal duro sem cobertura, também chamado cermet, contendo principalmente carbonetos de titânio (TiC) ou nitretos de titânio (TiN) ou ambos.

HC Metais duros como acima, porém com cobertura

Cerâmicas:

CA Cerâmicas à base de óxido contendo principalmente óxido de alumínio (Al_2O_3)

CM Cerâmicas mistas contendo principalmente óxido de alumínio (Al_2O_3) e outros elementos além de óxidos

CN Cerâmicas à base de nitreto, principalmente nitreto de silício (Si_3N_4)

CC Cerâmicas como acima, porém com cobertura

Diamante:

DP Diamante policristalino¹⁾

Nitreto de boro:

BN Nitreto de boro policristalino¹⁾

¹⁾ Diamante policristalino e nitreto de boro policristalino são também denominados materiais de corte superduros.

Classes para torneamento geral

N Metais não-ferrosos

Classes básicas



H10 (HW) – N15 (N01-N25)

Classe de metal duro sem cobertura. Para torneamento de ligas de alumínio, do desbaste ao acabamento.



CD05 – N01 (N01-N10)

Uma classe de diamante policristalino para acabamento e semiacabamento de materiais não metálicos e não ferrosos altamente abrasivos, compósitos com matriz metálica (MMC), fibra de vidro, MDF e laminados de madeira.



CD10 (DP) – N05 (N01-N10)

Uma classe de diamante policristalino para acabamento e semiacabamento de materiais não ferrosos e não metálicos.

Classes complementares



H13A (HW) - N15 (N05-N25)

Uma classe de metal duro sem cobertura para torneamento médio ao desbaste de ligas de alumínio.

Letras-símbolo especificando a designação de materiais de corte duros:

Metais duros:

- HW Metal duro sem cobertura contendo principalmente carboneto de tungstênio (WC)
- HT Metal duro sem cobertura, também chamado cermet, contendo principalmente carbonetos de titânio (TiC) ou nitretos de titânio (TiN) ou ambos.
- HC Metais duros como acima, porém com cobertura

Cerâmicas:

- CA Cerâmicas à base de óxido contendo principalmente óxido de alumínio (Al₂O₃)
- CM Cerâmicas mistas contendo principalmente óxido de alumínio (Al₂O₃) e outros elementos além de óxidos
- CN Cerâmicas à base de nitreto, principalmente nitreto de silício (Si₃N₄)
- CC Cerâmicas como acima, porém com cobertura

Diamante:

- DP Diamante policristalino¹⁾

Nitreto de boro:

- BN Nitreto de boro policristalino¹⁾

¹⁾ Diamante policristalino e nitreto de boro policristalino são também denominados materiais de corte superduros.

Classes para torneamento geral

S Super ligas e ligas resistentes ao calor

Classes básicas



CC6160 (CA) – S10 (S05-S20)

Uma classe cerâmica à base de SiAlON. Ideal para usinagem de bolsões e perfilamento de peças de superligas resistentes ao calor e difíceis de usar. Oferece usinagem segura e estável para alta taxa de remoção de metal. Executa diversas operações do desbaste ao semiacabamento.



CC6060 (CA) - S10 (S05-S20)

Uma cerâmica à base de SiAlON para usinagem em materiais pré-usinados sob condições estáveis.



CC670 (CA) – S15 (S05-S25)

Uma cerâmica à base de SiAlON reforçada com whisker. Deve ser usada principalmente sob condições desfavoráveis.



CC6065 (CA) – S15 (S10-S20)

Uma cerâmica à base de SiAlON. Bem adequada para primeiro estágio de usinagem em aplicações semi-intermitentes, bem como na usinagem de cascas forjadas e outras operações que exijam tenacidade.



GC1105 (HC) – S15 (S05-S20)

Uma classe de metal duro com cobertura PVD. Adequada para usinagem média ao acabamento.



S05F (HC) - S05 (S05-S15)

Uma classe de metal duro com cobertura CVD. Para acabamento com alta velocidade, ou longos tempos em corte com baixas velocidades. Para aplicações em que o risco de desgaste tipo entalhe não é um fator predominante.



GC1115 (HC) - S20 (S15-S25)

Uma classe de metal duro com cobertura PVD. A classe tem um excelente desempenho combinado às geometrias de aresta viva. Adequada para torneamento em desbaste ao torneamento médio em materiais abrasivos.

Classes complementares



CC650 (CM) – S05 (S01-S10)

Cerâmica mista à base de Al₂O₃. Deve ser usada em operações de semiacabamento de ligas resistentes à alta temperatura.



GC1125 (HC) – S25 (S20-S30)

Uma classe de metal duro com cobertura PVD para uso com baixas velocidades ou cortes levemente interrompidos.



H13A (HW) – S15 (S10-S30)

Classe de metal duro sem cobertura para velocidades moderadas a baixas.

S Ligas de titânio

Classes básicas



H13A (HW) – S15 (S10-S30)

Classe de metal duro sem cobertura para velocidades moderadas a baixas.

Classes complementares



GC1115 (HC) - S20 (S15-S25)

Uma classe de metal duro com cobertura PVD. A classe tem um excelente desempenho combinado às geometrias de aresta viva. Adequada para torneamento em desbaste ao torneamento médio em materiais abrasivos.

Letras-símbolo especificando a designação de materiais de corte duros:

Metais duros:

HW Metal duro sem cobertura contendo principalmente carboneto de tungstênio (WC)

HT Metal duro sem cobertura, também chamado cermet, contendo principalmente carbonetos de titânio (TiC) ou nitretos de titânio (TiN) ou ambos.

HC Metais duros como acima, porém com cobertura

Cerâmicas:

CA Cerâmicas à base de óxido contendo principalmente óxido de alumínio (Al₂O₃)

CM Cerâmicas mistas contendo principalmente óxido de alumínio (Al₂O₃) e outros elementos além de óxidos

CN Cerâmicas à base de nitreto, principalmente nitreto de silício (Si₃N₄)

CC Cerâmicas como acima, porém com cobertura

Diamante:

DP Diamante policristalino¹⁾

Nitreto de boro:

BN Nitreto de boro policristalino¹⁾

¹⁾ Diamante policristalino e nitreto de boro policristalino são também denominados materiais de corte superduros.

Classes para torneamento geral

H Materiais endurecidos

Classes básicas



CB7105 (BN) - H05 (H01-H10)

Para corte contínuo, menor profundidade de corte e menores cargas de cavacos com altas velocidades.



CB7015 (BN) - H10 (H05 - H15)

Uma classe de nitreto cúbico de boro. Deve ser usada em cortes contínuos e levemente interrompidos com alta velocidade em aços endurecidos por cementação.



CB7115 (BN) - H15 (H10-H20)

Para cortes contínuos a levemente interrompidos, ou alta carga de cavacos com velocidades médias a altas.



CB7025 (BN) - H15 (H10-H20)

Um compósito de nitreto cúbico de boro para materiais ferrosos endurecidos. Adequada para cortes com interrupções significativas, com velocidades médias em aços endurecidos por cementação e aços para rolamento.



CB7125 - H25

Médio teor de CBN e nova cobertura PVD com boa resistência à quebras e melhor vida útil da ferramenta.



CB7135 - H35

Alto teor de CBN para melhor resistência à quebras e corte muito interrompido previsível.

Classes complementares



CB7525 (BN) - H25 (H20-H30)

Classe de nitreto cúbico de boro. A alta tenacidade da aresta faz com que seja uma boa classe complementar em cortes interrompidos e em aços endurecidos.



CC6050 (CA) - H05 (H01-H10)

Cerâmica mista à base de Al₂O₃. Deve ser usada para acabamento leve e contínuo.

Letras-símbolo especificando a designação de materiais de corte duros:

Metais duros:

- HW Metal duro sem cobertura contendo principalmente carboneto de tungstênio (WC)
- HT Metal duro sem cobertura, também chamado cermet, contendo principalmente carbonetos de titânio (TIC) ou nitretos de titânio (TIN) ou ambos.
- HC Metais duros como acima, porém com cobertura

Cerâmicas:

- CA Cerâmicas à base de óxido contendo principalmente óxido de alumínio (Al₂O₃)
- CM Cerâmicas mistas contendo principalmente óxido de alumínio (Al₂O₃) e outros elementos além de óxidos
- CN Cerâmicas à base de nitreto, principalmente nitreto de silício (Si₃N₄)
- CC Cerâmicas como acima, porém com cobertura

Diamante:

- DP Diamante policristalino¹⁾

Nitreto de boro:

- BN Nitreto de boro policristalino¹⁾

¹⁾ Diamante policristalino e nitreto de boro policristalino são também denominados materiais de corte superduros.



Corte e canais

CoroCut® 1-2 B3

Visão geral B4
Pastilhas B5-B24
Ferramentas externas B25-B45

Ferramentas internas B46-B49

CoroCut® QD B50

Visão geral B51
Pastilhas B52-B56
Ferramentas externas B57-B68

CoroCut® QF B69

Pastilhas B70-B72
Ferramentas externas B73-B84
Ferramentas internas B85-B86

CoroCut® 3 B87

Visão geral B88
Pastilhas B89-B92
Ferramentas externas B93-B95

CoroCut® XS B96

Pastilhas B97-B98
Ferramentas externas B99-B100

T-Max® Q-Cut B101

Pastilhas B102-B103
Ferramentas externas B104-B106

Ferramentas internas B107-B111

CoroThread® 266 B112

Pastilhas B113
Ferramentas internas B114

CoroTurn® XS B115

Ferramentas de corte B116-B121
Adaptadores F2

CoroCut® MB B122

Ferramentas de corte B123-B128
Adaptadores F2

A

CORTES E CANAIS

POR

B

C

D

E

F

G

H

		Canais externos		Canais internos		Canais frontais	
		CW	CDX	DMIN	CDX	DAXIN	CDX
CoroCut® 1-2	Usinagem de canais com 2 arestas, canais frontais e perfilamento	1.5-15 mm	7-120 mm	25-60 mm	5-13 mm	Ø34 mm	12-28 mm
CoroCut® QD	Para cortes e canais profundos	1-8 mm	10-80 mm				
CoroCut® QF	Para usinagem de canais frontais					Ø30-60 mm	20-50 mm
CoroCut® 3	Usinagem de canais externos estreitos com 3 arestas	0.5-3.18 mm	<6,4 mm				
CoroCut® XS	Usinagem de canais externos e canais frontais em diâmetros pequenos	0.5-2.5 mm	<8,5 mm				
CoroTurn® XS	Usinagem de canais internos e canais frontais de diâmetros pequenos			4.2-8 mm	0.8-2.5 mm	Ø1-8 mm	2-30 mm
CoroCut® MB	Para usinagem de canais internos e canais frontais com alta precisão			10-20 mm	2-8 mm	Ø6-12 mm	1,5-10 mm
T-Max® Q-Cut	Usinagem de canais internos e canais frontais			12-50 mm	2-8 mm	Ø16 mm	9-20 mm
CoroThread® 266	Para operações de usinagem canais externos e internos difíceis	1,10-4,15 mm	1,3-2,6 mm	20-25 mm	1,3-2,2 mm		

CoroCut® 1-2

Operações de corte, perfilamento e usinagem de canais

Aplicação

- Corte
- Canais externos
- Canais internos
- Canais frontais
- Perfilamento

Área de aplicação ISO:



Características e benefícios

- Liga do material da ferramenta mais robusto para alta resistência à fadiga
- Adaptadores plug-and-play facilitam a conexão da refrigeração
- Fácil troca das pastilhas: não é necessário um torquímetro – sempre a fixação correta com chave de liberação rápida

Nota: Em operações de cortes e canais, o CoroCut® 1-2 é a melhor escolha para profundidades em que podem ser usadas pastilhas de 2 arestas.



www.sandvik.coromant.com/corocut1-2

Pastilhas

- Geometrias e classes para todos os avanços e aplicações
- Classes de pastilhas em materiais de corte avançados PCD e CBN
- Pastilhas Wiper para excelente acabamento superficial

Ferramentas

- Unidades de corte Coromant Capto®
- Ferramentas convencionais
- Hastes QS™
- Lâminas para cortar
- Barras de mandrilar
- Cabeças CoroTurn® SL

Fixação rígida por mola

O sistema combina o mecanismo de fixação rígida por mola com assento da pastilha tipo trilho e pastilhas longas para estabilidade excepcional.

Refrigeração superior e inferior

Ferramentas com refrigeração superior e inferior interna disponíveis para obter melhor controle de cavacos e maior vida útil da ferramenta.

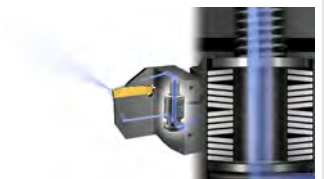

B4



B4











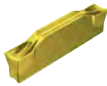
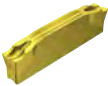

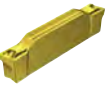
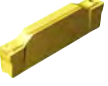

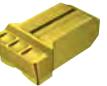

B4







H35

Pastilhas

	Cortes				Canaís				
									
	123-CF	123-CM	123-CR	123-CS	123-GF	123-GM	123-GM	123-GR	123-GS
Largura da pastilha, mm	2.50-4.00	1.50-5.00	2.50-6.00	1.50-3.00	1.50-8.00	2.00-11.00	12.00-15.00	15.00	2.00-4.00
Página	B5	B6	B7	B8	B9	B11	B12	B12	B14

	Canais	Perfilamento							
	Materiais endurecidos								
	123-S	123-RO	123-RM	123-AM	123-RS	123-RE	123-RO	123-RS	
Largura da pastilha, mm	3.00-8.00	2.00-8.00	3.00-8.00	6.00-8.00	3.00-8.00	2.00-8.00	2.00-4.00	2.00-4.00	
Página	B13	B18	B19	B22	B24	B23	B20	B20	

	Perfilamento	Torneamento				
	Materiais endurecidos					
	123-S	123-RE	123-TF	123-TM	123-XB	
Largura da pastilha, mm	3.00-8.00	2.00-8.00	3.00-8.00	3.00-8.00	3.00-5.00	
Página	B24	B23	B15	B16	B17	

Ferramentas

					
Sistemas de fixação	Cortes e canais	Cortes	Canaís	Canaís frontais	Perfilamento
Coromant Capto®	B25-B27			B38	
Lâmina		B33-B34			
Haste	B28-B31		B35	B39	B43
Haste QS	B32			B40	
Cabeça de corte SL externa			B36-B37	B41-B42	B44-B45
Cabeça de corte SL interna			B46		
Barra de mandrilar interna			B47-B48		B49

Pastilha CoroCut® 1-2 para cortes



L123x2-CS

R123x2-CS

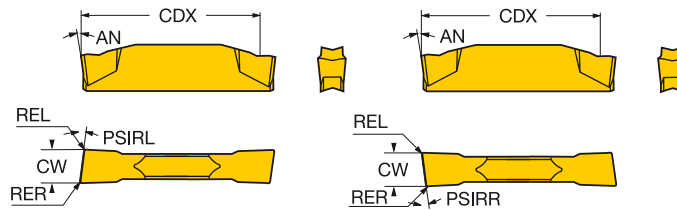

CoroCut® 2-arestas

Acabamento	SSC	CW	REL	RER	CDX	PSIRL	PSIRR	Código para pedido	P	M	K	N	S	AN	Dimensões, mm
									1125	1125	1125	1125	1125		
									*	*	*	*	*		
	D	1.50	0.10	0.10	13.4	10°		L123D2-0150-1001-CS	*	*	*	*	*	5°	
		1.50	0.10	0.10	13.4	15°		L123D2-0150-1501-CS	*	*	*	*	*	5°	
	E	2.00	0.10	0.10	19.4	10°		L123E2-0200-1001-CS	*	*	*	*	*	5°	
		2.00	0.10	0.10	19.4	15°		L123E2-0200-1501-CS	*	*	*	*	*	5°	
	F	2.50	0.10	0.10	19.4	10°		L123F2-0250-1001-CS	*	*	*	*	*	5°	
		2.50	0.10	0.10	19.4	15°		L123F2-0250-1501-CS	*	*	*	*	*	5°	
	G	3.00	0.10	0.10	19.4	10°		L123G2-0300-1001-CS	*	*	*	*	*	5°	
		3.00	0.10	0.10	19.4	15°		L123G2-0300-1501-CS	*	*	*	*	*	5°	
	D	1.50	0.10	0.10	13.4	10°		R123D2-0150-1001-CS	*	*	*	*	*	5°	
		1.50	0.10	0.10	13.4	15°		R123D2-0150-1501-CS	*	*	*	*	*	5°	
	E	2.00	0.10	0.10	19.4	10°		R123E2-0200-1001-CS	*	*	*	*	*	5°	
		2.00	0.10	0.10	19.4	15°		R123E2-0200-1501-CS	*	*	*	*	*	5°	
	F	2.50	0.10	0.10	19.4	10°		R123F2-0250-1001-CS	*	*	*	*	*	5°	
		2.50	0.10	0.10	19.4	15°		R123F2-0250-1501-CS	*	*	*	*	*	5°	
G	3.00	0.10	0.10	19.4	10°		R123G2-0300-1001-CS	*	*	*	*	*	5°		
	3.00	0.10	0.10	19.4	15°		R123G2-0300-1501-CS	*	*	*	*	*	5°		

SSC = Para corresponder ao SSC no suporte.

R = versão direita, L = versão esquerda

Tolerâncias:				
	CWTOLL	CWTOLU	RETOLL	RETOLU
L123x2-CS	-0.020	0.020	-0.05	0.05
R123x2-CS	-0.020	0.020	-0.05	0.05



Pastilha CoroCut® 1-2 para canais

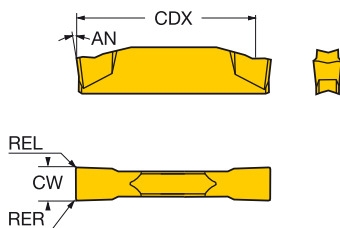

CoroCut® 2-arestas

Acabamento	SSC	CW	REL	RER	CDX	Código para pedido	P				M			K		N			S			H	Dimensões, mm				
							1105	1125	2135	325	1105	1125	2135	HT3A	1125	2135	HT3A	1105	1125	2135	HT3A	1105		1125	2135	HT3A	2135
							☆	☆	☆	☆	☆	☆	☆	☆	☆	☆	☆	☆	☆	☆	☆	☆		☆	☆	☆	☆
	D	1.50	0.10	0.10	13.3	N123D2-0150-0001-GF	☆	☆																5°			
	E	1.98	0.20	0.20	19.2	N123E2-0198-0002-GF	☆	☆																	7°		
		2.00	0.20	0.20	19.2	N123E2-0200-0002-GF	☆	☆	☆	☆															7°		
		2.00	0.40	0.40	19.2	N123E2-0200-0004-GF	☆	☆																	7°		
		2.24	0.20	0.20	19.2	N123E2-0224-0002-GF	☆	☆																	7°		
	F	2.39	0.20	0.20	19.2	N123F2-0239-0002-GF	☆	☆																	7°		
		2.39	0.40	0.40	19.2	N123F2-0239-0004-GF	☆	☆																	7°		
		2.46	0.30	0.30	19.1	N123F2-0246-0003-GF	☆	☆																	7°		
		2.67	0.20	0.20	19.2	N123F2-0267-0002-GF	☆	☆																	7°		
		2.79	0.30	0.30	19.1	N123F2-0279-0003-GF	☆	☆																	7°		
	G	3.00	0.20	0.20	19.2	N123G2-0300-0002-GF	☆	☆	☆	☆															7°		
		3.00	0.40	0.40	19.2	N123G2-0300-0004-GF	☆	☆																	7°		
		3.10	0.20	0.20	19.2	N123G2-0310-0002-GF	☆	☆																	7°		
		3.18	0.20	0.20	19.2	N123G2-0318-0002-GF	☆	☆																	7°		
		3.18	0.40	0.40	19.2	N123G2-0318-0004-GF	☆	☆																	7°		
		3.18	0.80	0.80	19.2	N123G2-0318-0008-GF	☆	☆																	7°		
		3.61	0.30	0.30	19.1	N123G2-0361-0003-GF	☆	☆																	7°		
	H	3.96	0.20	0.20	24.4	N123H2-0396-0002-GF	☆	☆																	7°		
		3.96	0.40	0.40	24.4	N123H2-0396-0004-GF	☆	☆																	7°		
		3.96	0.80	0.80	24.4	N123H2-0396-0008-GF	☆	☆																	7°		
		4.00	0.20	0.20	24.4	N123H2-0400-0002-GF	☆	☆	☆	☆															7°		
		4.00	0.40	0.40	24.4	N123H2-0400-0004-GF	☆	☆																	7°		
		4.52	0.20	0.20	24.4	N123H2-0452-0002-GF	☆	☆																	7°		
		4.70	0.50	0.50	24.1	N123H2-0470-0005-GF	☆	☆																	7°		
		4.75	0.40	0.40	24.1	N123H2-0475-0004-GF	☆	☆																	7°		
		4.75	0.80	0.80	24.1	N123H2-0475-0008-GF	☆	☆																	7°		
		4.80	0.50	0.50	24.1	N123H2-0480-0005-GF	☆	☆																	7°		
		5.00	0.20	0.20	24.4	N123H2-0500-0002-GF	☆	☆	☆	☆															7°		
	5.00	0.40	0.40	24.4	N123H2-0500-0004-GF	☆	☆																	7°			
J	5.41	0.20	0.20	24.4	N123J2-0541-0002-GF	☆	☆																	7°			
	5.56	0.50	0.50	24.1	N123J2-0556-0005-GF	☆	☆																	7°			
K	6.00	0.20	0.20	24.4	N123K2-0600-0002-GF	☆	☆	☆	☆															7°			
	6.35	0.40	0.40	24.1	N123K2-0635-0004-GF	☆	☆																	7°			
	6.35	0.50	0.50	24.1	N123K2-0635-0005-GF	☆	☆																	7°			
	6.35	0.80	0.80	24.1	N123K2-0635-0008-GF	☆	☆																	7°			
	7.14	0.80	0.80	23.8	N123K2-0714-0008-GF	☆	☆																	7°			
L	7.92	0.80	0.80	29.0	N123L2-0792-0008-GF	☆	☆																	7°			
	8.00	0.20	0.20	29.6	N123L2-0800-0002-GF	☆	☆																	7°			

SSC = Para corresponder ao SSC no suporte.

N = neutra

Tolerâncias:	CWTOLL	CWTOLU	RETOLL	RETOLU
N123x2-GF	-0.020	0.020	-0.05	0.05



Pastilha CoroCut® 1-2 para canais

Para canais circlip

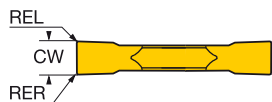
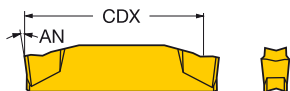

C CoroCut® 2-arestas

Acabamento	SSC	CW	REL	RER	CDX	Código para pedido	Dimensões, mm												
							P		M		K		N		S		GB	BN	AN
							1105	1125	1105	1125	1105	1125	1105	1125	1105	1125	1105	1125	25°
	E	1.85	0.10	0.10	19.3	N123E2-0185-0001-GF	☆	★	☆	★	☆	★	☆	★	☆	★	☆	★	
		2.15	0.10	0.10	19.3	N123E2-0215-0001-GF	★	★	★	★	★	★	★	★	★	★	★	★	
	F	2.65	0.20	0.20	19.2	N123F2-0265-0002-GF	★	★	★	★	★	★	★	★	★	★	★	★	
		3.15	0.20	0.20	19.2	N123G2-0315-0002-GF	★	★	★	★	★	★	★	★	★	★	★	★	
	H	4.15	0.20	0.20	24.4	N123H2-0415-0002-GF	★	★	★	★	★	★	★	★	★	★	★	★	
J	5.15	0.20	0.20	24.4	N123J2-0515-0002-GF	★	★	★	★	★	★	★	★	★	★	★	★		

SSC = Para corresponder ao SSC no suporte.

N = neutra

Tolerâncias:

	CWTOLL	CWTOLU	RETOLL	RETOLU
N123x2-GF (CIRCLIP)	0.090	0.130	-0.05	0.05



Pastilha CoroCut® 1-2 para canais

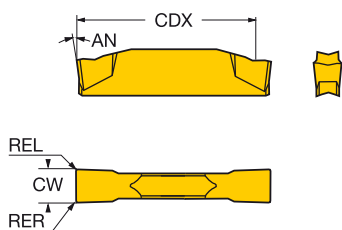

CoroCut® 2-arestas

Média	SSC	CW	REL	RER	CDX	Código para pedido	P				M			K			N			S			Dimensões, mm			
							1125	1145	2135	3115	1125	1145	H13A	1125	2135	3115	4325	H13A	1125	2135	H13A	1125		1145	2135	H13A
							☆	☆	★	☆	☆	☆	☆	☆	☆	☆	☆	☆	☆	☆	☆	☆		☆	☆	☆
	E	2.00	0.20	0.20	18.8	N123E2-0200-0002-GM	☆	☆	★	☆	☆	☆	☆	☆	☆	☆	☆	☆	☆	☆	☆	☆	☆	7°		
		2.39	0.20	0.20	18.4	N123E2-0239-0002-GM	☆	☆	★	☆	☆	☆	☆	☆	☆	☆	☆	☆	☆	☆	☆	☆	☆	7°		
	G	3.00	0.30	0.30	18.2	N123G2-0300-0003-GM	☆	☆	★	☆	☆	☆	☆	☆	☆	☆	☆	☆	☆	☆	☆	☆	☆	7°		
		3.18	0.30	0.30	18.0	N123G2-0318-0003-GM	☆	☆	★	☆	☆	☆	☆	☆	☆	☆	☆	☆	☆	☆	☆	☆	☆	7°		
	H	4.00	0.30	0.30	23.0	N123H2-0400-0003-GM	☆	☆	★	☆	☆	☆	☆	☆	☆	☆	☆	☆	☆	☆	☆	☆	☆	7°		
	J	4.75	0.30	0.30	22.6	N123J2-0475-0003-GM	☆	☆	★	☆	☆	☆	☆	☆	☆	☆	☆	☆	☆	☆	☆	☆	☆	7°		
		5.00	0.40	0.40	22.9	N123J2-0500-0004-GM	☆	☆	★	☆	☆	☆	☆	☆	☆	☆	☆	☆	☆	☆	☆	☆	☆	7°		
	K	6.00	0.40	0.40	22.7	N123K2-0600-0004-GM	☆	☆	★	☆	☆	☆	☆	☆	☆	☆	☆	☆	☆	☆	☆	☆	☆	7°		
		6.35	0.25	0.25	22.6	N123K2-0635-0003-GM	☆	☆	★	☆	☆	☆	☆	☆	☆	☆	☆	☆	☆	☆	☆	☆	☆	7°		
	L	7.92	0.30	0.30	28.7	N123L2-0792-0003-GM	☆	☆	★	☆	☆	☆	☆	☆	☆	☆	☆	☆	☆	☆	☆	☆	☆	7°		
		8.00	0.50	0.50	28.4	N123L2-0800-0005-GM	☆	☆	★	☆	☆	☆	☆	☆	☆	☆	☆	☆	☆	☆	☆	☆	☆	7°		
	M	9.05	0.80	0.80	28.0	N123M2-0900-0008-GM	☆	☆	★	☆	☆	☆	☆	☆	☆	☆	☆	☆	☆	☆	☆	☆	☆	7°		
		10.00	0.80	0.80	28.0	N123M2-1000-0008-GM	☆	☆	★	☆	☆	☆	☆	☆	☆	☆	☆	☆	☆	☆	☆	☆	☆	7°		

SSC = Para corresponder ao SSC no suporte.

N = neutra

Tolerâncias:

Código para pedido	CWTOLL	CWTOLU	RETOLL	RETOLU
N123E2-0200-0002-GM	0.000	0.100	-0.10	0.10
N123E2-0239-0002-GM	-0.050	0.050	-0.10	0.10
N123G2-0300-0003-GM	0.000	0.100	-0.10	0.10
N123G2-0318-0003-GM	-0.050	0.050	-0.10	0.10
N123H2-0400-0003-GM	0.000	0.100	-0.10	0.10
N123J2-0475-0003-GM	-0.050	0.050	-0.10	0.10
N123J2-0500-0004-GM	0.000	0.100	-0.10	0.10
N123K2-0600-0004-GM	0.000	0.100	-0.10	0.10
N123K2-0635-0003-GM	-0.050	0.050	-0.10	0.10
N123L2-0792-0003-GM	-0.050	0.050	-0.10	0.10
N123L2-0800-0005-GM	0.000	0.100	-0.10	0.10
N123M2-0900-0008-GM	-0.100	0.100	-0.10	0.10
N123M2-1000-0008-GM	-0.100	0.100	-0.10	0.10



B4



B4



B130



B149

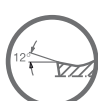

B138



H36



H35

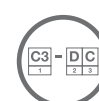

H17

Pastilha CoroCut® 1-2 para canais

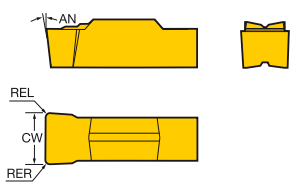

C CoroCut® 1 aresta

	SSC	CW	REL	RER	Código para pedido	P		M			K		N		S			Dimensões, mm				
						1105	1125	1145	2135	1105	1125	1145	2135	H13A	1125	2135	4325		H13A	1105	1125	1145
Média	M	9.00	0.80	0.80	N123M1-0900-0008-GM	☆	★	☆	☆	☆	☆	☆	☆	☆	☆	☆	☆	☆	☆	AN		
					N123M1-0953-0008-GM	☆	★	☆	☆	☆	☆	☆	☆	☆	☆	☆	☆	☆	☆	☆	7°	
					N123M1-1000-0008-GM	☆	★	☆	☆	☆	☆	☆	☆	☆	☆	☆	☆	☆	☆	☆	☆	7°
					N123M1-1100-0008-GM	☆	★	☆	☆	☆	☆	☆	☆	☆	☆	☆	☆	☆	☆	☆	☆	7°
					N123R1-1200-0008-GM	☆	★	☆	☆	☆	☆	☆	☆	☆	☆	☆	☆	☆	☆	☆	☆	13°
Desbaste	R	12.00	0.80	0.80	N123R1-1270-0008-GM	☆	★	☆	☆	☆	☆	☆	☆	☆	☆	☆	☆	☆	13°			
					N123R1-1500-0008-GM	☆	★	☆	☆	☆	☆	☆	☆	☆	☆	☆	☆	☆	☆	☆	13°	
					N123R1-1500-0010-GR	☆	★	☆	☆	☆	☆	☆	☆	☆	☆	☆	☆	☆	☆	☆	☆	13°

SSC = Para corresponder ao SSC no suporte. N = neutra

Tolerâncias:

Código para pedido	CWTOLL	CWTOLU	RETOLL	RETOLU
N123M1-0900-0008-GM	-0.030	0.030	-0.05	0.05
N123M1-0953-0008-GM	-0.030	0.030	-0.05	0.05
N123M1-1000-0008-GM	-0.030	0.030	-0.05	0.05
N123M1-1100-0008-GM	-0.030	0.030	-0.05	0.05
N123R1-1200-0008-GM	-0.100	0.100	-0.10	0.10
N123R1-1270-0008-GM	-0.100	0.100	-0.10	0.10
N123R1-1500-0008-GM	-0.100	0.100	-0.10	0.10
N123R1-1500-0010-GR	-0.080	0.080	-0.10	0.10

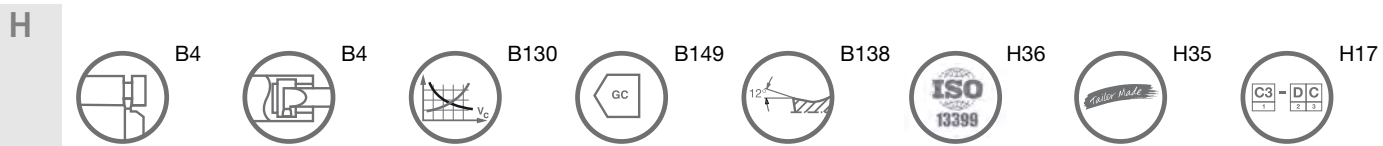

Pastilha CoroCut® 1-2 para canais

Para canais em materiais endurecidos.

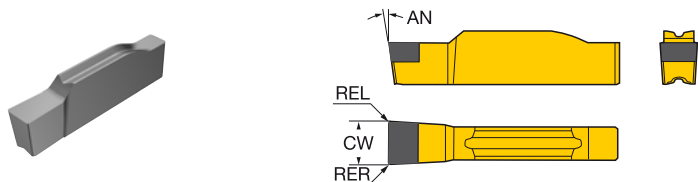

CoroCut® 1 aresta

	SSC	CW	RE	REL	RER	Código para pedido	S H		Dimensões, mm		
							7015	7015	GB	BN	AN
	G	3.00		0.40	0.40	N123G1-030004S01025	★	★	25°	0.1	7°
	H	4.00		0.40	0.40	N123H1-040004S01025	★	★	25°	0.1	7°
		5.00		0.40	0.40	N123H1-050004S01025	★	★	25°	0.1	7°
	J	6.00		0.40	0.40	N123J1-060004S01025	★	★	25°	0.1	7°
	L	8.00	0.80	0.80	0.80	N123L1-080008S01025	★	★	25°	0.1	7°

SSC = Para corresponder ao SSC no suporte.

N = neutra

Tolerâncias:

	CWTOLL	CWTOLU	RETOLL	RETOLU
N123x1..S	-0.020	0.020	-0.05	0.05



Pastilha CoroCut® 1-2 para canais

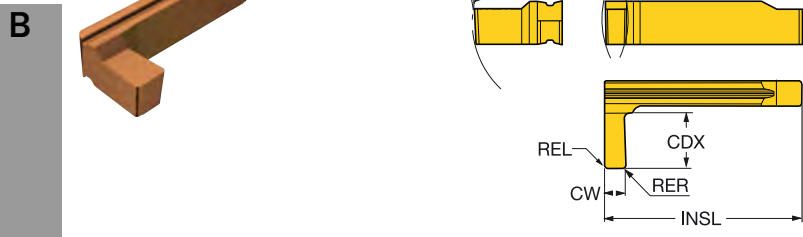

									P	M	Dimensões, mm		
		SSC	CW	REL	RER	CDX	DMIN ₁	DAXIN	Código para pedido		1115	1115	AN
Acabamento		HX	2.00	0.20	0.20	4.0	44.0	100.0	R/LG123H1-0200-0002-GS	★	★	7°	
			3.00	0.20	0.20	5.0	44.0	98.0	R/LG123H1-0300-0002-GS	★	★	7°	
			4.00	0.40	0.40	6.0	44.0	96.0	R/LG123H1-0400-0004-GS	★	★	7°	
		LX	2.00	0.20	0.20	6.0	62.0	143.0	R/LG123L1-0200-0002-GS	★	★	7°	
			3.00	0.20	0.20	9.0	62.0	141.0	R/LG123L1-0300-0002-GS	★	★	7°	
			4.00	0.40	0.40	9.0	62.0	139.0	R/LG123L1-0400-0004-GS	★	★	7°	

D SSC = Para corresponder ao SSC no suporte. R = versão direita, L = versão esquerda

Tolerâncias:

	CWTOLL	CWTOLU	RETOLL	RETOLU
R/LG123..-GS	-0.020	0.020	-0.05	0.05

E

F

G

H

B4

B4

B130

B149

B138

H36

H35

H17

Pastilha CoroCut® 1-2 para torneamento



Wiper TECHNOLOGY

N123x2-TF

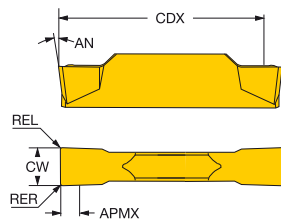

N123x1-TF

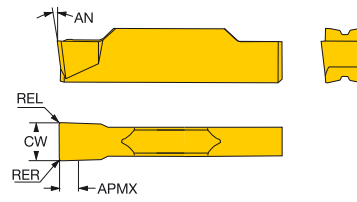

CoroCut® 1 aresta

Acabamento	SSC	CW	REL	RER	CDX	Código para pedido	Dimensões, mm																													
							P					M					K					N					S					H				
							1125	1145	2135	3115	4325	1125	1145	2135	H13A	1125	2135	3115	4325	H13A	1125	2135	H13A	1125	1145	2135	H13A	1125	2135	H13A						
G	3.00	0.30	0.30	0.30	18.5	N123G1-0300-0003-TF	☆	☆	☆	☆	☆	☆	☆	☆	☆	☆	☆	☆	☆	☆	☆	☆	☆	☆	☆	☆	☆	☆	☆	☆	☆	AN	7°			
H	4.00	0.40	0.40	0.40	23.3	N123H1-0400-0004-TF	☆	☆	☆	☆	☆	☆	☆	☆	☆	☆	☆	☆	☆	☆	☆	☆	☆	☆	☆	☆	☆	☆	☆	☆	☆	AN	7°			
K	6.00	0.40	0.40	0.40	23.3	N123K1-0600-0004-TF	☆	☆	☆	☆	☆	☆	☆	☆	☆	☆	☆	☆	☆	☆	☆	☆	☆	☆	☆	☆	☆	☆	☆	☆	☆	AN	7°			

CoroCut® 2-arestas

Acabamento	SSC	CW	REL	RER	CDX	Código para pedido	Dimensões, mm																													
							P					M					K					N					S					H				
							1105	1125	1145	2135	3115	1105	1125	1145	2135	H13A	1125	2135	3115	4325	H13A	1105	1125	2135	H13A	1105	1125	1145	2135	H13A	1105	1125	1145	2135	H13A	
G	3.00	0.30	0.30	0.30	18.5	N123G2-0300-0003-TF	☆	☆	☆	☆	☆	☆	☆	☆	☆	☆	☆	☆	☆	☆	☆	☆	☆	☆	☆	☆	☆	☆	☆	☆	☆	AN	7°			
H	4.00	0.40	0.40	0.40	23.3	N123H2-0400-0004-TF	☆	☆	☆	☆	☆	☆	☆	☆	☆	☆	☆	☆	☆	☆	☆	☆	☆	☆	☆	☆	☆	☆	☆	☆	☆	AN	7°			
J	5.00	0.40	0.40	0.40	23.3	N123J2-0500-0004-TF	☆	☆	☆	☆	☆	☆	☆	☆	☆	☆	☆	☆	☆	☆	☆	☆	☆	☆	☆	☆	☆	☆	☆	☆	☆	AN	7°			
K	6.00	0.40	0.40	0.40	23.3	N123K2-0600-0004-TF	☆	☆	☆	☆	☆	☆	☆	☆	☆	☆	☆	☆	☆	☆	☆	☆	☆	☆	☆	☆	☆	☆	☆	☆	☆	AN	7°			
L	8.00	0.80	0.80	0.80	28.0	N123L2-0800-0008-TF	☆	☆	☆	☆	☆	☆	☆	☆	☆	☆	☆	☆	☆	☆	☆	☆	☆	☆	☆	☆	☆	☆	☆	☆	☆	AN	7°			

SSC = Para corresponder ao SSC no suporte.

N = neutra

Tolerâncias:

	CWTOLL	CWTOLU	RETOLL	RETOLU
N123x1-TF	0.000	0.100	-0.10	0.10
N123x2-TF	0.000	0.100	-0.10	0.10



B4



B4

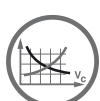

B130



B149



B138



H36



H35



H17

Pastilha CoroCut® 1-2 para torneamento

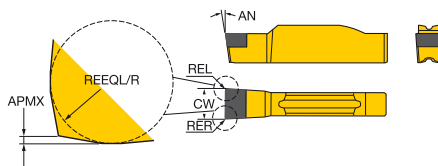
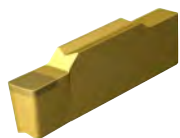

CoroCut® 1 aresta

								H		Dimensões, mm								
		SSC	CW	REEQL	REEQR	REL	RER	Código para pedido		7105	7115	GB	BN	AN	CWTOLL	CWTOLU	RETOLL	RETOLU
Acabamento	G	3.00	1.60	1.60	0.40	0.40		N123G1-0300S01025-XB	☆	★	25°	0.1	7°	-0.020	0.020	-0.050	0.050	
	J	5.00	2.60	2.60	0.20	0.20		N123J1-0500S01025-XB	☆	★	25°	0.1	7°	-0.020	0.020	-0.050	0.050	

N = neutra



H36



H17



Pastilha CoroCut® 1-2 para perfilamento



N123x1-RO

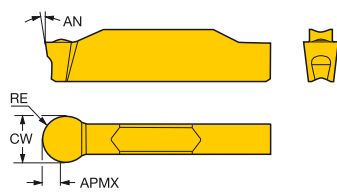

N123x2-RO

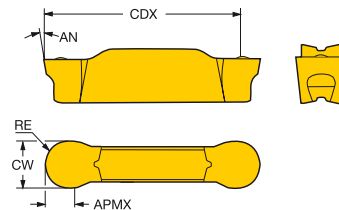

CoroCut® 1 aresta

Acabamento	SSC	CW	RE	Código para pedido	Dimensões, mm											
					P		M			K	N		S			AN
					1105	1125	1105	1125	S05F	1125	1105	1125	1105	1125	S05F	
	F	3.00	1.50	N123F1-0300-RO	☆	★	☆	☆	☆	☆	☆	☆	☆	☆	☆	7°
		3.18	1.59	N123F1-0318-RO	☆	★	☆	☆	☆	☆	☆	☆	☆	☆	☆	7°
	H	4.00	2.00	N123H1-0400-RO	☆	★	☆	☆	☆	☆	☆	☆	☆	☆	☆	7°
		4.75	2.38	N123H1-0475-RO	☆	★	☆	☆	☆	☆	☆	☆	☆	☆	☆	7°
	J	6.00	3.00	N123J1-0600-RO	☆	★	☆	☆	☆	☆	☆	☆	☆	☆	☆	7°
	L	8.00	4.00	N123L1-0800-RO	☆	★	☆	☆	☆	☆	☆	☆	☆	☆	☆	7°

CoroCut® 2-arestas

Acabamento	SSC	CW	RE	CDX	Código para pedido	Dimensões, mm														
						P			M				K	N			S			H
						1105	1125	2135	1105	1125	2135	H13A	S05F	1125	2135	H13A	1105	1125	2135	H13A
	E	2.00	1.00	19.2	N123E2-0200-RO	☆	★	☆	☆	☆	☆	☆	☆	☆	☆	☆	☆	☆	☆	7°
		2.39	1.20	19.0	N123E2-0239-RO	☆	★	☆	☆	☆	☆	☆	☆	☆	☆	☆	☆	☆	☆	7°
	F	3.00	1.50	18.7	N123F2-0300-RO	☆	★	☆	☆	☆	☆	☆	☆	☆	☆	☆	☆	☆	☆	7°
		3.18	1.59	18.6	N123F2-0318-RO	☆	★	☆	☆	☆	☆	☆	☆	☆	☆	☆	☆	☆	☆	7°
	H	3.96	1.98	23.3	N123H2-0396-RO	☆	★	☆	☆	☆	☆	☆	☆	☆	☆	☆	☆	☆	☆	7°
		4.00	2.00	23.3	N123H2-0400-RO	☆	★	☆	☆	☆	☆	☆	☆	☆	☆	☆	☆	☆	☆	7°
		4.50	2.25	23.0	N123H2-0450-RO	☆	★	☆	☆	☆	☆	☆	☆	☆	☆	☆	☆	☆	☆	7°
		4.75	2.38	22.9	N123H2-0475-RO	☆	★	☆	☆	☆	☆	☆	☆	☆	☆	☆	☆	☆	☆	7°
	J	5.00	2.50	22.8	N123H2-0500-RO	☆	★	☆	☆	☆	☆	☆	☆	☆	☆	☆	☆	☆	☆	7°
		6.00	3.00	22.2	N123J2-0600-RO	☆	★	☆	☆	☆	☆	☆	☆	☆	☆	☆	☆	☆	☆	7°
	K	6.35	3.18	22.0	N123J2-0635-RO	☆	★	☆	☆	☆	☆	☆	☆	☆	☆	☆	☆	☆	☆	7°
		7.14	3.57	21.6	N123K2-0714-RO	☆	★	☆	☆	☆	☆	☆	☆	☆	☆	☆	☆	☆	☆	7°
L	8.00	4.00	27.3	N123L2-0800-RO	☆	★	☆	☆	☆	☆	☆	☆	☆	☆	☆	☆	☆	☆	7°	

SSC = Para corresponder ao SSC no suporte.

N = neutra

Tolerâncias:				
	CWTOLL	CWTOLU	RETOLL	RETOLU
N123x1-RO	-0.020	0.020	-0.01	0.01
N123x2-RO	-0.020	0.020	-0.01	0.01



B4



B4



B130



B149

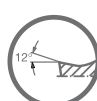

B138



H36



H35



H17

Pastilha CoroCut® 1-2 para perfilamento



N123x1-RM

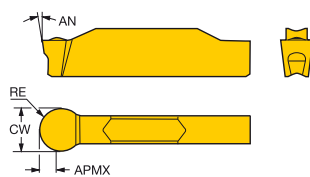

N123x2-RM

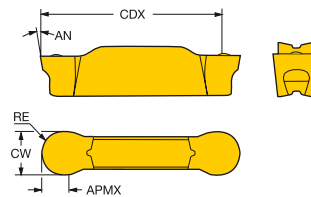

CoroCut® 1 aresta

Média	SSC	CW	RE	Código para pedido	Dimensões, mm																		
					P			M			K			N			S			H			
					1125	2135	3115	1125	2135	H13A	1125	2135	3115	4325	H13A	1125	2135	H13A	1125	2135	H13A	AN	
	G	4.00	2.00	N123G1-0400-RM	☆	★		☆	★		☆	★		☆	★		☆	★		☆	★	7°	
	J	6.00	3.00	N123J1-0600-RM	☆	★	☆	☆	★	☆	☆	☆	☆	★	☆	☆	☆	☆	★	☆	☆	☆	7°
	L	8.00	4.00	N123L1-0800-RM	★			★			☆	☆		★	☆	☆		★	★		☆	☆	7°

CoroCut® 2-arestas

Média	SSC	CW	RE	CDX	Código para pedido	Dimensões, mm																	
						P			M			K			N			S			H		
						1125	2135	3115	525	1125	2135	H13A	1125	2135	3115	4325	H13A	1125	2135	H13A	1125	2135	H13A
	F	3.00	1.50	18.6	N123F2-0300-RM	☆	★	☆	☆	☆	☆	☆	☆	☆	☆	☆	☆	☆	☆	☆	☆	☆	7°
		3.18	1.59	18.6	N123F2-0318-RM	☆	★	☆	☆	☆	☆	☆	☆	☆	☆	☆	☆	☆	☆	☆	☆	☆	7°
	G	4.00	2.00	18.1	N123G2-0400-RM	☆	★	☆	☆	☆	☆	☆	☆	☆	☆	☆	☆	☆	☆	☆	☆	☆	7°
	H	4.00	2.00	23.1	N123H2-0400-RM	☆	★	☆	☆	☆	☆	☆	☆	☆	☆	☆	☆	☆	☆	☆	☆	☆	7°
		4.75	2.38	22.9	N123H2-0475-RM	★			☆			☆		☆		☆		☆		☆		☆	7°
		5.00	2.50	22.7	N123H2-0500-RM	☆	★	☆	☆	☆	☆	☆	☆	☆	☆	☆	☆	☆	☆	☆	☆	☆	7°
	J	6.00	3.00	22.2	N123J2-0600-RM	☆	★	☆	☆	☆	☆	☆	☆	☆	☆	☆	☆	☆	☆	☆	☆	☆	7°
		6.35	3.18	22.0	N123J2-0635-RM	★			☆			☆		☆		☆		☆		☆		☆	7°
	L	8.00	4.00	27.0	N123L2-0800-RM	☆	★	☆	☆	☆	☆	☆	☆	☆	☆	☆	☆	☆	☆	☆	☆	☆	7°

SSC = Para corresponder ao SSC no suporte.

N = neutra

Tolerâncias:

Código para pedido	CWTOLL	CWTOLU	RETOLL	RETOLU
N123F2-0300-RM	0.000	0.100	-0.10	0.10
N123F2-0318-RM	-0.050	0.050	-0.10	0.10
N123G1-0400-RM	0.000	0.100	-0.10	0.10
N123G2-0400-RM	0.000	0.100	-0.10	0.10
N123H2-0400-RM	0.000	0.100	-0.10	0.10
N123H2-0475-RM	-0.050	0.050	-0.10	0.10
N123H2-0500-RM	0.000	0.100	-0.10	0.10
N123J1-0600-RM	0.000	0.100	-0.10	0.10
N123J2-0600-RM	0.000	0.100	-0.10	0.10
N123J2-0635-RM	-0.050	0.050	-0.10	0.10
N123L1-0800-RM	0.000	0.100	-0.10	0.10
N123L2-0800-RM	0.000	0.100	-0.10	0.10



B4



B4



B130



B149

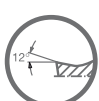

B138



H36



H35

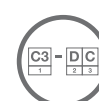

H17



Pastilha CoroCut® 1-2 para perfilamento

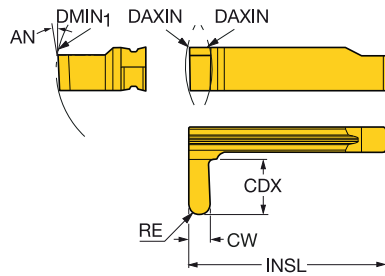

CoroCut® 1 aresta

	SSC	CW	RE	CDX	DMIN1	DAXIN	Código para pedido	P	M	S	Dimensões, mm
								1115	1115	1115	
	HX	2.00	1.00	4.0	44.0	100.0	R/LG123H1-0200-0010-RS	*	*		AN
		2.00	1.00	4.0	44.0	100.0	R/LG123H1-0200-RO	*	*		7°
		3.00	1.50	5.0	44.0	98.0	R/LG123H1-0300-0015-RS	*	*		7°
		3.00	1.50	5.0	44.0	98.0	R/LG123H1-0300-RO	*	*		7°
		4.00	2.00	6.0	44.0	96.0	R/LG123H1-0400-0020-RS	*	*		7°
	LX	2.00	1.00	6.0	62.0	143.0	R/LG123L1-0200-0010-RS	*	*	*	7°
		2.00	1.00	6.5	62.0	143.0	R/LG123L1-0200-RO	*	*		7°
		3.00	1.50	9.0	62.0	141.0	R/LG123L1-0300-0015-RS	*	*	*	7°
		3.00	1.50	9.5	62.0	141.0	R/LG123L1-0300-RO	*	*		7°
		4.00	2.00	9.0	62.0	139.0	R/LG123L1-0400-0020-RS	*	*	*	7°

SSC = Para corresponder ao SSC no suporte.
 Diâmetro mínimo do primeiro corte na usinagem de canais frontais.

R = versão direita, L = versão esquerda

Tolerâncias:

	CWTOLL	CWTOLU	RETOLL	RETOLU
R/LG123..-RO	-0.020	0.020	-0.01	0.01
R/LG123..-RS	-0.020	0.020	-0.05	0.05



Pastilha CoroCut® 1-2 para perfilamento

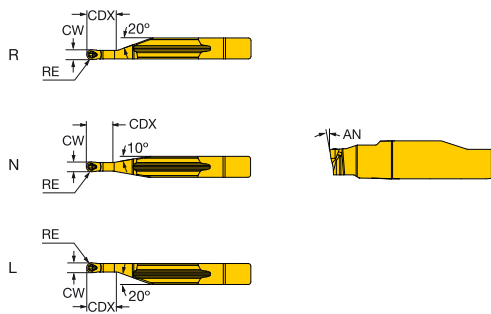

CoroCut® 1 aresta

						Dimensões, mm																				
						P		M		K		N		S												
		SSC	CW	RE	CDX	Código para pedido					1105	1125	1105	1125	S05F	1105	1125	1105	1125	S05F	AN	CWTOLL	CWTOLU	RETOLL	RETOLU	
Acabamento		HL	2.00	1.00	5.0	L123H1-0200-RO	☆	★	☆	★	☆	★	☆	★	☆	★	☆	★	☆	★	☆	7°	-0.020	0.020	-0.010	0.010
		HL	1.50	0.75	4.0	L123H1-0150-RO	☆	★	☆	★	☆	★	☆	★	☆	★	☆	★	☆	★	☆	7°	-0.020	0.020	-0.010	0.010
		HN	2.00	1.00	5.0	N123H1-0200-RO	☆	★	☆	★	☆	★	☆	★	☆	★	☆	★	☆	★	☆	7°	-0.020	0.020	-0.010	0.010
		HN	1.50	0.75	4.0	N123H1-0150-RO	☆	★	☆	★	☆	★	☆	★	☆	★	☆	★	☆	★	☆	7°	-0.020	0.020	-0.010	0.010
		HR	2.00	1.00	5.0	R123H1-0200-RO	☆	★	☆	★	☆	★	☆	★	☆	★	☆	★	☆	★	☆	7°	-0.020	0.020	-0.010	0.010
		HR	1.50	0.75	4.0	R123H1-0150-RO	☆	★	☆	★	☆	★	☆	★	☆	★	☆	★	☆	★	☆	7°	-0.020	0.020	-0.010	0.010

SSC = Para corresponder ao SSC no suporte.

N = neutra, R = versão direita, L = versão esquerda



B44



B130



H36

Pastilha CoroCut® 1-2 para perfilamento

Perfilamento de alumínio

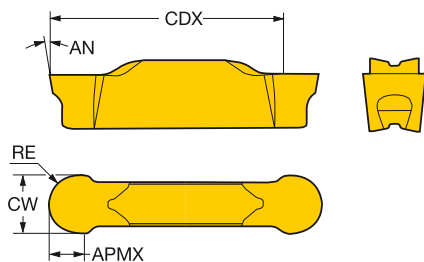
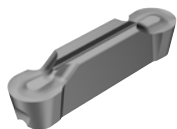

C CoroCut® 2-arestas

						N Dimensões, mm	
		SSC	CW	RE	CDX	Código para pedido	HTO AN
Média	J	6.00	3.00	22.2		N123J2-0600-AM	★ 7°
	L	8.00	4.00	27.3		N123L2-0800-AM	★ 7°

SSC = Para corresponder ao SSC no suporte. N = neutra

Tolerâncias:				
	CWTOLL	CWTOLU	RETOLL	RETOLU
N123x2-AM	-0.020	0.020	-0.02	0.02



Pastilha CoroCut® 1-2 para perfilamento

Perfilamento de materiais endurecidos e superligas resistentes ao calor

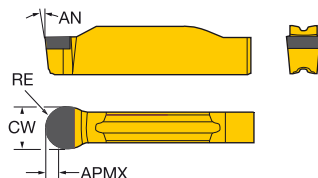

CoroCut® 1 aresta

Acabamento	SSC	CW	RE	Código para pedido	S			H			Dimensões, mm				
					7015	7015	7025	7015	7015	7025	AN	CWTOLL	CWTOLU	RETOLL	RETOLU
					*	*	*	*	*	*	*	*	*	*	*
	F	3.00	1.50	N123F1-0300-RE	*	*	*	*	*	*	7°	-0.020	0.020	-0.020	0.020
		3.18	1.59	N123F1-0318-RE	*	*	*	*	*	*	7°	-0.020	0.020	-0.020	0.020
	H	4.00	2.00	N123H1-0400-RE	*	*	*	*	*	*	7°	-0.020	0.020	-0.020	0.020
		5.00	2.50	N123H1-0500-RE	*	*	*	*	*	*	7°	-0.020	0.020	-0.020	0.020
	J	6.00	3.00	N123J1-0600-RE	*	*	*	*	*	*	7°	-0.020	0.020	-0.020	0.020
		6.35	3.18	N123J1-0635-RE	*	*	*	*	*	*	7°	-0.020	0.020	-0.020	0.020
L	8.00	4.00	N123L1-0800-RE	*	*	*	*	*	*	7°	-0.020	0.020	-0.020	0.020	

SSC = Para corresponder ao SSC no suporte.

N = neutra

N123x1-RE (SF)

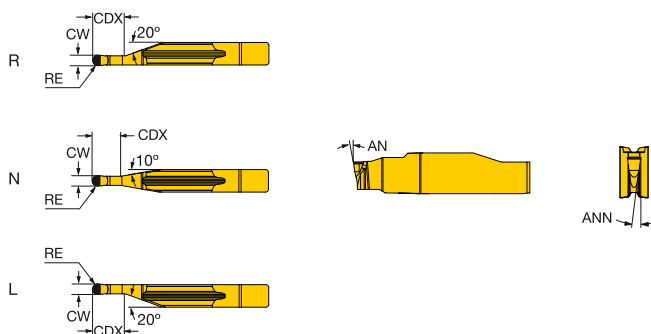

CoroCut® 1 aresta

Acabamento	SSC	CW	RE	CDX	Código para pedido	S			H			Dimensões, mm				
						7015	7015	7025	7015	7015	7025	AN	CWTOLL	CWTOLU	RETOLL	RETOLU
						*	*	*	*	*	*	*	*	*	*	*
	HL	2.00	1.00	5.0	L123H1-0200-RE	*	*	*	*	*	*	7°	-0.020	0.020	-0.010	0.010
	HN	2.00	1.00	5.0	N123H1-0200-RE	*	*	*	*	*	*	7°	-0.020	0.020	-0.010	0.010
	HR	2.00	1.00	5.0	R123H1-0200-RE	*	*	*	*	*	*	7°	-0.020	0.020	-0.010	0.010

SSC = Para corresponder ao SSC no suporte.

N = neutra, R = versão direita, L = versão esquerda



B44



B130



H36

Pastilha CoroCut® 1-2 para perfilamento

Perfilamento de materiais não ferrosos e endurecidos

B

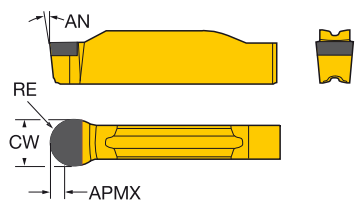

CoroCut® 1 aresta

C

Acabamento	SSC	CW	RE	Código para pedido	N S H			Dimensões, mm							
					CO10	7015	7015	GB	BN	AN	CWTOLL	CWTOLU	RETOLL	RETOLU	
	F	3.00	1.50	N123F1-0300-RS	★						7°	-0.020	0.020	-0.020	0.020
			3.00	1.50	N123F1-0300S01025	★	★		25°	0.1	7°	-0.020	0.020	-0.020	0.020
	H	4.00	2.00	N123H1-0400-RS	★						7°	-0.020	0.020	-0.020	0.020
			4.00	2.00	N123H1-0400S01025	★	★		25°	0.1	7°	-0.020	0.020	-0.020	0.020
			5.00	2.50	N123H1-0500-RS	★					7°	-0.020	0.020	-0.020	0.020
			5.00	2.50	N123H1-0500S01025	★	★		25°	0.1	7°	-0.020	0.020	-0.020	0.020
	J	6.00	3.00	N123J1-0600-RS	★						7°	-0.020	0.020	-0.020	0.020
			6.00	3.00	N123J1-0600S01025	★	★		25°	0.1	7°	-0.020	0.020	-0.020	0.020
	L	8.00	4.00	N123L1-0800-RS	★						7°	-0.020	0.020	-0.020	0.020
					N123L1-0800S01025	★	★				7°	-0.020	0.020	-0.020	0.020

SSC = Para corresponder ao SSC no suporte.

N = neutra

D



L123x1-RS (SF)

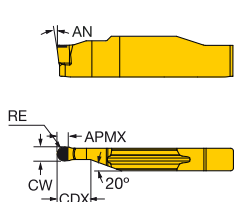

N123x1-RS (SF)

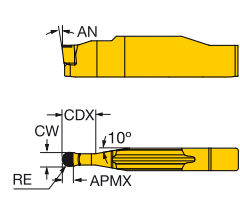

R123x1-RS (SF)

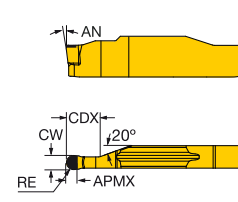

E

CoroCut® 1 aresta

Acabamento	SSC	CW	RE	CDX	Código para pedido	N			Dimensões, mm				
						CO10	AN	CWTOLL	CWTOLU	RETOLL	RETOLU		
	HL	2.00	1.00	5.0	L123H1-0200-RS	★	7°	-0.020	0.020	-0.010	0.010		
	HR	2.00	1.00	5.0	R123H1-0200-RS	★	7°	-0.020	0.020	-0.010	0.010		
	HN	2.00	1.00	5.0	N123H1-0200-RS	★	7°	-0.020	0.020	-0.020	0.020		

SSC = Para corresponder ao SSC no suporte.

N = neutra, R = versão direita, L = versão esquerda

G

H

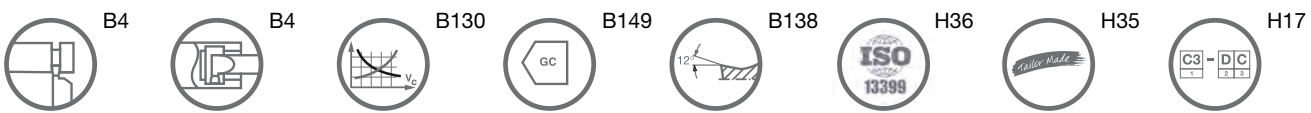

Unidade de corte CoroCut® 1-2 para cortes e canais

Trava por mecanismo tipo mola

Coromant Capto® - Refrigeração de precisão

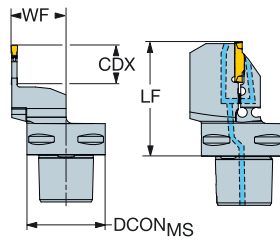

SSC	CZC _{MS}	CDX	OHX	CN5C	Código para pedido	Dimensões, mm					MIID
						DCON _{MS}	LF	WF	BAR	KG	
E	C3	15.0	55.0	3	C3-R/LF123E15C22055E	32	55.0	22.0	150	0.37	N123E2-0200-0002-CM
	C4	15.0	60.0	3	C4-R/LF123E15C27060E	40	60.0	27.0	150	0.54	N123E2-0200-0002-CM
	C5	15.0	60.0	3	C5-R/LF123E15C35060E	50	60.0	35.0	150	0.77	N123E2-0200-0002-CM
F	C3	15.0	55.0	3	C3-R/LF123F15C22055E	32	55.0	22.0	150	0.37	N123F2-0250-0002-CM
	C4	15.0	60.0	3	C4-R/LF123F15C27060E	40	60.0	27.0	150	0.55	N123F2-0250-0002-CM
	C5	20.0	65.0	3	C5-R/LF123F20C35065E	50	65.0	35.0	150	0.63	N123F2-0250-0002-CM
G	C3	15.0	55.0	3	C3-R/LF123G15C22055E	32	55.0	22.0	150	0.38	N123G2-0300-0003-TF
	C3	20.0	60.0	3	C3-R/LF123G20C22060E	32	60.0	22.0	150	0.38	N123G2-0300-0003-TF
	C4	15.0	60.0	3	C4-R/LF123G15C27060E	40	60.0	27.0	150	0.54	N123G2-0300-0003-TF
	C4	20.0	65.0	3	C4-R/LF123G20C27065E	40	65.0	27.0	150	0.55	N123G2-0300-0003-TF
	C5	15.0	60.0	3	C5-R/LF123G15C35060E	50	60.0	35.0	150	0.78	N123G2-0300-0003-TF
	C5	20.0	65.0	3	C5-R/LF123G20C35065E	50	65.0	35.0	150	0.78	N123G2-0300-0003-TF
	C6	15.0	60.0	3	C6-R/LF123G15C45060E	63	60.0	45.0	150	1.17	N123G2-0300-0003-TF
	C6	20.0	65.0	3	C6-R/LF123G20C45065E	63	65.0	45.0	150	1.18	N123G2-0300-0003-TF
H	C3	20.0	60.0	3	C3-R/LF123H20C22060E	32	60.0	22.0	150	0.38	N123H2-0400-0004-TF
	C4	20.0	65.0	3	C4-R/LF123H20C27065E	40	65.0	27.0	150	0.55	N123H2-0400-0004-TF
	C4	25.0	70.0	3	C4-R/LF123H25C27070E	40	70.0	27.0	150	0.56	N123H2-0400-0004-TF
	C5	25.0	70.0	3	C5-R/LF123H25C35070E	50	70.0	35.0	150	0.80	N123H2-0400-0004-TF
	C6	20.0	65.0	3	C6-R/LF123H20C45065E	63	65.0	45.0	150	1.20	N123H2-0400-0004-TF
	C6	25.0	70.0	3	C6-R/LF123H25C45070E	63	70.0	45.0	150	1.19	N123H2-0400-0004-TF
	C8	25.0	80.0	3	C8-R/LF123H25C51080E	80	80.0	51.0	150	2.27	N123H2-0400-0004-TF
J	C4	20.0	65.0	3	C4-R/LF123J20C27065E	40	65.0	27.0	150	0.56	N123J2-0500-0004-TF
	C4	25.0	48.8	3	C4-R/LF123J25C27070E	40	70.0	27.0	150	0.57	N123J2-0500-0004-TF
	C5	25.0	70.0	3	C5-R/LF123J25C35070E	50	70.0	35.0	150	0.80	N123J2-0500-0004-TF
	C6	25.0	70.0	3	C6-R/LF123J25C45070E	63	70.0	45.0	150	1.21	N123J2-0500-0004-TF
	C8	25.0	80.0	3	C8-R/LF123J25C51080E	80	80.0	42.0	150	2.30	N123J2-0500-0004-TF
	C4	20.0	65.0	3	C4-R/LF123K20C27065E	40	65.0	27.0	150	0.57	N123K2-0600-0004-TF
K	C4	25.0	48.8	3	C4-R/LF123K25C27070E	40	70.0	27.0	150	0.57	N123K2-0600-0004-TF
	C5	25.0	70.0	3	C5-R/LF123K25C35070E	50	70.0	35.0	150	0.81	N123K2-0600-0004-TF
	C6	25.0	70.0	3	C6-R/LF123K25C45070E	63	70.0	45.0	150	1.21	N123K2-0600-0004-TF
	C8	25.0	80.0	3	C8-R/LF123K25C51080E	80	80.0	42.0	150	2.29	N123K2-0600-0004-TF
	C5	25.0	70.0	3	C5-R/LF123L25C35070E	50	70.0	35.0	150	0.81	N123L2-0800-0008-TF
L	C6	25.0	70.0	3	C6-R/LF123L25C45070E	63	70.0	45.0	150	1.21	N123L2-0800-0008-TF
	C6	32.0	80.0	3	C6-R/LF123L32C45080E	63	80.0	45.0	150	1.28	N123L2-0800-0008-TF
	C8	32.0	85.0	3	C8-R/LF123L32C51085E	80	85.0	42.0	150	2.28	N123L2-0800-0008-TF
M	C6	32.0	80.0	3	C6-R/LF123M32C45080E	63	80.0	45.0	150	1.31	N123M2-1000-0008-GM
	C8	32.0	85.0	3	C8-R/LF123M32C51085E	80	85.0	42.0	150	2.31	N123M2-1000-0008-GM

SSC = Para corresponder ao SSC na pastilha.

R = versão direita, L = versão esquerda

Para componentes, visite www.sandvik.coromant.com



Unidade de corte CoroCut® 1-2 para cortes e canais

Fixação por parafuso

Coromant Capto® - Refrigeração interna

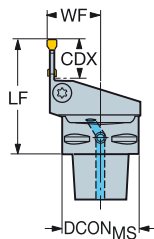

SSC	CZC _{MS}	CDX	CNSC	Código para pedido	Dimensões, mm						MIID
					DCON _{MS}	LF	WF	BAR	NM	KG	
D	C3	8.0	3	C3-R/LF123D08-22050B	32	50.0	22.0	10	2.0	0.25	N123D2-0150-0002-CM
	C3	15.0	3	C3-R/LF123D15-22050B	32	50.0	22.0	10	3.5	0.26	N123D2-0150-0002-CM
	C4	8.0	3	C4-R/LF123D08-27050B	40	50.0	27.0	10	3.0	0.40	N123D2-0150-0002-CM
	C4	15.0	3	C4-R/LF123D15-27055B	40	55.0	27.0	10	3.5	0.45	N123D2-0150-0002-CM
	C5	8.0	3	C5-R/LF123D08-35055B	50	55.0	35.0	10	2.0	0.65	N123D2-0150-0002-CM
	C5	15.0	3	C5-R/LF123D15-35055B	50	55.0	35.0	10	3.5	0.70	N123D2-0150-0002-CM
E	C3	8.0	3	C3-R/LF123E08-22050B	32	50.0	22.0	10	2.0	0.25	N123E2-0200-0002-CM
	C4	8.0	3	C4-R/LF123E08-27050B	40	50.0	27.0	10	3.7	0.40	N123E2-0200-0002-CM
	C5	8.0	3	C5-R/LF123E08-35060B	50	60.0	35.0	10	2.0	0.69	N123E2-0200-0002-CM
F	C3	10.0	3	C3-R/LF123F10-22050B	32	55.0	22.0	10	3.0	0.25	N123F2-0250-0002-CM
	C4	10.0	3	C4-R/LF123F10-27050B	40	50.0	27.0	10	5.0	0.40	N123F2-0250-0002-CM
	C5	10.0	3	C5-R/LF123F10-35060B	50	60.0	35.0	10	2.5	0.68	N123F2-0250-0002-CM
G	C3	10.0	3	C3-R/LF123G10-22050B	32	55.0	22.0	10	4.5	0.25	N123G2-0300-0003-TF
	C4	10.0	3	C4-R/LF123G10-27055B	40	55.0	27.0	10	4.0	0.41	N123G2-0300-0003-TF
	C5	10.0	3	C5-R/LF123G10-35060B	50	60.0	35.0	10	4.5	0.69	N123G2-0300-0003-TF
	C6	10.0	3	C6-R/LF123G10-45065B	63	65.0	45.0	10	3.0	1.15	N123G2-0300-0003-TF
H	C3	13.0	3	C3-R/LF123H13-22055B	32	60.0	22.0	10	4.5	0.29	N123H2-0400-0004-TF
	C4	13.0	3	C4-R/LF123H13-27055B	40	55.0	27.0	10	7.5	0.41	N123H2-0400-0004-TF
	C5	13.0	3	C5-R/LF123H13-35060B	50	60.0	35.0	10	5.0	0.68	N123H2-0400-0004-TF
	C6	13.0	3	C6-R/LF123H13-45065B	63	65.0	45.0	10	4.0	1.14	N123H2-0400-0004-TF
J	C4	13.0	3	C4-R/LF123J13-27055B	40	55.0	27.0	10	7.5	0.41	N123J2-0500-0002-CM
	C5	13.0	3	C5-R/LF123J13-35060B	50	60.0	35.0	10	5.0	0.68	N123J2-0500-0002-CM
	C6	13.0	3	C6-R/LF123J13-45065B	63	65.0	45.0	10	4.0	1.15	N123J2-0500-0002-CM
	C8	13.0	3	C8-R/LF123J13-42080B	80	80.0	42.0	10	3.5	2.29	N123J2-0500-0002-CM
K	C4	16.0	3	C4-R/LF123K16-27060B	40	60.0	27.0	10	6.5	0.44	N123K2-0600-0004-TF
	C5	16.0	3	C5-R/LF123K16-35060B	50	60.0	35.0	10	7.0	0.68	N123K2-0600-0004-TF
	C6	16.0	3	C6-R/LF123K16-45065B	63	65.0	45.0	10	5.2	1.14	N123K2-0600-0004-TF
	C8	16.0	3	C8-R/LF123K16-42080B	80	80.0	42.0	10	4.0	2.28	N123K2-0600-0004-TF
L	C5	13.0	3	C5-R/LF123L13-35060B	50	60.0	35.0	10	5.5	0.68	N123L2-0800-0008-TF
	C6	16.0	3	C6-R/LF123L16-45065B	63	65.0	45.0	10	5.5	1.13	N123L2-0800-0008-TF
	C8	25.0	3	C8-R/LF123L25-42080B	80	80.0	42.0	10	8.0	2.20	N123L2-0800-0008-TF

SSC = Para corresponder ao SSC na pastilha.

R = versão direita, L = versão esquerda

Componentes	
SSC	Parafuso
D, E, F	3212 012-259
G	3212 012-310
H, J, K, L	3212 012-360

Para a lista completa de componentes, acesse www.sandvik.coromant.com



B4



F2



E1



G1



H36



H35



H18



H5

Unidade de corte CoroCut® 1-2 para cortes e canais

Fixação por parafuso

Coromant Capto® - Refrigeração interna

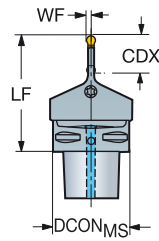

					Código para pedido	Dimensões, mm						MIID
	SSC	CZC _{MS}	CDX	CNSC		DCON _{MS}	LF	WF	BAR	NM	KG	
	G	C3	20.0	0	C3-NF123G20-00060B	32	60.0	2.0	10	5.0	0.28	N123G2-0400-RM
		C4	20.0	3	C4-NF123G20-00070B	40	70.0	2.0	10	5.0	0.50	N123G2-0400-RM
		C5	20.0	3	C5-NF123G20-00070B	50	70.0	2.0	10	5.0	0.77	N123G2-0400-RM
		C6	20.0	3	C6-NF123G20-00075B	63	75.0	2.0	10	5.0	1.30	N123G2-0400-RM
	J	C4	25.0	3	C4-NF123J25-00077B	40	77.0	3.0	10	6.0	0.52	N123J2-0500-0004-TF
		C5	25.0	3	C5-NF123J25-00077B	50	77.0	3.0	10	6.0	0.72	N123J2-0500-0004-TF
		C6	25.0	3	C6-NF123J25-00082B	63	82.0	3.0	10	6.0	1.41	N123J2-0500-0004-TF

SSC = Para corresponder ao SSC na pastilha.

N = neutra

Componentes			
SSC	CZC _{MS}	Parafuso	Olhal
G	C3-C4	3212 012-310	5691 029-01
G	C5-C6	3212 012-310	5691 029-02
J	C4	3212 012-360	5691 029-01
J	C5-C6	3212 012-360	5691 029-02

Para a lista completa de componentes, acesse www.sandvik.coromant.com



A

Ferramenta convencional CoroCut® 1-2 para cortes e canais

Trava por mecanismo tipo mola

Refrigeração de precisão

B

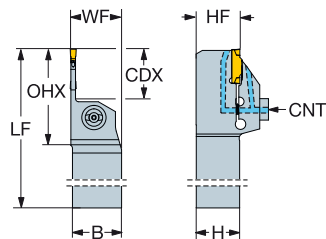
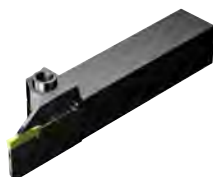

C

SSC	CZC _{MS}	CDX	OHX	CNCS	Código para pedido	Dimensões, mm							BAR	KG	MIID
						B	H	LF	WF	HF	CNT				
K	32 x 32	25.0	48.8	2	R/LF123K25C3232E	32.0	32.0	170.0	33.2	32.0	G 1/8-28	150	1.27	N123K2-0600-0004-TF	
L	32 x 32	32.0	55.4	2	R/LF123L32C3232E	32.0	32.0	170.0	33.2	32.0	G 1/8-28	150	1.23	N123L2-0800-0008-TF	
M	32 x 32	32.0	56.4	2	R/LF123M32C3232E	32.0	32.0	170.0	33.2	32.0	G 1/8-28	150	1.27	N123M2-1000-0008-GM	

D

SSC = Para corresponder ao SSC na pastilha.

R = versão direita, L = versão esquerda

Para componentes, visite www.sandvik.coromant.com

E

F

G

H



B4



F2



E1



G1



H36



H35



H18



H5

Ferramenta convencional CoroCut® 1-2 para cortes e canais

Fixação por parafuso



NF123..B

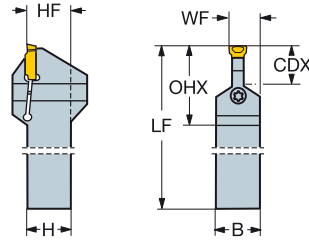

R/LF123..B

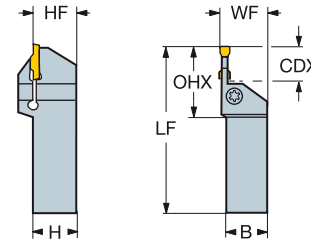

SSC	CZC _{MS}	CDX	OHX	Código para pedido	Dimensões, mm							MID
					B	H	LF	WF	HF	NM	KG	
D	16 x 16	8.0	25.5	R/LF123D08-1616B	16.0	16.0	100.0	17.0	16.0	2.5	0.22	N123D2-0150-0002-CM
	16 x 16	15.0	33.5	R/LF123D15-1616B	16.0	16.0	100.0	17.0	16.0	3.5	0.20	N123D2-0150-0002-CM
	20 x 20	8.0	25.5	R/LF123D08-2020B	20.0	20.0	125.0	21.0	20.0	2.5	0.40	N123D2-0150-0002-CM
	20 x 20	15.0	33.5	R/LF123D15-2020B	20.0	20.0	125.0	21.0	20.0	3.5	0.38	N123D2-0150-0002-CM
	25 x 25	8.0	25.5	R/LF123D08-2525B	25.0	25.0	150.0	26.0	25.0	2.5	0.72	N123D2-0150-0002-CM
	25 x 25	15.0	33.5	R/LF123D15-2525B	25.0	25.0	150.0	26.0	25.0	3.5	0.72	N123D2-0150-0002-CM
E	16 x 16	8.0	25.5	R/LF123E08-1616B	16.0	16.0	125.0	17.0	16.0	2.5	0.26	N123E2-0200-0002-CM
	16 x 16	15.0	33.5	R/LF123E15-1616B	16.0	16.0	125.0	17.0	16.0	4.0	0.25	N123E2-0200-0002-CM
	20 x 20	8.0	25.5	R/LF123E08-2020B	20.0	20.0	125.0	21.0	20.0	2.5	0.38	N123E2-0200-0002-CM
	20 x 20	15.0	33.5	R/LF123E15-2020B	20.0	20.0	125.0	21.0	20.0	4.0	0.36	N123E2-0200-0002-CM
	25 x 25	8.0	25.5	R/LF123E08-2525B	25.0	25.0	150.0	26.0	25.0	2.5	0.72	N123E2-0200-0002-CM
	25 x 25	15.0	33.5	R/LF123E15-2525B	25.0	25.0	150.0	26.0	25.0	4.0	0.69	N123E2-0200-0002-CM
F	16 x 16	10.0	29.0	R/LF123F10-1616B	16.0	16.0	125.0	17.0	16.0	3.0	0.26	N123F2-0250-0002-CM
	16 x 16	20.0	22.4	R/LF123F20-1616B	16.0	16.0	125.0	17.0	16.0	4.0	0.25	N123F2-0250-0002-CM
	20 x 20	10.0	29.0	R/LF123F10-2020B	20.0	20.0	125.0	21.0	20.0	3.0	0.35	N123F2-0250-0002-CM
	20 x 20	20.0	22.4	R/LF123F20-2020B	20.0	20.0	125.0	21.0	20.0	4.0	0.36	N123F2-0250-0002-CM
	25 x 25	10.0	29.0	R/LF123F10-2525B	25.0	25.0	150.0	26.0	25.0	3.0	0.72	N123F2-0250-0002-CM
	25 x 25	20.0	22.4	R/LF123F20-2525B	25.0	25.0	150.0	26.0	25.0	4.0	0.67	N123F2-0250-0002-CM
G	16 x 16	10.0	22.4	R/LF123G10-1616B	16.0	16.0	125.0	17.0	16.0	3.5	0.26	N123G2-0300-0003-TF
	16 x 16	20.0	41.0	R/LF123G20-1616B	16.0	16.0	125.0	17.0	16.0	5.0	0.26	N123G2-0300-0003-TF
	20 x 20	10.0	22.4	R/LF123G10-2020B	20.0	20.0	125.0	21.0	20.0	3.5	0.40	N123G2-0300-0003-TF
	20 x 20	20.0	41.0	R/LF123G20-2020B	20.0	20.0	125.0	21.0	20.0	5.0	0.36	N123G2-0300-0003-TF
	25 x 25	10.0	22.4	R/LF123G10-2525B	25.0	25.0	150.0	26.0	25.0	3.5	0.73	N123G2-0300-0003-TF
	25 x 25	20.0	41.0	R/LF123G20-2525B	25.0	25.0	150.0	26.0	25.0	5.0	0.68	N123G2-0300-0003-TF
H	16 x 16	13.0	34.0	R/LF123H13-1616B	16.0	16.0	125.0	17.0	16.0	4.5	0.21	N123H2-0400-0004-TF
	16 x 16	25.0	47.0	R/LF123H25-1616B	16.0	16.0	125.0	17.0	16.0	7.0	0.26	N123H2-0400-0004-TF
	20 x 20	13.0	34.0	R/LF123H13-2020BM	20.0	20.0	125.0	21.0	20.0	4.5	0.41	N123H2-0400-0004-TF
	20 x 20	25.0	47.0	R/LF123H25-2020BM	20.0	20.0	125.0	21.0	20.0	7.0	0.39	N123H2-0400-0004-TF
	25 x 25	13.0	34.0	R/LF123H13-2525BM	25.0	25.0	150.0	26.0	25.0	4.5	0.73	N123H2-0400-0004-TF
	25 x 25	25.0	47.0	R/LF123H25-2525BM	25.0	25.0	150.0	26.0	25.0	7.0	0.68	N123H2-0400-0004-TF
J	20 x 20	13.0	34.0	R/LF123J13-2020BM	20.0	20.0	125.0	21.0	20.0	5.0	0.41	N123J2-0500-0002-CM
	25 x 25	13.0	34.0	R/LF123J13-2525BM	25.0	25.0	150.0	26.0	25.0	5.0	0.73	N123J2-0500-0002-CM
	25 x 25	22.0	30.0	R/LF123J22-2525B	25.0	25.0	150.0	26.0	25.0	6.0	0.70	N123J2-0500-0004-TF
	25 x 25	32.0	57.0	R/LF123J32-2525BM	25.0	25.0	150.0	26.0	25.0	7.5	0.68	N123J2-0500-0002-CM
	32 x 25	13.0	34.0	R/LF123J13-3225BM	25.0	32.0	170.0	26.0	32.0	5.0	1.05	N123J2-0500-0002-CM
	32 x 25	32.0	57.0	R/LF123J32-3225BM	25.0	32.0	170.0	26.0	32.0	7.5	0.97	N123J2-0500-0002-CM
	32 x 32	13.0	34.0	R/LF123J13-3232BM	32.0	32.0	170.0	33.0	32.0	5.0	1.32	N123J2-0500-0002-CM
	32 x 32	32.0	57.0	R/LF123J32-3232BM	32.0	32.0	170.0	33.0	32.0	7.5	1.21	N123J2-0500-0002-CM

SSC = Para corresponder ao SSC na pastilha.

R = versão direita, L = versão esquerda



B4



F2



E1



H36



H35



H18

Ferramenta convencional CoroCut® 1-2 para cortes e canais

Fixação por parafuso

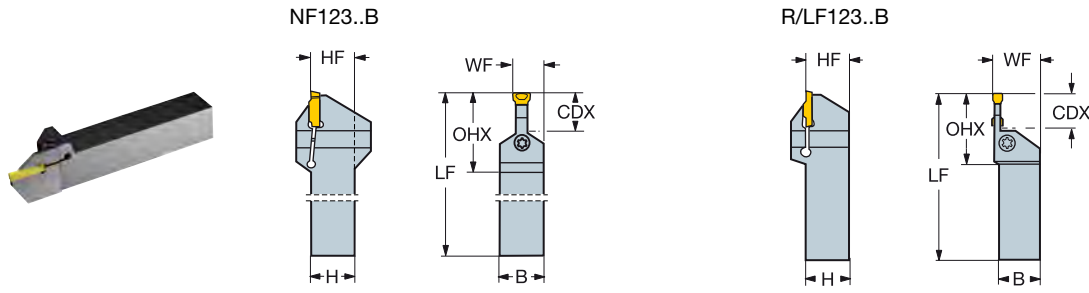

SSC	CZC _{MS}	CDX	OHX	Código para pedido	Dimensões, mm						MIID	
					B	H	LF	WF	HF	NM		KG
K	25 x 25	16.0	39.0	R/LF123K16-2525BM	25.0	25.0	150.0	26.0	25.0	5.5	0.74	N123K2-0600-0004-TF
	25 x 25	32.0	58.0	R/LF123K32-2525BM	25.0	25.0	150.0	26.0	25.0	7.5	0.69	N123K2-0600-0004-TF
	32 x 25	16.0	39.0	R/LF123K16-3225BM	25.0	32.0	170.0	26.0	32.0	5.5	1.03	N123K2-0600-0004-TF
	32 x 25	32.0	58.0	R/LF123K32-3225BM	25.0	32.0	170.0	26.0	32.0	7.5	0.96	N123K2-0600-0004-TF
	32 x 32	16.0	39.0	R/LF123K16-3232BM	32.0	32.0	170.0	33.0	32.0	5.5	1.29	N123K2-0600-0004-TF
	32 x 32	32.0	58.0	R/LF123K32-3232BM	32.0	32.0	170.0	33.0	32.0	7.5	1.21	N123K2-0600-0004-TF
L	25 x 25	16.0	41.0	R/LF123L16-2525BM	25.0	25.0	150.0	26.0	25.0	6.5	0.74	N123L2-0800-0008-TF
	25 x 25	25.0	52.0	R/LF123L25-2525BM	25.0	25.0	150.0	26.0	25.0	7.0	0.74	N123L2-0800-0008-TF
	32 x 25	25.0	52.0	R/LF123L25-3225BM	25.0	32.0	170.0	26.0	32.0	7.0	1.01	N123L2-0800-0008-TF
	32 x 25	32.0	60.0	R/LF123L32-3225BM	25.0	32.0	170.0	26.0	32.0	7.5	0.97	N123L2-0800-0008-TF
	32 x 32	32.0	60.0	R/LF123L32-3232BM	32.0	32.0	170.0	33.0	32.0	7.5	1.20	N123L2-0800-0008-TF
M	32 x 32	32.0	63.9	R/LF123M32-3232B	32.0	32.0	250.0	34.0	32.0	9.0	2.13	N123M1-1100-0008-GM
	40 x 40	32.0	63.9	R/LF123M32-4040B	40.0	40.0	250.0	42.0	40.0	9.0	3.14	N123M1-1100-0008-GM
	40 x 40	50.0	63.9	R/LF123M50-4040B	40.0	40.0	250.0	42.0	40.0	4.5	2.78	N123M1-1100-0008-GM
R	32 x 32	32.0	71.3	R/LF123R32-3232B	32.0	32.0	250.0	34.5	32.0	10.0	2.13	N123R1-1500-0010-GR
	40 x 40	32.0	71.3	R/LF123R32-4040B	40.0	40.0	250.0	42.5	40.0	10.0	3.15	N123R1-1500-0010-GR
	40 x 40	50.0	71.3	R/LF123R50-4040B	40.0	40.0	250.0	42.5	40.0	4.5	2.76	N123R1-1500-0010-GR
M	40 x 40	32.0	63.9	NF123M32-4040B	40.0	40.0	250.0	25.7	40.0	9.0	3.00	N123M1-1100-0008-GM
	40 x 40	32.0	71.3	NF123R32-4040B	40.0	40.0	250.0	27.5	40.0	10.0	3.14	N123R1-1500-0010-GR

SSC = Para corresponder ao SSC na pastilha.

R = versão direita, L = versão esquerda

Componentes			
SSC	CDX	CZC _{MS}	Parafuso
D,E,F	8-20	16 x 16-32 x 25	3212 012-259
G,H	10-25	16 x 16	3212 012-309
G	10-20	20 x 20-32 x 32	3212 012-310
H,J,K,L	13-16	20 x 20-32 x 32	5512 044-01
J	22	25 x 25	3212 012-360
H,J,K,L,M,R	25-32	20 x 20-40 x 40	5512 044-01
M,R	50	40 x 40	5512 046-01

Para a lista completa de componentes, acesse www.sandvik.coromant.com



Ferramenta convencional CoroCut® 1-2 para cortes e canais

Fixação por parafuso

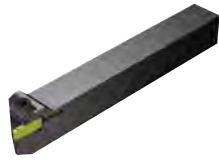

R/LF123..B-S

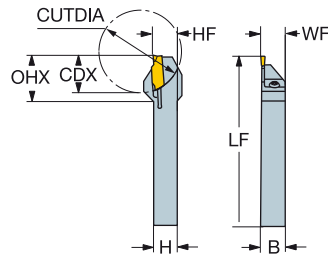

R/LF123..D

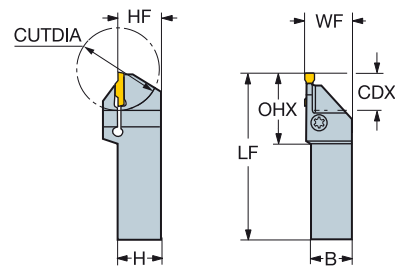

SSC	CZC _{MS}	CDX	OHX	Código para pedido	Dimensões, mm								MIID
					B	H	LF	WF	HF	CUTDIA	NM	KG	
D	16 x 16	8.0	19.6	RF123D08-1616B-S	16.0	16.0	125.0	16.0	16.0	16	2.5	0.26	N123D2-0150-0002-CM
	16 x 16	17.0	28.6	RF123D17-1616B-S	16.0	16.0	125.0	16.0	16.0	34	2.5	0.24	N123D2-0150-0002-CM
	16 x 16	11.0	22.6	RF123E11-1616B-S	16.0	16.0	125.0	16.0	16.0	22	2.5	0.25	N123E2-0200-0002-CM
E	16 x 16	17.0	28.6	R/LF123E17-1616B-S	16.0	16.0	125.0	16.0	16.0	34	2.5	0.24	N123E2-0200-0002-CM
	16 x 16	11.0	22.6	RF123E11-1616B-S	16.0	16.0	125.0	16.0	16.0	22	2.5	0.25	N123E2-0200-0002-CM
F	16 x 16	17.0	28.6	R/LF123F17-1616B-S	16.0	16.0	125.0	16.0	16.0	34	2.5	0.24	N123F2-0250-0002-CM
G	16 x 16	17.0	28.6	R/LF123G17-1616B-S	16.0	16.0	125.0	16.0	16.0	34	3.0	0.24	N123G2-0300-0003-TF
E	20 x 20	17.0	35.5	R/LF123E17-2020D	20.0	20.0	125.0	20.5	20.0	42	4.0	0.40	N123E2-0200-0002-CM
	20 x 20	17.0	22.4	R/LF123F17-2020D	20.0	20.0	125.0	20.5	20.0	42	4.0	0.40	N123F2-0250-0002-CM
	25 x 25	17.0	22.4	R/LF123F17-2525D	25.0	25.0	150.0	25.5	25.0	42	4.0	0.71	N123F2-0250-0002-CM
G	20 x 20	22.0	43.0	R/LF123G22-2020D	20.0	20.0	125.0	20.6	20.0	44	5.0	0.40	N123G2-0300-0003-TF
	25 x 25	22.0	43.0	R/LF123G22-2525D	25.0	25.0	150.0	25.6	25.0	44	5.0	0.69	N123G2-0300-0003-TF
	20 x 20	22.0	44.0	R/LF123H22-2020D	20.0	20.0	125.0	20.6	20.0	52	6.0	0.40	N123H2-0400-0004-TF
H	20 x 20	22.0	44.0	R/LF123H22-2020D	20.0	20.0	125.0	20.6	20.0	52	6.0	0.40	N123H2-0400-0004-TF
					25.0	25.0	150.0	25.6	25.0	52	6.0	0.71	N123H2-0400-0004-TF

SSC = Para corresponder ao SSC na pastilha.

R = versão direita, L = versão esquerda

Componentes		
SSC	CZC _{MS}	Parafuso
D	16 x 16	5513 021-04
E	16 x 16	5513 021-04
E	20 x 20	3212 012-259
F	16 x 16	5513 021-04
F	20 x 20-25 x 25	3212 012-259
G	16 x 16	5513 021-04
G	20 x 20-25 x 25	3212 012-310
H	20 x 20-25 x 25	5512 044-01

Para a lista completa de componentes, acesse www.sandvik.coromant.com



Ferramenta convencional CoroCut® 1-2 QS para cortes e canais

Trava por mecanismo tipo mola

Refrigeração de precisão

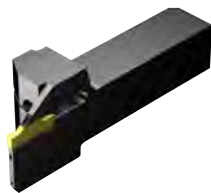

QS-R/LF123..C..E

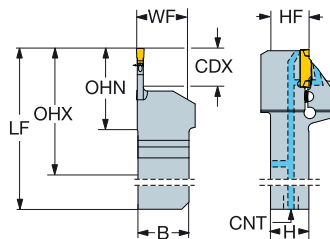

QS-R/LF123..C..F

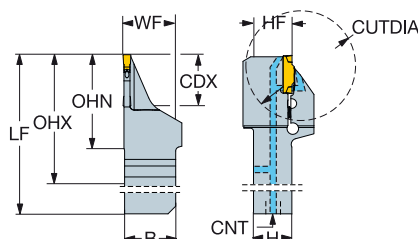

SSC	CZC _{MS}	CDX	OHX	OHN	CNSC	Código para pedido	Dimensões, mm							BAR	KG	MIID
							B	H	LF	WF	HF	CUTDIA	CNT			
E	20 x 20	20.0	62.7	37.7	3	QS-R/LF123E20C2020F	20.0	20.0	106.7	20.5	20.0	40	G 1/8-28	150	0.38	N123E2-0200-0002-CM
	25 x 25	15.0	57.1	32.1	3	QS-R/LF123E15C2525E	25.0	25.0	116.1	25.5	25.0		G 1/8-28	150	0.55	N123E2-0200-0002-CM
F	20 x 20	20.0	62.7	37.7	3	QS-R/LF123F20C2020F	20.0	20.0	106.7	20.5	20.0	40	G 1/8-28	150	0.38	N123F2-0250-0002-CM
	25 x 25	20.0	62.1	37.1	3	QS-R/LF123F20C2525E	25.0	25.0	121.1	25.5	25.0		G 1/8-28	150	0.58	N123F2-0250-0002-CM
G	20 x 20	15.0	57.7	32.7	3	QS-R/LF123G15C2020E	20.0	20.0	101.7	22.6	20.0		G 1/8-28	150	0.37	N123G2-0300-0003-TF
	20 x 20	20.0	62.7	37.7	3	QS-R/LF123G20C2020F	20.0	20.0	106.7	20.5	20.0	40	G 1/8-28	150	0.38	N123G2-0300-0003-TF
	25 x 25	15.0	57.1	32.1	3	QS-R/LF123G15C2525E	25.0	25.0	116.1	25.5	25.0		G 1/8-28	150	0.56	N123G2-0300-0003-TF
H	25 x 25	20.0	62.1	37.1	3	QS-R/LF123G20C2525E	25.0	25.0	121.1	25.5	25.0		G 1/8-28	150	0.58	N123G2-0300-0003-TF
	20 x 20	20.0	62.7	37.7	3	QS-R/LF123H20C2020E	20.0	20.0	106.7	24.0	20.0		G 1/8-28	150	0.39	N123H2-0400-0004-TF
	20 x 20	25.0	67.7	42.7	3	QS-R/LF123H25C2020F	20.0	20.0	111.7	20.5	20.0	50	G 1/8-28	150	0.40	N123H2-0400-0004-TF
J	25 x 25	20.0	61.8	36.8	3	QS-R/LF123H20C2525E	25.0	25.0	120.8	25.5	25.0		G 1/8-28	150	0.59	N123H2-0400-0004-TF
	25 x 25	25.0	66.8	41.8	3	QS-R/LF123H25C2525E	25.0	25.0	125.8	25.5	25.0		G 1/8-28	150	0.60	N123H2-0400-0004-TF
	20 x 20	20.0	62.7	37.7	3	QS-R/LF123J20C2020E	20.0	20.0	106.7	24.5	20.0		G 1/8-28	150	0.40	N123J2-0500-0004-TF
K	25 x 25	25.0	66.8	41.8	3	QS-R/LF123J25C2525E	25.0	25.0	125.8	25.5	25.0		G 1/8-28	150	0.61	N123J2-0500-0004-TF
	25 x 25	25.0	66.8	41.8	3	QS-R/LF123K25C2525E	25.0	25.0	125.8	25.5	25.0		G 1/8-28	150	0.62	N123K2-0600-0004-TF
L	25 x 25	32.0	73.2	48.2	3	QS-R/LF123L32C2525E	25.0	25.0	132.2	25.5	25.0		G 1/8-28	150	0.65	N123L2-0800-0008-TF
M	25 x 25	32.0	74.2	49.2	3	QS-R/LF123M32C2525E	25.0	25.0	133.2	26.0	25.0		G 1/8-28	150	0.68	N123M2-1000-0008-GM

SSC = Para corresponder ao SSC na pastilha.

R = versão direita, L = versão esquerda

Componentes	
Plugue	Plugue
3214 013-01	3214 012-01

Para a lista completa de componentes, acesse www.sandvik.coromant.com



Lâmina CoroCut® 1-2 para cortes

Trava por mecanismo tipo mola

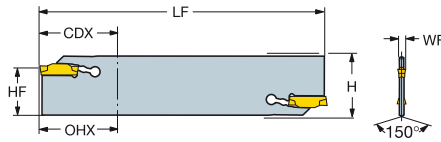

Lâmina de corte com dupla extremidade

SSC	CZC _{MS}	CDX	OHX	Código para pedido	Dimensões, mm					MIID
					H	LF	WF	HF	KG	
F	21	30.0	30.0	N123F30-21A2	25.9	110.0	2.3	21.4	0.05	N123F2-0250-0002-CM
	25	55.0	55.0	N123F55-25A2	31.9	150.0	2.3	25.0	0.09	N123F2-0250-0002-CM
G	21	30.0	30.0	N123G30-21A2	25.9	110.0	2.7	21.4	0.06	N123G2-0300-0003-TF
	25	55.0	55.0	N123G55-25A2	31.9	150.0	2.3	25.0	0.10	N123G2-0300-0003-TF
H	25	55.0	55.0	N123H55-25A2	31.9	150.0	3.7	25.0	0.13	N123H2-0400-0004-TF
J	25	55.0	55.0	N123J55-25A2	31.9	150.0	4.8	25.0	0.16	N123J2-0500-0002-CM
K	25	55.0	55.0	N123K55-25A2	31.9	150.0	5.8	25.0	0.18	N123K2-0600-0004-CR

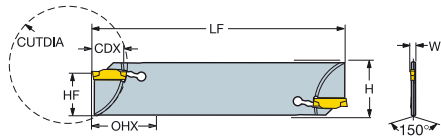

Lâmina de corte com dupla extremidade e reforço curvo

SSC	CZC _{MS}	CDX	OHX	Código para pedido	Dimensões, mm					MIID	
					H	LF	WF	HF	CUTDIA		KG
D	21	15.0	30.0	N123D15-21A2	25.9	110.0	1.3	21.4	30	0.05	N123D2-0150-0002-CM
E	21	15.0	30.0	N123E15-21A2	25.9	110.0	1.8	21.4	30	0.05	N123E2-0200-0002-CM

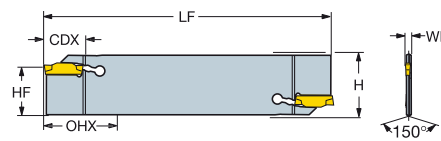

Lâmina de corte com dupla extremidade e reforço linear

SSC	CZC _{MS}	CDX	OHX	Código para pedido	Dimensões, mm					MIID
					H	LF	WF	HF	KG	
D	25	15.0	55.0	N123D15-25A2	31.9	150.0	1.3	25.0	0.08	N123D2-0150-0002-CM
E	25	20.0	55.0	N123E20-25A2	31.9	150.0	1.8	25.0	0.07	N123E2-0200-0002-CM

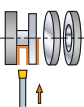

SSC = Para corresponder ao SSC na pastilha.
Para componentes, visite www.sandvik.coromant.com

N = neutra



B4



F2



E1



ISO 13399



H36



H35



H18



Lâmina CoroCut® 1-2 para cortes

Fixação por parafuso

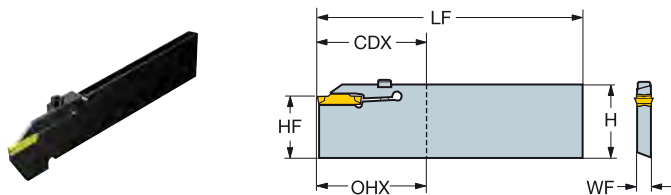

Lâmina de corte com aresta única

		Dimensões, mm											
SSC	CZC _{MS}	CDX	OHX	OHN	Código para pedido	H	LF	WF	HF	NM	KG	MIID	
M	45R	100.0	100.0	73.0	R/LF123M100-45B1	52.5	250.0	9.6	45.0	4.5	0.90	N123M1-1100-0008-GM	
	93R	120.0	120.0	83.0	R/LF123M120-93B1	101.6	300.0	9.6	93.5	4.5	2.34	N123M1-1100-0008-GM	
R	93R	120.0	120.0	83.0	R/LF123R120-93B1	101.6	300.0	13.1	93.5	4.5	2.92	N123R1-1500-0010-GR	

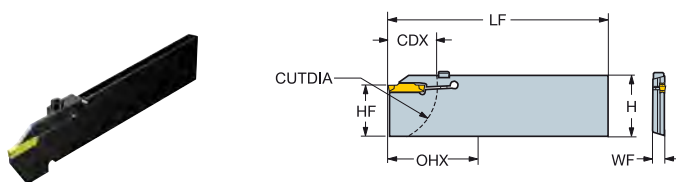

Lâmina de corte com extremidade única e reforço curvo

		Dimensões, mm											
SSC	CZC _{MS}	CDX	OHX	Código para pedido	H	LF	WF	HF	CUTDIA	NM	KG	MIID	
E	21R	20.0	45.0	R/LF123E20-21B1	25.9	110.0	1.8	21.4	40	3.3	0.17	N123E2-0200-0002-CM	
	25R	25.0	45.0	R/LF123E25-25B1	31.9	150.0	1.8	25.0	50	3.3	0.27	N123E2-0200-0002-CM	
F	21R	25.0	45.0	R/LF123F25-21B1	25.9	110.0	2.3	21.4	50	3.3	0.17	N123F2-0250-0002-CM	
	25R	25.0	45.0	R/LF123F25-25B1	31.9	150.0	2.3	25.0	50	3.6	0.24	N123F2-0250-0002-CM	
G	21R	30.0	51.0	R/LF123G30-21B1	25.9	110.0	2.7	21.4	60	4.5	0.17	N123G2-0300-0003-TF	
	25R	25.0	45.0	R/LF123G25-25B1	31.9	150.0	2.7	25.0	50	4.5	0.28	N123G2-0300-0003-TF	
	25R	33.0	54.0	R/LF123G33-25B1	31.9	150.0	2.7	25.0	66	4.5	0.27	N123G2-0300-0003-TF	
H	25R	32.0	51.0	R/LF123H32-25B1	31.9	150.0	3.7	25.0	64	4.9	0.28	N123H2-0400-0004-TF	

SSC = Para corresponder ao SSC na pastilha.

R = versão direita, L = versão esquerda

		Componentes
SSC	CZC _{MS}	Parafuso de fixação
E	21L-25R	3212 012-259
F	21L-25R	3212 012-259
G	21L-25R	3212 012-259
H	25L-25R	3212 012-259
M	45L-93R	5512 046-01
R	93L-93R	3212 012-311

Para a lista completa de componentes, acesse www.sandvik.coromant.com



Ferramenta convencional CoroCut® 1-2 para usinagem de canais rasos

Fixação por parafuso

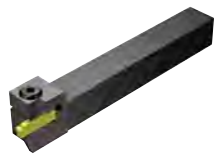

R/LF123..C

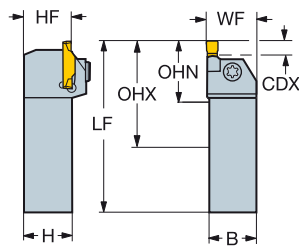

R/LG123..C

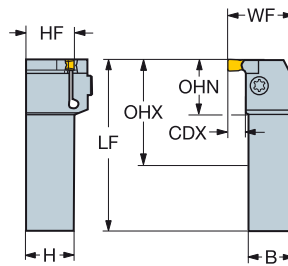

SSC	CZC _{MS}	CDX	CDX ₁	CDX ₂	OHX	OHN	Código para pedido	Dimensões, mm						NM	KG	MIID
								B	H	LF	WF	HF				
G	16 x 16	7.0	3.5	43.0	27.0	R/LF123G07-1616C	16.0	16.0	125.0	17.0	16.0	3.5	0.27	N123G2-0300-0003-TF		
	20 x 20	7.0	3.5	47.0	27.0	R/LF123G07-2020C	20.0	20.0	125.0	21.0	20.0	3.5	0.41	N123G2-0300-0003-TF		
	25 x 25	7.0	3.5	52.0	27.0	R/LF123G07-2525C	25.0	25.0	150.0	26.0	25.0	3.5	0.74	N123G2-0300-0003-TF		
K	20 x 20	8.0	4.5	50.0	30.0	R/LF123K08-2020C	20.0	20.0	125.0	21.0	20.0	4.5	0.42	N123K2-0600-0004-TF		
	25 x 25	8.0	4.5	55.0	30.0	R/LF123K08-2525CM	25.0	25.0	150.0	26.0	25.0	4.5	0.75	N123K2-0600-0004-TF		
G	16 x 16	7.0	3.5	39.5	23.5	R/LG123G07-1616C	16.0	16.0	125.0	25.0	16.0	3.5	0.30	N123G2-0300-0003-TF		
	20 x 20	7.0	3.5	43.5	23.5	R/LG123G07-2020C	20.0	20.0	125.0	29.0	20.0	3.5	0.44	N123G2-0300-0003-TF		
	25 x 25	7.0	3.5	48.5	23.5	R/LG123G07-2525C	25.0	25.0	150.0	34.0	25.0	3.5	0.78	N123G2-0300-0003-TF		
	20 x 20	8.0		28.7		R/LG123K08-2020C	20.0	20.0	125.0	30.0	20.0	4.5	0.45	N123K2-0600-0004-TF		
	25 x 25	8.0	4.5	54.0	29.0	R/LG123K08-2525CM	25.0	25.0	150.0	34.0	25.0	4.5	0.80	N123K2-0600-0004-TF		

SSC = Para corresponder ao SSC na pastilha.

R = versão direita, L = versão esquerda

Suportes para usinagem de canais rasos podem indexar vários tamanhos de pastilhas. Suporte com SSC G pode indexar pastilhas E, F e G. Suportes com SSC K podem indexar pastilhas SSC H, J e K.

Diâmetro do primeiro corte durante a usinagem de canais frontais

Tamanho do assento do suporte	Tamanho do assento da pastilha	Diâmetro do primeiro corte mín. - máx. mm	Máx. profundidade de corte mm	Diâmetros do primeiro corte 123-GM, -TF, -CM, -RM, -TM
G	E	100 - ∞	3.5	
	F	83 - ∞	3.5	
	G	57 - ∞	3.5	
K	H	46 - ∞	4.5	
	J	46 - ∞	4.5	
	K	46 - ∞	4.5	

Componentes	
Código para pedido	Parafuso
R/LF123G07-1616C	3212 012-309
R/LG123G07-1616C	3212 012-310
R/LF123G07-2020C	3212 012-310
R/LG123G07-2020C	3212 012-310
R/LF123G07-2525C	3212 012-310
R/LG123G07-2525C	3212 012-310
R/LF123K08-2020C	3212 012-360
R/LG123K08-2020C	3212 012-360
R/LF123K08-2525CM	5512 044-01
R/LG123K08-2525CM	5512 044-01

Para a lista completa de componentes, acesse www.sandvik.coromant.com



B4



F2



E1



H36



H35



H18



Cabeça CoroCut® 1-2 para canais

Fixação por parafuso

CoroTurn® SL - Refrigeração interna

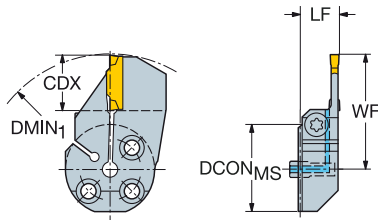

C

SSC	CZC _{MS}	CDX	DMIN ₁	OHX	CNSC	Código para pedido	Dimensões, mm						MIID
							DCON _{MS}	LF	WF	BAR	NM	KG	
D	25	12.0	145.0	13.3	1	570-25R/L123D12B	25	14.0	30.9	10	2.0	0.08	N123D2-0150-0002-CM
	32	12.0	145.0	13.3	1	570-32R/L123D12B	32	14.0	34.4	10	2.0	0.11	N123D2-0150-0002-CM
E	25	15.0	139.0	13.0	1	570-25R/L123E15B	25	14.0	33.9	10	2.0	0.08	N123E2-0200- GM
	32	15.0	139.0	13.0	1	570-32R/L123E15B	32	14.0	37.4	10	2.0	0.11	N123E2-0200- GM
F	25	15.0	143.0	12.8	1	570-25R/L123F15B	25	14.0	33.9	10	2.0	0.08	N123F2-0250- GM
	32	15.0	139.0	12.8	1	570-32R/L123F15B	32	14.0	37.4	10	2.0	0.12	N123F2-0250- GM
G	25	18.0	147.0	12.5	1	570-25R/L123G18B	25	14.0	37.6	10	3.0	0.09	N123G2-0300- GM
	32	18.0	147.0	12.5	1	570-32R/L123G18B	32	14.0	41.1	10	3.0	0.13	N123G2-0300- GM
	40	18.0	147.0	12.5	1	570-40R/L123G18B	40	14.0	45.1	10	3.0	0.17	N123G2-0300- GM
H	32	23.0	95.0	16.0	1	570-32R/L123H23B	32	18.0	46.1	10	3.0	0.16	N123H2-0400- GM
	40	23.0	95.0	16.0	1	570-40R/L123H23B	40	18.0	50.1	10	3.0	0.09	N123H2-0400- GM
J	32	18.0	95.0	15.5	1	570-32R/L123J18B	32	18.0	41.1	10	4.0	0.14	N123J2-0500- GM
	40	18.0	95.0	15.5	1	570-40R/L123J18B	40	18.0	45.1	10	3.0	0.21	N123J2-0500- GM
K	40	18.0	95.0	15.0	1	570-40R/L123K18B	40	18.0	45.1	10	4.0	0.21	N123K2-0600-GM

SSC = Para corresponder ao SSC na pastilha.

R = versão direita, L = versão esquerda

D

SSC	CZC _{MS}	Componentes	
		Parafuso	Tubo para refrigeração
D	25	3212 012-259	5691 041-01
D	32	3212 012-260	5691 041-01
E	25	3212 012-259	5691 041-01
E	32	3212 012-260	5691 041-01
F	25	3212 012-259	5691 041-01
F	32	3212 012-260	5691 041-01
G	25	3212 012-309	5691 041-01
G	32	3212 012-310	5691 041-01
G	40	3212 012-311	5691 041-01
H	32	3212 012-310	5691 041-02
H	40	3212 012-311	5691 041-02
J	32	3212 012-310	5691 041-02
J	40	3212 012-311	5691 041-02
K	40	3212 012-311	5691 041-02

Para a lista completa de componentes, acesse www.sandvik.coromant.com

F

G

H



Cabeça CoroCut® 1-2 para canais

Fixação por parafuso

CoroTurn® SL - Refrigeração interna

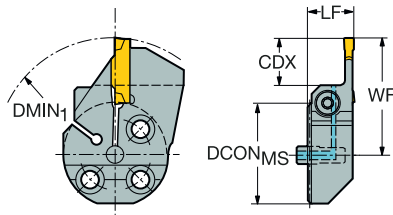

SSC	CZC _{MS}	CDX	DMIN ₁	OHX	CN5C	Código para pedido	Dimensões, mm						MIID
							DCON _{MS}	LF	WF	BAR	NM	KG	
G	25	13.0	147.0	12.5	1	570-25R/L123G13C	25	14.0	32.6	10	3.0	0.08	N123G2-0300-0003-TF
	32	13.0	147.0	12.5	1	570-32R/L123G13C	32	14.0	36.1	10	2.5	0.11	N123G2-0300-0003-TF
	40	12.0	147.0	12.5	1	570-40R/L123G12C	40	14.0	39.1	10	2.0	0.16	N123G2-0300-0003-TF
J	32	18.0	88.0	15.5	1	570-32R/L123J18C	32	14.0	41.1	10	3.0	0.14	N123J2-0500-0002-CM
K	40	17.0	92.0	15.0	1	570-40R/L123K17C	40	18.0	44.1	10	2.5	0.21	N123K2-0600-0004-TF

SSC = Para corresponder ao SSC na pastilha.

R = versão direita, L = versão esquerda

Componentes				
SSC	CZC _{MS}	Parafuso	Olhal	Bucha-guia
G	25	3212 012-309		
G	32	3212 012-310		
G	40	3212 012-311		
J	32	3212 012-310		
K	40	3212 012-311		
M	70	3212 010-314	5691 026-23	5552 058-04
R	70	3212 010-365	5691 026-23	5552 058-04

Para a lista completa de componentes, acesse www.sandvik.coromant.com



Unidade de corte CoroCut® 1-2 para canais frontais

Trava por mecanismo tipo mola

Coromant Capto® - Refrigeração de precisão

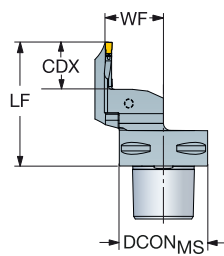
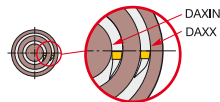

Curvatura B

SSC	CZC _{MS}	CDX	DAXIN	DAXX	CNSC	Código para pedido	Dimensões, mm					MID
							DCON _{MS}	LF	WF	BAR	KG	
G	C4	20.0	42.0	60.0	3	C4-R/LF123G20CE-042B	40	65.0	27.0	150	0.56	N123G2-0300-0003-TF
	C4	20.0	54.0	75.0	3	C4-R/LF123G20CE-054B	40	65.0	27.0	150	0.55	N123G2-0300-0003-TF
	C4	20.0	67.0	100.0	3	C4-R/LF123G20CE-067B	40	65.0	27.0	150	0.55	N123G2-0300-0003-TF
	C4	20.0	90.0	160.0	3	C4-R/LF123G20CE-090B	40	65.0	27.0	150	0.55	N123G2-0300-0003-TF
H	C4	25.0	64.0	100.0	3	C4-R/LF123H25CE-064B	40	70.0	27.0	150	0.56	N123H2-0400-0004-TF
	C4	25.0	92.0	140.0	3	C4-R/LF123H25CE-092B	40	70.0	27.0	150	0.56	N123H2-0400-0004-TF
	C4	25.0	132.0	230.0	3	C4-R/LF123H25CE-132B	40	70.0	27.0	150	0.55	N123H2-0400-0004-TF
	C5	25.0	64.0	100.0	3	C5-R/LF123H25CE-064B	50	70.0	33.0	150	0.79	N123H2-0400-0004-TF
	C5	25.0	92.0	140.0	3	C5-R/LF123H25CE-092B	50	70.0	33.0	150	0.79	N123H2-0400-0004-TF
	C5	25.0	132.0	230.0	3	C5-R/LF123H25CE-132B	50	70.0	33.0	150	0.78	N123H2-0400-0004-TF
	C5	25.0	220.0	500.0	3	C5-R/LF123H25CE-220B	50	70.0	33.0	150	0.78	N123H2-0400-0004-TF
	C5	25.0	300.0	2000.0	3	C5-R/LF123H25CE-300B	50	70.0	33.0	150	0.78	N123H2-0400-0004-TF
	C6	25.0	64.0	100.0	3	C6-R/LF123H25CE-064B	63	70.0	39.0	150	1.17	N123H2-0400-0004-TF
	C6	25.0	92.0	140.0	3	C6-R/LF123H25CE-092B	63	70.0	39.0	150	1.17	N123H2-0400-0004-TF
	C6	25.0	132.0	230.0	3	C6-R/LF123H25CE-132B	63	70.0	39.0	150	1.16	N123H2-0400-0004-TF
	C6	25.0	220.0	500.0	3	C6-R/LF123H25CE-220B	63	70.0	39.0	150	1.16	N123H2-0400-0004-TF
C6	25.0	300.0	2000.0	3	C6-R/LF123H25CE-300B	63	70.0	39.0	150	1.15	N123H2-0400-0004-TF	
J	C4	20.0	40.0	70.0	3	C4-R/LF123J20CE-040B	40	65.0	27.0	150	0.57	N123J2-0500-0004-TF
	C4	25.0	60.0	95.0	3	C4-R/LF123J25CE-060B	40	70.0	27.0	150	0.57	N123J2-0500-0004-TF
	C4	25.0	85.0	130.0	3	C4-R/LF123J25CE-085B	40	70.0	27.0	150	0.57	N123J2-0500-0004-TF
	C4	25.0	120.0	180.0	3	C4-R/LF123J25CE-120B	40	70.0	27.0	150	0.57	N123J2-0500-0004-TF
	C5	20.0	40.0	70.0	3	C5-R/LF123J20CE-040B	50	65.0	33.0	150	0.80	N123J2-0500-0004-TF
	C5	25.0	60.0	95.0	3	C5-R/LF123J25CE-060B	50	70.0	33.0	150	0.64	N123J2-0500-0004-TF
	C5	25.0	85.0	130.0	3	C5-R/LF123J25CE-085B	50	70.0	33.0	150	0.80	N123J2-0500-0004-TF
	C5	25.0	120.0	180.0	3	C5-R/LF123J25CE-120B	50	70.0	33.0	150	0.63	N123J2-0500-0004-TF
	C5	25.0	175.0	500.0	3	C5-R/LF123J25CE-175B	50	70.0	33.0	150	0.75	N123J2-0500-0004-TF
	C6	20.0	40.0	70.0	3	C6-R/LF123J20CE-040B	63	65.0	39.0	150	1.22	N123J2-0500-0004-TF
	C6	25.0	60.0	95.0	3	C6-R/LF123J25CE-060B	63	70.0	39.0	150	1.22	N123J2-0500-0004-TF
	C6	25.0	85.0	130.0	3	C6-R/LF123J25CE-085B	63	70.0	39.0	150	1.22	N123J2-0500-0004-TF
K	C6	25.0	120.0	180.0	3	C6-R/LF123J25CE-120B	63	70.0	39.0	150	1.21	N123J2-0500-0004-TF
	C6	25.0	175.0	500.0	3	C6-R/LF123J25CE-175B	63	70.0	39.0	150	1.17	N123J2-0500-0004-TF
	C5	20.0	40.0	70.0	3	C5-R/LF123K20CE-040B	50	65.0	33.0	150	0.64	N123K2-0600-0004-TF
	C5	25.0	58.0	100.0	3	C5-R/LF123K25CE-058B	50	70.0	33.0	150	0.81	N123K2-0600-0004-TF
	C5	25.0	88.0	180.0	3	C5-R/LF123K25CE-088B	50	70.0	33.0	150	0.63	N123K2-0600-0004-TF
	C5	25.0	168.0	400.0	3	C5-R/LF123K25CE-168B	50	70.0	33.0	150	0.76	N123K2-0600-0004-TF
	C5	25.0	220.0	1000.0	3	C5-R/LF123K25CE-220B	50	70.0	33.0	150	0.63	N123K2-0600-0004-TF
	C6	20.0	40.0	70.0	3	C6-R/LF123K20CE-040B	63	65.0	39.0	150	1.03	N123K2-0600-0004-TF
	C6	25.0	58.0	100.0	3	C6-R/LF123K25CE-058B	63	70.0	39.0	150	1.23	N123K2-0600-0004-TF
	C6	25.0	88.0	180.0	3	C6-R/LF123K25CE-088B	63	70.0	39.0	150	1.18	N123K2-0600-0004-TF
	C6	25.0	168.0	400.0	3	C6-R/LF123K25CE-168B	63	70.0	39.0	150	1.18	N123K2-0600-0004-TF
	C6	25.0	220.0	1000.0	3	C6-R/LF123K25CE-220B	63	70.0	39.0	150	1.18	N123K2-0600-0004-TF
L	C6	25.0	50.0	80.0	3	C6-R/LF123L25CE-050B	63	70.0	39.0	150	1.03	N123L2-0800-0008-TF
	C6	28.0	75.0	150.0	3	C6-R/LF123L28CE-075B	63	73.0	39.0	150	1.20	N123L2-0800-0008-TF
	C6	28.0	140.0	400.0	3	C6-R/LF123L28CE-140B	63	73.0	39.0	150	1.18	N123L2-0800-0008-TF

SSC = Para corresponder ao SSC na pastilha.

R = versão direita, L = versão esquerda

Para componentes, visite www.sandvik.coromant.com



Ferramenta convencional CoroCut® 1-2 para canais frontais

Fixação por parafuso

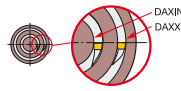

R/LF123..B..B

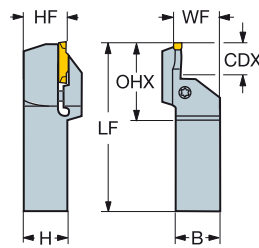

R/LG123..BM

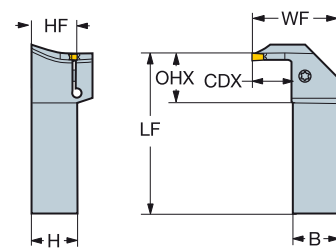

Curvatura B

SSC	CZC _{MS}	CDX	DAXIN	DAXX	OHX	Código para pedido	Dimensões, mm							MIID	
							B	H	LPR	LF	WF	HF	NM		KG
G	20 x 20	12.0	34.0	44.0	32.0	R/LF123G12-2020B-034B	20.0	20.0	125.0	21.0	20.0	2.1	0.41	N123G2-0300-0003-TF	
	20 x 20	12.0	38.0	48.0	32.0	R/LF123G12-2020B-038B	20.0	20.0	125.0	21.0	20.0	2.1	0.40	N123G2-0300-0003-TF	
	20 x 20	13.0	42.0	60.0	33.0	R/LF123G13-2020B-042B	20.0	20.0	125.0	21.0	20.0	2.2	0.40	N123G2-0300-0003-TF	
	20 x 20	13.0	54.0	75.0	33.0	R/LF123G13-2020B-054B	20.0	20.0	125.0	21.0	20.0	2.3	0.40	N123G2-0300-0003-TF	
	20 x 20	13.0	67.0	100.0	33.0	R/LF123G13-2020B-067B	20.0	20.0	125.0	21.0	20.0	2.6	0.40	N123G2-0300-0003-TF	
	20 x 20	13.0	90.0	160.0	33.0	R/LF123G13-2020B-090B	20.0	20.0	125.0	21.0	20.0	2.9	0.40	N123G2-0300-0003-TF	
	20 x 20	13.0	130.0	300.0	33.0	R/LF123G13-2020B-130B	20.0	20.0	125.0	21.0	20.0	3.1	0.40	N123G2-0300-0003-TF	
	25 x 25	12.0	34.0	44.0	32.0	R/LF123G12-2525B-034B	25.0	25.0	150.0	26.0	25.0	2.1	0.73	N123G2-0300-0003-TF	
	25 x 25	12.0	38.0	48.0	32.0	R/LF123G12-2525B-038B	25.0	25.0	150.0	26.0	25.0	2.1	0.73	N123G2-0300-0003-TF	
	H	20 x 20	13.0	40.0	60.0	34.0	R/LF123H13-2020B-040BM	20.0	20.0	125.0	21.0	20.0	2.8	0.41	N123H2-0400-0004-TF
20 x 20		13.0	52.0	72.0	34.0	R/LF123H13-2020B-052BM	20.0	20.0	125.0	21.0	20.0	3.0	0.41	N123H2-0400-0004-TF	
20 x 20		13.0	64.0	100.0	34.0	R/LF123H13-2020B-064BM	20.0	20.0	125.0	21.0	20.0	3.2	0.41	N123H2-0400-0004-TF	
20 x 20		13.0	92.0	140.0	34.0	R/LF123H13-2020B-092BM	20.0	20.0	125.0	21.0	20.0	3.7	0.41	N123H2-0400-0004-TF	
20 x 20		13.0	132.0	230.0	34.0	R/LF123H13-2020B-132BM	20.0	20.0	125.0	21.0	20.0	4.0	0.41	N123H2-0400-0004-TF	
20 x 20		13.0	220.0	500.0	34.0	R/LF123H13-2020B-220BM	20.0	20.0	125.0	21.0	20.0	4.3	0.41	N123H2-0400-0004-TF	
25 x 25		13.0	40.0	60.0	34.0	R/LF123H13-2525B-040BM	25.0	25.0	150.0	26.0	25.0	2.8	0.74	N123H2-0400-0004-TF	
25 x 25		13.0	52.0	72.0	34.0	R/LF123H13-2525B-052BM	25.0	25.0	150.0	26.0	25.0	3.0	0.74	N123H2-0400-0004-TF	
25 x 25		13.0	64.0	100.0	34.0	R/LF123H13-2525B-064BM	25.0	25.0	150.0	26.0	25.0	3.2	0.73	N123H2-0400-0004-TF	
25 x 25		13.0	92.0	140.0	34.0	R/LF123H13-2525B-092BM	25.0	25.0	150.0	26.0	25.0	3.7	0.73	N123H2-0400-0004-TF	
J	25 x 25	13.0	132.0	230.0	34.0	R/LF123H13-2525B-132BM	25.0	25.0	150.0	26.0	25.0	4.0	0.73	N123H2-0400-0004-TF	
	25 x 25	13.0	220.0	500.0	34.0	R/LF123H13-2525B-220BM	25.0	25.0	150.0	26.0	25.0	4.3	0.73	N123H2-0400-0004-TF	
	25 x 25	13.0	300.0	1100.0	34.0	R/LF123H13-2525B-300BM	25.0	25.0	150.0	26.0	25.0	4.3	0.73	N123H2-0400-0004-TF	
	25 x 25	13.0	40.0	70.0	34.0	R/LF123J13-2525B-040BM	25.0	25.0	150.0	26.0	25.0	2.8	0.73	N123J2-0500-0004-TF	
	25 x 25	13.0	60.0	95.0	34.0	R/LF123J13-2525B-060BM	25.0	25.0	150.0	26.0	25.0	3.2	0.73	N123J2-0500-0004-TF	
	25 x 25	13.0	85.0	130.0	34.0	R/LF123J13-2525B-085BM	25.0	25.0	150.0	26.0	25.0	3.6	0.74	N123J2-0500-0004-TF	
	25 x 25	13.0	120.0	180.0	34.0	R/LF123J13-2525B-120BM	25.0	25.0	150.0	26.0	25.0	4.0	0.74	N123J2-0500-0004-TF	
	25 x 25	13.0	175.0	500.0	34.0	R/LF123J13-2525B-175BM	25.0	25.0	150.0	26.0	25.0	4.0	0.73	N123J2-0500-0004-TF	
	K	25 x 25	13.0	40.0	70.0	35.0	R/LF123K13-2525B-040BM	25.0	25.0	150.0	26.0	25.0	3.2	0.75	N123K2-0600-0004-TF
		25 x 25	13.0	58.0	100.0	35.0	R/LF123K13-2525B-058BM	25.0	25.0	150.0	26.0	25.0	3.5	0.73	N123K2-0600-0004-TF
25 x 25		13.0	88.0	180.0	35.0	R/LF123K13-2525B-088BM	25.0	25.0	150.0	26.0	25.0	4.1	0.74	N123K2-0600-0004-TF	
25 x 25		13.0	168.0	400.0	35.0	R/LF123K13-2525B-168BM	25.0	25.0	150.0	26.0	25.0	4.5	0.73	N123K2-0600-0004-TF	
L		25 x 25	15.0	75.0	150.0	39.0	R/LF123L15-2525B-075BM	25.0	25.0	150.0	26.0	25.0	4.6	0.72	N123L2-0800-0008-TF
	25 x 25	15.0	140.0	400.0	39.0	R/LF123L15-2525B-140BM	25.0	25.0	150.0	26.0	25.0	5.3	0.72	N123L2-0800-0008-TF	
	25 x 25	25.0	50.0	80.0	55.0	R/LF123L25-2525B-050BM	25.0	25.0	150.0	26.0	25.0	4.7	0.74	N123L2-0800-0008-TF	
	25 x 25	28.0	75.0	150.0	56.0	R/LF123L28-2525B-075BM	25.0	25.0	150.0	26.0	25.0	5.8	0.73	N123L2-0800-0008-TF	
	25 x 25	28.0	140.0	400.0	56.0	R/LF123L28-2525B-140BM	25.0	25.0	150.0	26.0	25.0	6.7	0.73	N123L2-0800-0008-TF	
H	25 x 25	13.0	40.0	60.0	23.9	R/LG123H13-2525B-040BM	25.0	25.0	160.5	150.0	40.0	2.8	0.85	N123H2-0400-0004-TF	
	25 x 25	13.0	52.0	72.0	23.9	R/LG123H13-2525B-052BM	25.0	25.0	162.0	150.0	40.0	3.0	0.85	N123H2-0400-0004-TF	
	25 x 25	13.0	64.0	100.0	23.9	R/LG123H13-2525B-064BM	25.0	25.0	158.2	150.0	40.0	3.2	0.82	N123H2-0400-0004-TF	
	25 x 25	13.0	92.0	140.0	23.9	R/LG123H13-2525B-092BM	25.0	25.0	156.6	150.0	40.0	3.7	0.83	N123H2-0400-0004-TF	
	25 x 25	13.0	132.0	230.0	23.9	R/LG123H13-2525B-132BM	25.0	25.0	154.5	150.0	40.0	4.0	0.82	N123H2-0400-0004-TF	
	25 x 25	13.0	220.0	500.0	23.9	R/LG123H13-2525B-220BM	25.0	25.0	153.0	150.0	40.0	4.3	0.82	N123H2-0400-0004-TF	
	25 x 25	13.0	300.0	1100.0	23.9	R/LG123H13-2525B-300BM	25.0	25.0	162.3	150.0	40.0	4.3	0.82	N123H2-0400-0004-TF	
	25 x 25	20.0	168.0	400.0	27.7	RG123K20-2525B-168BM	25.0	25.0	154.3	150.0	47.0	2.5	0.84	N123K2-0600-0004-TF	
	K	25 x 25	20.0	50.0	80.0	37.4	R/LG123L20-2525B-050BM	25.0	25.0	157.9	150.0	47.0	2.5	0.90	N123L2-0800-0008-TF
		25 x 25	20.0	75.0	150.0	37.4	R/LG123L20-2525B-075BM	25.0	25.0	151.2	150.0	47.0	2.5	0.90	N123L2-0800-0008-TF
25 x 25		20.0	140.0	400.0	37.4	R/LG123L20-2525B-140BM	25.0	25.0	152.2	150.0	47.0	2.5	0.90	N123L2-0800-0008-TF	

SSC = Para corresponder ao SSC na pastilha.

R = versão direita, L = versão esquerda

Componentes		
SSC	CZC _{MS}	Parafuso
G	20 x 20-25 x 25	3212 012-310
H	20 x 20-25 x 25	5512 044-01
J	25 x 25	5512 044-01
K	25 x 25-32 x 25	5512 044-01
L	25 x 25-32 x 25	5512 044-01

Para a lista completa de componentes, acesse www.sandvik.coromant.com



Ferramenta convencional CoroCut® 1-2 QS para canais frontais

Trava por mecanismo tipo mola

Refrigeração de precisão

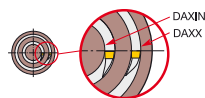
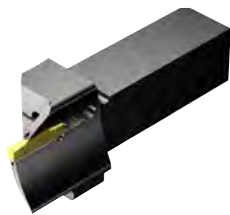

QS-R/LF123..C..E..-B

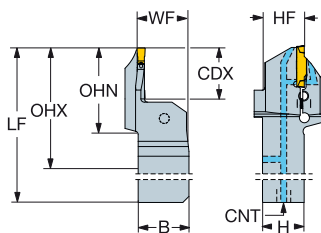

QS-R/LG123..C..E..B

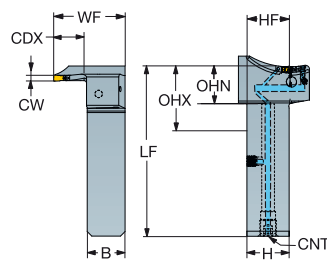

Curvatura B

SSC	CZC _{MS}	CDX	DAXIN	DAXX	OHX	OHN	CNSC	Código para pedido	Dimensões, mm								MID
									B	H	LF	WF	HF	CNT	BAR	KG	
G	20 x 20	14.0	34.0	44.0	51.9	31.9	3	QS-R/LF123G14C2020E-034B	20.0	20.0	100.9	20.5	20.0	G 1/8-28	150	0.39	N123G2-0300-0003-TF
	20 x 20	14.0	38.0	48.0	51.9	31.9	3	QS-R/LF123G14C2020E-038B	20.0	20.0	100.9	20.5	20.0	G 1/8-28	150	0.29	N123G2-0300-0003-TF
	20 x 20	14.0	42.0	60.0	51.9	31.9	3	QS-R/LF123G14C2020E-042B	20.0	20.0	100.9	20.5	20.0	G 1/8-28	150	0.38	N123G2-0300-0003-TF
	20 x 20	14.0	54.0	75.0	51.9	31.9	3	QS-R/LF123G14C2020E-054B	20.0	20.0	100.9	20.5	20.0	G 1/8-28	150	0.38	N123G2-0300-0003-TF
	20 x 20	14.0	67.0	100.0	51.9	31.9	3	QS-R/LF123G14C2020E-067B	20.0	20.0	100.9	20.5	20.0	G 1/8-28	150	0.38	N123G2-0300-0003-TF
	20 x 20	14.0	90.0	160.0	51.9	31.9	3	QS-R/LF123G14C2020E-090B	20.0	20.0	100.9	20.5	20.0	G 1/8-28	150	0.27	N123G2-0300-0003-TF
H	20 x 20	20.0	40.0	60.0	60.0	40.0	3	QS-R/LF123H20C2020E-040B	20.0	20.0	108.9	20.5	20.0	G 1/8-28	150	0.40	N123H2-0400-0004-TF
	20 x 20	20.0	52.0	72.0	60.0	40.0	3	QS-R/LF123H20C2020E-052B	20.0	20.0	108.9	20.5	20.0	G 1/8-28	150	0.40	N123H2-0400-0004-TF
	20 x 20	20.0	64.0	100.0	60.0	40.0	3	QS-R/LF123H20C2020E-064B	20.0	20.0	108.9	20.5	20.0	G 1/8-28	150	0.39	N123H2-0400-0004-TF
	20 x 20	20.0	92.0	140.0	60.0	40.0	3	QS-R/LF123H20C2020E-092B	20.0	20.0	108.9	20.5	20.0	G 1/8-28	150	0.39	N123H2-0400-0004-TF
	20 x 20	20.0	132.0	230.0	60.0	40.0	3	QS-R/LF123H20C2020E-132B	20.0	20.0	108.9	20.5	20.0	G 1/8-28	150	0.39	N123H2-0400-0004-TF
	25 x 25	13.0	40.0	60.0	47.0	22.0	3	QS-R/LG123H13C2525E-040B	25.0	25.0	106.0	40.0	25.0	G 1/8-28	150	0.64	N123H2-0400-0004-TF
	25 x 25	13.0	52.0	72.0	47.0	22.0	3	QS-R/LG123H13C2525E-052B	25.0	25.0	106.0	40.0	25.0	G 1/8-28	150	0.50	N123H2-0400-0004-TF
	25 x 25	20.0	64.0	100.0	47.0	22.0	3	QS-R/LG123H20C2525E-064B	25.0	25.0	106.0	47.0	25.0	G 1/8-28	150	0.64	N123H2-0400-0004-TF
	25 x 25	20.0	92.0	140.0	47.0	22.0	3	QS-R/LG123H20C2525E-092B	25.0	25.0	106.0	47.0	25.0	G 1/8-28	150	0.64	N123H2-0400-0004-TF
	25 x 25	20.0	132.0	230.0	47.0	22.0	3	QS-R/LG123H20C2525E-132B	25.0	25.0	106.0	47.0	25.0	G 1/8-28	150	0.64	N123H2-0400-0004-TF

SSC = Para corresponder ao SSC na pastilha.

R = versão direita, L = versão esquerda

Componentes	
Plugue	Plugue
3214 013-01	3214 012-01

Para a lista completa de componentes, acesse www.sandvik.coromant.com



Cabeça CoroCut® 1-2 para canais frontais

Fixação por parafuso

CoroTurn® SL - Refrigeração interna

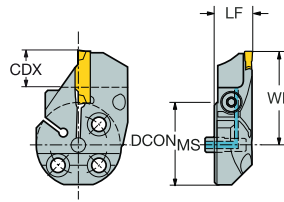
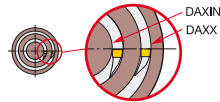

Curvatura A

SSC	CZC _{MS}	CDX	DAXIN	DAXX	OHX	CNSC	Código para pedido	Dimensões, mm						MIID	
								DCON _{MS}	LF	WF	HF	BAR	NM		KG
F	32	12.0	40.0	56.0	12.8	1	570-32R/L123F12B040A	32	14.0	34.4	0.1	10	2.0	0.11	N123F2-0250-0002-CM
	32	12.0	54.0	70.0	12.8	1	570-32R/L123F12B054A	32	14.0	34.4	0.1	10	2.0	0.11	N123F2-0250-0002-CM
	32	15.0	68.0	98.0	12.8	1	570-32R/L123F15B068A	32	14.0	37.4	0.1	10	2.0	0.11	N123F2-0250-0002-CM
	32	15.0	90.0	140.0	12.8	1	570-32R/L123F15B090A	32	14.0	37.4	0.1	10	2.0	0.12	N123F2-0250-0002-CM
	32	15.0	130.0	300.0	12.8	1	570-32R/L123F15B130A	32	14.0	37.4	0.1	10	2.0	0.12	N123F2-0250-0002-CM
G	32	12.0	34.0	44.0	16.5	1	570-32R/L123G12B034A	32	14.0	35.1	0.1	10	2.5	0.10	N123G2-0300-0003-TF
	32	15.0	42.0	60.0	12.5	1	570-32R/L123G15B042A	32	14.0	38.1	0.1	10	3.0	0.11	N123G2-0300-0003-TF
	32	15.0	54.0	75.0	12.5	1	570-32R/L123G15B054A	32	14.0	38.1	0.1	10	3.0	0.12	N123G2-0300-0003-TF
	32	18.0	67.0	100.0	12.5	1	570-32R/L123G18B067A	32	14.0	41.1	0.1	10	3.0	0.12	N123G2-0300-0003-TF
	32	18.0	90.0	160.0	12.5	1	570-32R/L123G18B090A	32	14.0	41.1	0.1	10	3.0	0.13	N123G2-0300-0003-TF
	32	18.0	130.0	300.0	12.5	1	570-32R/L123G18B130A	32	14.0	41.1	0.1	10	3.0	0.12	N123G2-0300-0003-TF
	32	18.0	300.0	1000.0	14.0	1	570-32R/L123G18B300A	32	14.0	41.1	0.1	10	3.0	0.13	N123G2-0300-0003-TF
H	32	18.0	40.0	60.0	16.0	1	570-32R/L123H18B040A	32	18.0	41.1	0.1	10	3.0	0.14	N123H2-0400-0004-TF
	32	18.0	52.0	72.0	16.0	1	570-32R/L123H18B052A	32	18.0	41.1	0.1	10	3.0	0.15	N123H2-0400-0004-TF
	32	18.0	64.0	100.0	16.0	1	570-32R/L123H18B064A	32	18.0	41.1	0.1	10	3.0	0.14	N123H2-0400-0004-TF
	32	18.0	92.0	140.0	16.0	1	570-32R/L123H18B092A	32	18.0	41.1	0.1	10	3.0	0.15	N123H2-0400-0004-TF
	32	18.0	132.0	230.0	16.0	1	570-32R/L123H18B132A	32	18.0	41.1	0.1	10	3.0	0.15	N123H2-0400-0004-TF
	32	18.0	220.0	500.0	16.0	1	570-32R/L123H18B220A	32	18.0	41.1	0.1	10	3.0	0.15	N123H2-0400-0004-TF
	32	18.0	300.0	800.0	16.0	1	570-32R/L123H18B300A	32	18.0	41.1	0.1	10	3.0	0.15	N123H2-0400-0004-TF
	40	18.0	40.0	60.0	18.0	1	570-40R/L123H18B040A	40	18.0	45.1	0.1	10	3.0	0.18	N123H2-0400-0004-TF
	40	18.0	52.0	72.0	18.0	1	570-40R/L123H18B052A	40	18.0	45.1	0.1	10	3.0	0.19	N123H2-0400-0004-TF
	40	18.0	64.0	100.0	18.0	1	570-40R/L123H18B064A	40	18.0	45.1	0.1	10	3.0	0.19	N123H2-0400-0004-TF
	40	18.0	92.0	140.0	18.0	1	570-40R/L123H18B092A	40	18.0	45.1	0.1	10	3.0	0.20	N123H2-0400-0004-TF
	40	18.0	132.0	230.0	18.0	1	570-40R/L123H18B132A	40	18.0	45.1	0.1	10	3.0	0.21	N123H2-0400-0004-TF
	40	18.0	220.0	500.0	18.0	1	570-40R/L123H18B220A	40	18.0	45.1	0.1	10	3.0	0.21	N123H2-0400-0004-TF
	40	18.0	300.0	800.0	18.0	1	570-40R/L123H18B300A	40	18.0	45.1	0.1	10	3.0	0.21	N123H2-0400-0004-TF
J	32	18.0	40.0	70.0	15.5	1	570-32R/L123J18B040A	32	18.0	41.1	0.1	10	3.5	0.14	N123J2-0500-0004-TF
	32	18.0	60.0	95.0	15.5	1	570-32R/L123J18B060A	32	18.0	41.1	0.1	10	3.5	0.15	N123J2-0500-0004-TF
	32	18.0	85.0	130.0	15.5	1	570-32R/L123J18B085A	32	18.0	41.1	0.1	10	3.5	0.15	N123J2-0500-0004-TF
	32	18.0	120.0	180.0	15.5	1	570-32R/L123J18B120A	32	18.0	41.1	0.1	10	3.5	0.15	N123J2-0500-0004-TF
	32	18.0	175.0	500.0	15.5	1	570-32R/L123J18B175A	32	18.0	41.1	0.1	10	3.5	0.15	N123J2-0500-0004-TF
	32	18.0	180.0	980.0	15.5	1	570-32R/L123J18B180A	32	18.0	41.1	0.1	10	3.5	0.15	N123J2-0500-0004-TF
	40	18.0	40.0	70.0	18.0	1	570-40R/L123J18B040A	40	18.0	45.1	0.1	10	3.5	0.18	N123J2-0500-0004-TF
	40	18.0	60.0	95.0	18.0	1	570-40R/L123J18B060A	40	18.0	45.1	0.1	10	3.5	0.20	N123J2-0500-0004-TF
	40	18.0	85.0	130.0	18.0	1	570-40R/L123J18B085A	40	18.0	45.1	0.1	10	3.5	0.20	N123J2-0500-0004-TF
	40	18.0	120.0	180.0	18.0	1	570-40R/L123J18B120A	40	18.0	45.1	0.1	10	3.5	0.21	N123J2-0500-0004-TF
K	32	18.0	40.0	70.0	15.0	1	570-32R/L123K18B040A	32	18.0	41.1	0.1	10	4.0	0.14	N123K2-0600-0004-TF
	32	18.0	58.0	100.0	15.0	1	570-32R/L123K18B058A	32	18.0	41.1	0.1	10	4.0	0.15	N123K2-0600-0004-TF
	32	18.0	88.0	180.0	15.0	1	570-32R/L123K18B088A	32	18.0	41.1	0.1	10	4.0	0.15	N123K2-0600-0004-TF
	32	18.0	168.0	400.0	15.0	1	570-32R/L123K18B168A	32	18.0	41.1	0.1	10	4.0	0.15	N123K2-0600-0004-TF
	32	18.0	220.0	1000.0	15.0	1	570-32R/L123K18B220A	32	18.0	41.1	0.1	10	4.0	0.16	N123K2-0600-0004-TF
	40	18.0	40.0	70.0	18.0	1	570-40R/L123K18B040A	40	18.0	45.1	0.1	10	4.0	0.19	N123K2-0600-0004-TF
	40	18.0	58.0	100.0	18.0	1	570-40R/L123K18B058A	40	18.0	45.1	0.1	10	4.0	0.20	N123K2-0600-0004-TF
	40	18.0	88.0	180.0	18.0	1	570-40R/L123K18B088A	40	18.0	45.1	0.1	10	4.0	0.21	N123K2-0600-0004-TF
	40	18.0	168.0	400.0	18.0	1	570-40R/L123K18B168A	40	18.0	45.1	0.1	10	4.0	0.21	N123K2-0600-0004-TF
	40	18.0	220.0	1000.0	18.0	1	570-40R/L123K18B220A	40	18.0	45.1	0.1	10	4.0	0.21	N123K2-0600-0004-TF

SSC = Para corresponder ao SSC na pastilha.

R = versão direita, L = versão esquerda

Componentes			
SSC	CZC _{MS}	Parafuso	Tubo para refrigeração
F	32	3212 012-260	5691 041-01
G	32	3212 012-310	5691 041-01
H,J,K	32	3212 012-310	5691 041-02
H,J,K	40	3212 012-311	5691 041-01

Para a lista completa de componentes, acesse www.sandvik.coromant.com



B4



F2



H36



H35



H5



H2



Cabeça CoroCut® 1-2 para canais frontais

Fixação por parafuso

CoroTurn® SL - Refrigeração interna

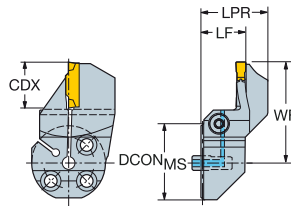
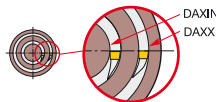

Curvatura B

SSC	CZC _{MS}	CDX	DAXIN	DAXX	OHX	CNSC	Código para pedido	Dimensões, mm							MID	
								DCON _{MS}	LPR	LF	WF	HF	BAR	NM		KG
F	32	12.0	40.0	56.0	12.8	1	570-32R/L123F12B040B	32	19.9	14.0	34.4	0.1	10	2.0	0.12	N123F2-0250-0002-CM
	32	12.0	54.0	70.0	12.8	1	570-32R/L123F12B054B	32	21.4	14.0	34.4	0.1	10	2.0	0.12	N123F2-0250-0002-CM
	32	15.0	68.0	98.0	12.8	1	570-32R/L123F15B068B	32	18.6	14.0	37.4	0.1	10	2.0	0.12	N123F2-0250-0002-CM
	32	15.0	90.0	140.0	12.8	1	570-32R/L123F15B090B	32	17.1	14.0	37.4	0.1	10	2.0	0.12	N123F2-0250-0002-CM
	32	15.0	130.0	300.0	12.8	1	570-32R/L123F15B130B	32	15.3	14.0	37.4	0.1	10	2.0	0.12	N123F2-0250-0002-CM
G	32	12.0	34.0	44.0	16.5	1	570-32R/L123G12B034B	32	26.0	14.0	35.1	0.1	10	2.5	0.13	N123G2-0300-0003-TF
	32	15.0	42.0	60.0	12.5	1	570-32R/L123G15B042B	32	21.1	14.0	38.1	0.1	10	3.0	0.13	N123G2-0300-0003-TF
	32	15.0	54.0	75.0	12.5	1	570-32R/L123G15B054B	32	20.7	14.0	38.1	0.1	10	3.0	0.13	N123G2-0300-0003-TF
	32	18.0	67.0	100.0	12.5	1	570-32R/L123G18B067B	32	18.1	14.0	41.1	0.1	10	3.0	0.13	N123G2-0300-0003-TF
	32	18.0	90.0	160.0	12.5	1	570-32R/L123G18B090B	32	16.3	14.0	41.1	0.1	10	3.0	0.13	N123G2-0300-0003-TF
	32	18.0	130.0	300.0	12.5	1	570-32R/L123G18B130B	32	15.1	14.0	41.1	0.1	10	3.0	0.12	N123G2-0300-0003-TF
H	32	18.0	40.0	60.0	16.0	1	570-32R/L123H18B040B	32	26.9	18.0	41.1	0.1	10	3.0	0.15	N123H2-0400-0004-TF
	32	18.0	52.0	72.0	16.0	1	570-32R/L123H18B052B	32	24.6	18.0	41.1	0.1	10	3.0	0.15	N123H2-0400-0004-TF
	32	18.0	64.0	100.0	16.0	1	570-32R/L123H18B064B	32	22.2	18.0	41.1	0.1	10	3.0	0.15	N123H2-0400-0004-TF
	32	18.0	92.0	140.0	16.0	1	570-32R/L123H18B092B	32	20.8	18.0	41.1	0.1	10	3.0	0.15	N123H2-0400-0004-TF
	32	18.0	132.0	230.0	16.0	1	570-32R/L123H18B132B	32	19.5	18.0	41.1	0.1	10	3.0	0.15	N123H2-0400-0004-TF
	32	18.0	220.0	500.0	16.0	1	570-32R/L123H18B220B	32	18.5	18.0	41.1	0.1	10	3.0	0.05	N123H2-0400-0004-TF
	32	18.0	300.0	800.0	16.0	1	570-32R/L123H18B300B	32	18.2	18.0	41.1	0.1	10	3.0	0.15	N123H2-0400-0004-TF
	40	18.0	40.0	60.0	18.0	1	570-40R/L123H18B040B	40	28.3	18.0	45.1	0.1	10	3.0	0.21	N123H2-0400-0004-TF
	40	18.0	52.0	72.0	18.0	1	570-40R/L123H18B052B	40	29.5	18.0	45.1	0.1	10	3.0	0.21	N123H2-0400-0004-TF
	40	18.0	64.0	100.0	18.0	1	570-40R/L123H18B064B	40	25.0	18.0	45.1	0.1	10	3.0	0.21	N123H2-0400-0004-TF
J	32	18.0	40.0	70.0	15.5	1	570-32R/L123J18B040B	32	25.2	18.0	41.1	0.1	10	3.5	0.14	N123J2-0500-0004-TF
	32	18.0	60.0	95.0	15.5	1	570-32R/L123J18B060B	32	22.7	18.0	41.1	0.1	10	3.5	0.30	N123J2-0500-0004-TF
	32	18.0	85.0	130.0	15.5	1	570-32R/L123J18B085B	32	21.1	18.0	41.1	0.1	10	3.5	0.15	N123J2-0500-0004-TF
	32	18.0	120.0	180.0	15.5	1	570-32R/L123J18B120B	32	20.1	18.0	41.1	0.1	10	3.5	0.15	N123J2-0500-0004-TF
	32	18.0	175.0	500.0	15.5	1	570-32R/L123J18B175B	32	18.5	18.0	41.1	0.1	10	3.5	0.15	N123J2-0500-0004-TF
	32	18.0	180.0	980.0	15.5	1	570-32R/L123J18B180B	32	18.1	18.0	41.1	0.1	10	3.5	0.15	N123J2-0500-0004-TF
	40	18.0	40.0	70.0	18.0	1	570-40R/L123J18B040B	40	26.5	18.0	45.1	0.1	10	3.5	0.21	N123J2-0500-0004-TF
	40	18.0	60.0	95.0	18.0	1	570-40R/L123J18B060B	40	25.8	18.0	45.1	0.1	10	3.5	0.21	N123J2-0500-0004-TF
	40	18.0	85.0	130.0	18.0	1	570-40R/L123J18B085B	40	23.1	18.0	45.1	0.1	10	3.5	0.21	N123J2-0500-0004-TF
	40	18.0	120.0	180.0	18.0	1	570-40R/L123J18B120B	40	21.4	18.0	45.1	0.1	10	3.5	0.21	N123J2-0500-0004-TF
K	32	18.0	40.0	70.0	15.0	1	570-32R/L123K18B040B	32	25.6	18.0	41.1	0.1	10	4.0	0.16	N123K2-0600-0004-TF
	32	18.0	58.0	100.0	15.0	1	570-32R/L123K18B058B	32	22.5	18.0	41.1	0.1	10	4.0	0.15	N123K2-0600-0004-TF
	32	18.0	88.0	180.0	15.0	1	570-32R/L123K18B088B	32	20.1	18.0	41.1	0.1	10	4.0	0.15	N123K2-0600-0004-TF
	32	18.0	168.0	400.0	15.0	1	570-32R/L123K18B168B	32	18.7	18.0	41.1	0.1	10	4.0	0.15	N123K2-0600-0004-TF
	32	18.0	220.0	1000.0	15.0	1	570-32R/L123K18B220B	32	18.1	18.0	41.1	0.1	10	4.0	0.15	N123K2-0600-0004-TF
	40	18.0	40.0	70.0	18.0	1	570-40R/L123K18B040B	40	30.0	18.0	45.1	0.1	10	4.0	0.22	N123K2-0600-0004-TF
	40	18.0	58.0	100.0	18.0	1	570-40R/L123K18B058B	40	25.4	18.0	45.1	0.1	10	4.0	0.22	N123K2-0600-0004-TF
	40	18.0	88.0	180.0	18.0	1	570-40R/L123K18B088B	40	21.5	18.0	45.1	0.1	10	4.0	0.22	N123K2-0600-0004-TF
	40	18.0	168.0	400.0	18.0	1	570-40R/L123K18B168B	40	19.3	18.0	45.1	0.1	10	4.0	0.21	N123K2-0600-0004-TF
	40	18.0	220.0	1000.0	18.0	1	570-40R/L123K18B220B	40	18.3	18.0	45.1	0.1	10	4.0	0.21	N123K2-0600-0004-TF

SSC = Para corresponder ao SSC na pastilha.

R = versão direita, L = versão esquerda

SSC		Componentes	
SSC	CZC _{MS}	Parafuso	Tubo para refrigeração
F	32	3212 012-260	5691 041-01
G	32	3212 012-310	5691 041-01
H,J,K	32	3212 012-310	5691 041-02
H,J,K	40	3212 012-311	5691 041-01

Para a lista completa de componentes, acesse www.sandvik.coromant.com



B4



F2



H36



H35



H5



H2

Ferramenta convencional CoroCut® 1-2 para perfilamento

Fixação por parafuso

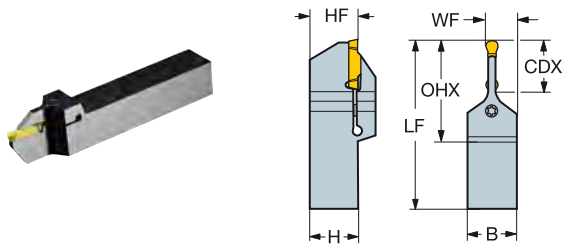

		Dimensões, mm										
SSC	CZC _{MS}	CDX	OHX	Código para pedido	B	H	LF	WF	HF	NM	KG	MID
J	25 x 25	25.0	52.2	NF123J25-2525BM	25.0	25.0	150.0	15.0	25.0	6.0	0.66	N123J2-0600- RM
	32 x 25	25.0	52.2	NF123J25-3225BM	25.0	32.0	170.0	15.0	32.0	6.0	0.97	N123J2-0600- RM

R/LX123..B-007

R/LX123..B-045

R/LX123..B-070

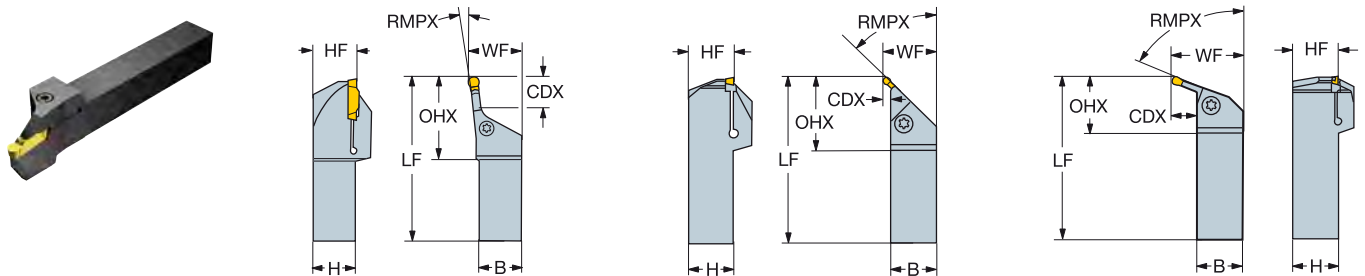

		Dimensões, mm											
SSC	CZC _{MS}	CDX	RMPX	OHX	Código para pedido	B	H	LF	WF	HF	NM	KG	MID
L	25 x 25	25.0	7°	63.7	R/LX123L25-2525B-007	25.0	25.0	190.0	32.0	25.0	6.5	0.99	N123L2-0800- RM
	32 x 32	25.0	7°	63.7	R/LX123L25-3232B-007	32.0	32.0	190.0	40.0	32.0	6.5	1.45	N123L2-0800- RM
G	20 x 20	4.0	45°	41.1	R/LX123G04-2020B-045	20.0	20.0	150.0	24.0	20.0	4.5	0.48	N123G2-0400- RM
	25 x 25	4.0	45°	41.1	R/LX123G04-2525B-045	25.0	25.0	150.0	29.0	25.0	4.5	0.73	N123G2-0400- RM
J	20 x 20	5.0	45°	44.9	R/LX123J05-2020B-045	20.0	20.0	150.0	25.0	20.0	5.0	0.53	N123J2-0600- RM
	25 x 25	5.0	45°	44.9	R/LX123J05-2525B-045	25.0	25.0	150.0	30.0	25.0	5.0	0.75	N123J2-0600- RM
	32 x 25	5.0	45°	44.9	R/LX123J05-3225B-045	25.0	32.0	150.0	30.0	32.0	5.0	0.92	N123J2-0600- RM
J	25 x 25	16.0	70°	40.0	R/LX123J16-2525B-070	25.0	25.0	190.0	41.7	25.0	5.0	1.00	N123J2-0600- RM
	32 x 32	16.0	70°	40.0	R/LX123J16-3232B-070	32.0	32.0	190.0	48.7	32.0	5.0	1.60	N123J2-0600- RM

SSC = Para corresponder ao SSC na pastilha.

N = neutra, R = versão direita, L = versão esquerda

Componentes	
Código para pedido	Parafuso
R/LX123G04-2020B-045	3212 012-309
R/LX123G04-2525B-045	3212 012-309
R/LX123J05-2020B-045	3212 012-360
R/LX123J05-2525B-045	3212 012-360
R/LX123J16-2525B-070	3212 012-360
NF123J25-2525BM	5512 044-01
R/LX123J05-3225B-045	3212 012-360
NF123J25-3225BM	5512 044-01
R/LX123J16-3232B-070	3212 012-360
R/LX123L25-2525B-007	3212 012-360
R/LX123L25-3232B-007	3212 012-360

Para a lista completa de componentes, acesse www.sandvik.coromant.com



B4



F2



E1



H36



H35



H18



H5



Cabeça CoroCut® 1-2 para perfilamento

Fixação por parafuso

CoroTurn® SL70 - Refrigeração de precisão

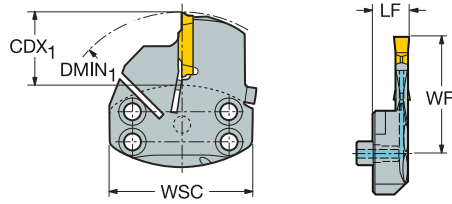

SSC	CZC _{MS}	CDX ₁	DMIN ₁	DAXIN	OHX	CNSC	Código para pedido	Dimensões, mm					MIID	
								LF	WF	WSC	BAR	NM		KG
G	70	15.0	100.0	794.0	14.0	1	SL70-R/L123G15A-HP	15.5	48.0	70.0	80	4.0	0.27	N123G2-0300-GM
H	70	30.0	100.0	792.0	14.0	1	SL70-R/L123H30A-HP	16.0	56.0	70.0	80	4.5	0.30	N123H2-0400-GM
K	70	15.0	120.0	308.0	15.0	1	SL70-R/L123K15A-HP	18.0	36.0	70.0	80	2.0	0.29	N123K2-0600-GM
	70	30.0	120.0	308.0	14.0	1	SL70-R/L123K30A-HP-M	17.0	55.0	70.0	80	4.5	0.32	N123K2-0600-GM
L	70	45.0	120.0	308.0	15.0	1	SL70-R/L123K45A-HP	18.0	71.0	70.0	80	6.0	0.36	N123K2-0600-GM
	70	35.0	90.0	254.0	14.0	1	SL70-R/L123L35A-HP-M	18.0	61.0	70.0	80	6.5	0.35	N123L2-0800-GM
M	70	50.0	105.0	324.0	14.0	1	SL70-R/L123L50A-HP	18.0	81.0	70.0	80	6.5	0.39	N123L2-0800-GM
	70	50.0	100.0	428.0	12.0	1	SL70-R/L123M50A-HP	17.5	71.0	70.0	80	5.0	0.41	N123M1-1100-0008-GM
R	70	65.0	125.0	470.0	9.0	1	SL70-R/L123R65A-HP	16.5	71.0	70.0	80	6.5	0.59	N123R1-1500-0010-GR

SSC = Para corresponder ao SSC na pastilha.

R = versão direita, L = versão esquerda

Código para pedido	Componentes		
	Parafuso	Olhal	Bucha-guia
SL70-R/L123G15A-HP	3212 010-312	5691 026-23	5552 058-04
SL70-R/L123H30A-HP	3212 010-313	5691 026-23	5552 058-04
SL70-R/L123K15A-HP	3214 010-306	5691 026-23	5552 058-04
SL70-R/L123K30A-HP-M	3212 010-313	5691 026-23	5552 058-04
SL70-R/L123K45A-HP	3212 010-313	5691 026-23	5552 058-04
SL70-R/L123L35A-HP-M	3212 010-313	5691 026-23	5552 058-04
SL70-R/L123L50A-HP	3212 010-313	5691 026-23	5552 058-04
SL70-R/L123M50A-HP	3212 010-314	5691 026-23	5552 058-04
SL70-R/L123R65A-HP	3212 010-365	5691 026-23	5552 058-04

Para a lista completa de componentes, acesse www.sandvik.coromant.com



Cabeça CoroCut® 1-2 para perfilamento

Fixação por parafuso

CoroTurn® SL70 - Refrigeração interna de precisão

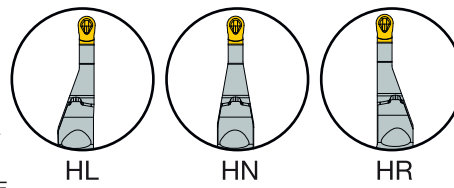
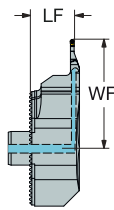
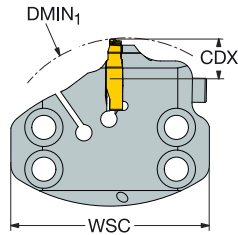

					Dimensões, mm							
SSC	CZC _{MS}	CDX	DMIN ₁	CNSC	Código para pedido	LF	WF	WSC	BAR	NM	KG	MIID
HL	70	11.0	100.0	1	SL70-R/L123H11LC-HP	15.5	38.4	70.0	80	3.1	0.31	L123H1-0200
HN	70	11.0	100.0	1	SL70-R/L123H11NC-HP	16.5	38.4	70.0	80	3.1	0.31	N123H1-0200
HR	70	11.0	100.0	1	SL70-R/L123H11RC-HP	17.4	38.4	70.0	80	3.1	0.31	R123H1-0200

SSC = Para corresponder ao SSC na pastilha.

R = versão direita, L = versão esquerda

Componentes		
Parafuso	Olhal	Bucha-guia
3212 010-313	5691 026-23	5552 058-04

Para a lista completa de componentes, acesse www.sandvik.coromant.com



Cabeça CoroCut® 1-2 para canais

Fixação por parafuso

CoroTurn® SL70 - Refrigeração interna de precisão

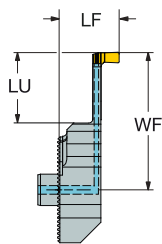
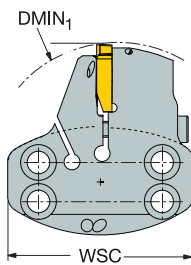

SSC	CZC _{MS}	CDX ₁	CDX ₂	DMIN ₁	LU	CNCS	Código para pedido	Dimensões, mm						MIID
								LF	WF	WSC	BAR	NM	KG	
H	70	4.2	5.9	105.0	25.0	1	SL70-R/LG123H06C	22.9	52.0	70.0	30	8.0	0.30	RG123H1-0300-RO
L	70	6.0	9.8	150.0	31.0	1	SL70-R/LG123L09C	27.7	61.0	70.0	30	8.5	0.36	RG123L1-0300-RO

SSC = Para corresponder ao SSC na pastilha. R = versão direita, L = versão esquerda

Nota: Pastilhas versão esquerda são usadas nos suportes versão direita, pastilhas versão direita são usadas nos suportes versão esquerda.

Componentes	
Parafuso	Bucha-guia
3212 020-363	5552 058-04

Para a lista completa de componentes, acesse www.sandvik.coromant.com



Barra de mandrilar CoroCut® 1-2 para canais

Fixação por parafuso

Cilíndrica com ranhura para bucha EasyFix - Refrigeração de precisão

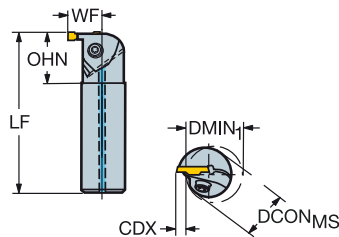
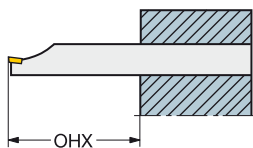

SSC	CZC _{MS}	CDX	DMIN ₁	OHX	OHN	CNSC	Código para pedido	Dimensões, mm						MIID
								DCON _{MS}	LF	WF	BAR	NM	KG	
D	16	4.5	25.0	64.0	25.0	1	R/LAG123D04-16B	16	150.0	12.5	10	3.0	0.22	N123D2-0150-0002-CM
	20	5.0	32.0	80.0	30.0	1	R/LAG123D05-20B	20	180.0	15.3	10	3.0	0.43	N123D2-0150-0002-CM
E	20	5.0	32.0	80.0	30.0	1	R/LAG123E05-20B	20	180.0	15.3	10	3.5	0.42	N123E2-0200- GM
	25	7.0	32.0	100.0	35.0	1	R/LAG123E07-25B	25	200.0	19.8	10	3.5	0.72	N123E2-0200- GM
G	20	6.0	32.0	80.0	30.0	1	R/LAG123G06-20B	20	180.0	15.3	10	4.0	0.42	N123G2-0300- GM
	25	7.0	32.0	100.0	35.0	1	R/LAG123G07-25B	25	200.0	19.8	10	4.0	0.71	N123G2-0300- GM
H	25	7.0	32.0	100.0	35.0	1	R/LAG123H07-25B	25	200.0	19.3	10	4.5	0.70	N123H2-0400- GM
J	25	8.0	32.0	100.0	35.0	1	R/LAG123J08-25B	25	200.0	19.8	10	5.0	0.71	N123J2-0500- GM

SSC = Para corresponder ao SSC na pastilha.

R = versão direita, L = versão esquerda

Componentes		
SSC	CZC _{MS}	Parafuso de fixação
D	16-20	5512 031-03
E	20	5512 031-03
E	25	3212 012-259
G	20	5512 031-03
G	25	3212 012-309
H	25	3212 012-309
J	25	3212 012-309

Para a lista completa de componentes, acesse www.sandvik.coromant.com



Barra de mandrilar CoroCut® 1-2 para canais

Fixação por parafuso

Cilíndrica com planos - Refrigeração interna

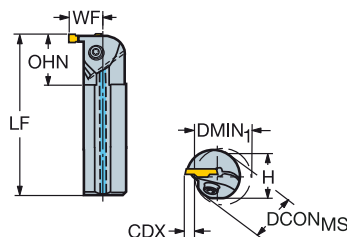
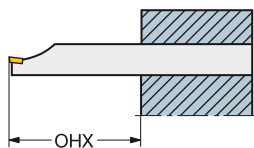

SSC	CZC _{MS}	CDX	DMIN ₁	OHX	OHN	CNCS	Código para pedido	Dimensões, mm						MIID	
								DCON _{MS}	H	LF	WF	BAR	NM		KG
E	32	9.5	40.0	128.0	45.0	1	R/LAG123E09-32B	32	30.0	250.0	25.5	10	4.0	1.44	N123E2-0200- GM
G	32	9.0	40.0	128.0	45.0	1	R/LAG123G09-32B	32	30.0	250.0	25.3	10	4.5	1.44	N123G2-0300- GM
		11.0	50.0	160.0	55.0	1	R/LAG123G11-40B	40	37.0	300.0	31.0	10	4.5	2.64	N123G2-0300- GM
		10.0	40.0	128.0	45.0	1	R/LAG123H10-32B	32	30.0	250.0	26.5	10	4.5	1.43	N123H2-0400- GM
H	40	11.0	50.0	160.0	55.0	1	R/LAG123H11-40B	40	37.0	300.0	31.0	10	5.0	2.65	N123H2-0400- GM
		13.0	60.0	200.0	65.0	1	R/LAG123H13-50B	50	47.0	350.0	38.3	10	5.0	4.96	N123H2-0400- GM
J	32	11.0	40.0	128.0	45.0	1	R/LAG123J11-32B	32	30.0	250.0	27.0	10	5.0	1.42	N123J2-0500- GM
		11.0	50.0	160.0	55.0	1	R/LAG123J11-40B	40	37.0	300.0	31.0	10	5.5	2.64	N123J2-0500- GM
		13.0	60.0	200.0	65.0	1	R/LAG123J13-50B	50	47.0	350.0	38.3	10	5.5	5.22	N123J2-0500- GM
K	40	11.0	50.0	160.0	55.0	1	R/LAG123K11-40B	40	37.0	300.0	31.0	10	5.5	2.37	N123K2-0600- GM
		13.0	60.0	200.0	65.0	1	R/LAG123K13-50B	50	47.0	350.0	38.3	10	5.5	4.96	N123K2-0600- GM

SSC = Para corresponder ao SSC na pastilha.

R = versão direita, L = versão esquerda

		Componentes
SSC	CZC _{MS}	Parafuso de fixação
E	32	3212 012-259
G	32	3212 012-309
G	40	3212 012-310
H	32	3212 012-359
H	40-50	3212 012-360
J	32	3212 012-359
J	40-50	3212 012-360
K	40-50	3212 012-360

Para a lista completa de componentes, acesse www.sandvik.coromant.com



Barra de mandrilar CoroCut® 1-2 para perfilamento

Fixação por parafuso

Cilíndrica com planos - Refrigeração interna

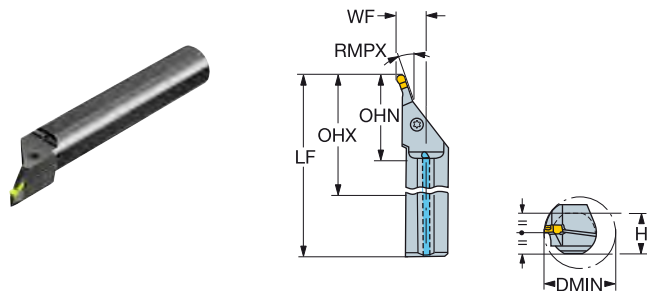

		Dimensões, mm															
SSC	CZC _{MS}	CDX	DMIN ₁	RMPX	OHX	OHN	CNSC	Código para pedido	DCON _{MS}	H	LF	WF	HF	BAR	NM	KG	MIID
J	40	25.0	63.5	20°	160.0	65.6	1	R/LAX123J25-40B-020	40	37.0	254.0	26.0	18.5	10	3.0	2.14	N123J2-0600-AM
L	40	25.0	63.5	20°	160.0	65.6	1	R/LAX123L25-40B-020	40	37.0	254.0	26.0	18.5	10	3.0	2.11	N123L2-0800-AM

SSC = Para corresponder ao SSC na pastilha.

R = versão direita,
L = versão esquerda

Componentes
Parafuso de fixação
5512 044-01

Para a lista completa de componentes, acesse www.sandvik.coromant.com



CoroCut® QD

Para cortes e usinagem de canais profundos e com segurança

Aplicação

- Corte
- Usinagem de canais profundos
- Na usinagem com longos balanços

Área de aplicação ISO:



Características e benefícios

- Geometrias de pastilha que otimizam o acesso à refrigeração
- Classes de pastilha com alta segurança da aresta de corte
- Geometrias quebra-cavacos
- Ligas com alta resistência à fadiga
- Não é necessário um torquímetro, pois a força de fixação correta é garantida com a chave de liberação rápida
- O assento tipo trilho da pastilha assegura posição estável e precisa da pastilha



www.sandvik.coromant.com/corocutqd

Ferramentas

- Unidades de corte Coromant Capto®
- Lâminas para cortar
- Ferramentas convencionais
- Ferramentas convencionais QST™
- Cabeças CoroTurn® SL

Pastilhas

- Geometrias e classes de pastilhas específicas para cortes
- Pastilhas Wiper para excelente acabamento superficial

Chave para indexação da pastilha

Chave de liberação rápida para indexação da pastilha com apenas uma mão.







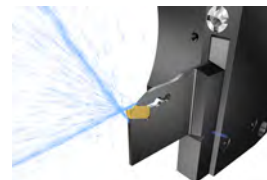



Refrigeração de precisão



Todas as ferramentas fornecem refrigeração superior e inferior para melhor controle de cavacos e vida útil da ferramenta. Os adaptadores têm a função plug-and-play para fácil conexão na máquina.



Pastilhas

	Cortes					Canais	Torneamento	Perfilamento
								
	QD-CF	QD-CL	QD-CM	QD-CO	QD-CR	QD-GM	QD-TF/TM	QD-RM
Largura da pastilha, mm	1.00-3.00	2.50-8.00	1.00-8.00	2.00-6.00	2.00-6.00	6.00-8.00	3.00-8.00	3.00-8.00
Página	B52	B52	B53	B53	B53	B54	B55	B56

Ferramentas

			
Sistemas de fixação	Cortes e canais	Cortes	Canais
Coromant Capto®	B57		
Lâmina			
Refrigeração de precisão Acoplamento neutro Acoplamento versão direita Acoplamento versão esquerda		B61-B62 B63 B64	
Sem refrigeração Acoplamento neutro Acoplamento versão direita Acoplamento versão esquerda		B65 B66 B67	
Haste			
Refrigeração de precisão	B58		
Sem refrigeração	B59		
Haste QS	B60		
Cabeça de corte CoroTurn® SL			B68

Pastilha CoroCut® QD para corte

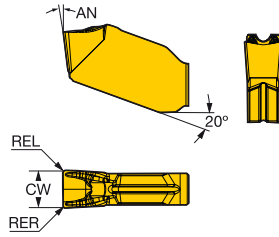

Wiper TECHNOLOGY

	SSC	CW	REL	RER	Código para pedido	Dimensões, mm																			
						P				M				K		N		S			H				
						1105	1125	1135	1145	1105	1125	1135	1145	1125	1135	4325	1105	1125	1135	1105	1125	1135	1145	1135	AN
Acabamento	B	1.00	0.07	0.07	QD-NB-0100-0001-CF	☆	☆	☆	☆	☆	☆	☆	☆	☆	☆	☆	☆	☆	☆	☆	☆	☆	☆	☆	7°
	C	1.20	0.10	0.10	QD-NC-0120-0001-CF	☆	☆	☆	☆	☆	☆	☆	☆	☆	☆	☆	☆	☆	☆	☆	☆	☆	☆	☆	7°
	D	1.50	0.10	0.10	QD-ND-0150-0001-CF	☆	☆	☆	☆	☆	☆	☆	☆	☆	☆	☆	☆	☆	☆	☆	☆	☆	☆	☆	7°
	E	2.00	0.15	0.15	QD-NE-0200-0001-CF	☆	☆	☆	☆	☆	☆	☆	☆	☆	☆	☆	☆	☆	☆	☆	☆	☆	☆	☆	7°
	F	2.50	0.15	0.15	QD-NF-0250-0001-CF	☆	☆	☆	☆	☆	☆	☆	☆	☆	☆	☆	☆	☆	☆	☆	☆	☆	☆	☆	7°
	G	3.00	0.15	0.15	QD-NG-0300-0001-CF	☆	☆	☆	☆	☆	☆	☆	☆	☆	☆	☆	☆	☆	☆	☆	☆	☆	☆	☆	7°
Média	E	2.00	0.30	0.30	QD-NE-0200-0003-CL	☆	☆	☆	☆	☆	☆	☆	☆	☆	☆	☆	☆	☆	☆	☆	☆	☆	☆	☆	7°
	F	2.50	0.30	0.30	QD-NF-0250-0003-CL	☆	☆	☆	☆	☆	☆	☆	☆	☆	☆	☆	☆	☆	☆	☆	☆	☆	☆	☆	7°
	G	3.00	0.30	0.30	QD-NG-0300-0003-CL	☆	☆	☆	☆	☆	☆	☆	☆	☆	☆	☆	☆	☆	☆	☆	☆	☆	☆	☆	7°
	H	4.00	0.30	0.30	QD-NH-0400-0003-CL	☆	☆	☆	☆	☆	☆	☆	☆	☆	☆	☆	☆	☆	☆	☆	☆	☆	☆	☆	7°
	J	5.00	0.40	0.40	QD-NJ-0500-0004-CL	☆	☆	☆	☆	☆	☆	☆	☆	☆	☆	☆	☆	☆	☆	☆	☆	☆	☆	☆	7°
	K	6.00	0.40	0.40	QD-NK-0600-0004-CL	☆	☆	☆	☆	☆	☆	☆	☆	☆	☆	☆	☆	☆	☆	☆	☆	☆	☆	☆	7°
	L	8.00	0.40	0.40	QD-NL-0800-0004-CL	☆	☆	☆	☆	☆	☆	☆	☆	☆	☆	☆	☆	☆	☆	☆	☆	☆	☆	☆	7°

SSC = Para corresponder ao SSC no suporte.

N = neutra

Tolerâncias:

	CWTOLL	CWTOLU	RETOLL	RETOLU
QD-N...-CF	-0.050	0.050	-0.05	0.05
QD-N...-CL	-0.050	0.050	-0.05	0.05



Pastilha CoroCut® QD para canais

B

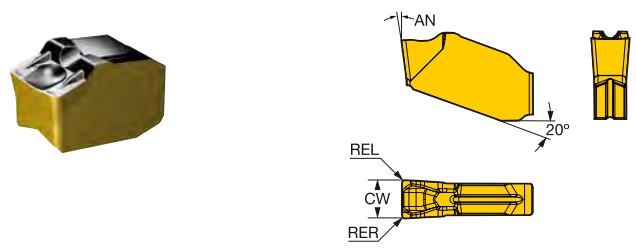

C

				P	M	K	N	S	H	Dimensões, mm											
	SSC	CW	REL	RER	Código para pedido						AN										
Média	K	6.00	0.40	0.40	QD-NK-0600-0004-GM	1125	1135	1145	1125	1135	1145	1125	1135	1145	1125	1135	1145	1125	1135	1145	7°
	L	8.00	0.80	0.80	QD-NL-0800-0008-GM	☆	★	☆	☆	★	☆	☆	★	☆	☆	★	☆	☆	★	☆	☆

D

SSC = Para corresponder ao SSC no suporte. N = neutra

Tolerâncias:				
	CWTOLL	CWTOLU	RETOLL	RETOLU
QD-N..-GM	-0.050	0.050	-0.05	0.05

E

F

G

H

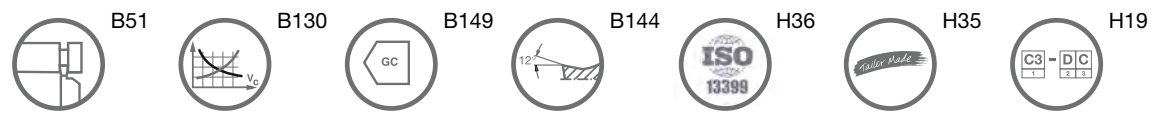

Pastilha CoroCut® QD para torneamento

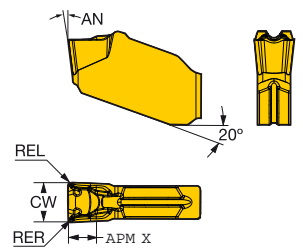

Acabamento	SSC	CW	REL	RER	Código para pedido	Dimensões, mm																				
						P				M				K		N		S			H					
	G	3.00	0.30	0.30	QD-NG-0300-0003-TF	1105	1125	1135	1145	4325	1105	1125	1135	1145	1135	4325	1135	1125	1135	1145	1135	1125	1135	1145	1135	AN
	H	4.00	0.40	0.40	QD-NH-0400-0004-TF	☆	☆	★	☆	☆	☆	☆	★	☆	☆	★	☆	☆	☆	☆	★	☆	☆	☆	★	7°
	J	5.00	0.40	0.40	QD-NJ-0500-0004-TF	☆	☆	★	☆	☆	☆	☆	★	☆	☆	★	☆	☆	☆	☆	★	☆	☆	☆	★	7°
	K	6.00	0.40	0.40	QD-NK-0600-0004-TF	☆	☆	★	☆	☆	☆	☆	★	☆	☆	★	☆	☆	☆	☆	★	☆	☆	☆	★	7°
	L	8.00	0.80	0.80	QD-NL-0800-0008-TF	☆	☆	★	☆	☆	☆	☆	★	☆	☆	★	☆	☆	☆	☆	★	☆	☆	☆	★	7°

B

C

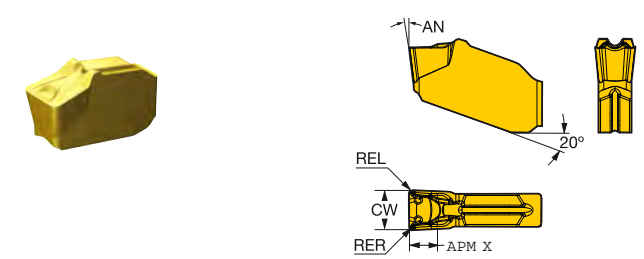

Média	SSC	CW	REL	RER	Código para pedido	Dimensões, mm																				
						P				M				K		N		S			H					
	G	3.00	0.40	0.40	QD-NG-0300-0004-TM	1125	1135	1125	1135	1125	1135	1125	1135	1125	1135	1125	1135	1125	1135	1125	1135	1125	1135	AN		
	H	4.00	0.40	0.40	QD-NH-0400-0004-TM	☆	★	☆	★	☆	☆	★	☆	★	☆	★	☆	☆	☆	☆	★	☆	☆	☆	★	7°
	H	4.00	0.80	0.80	QD-NH-0400-0008-TM	☆	★	☆	★	☆	☆	★	☆	★	☆	★	☆	☆	☆	☆	★	☆	☆	☆	★	7°
	J	5.00	0.40	0.40	QD-NJ-0500-0004-TM	☆	★	☆	★	☆	☆	★	☆	★	☆	★	☆	☆	☆	☆	★	☆	☆	☆	★	7°
	K	6.00	0.40	0.40	QD-NK-0600-0004-TM	☆	★	☆	★	☆	☆	★	☆	★	☆	★	☆	☆	☆	☆	★	☆	☆	☆	★	7°

D

E

SSC = Para corresponder ao SSC no suporte.

N = neutra

Tolerâncias:	CWTOLL	CWTOLU	RETOLL	RETOLU
QD-N..-TF	-0.050	0.050	-0.05	0.05
QD-N..-TM	-0.050	0.050	-0.05	0.05

F

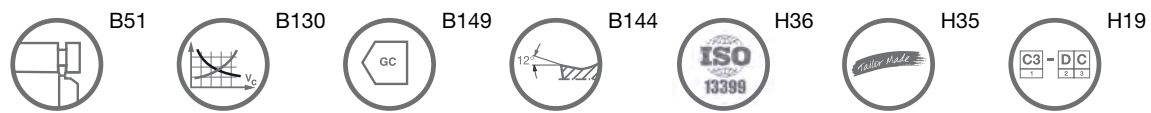

G

H



Pastilha CoroCut® QD para perfilamento

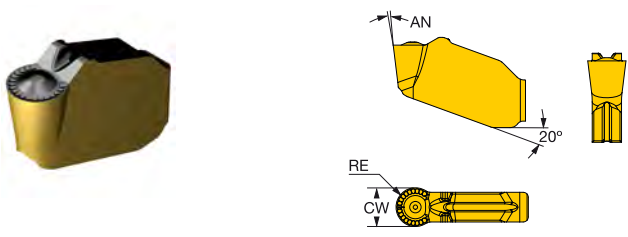

				Dimensões, mm												
				P		M		K		N		S		AN		
SSC	CW	RE	Código para pedido	1125	1135	4335	1125	1135	1125	1135	4335	1125	1135	1125	1135	
G	3.00	1.50	QD-NG-0300-RM	☆	★	☆	☆	★	★	☆	☆	★	★	☆	☆	7°
H	4.00	2.00	QD-NH-0400-RM	☆	★	☆	☆	★	★	☆	☆	★	★	☆	☆	7°
K	6.00	3.00	QD-NK-0600-RM	☆	★	☆	☆	★	★	☆	☆	★	★	☆	☆	7°
L	8.00	4.00	QD-NL-0800-RM	☆	★	☆	☆	★	★	☆	☆	★	★	☆	☆	7°

SSC = Para corresponder ao SSC no suporte. N = neutra

D Tolerâncias:

	CWTOLL	CWTOLU
QD-N..-RM	-0.050	0.050

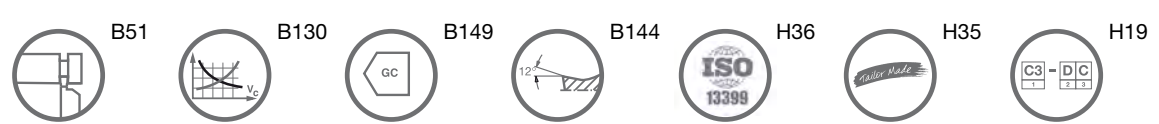

Unidade de corte CoroCut® QD para cortes e canais

Trava por mecanismo tipo mola

Refrigeração de precisão

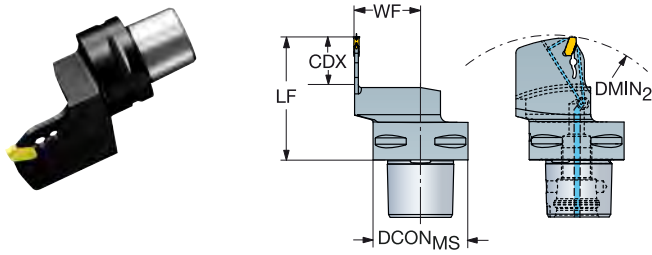

SSC	CZC _{MS}	CDX	DMIN ₂	CNSC	Código para pedido	Dimensões, mm					MIID
						DCON _{MS}	LF	WF	BAR	KG	
E	C3	22.0	133.0	3	C3-QD-R/LFE22C22055A	32	55.0	22.0	150	0.21	QD-NE-0200-0002-CM
	C4	22.0	151.0	3	C4-QD-R/LFE22C27060A	40	60.0	27.0	150	0.43	QD-NE-0200-0002-CM
F	C3	25.0	133.0	3	C3-QD-R/LFF25C22055A	32	55.0	22.0	150	0.20	QD-NF-0250-0002-CM
	C4	25.0	151.0	3	C4-QD-R/LFF25C27060A	40	60.0	27.0	150	0.41	QD-NF-0250-0002-CM
	C5	25.0	170.0	3	C5-QD-RFF25C35065A	50	65.0	35.0	150	0.71	QD-NF-0250-0002-CM
G	C3	25.0	133.0	3	C3-QD-RFG25C22055A	32	55.0	22.0	150	0.25	QD-NG-0300-0002-CM
	C4	25.0	151.0	3	C4-QD-R/LFG25C27060A	40	60.0	27.0	150	0.42	QD-NG-0300-0002-CM
	C5	25.0	170.0	3	C5-QD-R/LFG25C35065A	50	65.0	35.0	150	0.71	QD-NG-0300-0002-CM
	C6	25.0	97.0	3	C6-QD-R/LFG25C45070A	63	70.0	45.0	150	1.21	QD-NG-0300-0002-CM
H	C4	32.0	161.0	3	C4-QD-R/LFH32C27070A	40	70.0	27.0	150	0.40	QD-NH-0400-0002-CM
	C5	32.0	175.0	3	C5-QD-R/LFH32C35070A	50	70.0	35.0	150	0.70	QD-NH-0400-0002-CM
	C6	32.0	202.0	3	C6-QD-R/LFH32C45075A	63	75.0	45.0	150	1.19	QD-NH-0400-0002-CM
J	C4	32.0	161.0	3	C4-QD-LFJ32C27070A	40	70.0	27.0	150	0.52	QD-NJ-0500-0002-CM
	C5	32.0	175.0	3	C5-QD-R/LFJ32C35070A	50	70.0	35.0	150	0.63	QD-NJ-0500-0002-CM
	C6	32.0	202.0	3	C6-QD-LFJ32C45075A	63	75.0	45.0	150	1.20	QD-NJ-0500-0002-CM
K	C4	32.0	161.0	3	C4-QD-RFK32C27070A	40	70.0	27.0	150	0.46	QD-NK-0600-0003-CM
	C5	32.0	175.0	3	C5-QD-R/LFK32C35070A	50	70.0	35.0	175	0.70	QD-NK-0600-0003-CM
	C6	40.0	212.0	3	C6-QD-R/LFK40C45085A	63	85.0	45.0	150	1.27	QD-NK-0600-0003-CM
L	C8	38.0	241.0	3	C8-QD-LFL38C51090A	80	90.0	51.0	150	2.31	QD-NL-0800-0004-CM

SSC = Para corresponder ao SSC na pastilha.

R = versão direita, L = versão esquerda

Para componentes, visite www.sandvik.coromant.com



Ferramenta convencional CoroCut® QD para cortes e canais

Trava por mecanismo tipo mola

Refrigeração de precisão

TSYC QD-R/LF..C..A

QD-R/LF..C..D

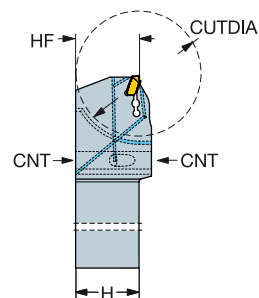
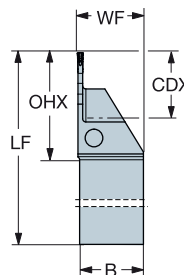
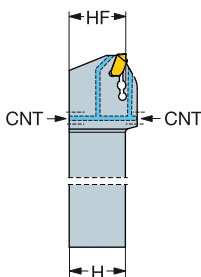
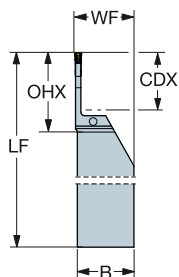

		Dimensões, mm														
SSC	CZC _{MS}	CDX	OHX	CNSC	Código para pedido	B	H	LF	WF	HF	CUTDIA	CNT	BAR	KG	MIID	
	H	32 x 32	33.0	55.0	2	QD-R/LFH33C3232A	32.0	32.0	170.0	33.0	32.0		G 1/8-28	150	1.13	QD-NH-0400-0002-CM
		32 x 32	45.0	66.0	2	QD-R/LFH45C3232A	32.0	32.0	170.0	33.0	32.0		G 1/8-28	150	1.08	QD-NH-0400-0002-CM
	J	32 x 32	33.0	54.0	2	QD-R/LFJ33C3232A	32.0	32.0	170.0	33.0	32.0		G 1/8-28	150	1.13	QD-NJ-0500-0002-CM
		32 x 32	45.0	66.0	2	QD-R/LFJ45C3232A	32.0	32.0	170.0	33.0	32.0		G 1/8-28	150	1.09	QD-NJ-0500-0002-CM
	K	32 x 32	33.0	55.0	2	QD-R/LFK33C3232A	32.0	32.0	170.0	33.0	32.0		G 1/8-28	150	1.13	QD-NK-0600-0003-CM
		32 x 32	45.0	67.0	2	QD-R/LFK45C3232A	32.0	32.0	170.0	33.0	32.0		G 1/8-28	150	1.08	QD-NK-0600-0003-CM
		40 x 40	60.0	83.1	2	QD-R/LFK60C4040A	40.0	40.0	250.0	40.3	40.0		G 1/8-28	150	2.52	QD-NK-0600-0003-CM
	L	32 x 32	45.0	70.0	2	QD-R/LFL45C3232A	32.0	32.0	170.0	32.3	32.0		G 1/8-28	150	1.13	QD-NL-0800-0004-CM
		40 x 40	65.0	90.0	2	QD-R/LFL65C4040A	40.0	40.0	250.0	40.3	40.0		G 1/8-28	150	2.52	QD-NL-0800-0004-CM
	G	32 x 32	33.0	54.0	2	QD-R/LFG33C3232D	32.0	32.0	170.0	33.0	32.0	66	G 1/8-28	150	1.17	QD-NG-0300-0002-CM

SSC = Para corresponder ao SSC na pastilha.

R = versão direita, L = versão esquerda

		Componentes
SSC	CZC _{MS}	Plugue de refrigeração
G	32 x 32	5643 018-01
H	32 x 32	5643 018-01
J	32 x 32	5643 018-01
K	32 x 32	5643 018-01
K	40 x 40	3214 012-01
L	32 x 32-40 x 40	3214 012-01

Para a lista completa de componentes, acesse www.sandvik.coromant.com



Ferramenta convencional CoroCut® QD para cortes e canais

Trava por mecanismo tipo mola

TSYC QD-R/LF..A

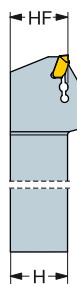
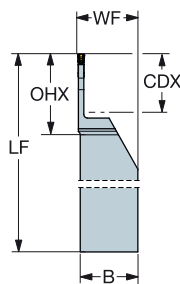

QD-R/LF..S

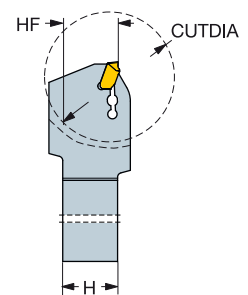
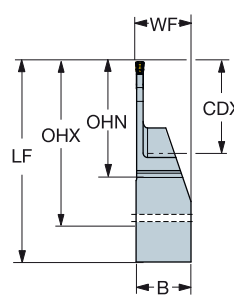

SSC	CZC _{MS}	CDX	OHX	OHN	Código para pedido	Dimensões, mm						MIID	
						B	H	LF	WF	HF	CUTDIA		(KG)
E	25 x 25	20.0	29.0		QD-R/LFE20-2525A	25.0	25.0	150.0	25.3	25.0		0.67	QD-NE-0200-0002-CM
F	25 x 25	26.0	35.0		QD-R/LFF26-2525A	25.0	25.0	150.0	25.3	25.0		0.65	QD-NF-0250-0002-CM
G	25 x 25	26.0	36.0		QD-R/LFG26-2525A	25.0	25.0	150.0	25.3	25.0		0.65	QD-NG-0300-0002-CM
H	25 x 25	33.0	42.0		QD-R/LFH33-2525A	25.0	25.0	150.0	25.3	25.0		0.62	QD-NH-0400-0002-CM
B	16 x 16	10.0	25.0	25.0	QD-R/LFB10-1616S	16.0	16.0	125.0	16.0	16.0	20	0.24	QD-NB-0100-0001-CM
	20 x 20	10.0	25.0	25.0	QD-R/LFB10-2020S	20.0	20.0	125.0	20.0	20.0	20	0.37	QD-NB-0100-0001-CM
C	16 x 16	13.0	26.1	26.1	QD-R/LFC13-1616S	16.0	16.0	125.0	16.0	16.0	26	0.24	QD-NC-0125-0001-CM
	20 x 20	13.0	25.0	25.0	QD-R/LFC13-2020S	20.0	20.0	125.0	20.0	20.0	26	0.37	QD-NC-0125-0001-CM
D	16 x 16	16.0	25.0	25.0	QD-R/LFD16-1616S	16.0	16.0	125.0	16.0	16.0	32	0.24	QD-ND-0150-0001-CM
	20 x 20	16.0	25.0	25.0	QD-R/LFD16-2020S	20.0	20.0	125.0	20.0	20.0	32	0.37	QD-ND-0150-0001-CM
E	16 x 16	20.0	29.0		QD-R/LFE20-1616S	16.0	16.0	125.0	16.0	16.0	40	0.25	QD-NE-0200-0002-CM
	20 x 20	26.0	35.0		QD-R/LFE26-2020S	20.0	20.0	125.0	20.0	20.0	52	0.36	QD-NE-0200-0002-CM
F	16 x 16	20.0	29.0		QD-R/LFF20-1616S	16.0	16.0	125.0	16.0	16.0	40	0.25	QD-NF-0250-0002-CM
	20 x 20	26.0	35.0		QD-R/LFF26-2020S	20.0	20.0	125.0	20.0	20.0	52	0.37	QD-NF-0250-0002-CM
G	16 x 16	20.0	29.0		QD-R/LFG20-1616S	16.0	16.0	125.0	16.0	16.0	40	0.25	QD-NG-0300-0002-CM
	20 x 20	33.0	42.0		QD-R/LFG33-2020S	20.0	20.0	125.0	20.0	20.0	66	0.35	QD-NG-0300-0002-CM
H	20 x 20	33.0	42.0		QD-R/LFH33-2020S	20.0	20.0	125.0	20.0	20.0	66	0.35	QD-NH-0400-0002-CM

SSC = Para corresponder ao SSC na pastilha.

R = versão direita, L = versão esquerda

Para componentes, visite www.sandvik.coromant.com



B51



F2



E1



H36



H35



H21



Ferramenta convencional CoroCut® QD e QS para cortes e canais

Trava por mecanismo tipo mola

Refrigeração de precisão

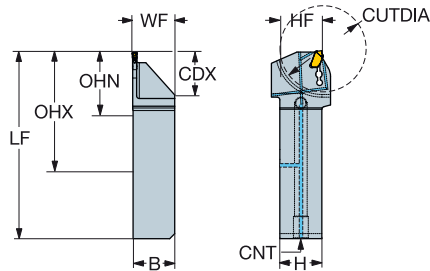
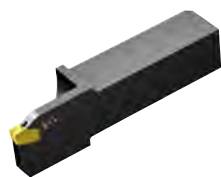

SSC	CZC _{MS}	CDX	OHX	OHN	CNSC	Código para pedido	Dimensões, mm							BAR	KG	MIID
							B	H	LF	WF	HF	CUTDIA	CNT			
D	20 x 20	16.0	45.0	25.0	3	QS-QD-R/LFD16C2020D	20.0	20.0	88.7	20.0	20.0	32	G 1/8-28	150	0.24	QD-ND-0150-0001-CM
E	20 x 20	20.0	41.6	21.6	3	QS-QD-R/LFE20C2020D	20.0	20.0	90.6	20.5	20.0	40	G 1/8-28	150	0.25	QD-NE-0200-0002-CM
	25 x 25	26.0	52.6	27.6	3	QS-QD-R/LFE26C2525D	25.0	25.0	111.6	26.0	25.0	52	G 1/8-28	150	0.16	QD-NE-0200-0002-CM
F	20 x 20	26.0	41.6	21.6	3	QS-QD-R/LFF26C2020D	20.0	20.0	90.6	20.5	20.0	40	G 1/8-28	150	0.26	QD-NF-0250-0002-CM
	25 x 25	26.0	52.6	27.6	3	QS-QD-R/LFF26C2525D	25.0	25.0	111.6	26.0	25.0	52	G 1/8-28	150	0.47	QD-NF-0250-0002-CM
G	20 x 20	26.0	41.6	21.6	3	QS-QD-R/LFG26C2020D	20.0	20.0	90.6	20.5	20.0	52	G 1/8-28	150	0.26	QD-NG-0300-0002-CM
	25 x 25	26.0	52.6	27.6	3	QS-QD-R/LFG26C2525D	25.0	25.0	111.6	26.0	25.0	52	G 1/8-28	150	0.47	QD-NG-0300-0002-CM
H	20 x 20	33.0	54.6	34.6	3	QS-QD-R/LFH33C2020D	20.0	20.0	103.6	20.5	20.0	66	G 1/8-28	150	0.26	QD-NH-0400-0002-CM
	25 x 25	40.0	46.6	41.6	3	QS-QD-R/LFH40C2525D	25.0	25.0	125.6	25.5	25.0	80	G 1/8-28	150	0.49	QD-NH-0400-0002-CM
J	25 x 25	40.0	66.6	41.6	3	QS-QD-R/LFJ40C2525D	25.0	25.0	125.6	25.5	25.0	80	G 1/8-28	150	0.50	QD-NJ-0500-0002-CM
	K	25 x 25	40.0	66.6	41.6	3	QS-QD-R/LFK40C2525D	25.0	25.0	125.6	25.5	25.0	80	G 1/8-28	150	0.49

SSC = Para corresponder ao SSC na pastilha.

R = versão direita, L = versão esquerda

Componentes	
Plugue 3214 013-01	Plugue 3214 012-01

Para a lista completa de componentes, acesse www.sandvik.coromant.com



Lâmina CoroCut® QD para cortes

Trava por mecanismo tipo mola

Acoplamento neutro - Refrigeração de precisão

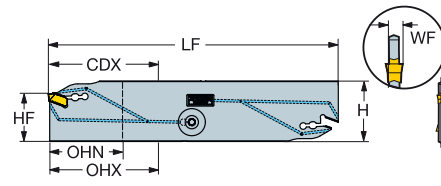
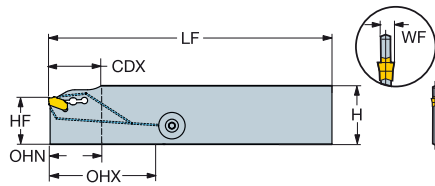

Lâmina de corte com aresta única

SSC	CZC _{MS}	CDX	OHX	OHN	CNSC	Código para pedido	Dimensões, mm					MIID	
							H	LF	WF	HF	BAR		KG
E	25	26.0	26.0	17.0	2	QD-NR1E26C25A	31.9	150.0	1.8	25.0	70	0.12	QD-NE-0200-0002-CM
F	25	33.0	33.0	17.0	2	QD-NR1F33C25A	31.9	150.0	2.3	25.0	70	1.22	QD-NF-0250-0002-CM
G	25	60.0	60.0	17.0	2	QD-NN1G60C25A	31.9	150.0	2.7	25.0	70	0.13	QD-NG-0300-0002-CM
H	21	36.0	36.0	17.0	2	QD-NN1H36C21A	25.9	110.0	3.7	21.4	70	0.11	QD-NH-0400-0002-CM
	25	60.0	60.0	17.0	2	QD-NN1H60C25A	31.9	150.0	3.7	25.0	70	0.16	QD-NH-0400-0002-CM

Lâmina de corte com dupla extremidade

SSC	CZC _{MS}	CDX	OHX	OHN	CNSC	Código para pedido	Dimensões, mm					MIID	
							H	LF	WF	HF	BAR		KG
D	25	16.0	50.0	18.0	2	QD-NR2D16C25A	31.9	150.0	2.5	25.0	70	0.10	QD-ND-0150-0001-CM
E	25	26.0	60.0	26.0	2	QD-NR2E26C25A	31.9	150.0	2.6	25.0	70	0.12	QD-NE-0200-0002-CM
F	25	33.0	50.0	33.0	2	QD-NR2F33C25A	31.9	150.0	2.6	25.0	70	0.11	QD-NF-0250-0002-CM
G	21	36.0	36.0	19.0	2	QD-NN2G36C21A	25.9	110.0	2.7	21.4	70	0.09	QD-NG-0300-0002-CM
	25	60.0	60.0	20.0	2	QD-NN2G60C25A	31.9	150.0	2.7	25.0	70	0.12	QD-NG-0300-0002-CM
H	45	80.0	80.0	30.0	2	QD-NN2G80C45A	52.5	225.0	2.7	45.0	70	0.30	QD-NG-0300-0002-CM
	25	60.0	60.0	20.0	2	QD-NN2H60C25A	31.9	150.0	3.7	25.0	70	0.15	QD-NH-0400-0002-CM
J	45	80.0	80.0	30.0	2	QD-NN2H80C45A	52.5	225.0	3.7	45.0	70	0.38	QD-NH-0400-0002-CM
	25	60.0	60.0	25.0	2	QD-NN2J60C25A	31.9	150.0	4.7	25.0	70	0.17	QD-NJ-0500-0002-CM
K	45	80.0	80.0	30.0	2	QD-NN2J80C45A	52.5	225.0	4.7	45.0	70	0.45	QD-NJ-0500-0002-CM
	25	60.0	60.0	24.0	2	QD-NN2K60C25A	31.9	150.0	5.7	25.0	70	0.20	QD-NK-0600-0003-CM
L	45	80.0	80.0	30.0	2	QD-NN2K80C45A	52.5	225.0	5.7	45.0	70	0.53	QD-NK-0600-0003-CM
	45	80.0	80.0	25.0	2	QD-NN2L80C45A	52.5	225.0	7.7	45.0	70	0.67	QD-NL-0800-0004-CM

SSC = Para corresponder ao SSC na pastilha.

N = Neutra, R = Versão direita

		Componentes	
SSC	CZC _{MS}	Plugue de refrigeração	Plugue
D,E,F	25	5643 028-01	5645 040-01
G	21	5643 028-01	5645 040-02
G	25-45	5643 028-01	5645 040-01
H,J,K,L	21-45	5643 028-01	5645 040-01

Para a lista completa de componentes, acesse www.sandvik.coromant.com



B51



F2



E1



H36



H35



H20



H5

Lâmina CoroCut® QD para cortes

Trava por mecanismo tipo mola

Acoplamento neutro - Refrigeração de precisão

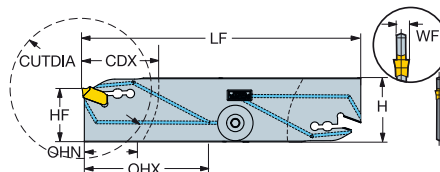
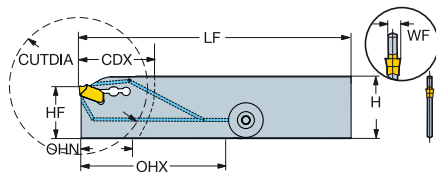

Lâmina de corte com extremidade única e reforço curvo

SSC	CZC _{MS}	CDX	OHX	OHN	CNSC	Código para pedido	Dimensões, mm						MIID	
							H	LF	WF	HF	CUTDIA	BAR		KG
F	21	33.0	36.0	33.0	2	QD-NR1F33C21D	25.9	110.0	2.6	21.4	66	70	0.09	QD-NF-0250-0002-CM

Lâmina de corte com dupla extremidade e reforço curvo

SSC	CZC _{MS}	CDX	OHX	OHN	CNSC	Código para pedido	Dimensões, mm						MIID	
							H	LF	WF	HF	CUTDIA	BAR		KG
B	21	10.0	36.0	18.0	2	QD-NR2B10C21D	25.9	110.0	2.5	21.4	20	70	0.08	QD-NB-0100-0001-CM
C	21	13.0	36.0	18.0	2	QD-NR2C13C21D	25.9	110.0	2.5	21.4	26	70	0.07	QD-NC-0125-0001-CM
D	21	16.0	36.0	18.0	2	QD-NR2D16C21D	25.9	110.0	2.5	21.4	32	70	0.07	QD-ND-0150-0001-CM
E	21	26.0	36.0	26.0	2	QD-NR2E26C21D	25.9	110.0	2.6	21.4	52	70	0.08	QD-NE-0200-0002-CM

SSC = Para corresponder ao SSC na pastilha.

R = versão direita

SSC	CZC _{MS}	Componentes	
		Plugue de refrigeração	Plugue
B	21	5643 028-03	5645 040-01
C	21	5643 028-03	5645 040-01
D	21	5643 028-03	5645 040-01
E	21	5643 028-03	5645 040-02

Para a lista completa de componentes, acesse www.sandvik.coromant.com



B51



F2



E1



H36



H35



H20



H5

Lâmina CoroCut® QD para cortes

Trava por mecanismo tipo mola

Acoplamento versão direita - Refrigeração de precisão

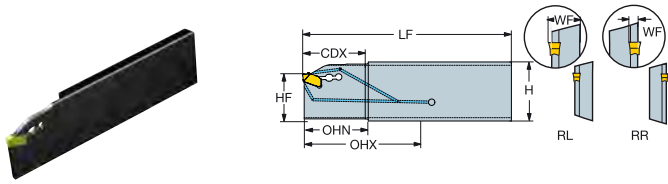

Lâmina de corte com extremidade única e reforço linear

SSC	CZC _{MS}	CDX	OHX	OHN	CNSC	Código para pedido	Dimensões, mm						MIID
							H	LF	WF	HF	BAR	KG	
E	25L	26.0	26.0	17.0	2	QD-RL1E26C25A	31.9	110.0	8.3	25.0	70	0.19	QD-NE-0200-0002-CM
	25L	26.0	50.0	26.0	2	QD-RR1E26C25A	31.9	110.0	1.8	25.0	70	0.20	QD-NE-0200-0002-CM
F	25L	33.0	33.0	17.0	2	QD-RL1F33C25A	31.9	110.0	8.3	25.0	70	0.19	QD-NF-0250-0002-CM
	25L	33.0	50.0	33.0	2	QD-RR1F33C25A	31.9	110.0	2.3	25.0	70	0.19	QD-NF-0250-0002-CM
G	25L	33.0	50.0	33.0	2	QD-RL1G33C25A	31.9	110.0	8.3	25.0	70	0.19	QD-NG-0300-0002-CM
	25L	33.0	50.0	33.0	2	QD-RR1G33C25A	31.9	110.0	2.7	25.0	70	0.19	QD-NG-0300-0002-CM
H	25L	40.0	40.0	17.0	2	QD-RL1H40C25A	31.9	110.0	8.3	25.0	70	0.19	QD-NH-0400-0002-CM
	25L	40.0	50.0	40.0	2	QD-RR1H40C25A	31.9	110.0	3.7	25.0	70	0.19	QD-NH-0400-0002-CM

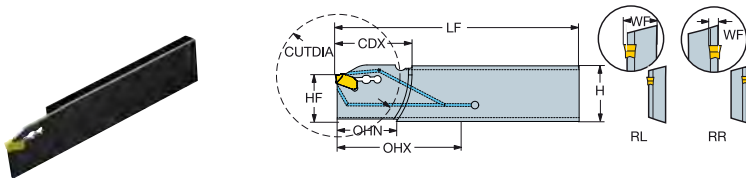

Lâmina de corte com extremidade única e reforço curvo

SSC	CZC _{MS}	CDX	OHX	OHN	CNSC	Código para pedido	Dimensões, mm						MIID	
							H	LF	WF	HF	CUTDIA	BAR		KG
E	21L	26.0	26.0	17.0	2	QD-RL1E26C21D	25.9	110.0	8.3	21.4	52	70	0.17	QD-NE-0200-0002-CM
	21L	26.0	50.0	26.0	2	QD-RR1E26C21D	25.9	110.0	1.8	21.4	52	70	0.17	QD-NE-0200-0002-CM
F	21L	26.0	26.0	17.0	2	QD-RL1F26C21D	25.9	110.0	8.3	21.4	52	70	0.17	QD-NF-0250-0002-CM
	21L	33.0	50.0	33.0	2	QD-RL1G33C21D	25.9	110.0	8.3	21.4	66	70	0.17	QD-NG-0300-0002-CM
G	21L	26.0	50.0	26.0	2	QD-RR1G26C21D	25.9	110.0	2.7	21.4	52	70	0.17	QD-NG-0300-0002-CM
	21L	33.0	50.0	33.0	2	QD-RR1G33C21D	25.9	110.0	2.7	21.4	66	70	0.14	QD-NG-0300-0002-CM

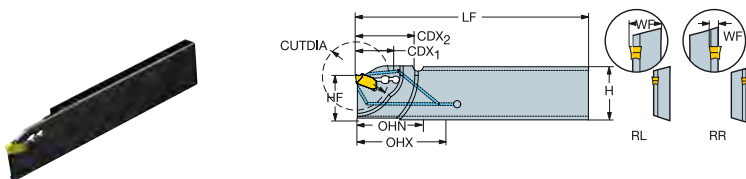

Lâmina de corte com extremidade única e duas curvas reforçadas

SSC	CZC _{MS}	CDX ₁	CDX ₂	OHX	OHN	CNSC	Código para pedido	Dimensões, mm						MIID	
								H	LF	WF	HF	CUTDIA	BAR		KG
D	21L	18.0	28.0	45.0	21.0	2	QD-RL1D18C21D2	25.9	110.0	2.5	21.4	36	70	0.16	QD-ND-0150-0001-CM
	21L	18.0	28.0	45.0	21.0	2	QD-RR1D18C21D2	25.9	110.0	2.5	21.4	36	70	0.16	QD-ND-0150-0001-CM
E	21L	18.0	28.0	50.0	18.0	2	QD-RL1E18C21D2	25.9	110.0	8.3	21.4	36	70	0.17	QD-NE-0200-0002-CM
	21L	18.0	28.0	50.0	18.0	2	QD-RR1E18C21D2	25.9	110.0	1.8	21.4	36	70	0.17	QD-NE-0200-0002-CM
G	21L	18.0	28.0	50.0	18.0	2	QD-RL1G18C21D2	25.9	110.0	8.3	21.4	36	70	0.17	QD-NG-0300-0002-CM
	21L	18.0	28.0	50.0	18.0	2	QD-RR1G18C21D2	25.9	110.0	2.7	21.4	36	70	0.17	QD-NG-0300-0002-CM

SSC = Para corresponder ao SSC na pastilha.

R = versão direita, L = versão esquerda

Para máquinas com subspindle.

Para componentes, visite www.sandvik.coromant.com



B51



F2



E1



H36



H35



H20



H5

Lâmina CoroCut® QD para cortes

Trava por mecanismo tipo mola

Acoplamento versão esquerda - Refrigeração de precisão

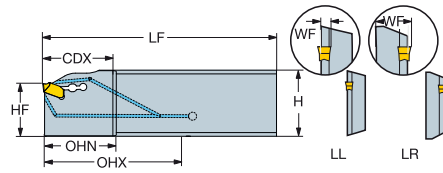

Lâmina de corte com extremidade única e reforço linear

SSC	CZC _{MS}	CDX	OHX	OHN	CNSC	Código para pedido	Dimensões, mm					BAR	KG	MIID
							H	LF	WF	HF				
E	25R	26.0	50.0	26.0	2	QD-LL1E26C25A	31.9	110.0	1.8	25.1	70	0.20	QD-NE-0200-0002-CM	
	25R	26.0	50.0	26.0	2	QD-LR1E26C25A	31.9	110.0	8.3	25.0	70	0.19	QD-NE-0200-0002-CM	
F	25R	33.0	50.0	33.0	2	QD-LL1F33C25A	31.9	110.0	2.3	25.1	70	0.19	QD-NF-0250-0002-CM	
	25R	33.0	50.0	33.0	2	QD-LR1F33C25A	31.9	110.0	8.3	25.0	70	0.19	QD-NF-0250-0002-CM	
G	25R	33.0	50.0	33.0	2	QD-LL1G33C25A	31.9	110.0	2.7	25.1	70	0.19	QD-NG-0300-0002-CM	
	25R	33.0	50.0	33.0	2	QD-LR1G33C25A	31.9	110.0	8.3	25.1	70	0.19	QD-NG-0300-0002-CM	
H	25R	40.0	50.0	40.0	2	QD-LL1H40C25A	31.9	110.0	3.7	25.1	70	0.19	QD-NH-0400-0002-CM	
	25R	40.0	50.0	40.0	2	QD-LR1H40C25A	31.9	110.0	8.3	25.0	70	0.19	QD-NH-0400-0002-CM	

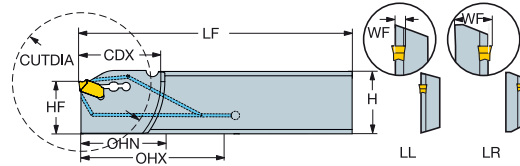

Lâmina de corte com extremidade única e reforço curvo

SSC	CZC _{MS}	CDX	OHX	OHN	CNSC	Código para pedido	Dimensões, mm					BAR	KG	MIID
							H	LF	WF	HF	CUTDIA			
E	21R	26.0	50.0	26.0	2	QD-LL1E26C21D	25.9	110.0	1.8	21.4	52	70	0.17	QD-NE-0200-0002-CM
	21R	26.0	26.0	17.0	2	QD-LR1E26C21D	25.9	110.0	8.3	21.4	52	70	0.17	QD-NE-0200-0002-CM
F	21R	26.0	50.0	26.0	2	QD-LL1F26C21D	25.9	110.0	2.3	21.4	52	70	0.17	QD-NF-0250-0002-CM
	21R	26.0	26.0	17.0	2	QD-LR1F26C21D	25.9	110.0	8.3	21.4	52	70	0.17	QD-NF-0250-0002-CM
G	21R	26.0	50.0	26.0	2	QD-LL1G26C21D	25.9	110.0	2.7	21.4	52	70	0.17	QD-NG-0300-0002-CM
	21R	33.0	50.0	33.0	2	QD-LL1G33C21D	25.9	110.0	2.7	21.4	66	70	0.16	QD-NG-0300-0002-CM
21R	33.0	50.0	33.0	2	QD-LR1G33C21D	25.9	110.0	8.3	21.4	66	70	0.16	QD-NG-0300-0002-CM	

SSC = Para corresponder ao SSC na pastilha.

R = versão direita, L = versão esquerda

Para componentes, visite www.sandvik.coromant.com



B51



F2



E1



ISO 13399



H36



H35



H20



H5

Lâmina CoroCut® QD para cortes

Trava por mecanismo tipo mola

Acoplamento neutro

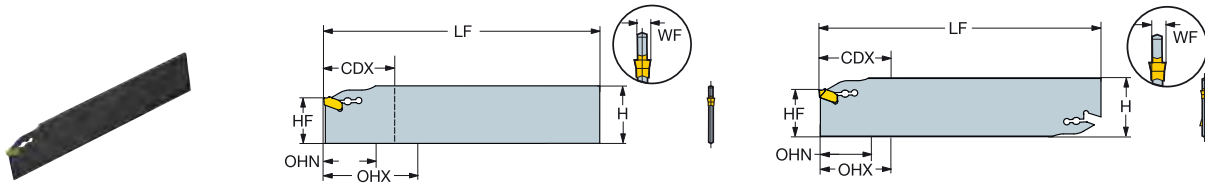

Lâmina de corte com aresta única

SSC	CZC _{MS}	CDX	OHX	OHN	Código para pedido	Dimensões, mm					MIID
						H	LF	WF	HF	KG	
E	25	26.0	26.0	17.0	QD-NR1E26-25A	31.9	150.0	1.8	25.0	0.11	QD-NE-0200-0002-CM
F	25	33.0	33.0	17.0	QD-NN1F33-25A	31.9	150.0	2.3	25.0	0.11	QD-NF-0250-0002-CM
G	25	60.0	60.0	17.0	QD-NN1G60-25A	31.9	150.0	2.7	25.0	0.12	QD-NG-0300-0002-CM
H	21	36.0	36.0	17.0	QD-NN1H36-21A	25.9	110.0	3.7	21.4	0.10	QD-NH-0400-0002-CM
	25	60.0	60.0	17.0	QD-NN1H60-25A	31.9	150.0	3.7	25.0	0.15	QD-NH-0400-0002-CM

Lâmina de corte com dupla extremidade

SSC	CZC _{MS}	CDX	OHX	OHN	Código para pedido	Dimensões, mm					MIID
						H	LF	WF	HF	KG	
E	25	26.0	50.0	26.0	QD-NR2E26-25A	31.9	150.0	2.6	25.0	0.11	QD-NE-0200-0002-CM
F	21	33.0	35.0	17.0	QD-NN2F33-21A	25.9	110.0	2.3	21.4	0.01	QD-NF-0250-0002-CM
	25	33.0	50.0	17.0	QD-NN2F33-25A	31.9	150.0	2.3	25.0	0.10	QD-NF-0250-0002-CM
G	21	36.0	36.0	17.0	QD-NN2G36-21A	25.9	110.0	2.7	21.4	0.08	QD-NG-0300-0002-CM
	25	60.0	60.0	17.0	QD-NN2G60-25A	31.9	150.0	2.7	25.0	0.12	QD-NG-0300-0002-CM
	45	80.0	80.0	30.0	QD-NN2G80-45A	52.5	225.0	2.7	45.0	0.30	QD-NG-0300-0002-CM
H	25	60.0	60.0	17.0	QD-NN2H60-25A	31.9	150.0	3.7	25.0	0.15	QD-NH-0400-0002-CM
	45	80.0	80.0	30.0	QD-NN2H80-45A	52.5	225.0	3.7	45.0	0.38	QD-NH-0400-0002-CM
L	45	80.0	80.0	25.0	QD-NN2L80-45A	52.5	225.0	7.7	45.0	0.70	QD-NL-0800-0004-CM

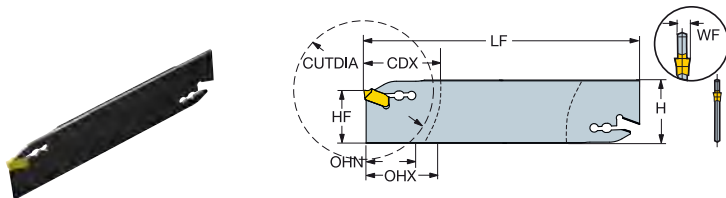

Lâmina de corte com dupla extremidade e reforço curvo

SSC	CZC _{MS}	CDX	OHX	OHN	Código para pedido	Dimensões, mm					MIID	
						H	LF	WF	HF	CUTDIA		KG
E	21	26.0	50.0	26.0	QD-NR2E26-21D	25.9	110.0	2.6	21.4	52	0.08	QD-NE-0200-0002-CM

SSC = Para corresponder ao SSC na pastilha.

N = Neutra, R = Versão direita

Para componentes, visite www.sandvik.coromant.com



B51



F2



E1



ISO
13399



H36



H35



H20



Lâmina CoroCut® QD para cortes

Trava por mecanismo tipo mola

Acoplamento versão direita

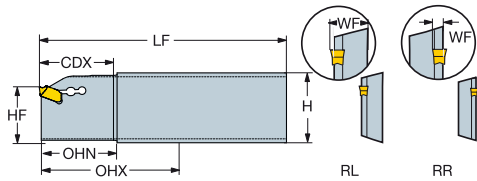

Lâmina de corte com extremidade única e reforço linear

						Dimensões, mm					
SSC	CZC _{MIS}	CDX	OHX	OHN	Código para pedido	H	LF	WF	HF	KG	MIID
G	25L	33.0	50.0	33.0	QD-RL1G33-25A	31.9	110.0	8.3	25.0	0.19	QD-NG-0300-0002-CM
	25L	33.0	50.0	33.0	QD-RR1G33-25A	31.9	110.0	2.7	25.0	0.20	QD-NG-0300-0002-CM



D

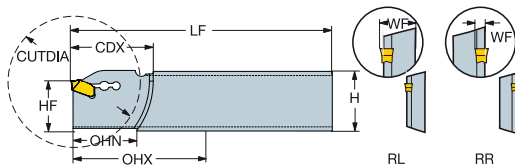

Lâmina de corte com extremidade única e reforço curvo

						Dimensões, mm						
SSC	CZC _{MIS}	CDX	OHX	OHN	Código para pedido	H	LF	WF	HF	CUTDIA	KG	MIID
G	21L	33.0	50.0	33.0	QD-RL1G33-21D	25.9	110.0	8.3	21.4	66	0.17	QD-NG-0300-0002-CM
	21L	26.0	50.0	26.0	QD-RR1G26-21D	25.9	110.0	2.7	21.4	52	0.17	QD-NG-0300-0002-CM
	21L	33.0	50.0	33.0	QD-RR1G33-21D	25.9	110.0	2.7	21.4	66	0.17	QD-NG-0300-0002-CM



F

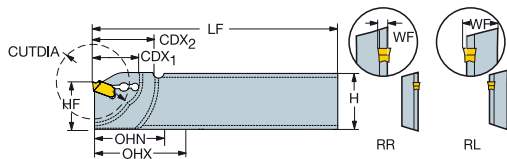

Lâmina de corte com extremidade única e duas curvas reforçadas

						Dimensões, mm							
SSC	CZC _{MIS}	CDX ₁	CDX ₂	OHX	OHN	Código para pedido	H	LF	WF	HF	CUTDIA	KG	MIID
E	21L	18.0	28.0	50.0	18.0	QD-RR1E18-21D2	25.9	110.0	1.8	21.4	36	0.17	QD-NE-0200-0002-CM
G	21L	18.0	28.0	50.0	18.0	QD-RR1G18-21D2	25.9	110.0	2.7	21.4	36	0.14	QD-NG-0300-0002-CM



SSC = Para corresponder ao SSC na pastilha.

R = versão direita, L = versão esquerda

Para componentes, visite www.sandvik.coromant.com

H



Lâmina CoroCut® QD para cortes

Trava por mecanismo tipo mola

Acoplamento versão esquerda

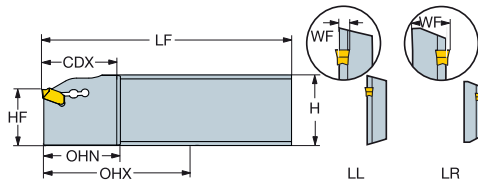

Lâmina de corte com extremidade única e reforço linear

						Dimensões, mm						
SSC	CZC _{MS}	CDX	OHX	OHN	Código para pedido	H	LF	WF	HF	KG	MIID	
G	25R	33.0	50.0	33.0	QD-LL1G33-25A	31.9	110.0	2.7	25.1	0.19	QD-NG-0300-0002-CM	
	25R	33.0	50.0	33.0	QD-LR1G33-25A	31.9	110.0	8.3	25.1	0.19	QD-NG-0300-0002-CM	

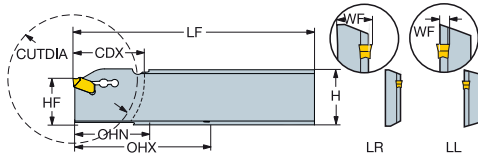

Lâmina de corte com extremidade única e reforço curvo

						Dimensões, mm						
SSC	CZC _{MS}	CDX	OHX	OHN	Código para pedido	H	LF	WF	HF	CUTDIA	KG	MIID
G	21R	26.0	50.0	26.0	QD-LL1G26-21D	25.9	110.0	2.7	21.4	52	0.17	QD-NG-0300-0002-CM
	21R	33.0	50.0	33.0	QD-LL1G33-21D	25.9	110.0	2.7	21.4	66	0.17	QD-NG-0300-0002-CM
	21R	33.0	50.0	33.0	QD-LR1G33-21D	25.9	110.0	8.3	21.4	66	0.17	QD-NG-0300-0002-CM

SSC = Para corresponder ao SSC na pastilha.

Para componentes, visite www.sandvik.coromant.com

R = versão direita, L = versão esquerda



B51



F2



E1



ISO
13399



H36



H35



H20



Cabeça CoroCut® QD para canais

Trava por mecanismo tipo mola

CoroTurn® SL - Refrigeração de precisão

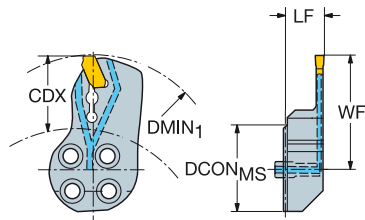

SSC	CZC _{MS}	CDX	DMIN ₁	CNSC	Código para pedido	Dimensões, mm						MID
						DCON _{MS}	LF	WF	HF	BAR	KG	
E	25	22.0	55.0	1	SL-QD-R/LGE22C25	25	9.0	36.1	0.1	80	0.07	QD-NE-0200-0002-CM
	32	26.0	64.0	1	SL-QD-R/LGE26C32	32	11.0	43.6	0.1	80	0.11	QD-NE-0200-0002-CM
F	25	22.0	65.0	1	SL-QD-R/GF22C25	25	9.0	36.1	0.1	80	0.07	QD-NF-0250-0002-CM
	32	26.0	65.0	1	SL-QD-R/LGF26C32	32	11.0	43.6	0.1	80	0.11	QD-NF-0250-0002-CM
G	25	22.0	70.0	1	SL-QD-R/LGG22C25	25	9.0	36.1	0.1	80	0.07	QD-NG-0300-0002-CM
	32	26.0	70.0	1	SL-QD-R/LGG26C32	32	11.0	43.6	0.1	80	0.11	QD-NG-0300-0002-CM
	40	32.0	80.0	1	SL-QD-R/LGG32C40	40	12.0	53.6	0.1	80	0.17	QD-NG-0300-0002-CM
H	32	32.0	75.0	1	SL-QD-R/LGH32C32	32	11.0	49.6	0.1	80	0.13	QD-NH-0400-0002-CM
	40	40.0	90.0	1	SL-QD-R/LGH40C40	40	12.0	61.6	0.1	80	0.19	QD-NH-0400-0002-CM
J	40	40.0	130.0	1	SL-QD-R/LGJ40C40	40	12.0	61.6	0.1	80	0.21	QD-NJ-0500-0002-CM
K	40	40.0	130.0	1	SL-QD-R/LGK40C40	40	12.0	61.6	0.1	80	0.21	QD-NK-0600-0003-CM

SSC = Para corresponder ao SSC na pastilha.

R = versão direita, L = versão esquerda

Componentes		
SSC	CZC _{MS}	Tubo de localização
E	25	5552 058-02
E	32	5638 031-01
F	25	5552 058-02
F	32	5638 031-01
G	25	5552 058-02
G	32-40	5638 031-01
H	32-40	5638 031-01
J	40	5638 031-01
K	40	5638 031-01

Para a lista completa de componentes, acesse www.sandvik.coromant.com



CoroCut® QF

Usinagem segura de canais frontais

Aplicação

- Canais frontais

Área de aplicação ISO:



Características e benefícios

- Cabeças de corte CoroTurn® SL para usinagem de canais frontais
- Refrigeração interna de alta precisão
- Ideal para trabalhar com pastilhas grandes
- A fácil fixação da pastilha garante a força de fixação correta
- Pastilhas desenvolvidas para rotação do fuso no sentido horário (QFT) e no sentido anti-horário (QFU)
- Folga lateral otimizada necessária para usinagem de canais frontais



www.sandvik.coromant.com/corocutf

Ferramentas

- Unidades de corte Coromant Capto®
- Ferramentas convencionais
- Ferramentas convencionais QS
- Cabeças CoroTurn® SL

Pastilhas

CW 3, 4, 6 e 8 mm (0,118, 0,157, 0,236 e 0,315 pol.)

Geometria da classe GC1105, GC1125, GC1135, GC1145, H10F

-TF para usinagem de canais e torneamento lateral geometria retificada

-GF para usinagem de canais

geometria -RM para perfilamento

Tailor Made

Ferramenta construída e otimizada com a profundidade de corte exata e a faixa de diâmetro necessária para sua peça.

Desenho inovador da lâmina

Mais material na seção transversal mais fraca e diminuição da massa na frente da lâmina oferece maior rigidez dinâmica, reduzindo efetivamente as vibrações. O canal foi otimizado para fornecer a força de fixação correta.

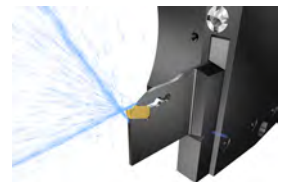

B51



B51



B51



H35

Pastilha CoroCut® QF para usinagem de canais frontais

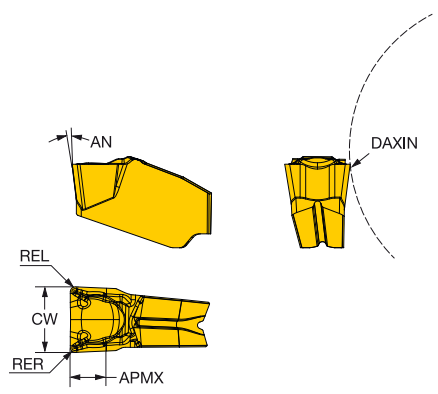

C

Acabamento	SSC	CW	REL	RER	DAXIN	Código para pedido	Dimensões, mm																				
							P				M				K		N			S			AN	CWTOLL	CWTOLU	RETOLL	RETOLU
							1105	1125	1135	1145	1105	1125	1135	1145	1125	1135	1105	1125	1135	1105	1125	1135					
QFT-G	3.00	0.30	0.30	30.0	QFT-G-0300-03-TF	☆	☆	★	☆	☆	☆	☆	☆	☆	☆	☆	☆	☆	☆	☆	☆	7°	-0.050	0.050	-0.050	0.050	
QFT-H	4.00	0.30	0.30	30.0	QFT-H-0400-03-TF	☆	☆	★	☆	☆	☆	☆	☆	☆	☆	☆	☆	☆	☆	☆	☆	7°	-0.050	0.050	-0.050	0.050	
QFT-K	6.00	0.40	0.40	45.0	QFT-K-0600-04-TF	☆	★	☆	☆	☆	☆	☆	☆	☆	☆	☆	☆	☆	☆	☆	☆	7°	-0.050	0.050	-0.050	0.050	
QFT-L	8.00	0.80	0.80	60.0	QFT-L-0800-08-TF	☆	★	☆	☆	☆	☆	☆	☆	☆	☆	★	☆	☆	☆	☆	☆	8°	-0.050	0.050	-0.050	0.050	

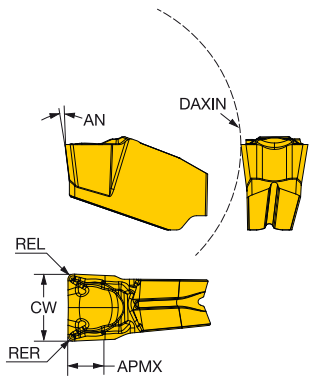

F

Acabamento	SSC	CW	REL	RER	DAXIN	Código para pedido	Dimensões, mm																				
							P				M				K		N			S			AN	CWTOLL	CWTOLU	RETOLL	RETOLU
							1105	1125	1135	1145	1105	1125	1135	1145	1125	1135	1105	1125	1135	1105	1125	1135					
QFU-G	3.00	0.30	0.30	30.0	QFU-G-0300-03-TF	☆	☆	★	☆	☆	☆	☆	☆	☆	☆	☆	☆	☆	☆	☆	☆	7°	-0.050	0.050	-0.050	0.050	
QFU-H	4.00	0.30	0.30	30.0	QFU-H-0400-03-TF	☆	☆	★	☆	☆	☆	☆	☆	☆	☆	☆	☆	☆	☆	☆	☆	7°	-0.050	0.050	-0.050	0.050	
QFU-K	6.00	0.40	0.40	45.0	QFU-K-0600-04-TF	☆	★	☆	☆	☆	☆	☆	☆	☆	☆	☆	☆	☆	☆	☆	7°	-0.050	0.050	-0.050	0.050		
QFU-L	8.00	0.80	0.80	60.0	QFU-L-0800-08-TF	☆	★	☆	☆	☆	☆	☆	☆	☆	☆	★	☆	☆	☆	☆	8°	-0.050	0.050	-0.050	0.050		

G SSC = Para corresponder ao SSC no suporte.

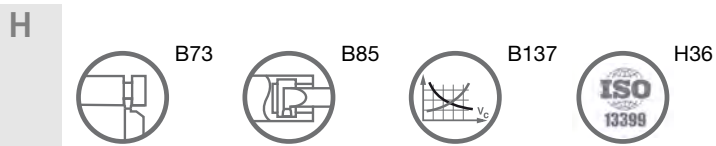

Pastilha CoroCut® QF para usinagem de canais frontais

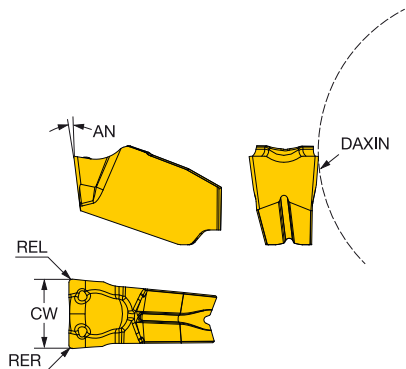

						P	M	K	N		S		Dimensões, mm										
						1125	1105	1125	1105	1125	H10F	1105	1125	H10F	AN	CWTOLL	CWTOLU	RETOLL	RETOLU				
Acabamento	SSC	CW	REL	RER	DAXIN	Código para pedido																	
	QFT-G	3.00	0.20	0.20	30.0	QFT-G-0300-02-GF	★	☆	★	★	☆	★	★	☆	7°	-0.020	0.020	-0.050	0.050				
	QFT-H	4.00	0.20	0.20	30.0	QFT-H-0400-02-GF	★	☆	★	★	☆	★	★	7°	-0.020	0.020	-0.050	0.050					

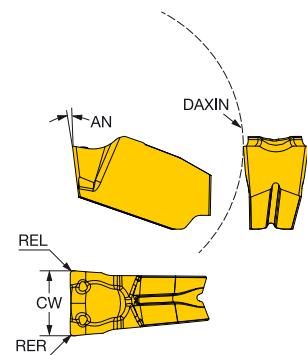

						P	M	K	N		S		Dimensões, mm										
						1125	1105	1125	1105	1125	H10F	1105	1125	H10F	AN	CWTOLL	CWTOLU	RETOLL	RETOLU				
Acabamento	SSC	CW	REL	RER	DAXIN	Código para pedido																	
	QFU-G	3.00	0.20	0.20	30.0	QFU-G-0300-02-GF	★	☆	★	★	☆	★	★	☆	7°	-0.020	0.020	-0.050	0.050				
	QFU-H	4.00	0.20	0.20	30.0	QFU-H-0400-02-GF	★	☆	★	★	☆	★	★	7°	-0.020	0.020	-0.050	0.050					

SSC = Para corresponder ao SSC no suporte.



B73



B85



B137



H36

Pastilha CoroCut® QF para usinagem de canais frontais

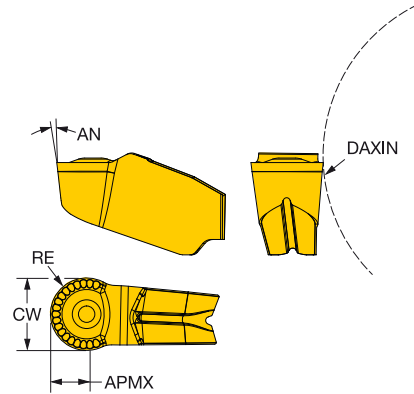

C

					P	M	K	N	S	Dimensões, mm									
Média	SSC	CW	RE	DAXIN	Código para pedido	1125	1135	1105	1125	1135	1105	1125	1105	1125	1135	AN	CWTOLL	CWTOLU	
	QFT-G	3.00	1.50	30.0	QFT-G-0300-RM	☆	★	☆	☆	☆	★	☆	☆	★	☆	☆	7°	-0.050	0.050
	QFT-H	4.00	2.00	30.0	QFT-H-0400-RM	☆	★	☆	☆	☆	★	☆	☆	★	☆	☆	7°	-0.050	0.050
	QFT-K	6.00	3.00	45.0	QFT-K-0600-RM	☆	★	☆	☆	☆	★	☆	☆	★	☆	☆	7°	-0.050	0.050

D

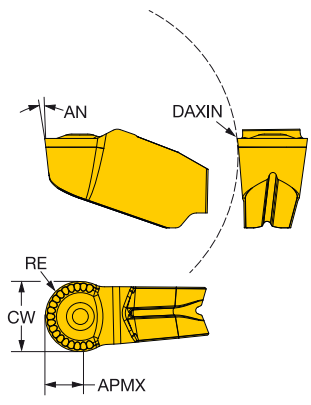

E

					P	M	K	N	S	Dimensões, mm									
Média	SSC	CW	RE	DAXIN	Código para pedido	1125	1135	1105	1125	1135	1105	1125	1105	1125	1135	AN	CWTOLL	CWTOLU	
	QFU-G	3.00	1.50	30.0	QFU-G-0300-RM	☆	★	☆	☆	☆	★	☆	☆	★	☆	☆	7°	-0.050	0.050
	QFU-H	4.00	2.00	30.0	QFU-H-0400-RM	☆	★	☆	☆	☆	★	☆	☆	★	☆	☆	7°	-0.050	0.050
	QFU-K	6.00	3.00	45.0	QFU-K-0600-RM	☆	★	☆	☆	☆	★	☆	☆	★	☆	☆	7°	-0.050	0.050

F

G

SSC = Para corresponder ao SSC no suporte.

H

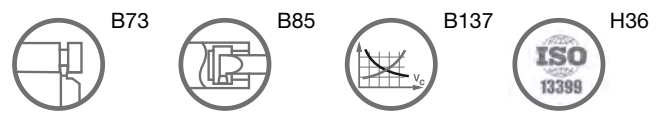

Unidade de corte CoroCut® QF para usinagem de canais frontais

Fixação por mecanismo tipo mola

Refrigeração de precisão

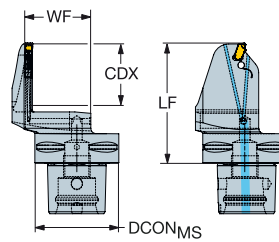

Curvatura B

SSC	CZC _{MS}	CDX	DAXIN	DAXX	CNSC	Código para pedido	Dimensões, mm					MIID	
							DCON _{MS}	LF	WF	BAR	KG		
QFT-K	C5	26.0	45.0	100.0	3	C5-QFT-RK26C-045B	50	61.6	33.0	150	0.68	QFT-K-0600-04-TF	
	C5	32.0	88.0	180.0	3	C5-QFT-RK32C-088B	50	67.6	33.0	150	0.68	QFT-K-0600-04-TF	
	C5	32.0	168.0	400.0	3	C5-QFT-RK32C-168B	50	67.6	33.0	150	0.71	QFT-K-0600-04-TF	
	C5	32.0	220.0	1000.0	3	C5-QFT-RK32C-220B	50	67.6	33.0	150	0.72	QFT-K-0600-04-TF	
	C6	26.0	45.0	100.0	3	C6-QFT-RK26C-045B	63	65.1	39.0	150	1.14	QFT-K-0600-04-TF	
	C6	32.0	88.0	180.0	3	C6-QFT-RK32C-088B	63	71.1	39.0	150	1.14	QFT-K-0600-04-TF	
	C6	32.0	168.0	400.0	3	C6-QFT-RK32C-168B	63	71.1	39.0	150	1.15	QFT-K-0600-04-TF	
	C6	32.0	220.0	1000.0	3	C6-QFT-RK32C-220B	63	71.1	39.0	150	1.14	QFT-K-0600-04-TF	
	C8	26.0	45.0	100.0	3	C8-QFT-RK26C-045B	80	73.1	42.0	150	2.14	QFT-K-0600-04-TF	
	C8	32.0	88.0	180.0	3	C8-QFT-RK32C-088B	80	79.1	42.0	150	2.14	QFT-K-0600-04-TF	
	C8	32.0	168.0	400.0	3	C8-QFT-RK32C-168B	80	79.1	42.0	150	1.14	QFT-K-0600-04-TF	
	C8	32.0	220.0	1000.0	3	C8-QFT-RK32C-220B	80	79.1	42.0	150	1.14	QFT-K-0600-04-TF	
	QFT-L	C6	33.0	60.0	150.0	3	C6-QFT-RL33C-060B	63	72.1	39.0	150	1.14	QFT-L-0800-08-TF
		C8	33.0	60.0	150.0	3	C8-QFT-RL33C-060B	80	80.1	42.0	150	2.14	QFT-L-0800-08-TF
C6		38.0	120.0	300.0	3	C6-QFT-RL38C-120B	63	77.1	39.0	150	2.14	QFT-L-0800-08-TF	
C6		50.0	220.0	1000.0	3	C6-QFT-RL50C-220B	63	89.1	39.0	150	1.23	QFT-L-0800-08-TF	
C8		38.0	120.0	300.0	3	C8-QFT-RL38C-120B	80	85.1	42.0	150	1.09	QFT-L-0800-08-TF	
C8		50.0	220.0	1000.0	3	C8-QFT-RL50C-220B	80	97.1	42.0	150	1.09	QFT-L-0800-08-TF	

SSC = Para corresponder ao SSC na pastilha.

R = versão direita

Para componentes, visite www.sandvik.coromant.com



Unidade de corte CoroCut® QF para usinagem de canais frontais

Fixação por mecanismo tipo mola

Refrigeração de precisão

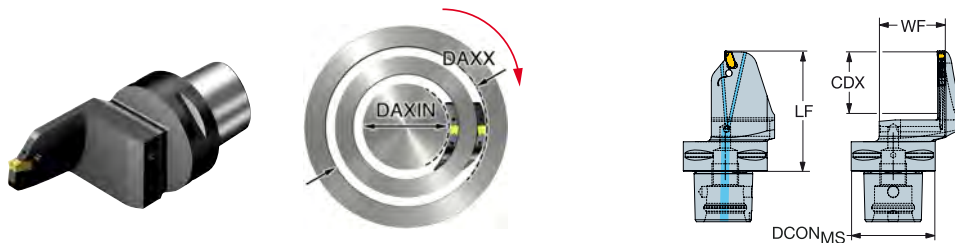

Curvatura B

SSC	CZC _{MS}	CDX	DAXIN	DAXX	CNSC	Código para pedido	Dimensões, mm					MIID
							DCON _{MS}	LF	WF	BAR	KG	
QFU-K	C5	26.0	45.0	100.0	3	C5-QFU-LK26C-045B	50	61.6	33.0	150	0.68	QFU-K-0600-04-TF
	C5	32.0	88.0	180.0	3	C5-QFU-LK32C-088B	50	67.6	33.0	150	0.68	QFU-K-0600-04-TF
	C5	32.0	168.0	400.0	3	C5-QFU-LK32C-168B	50	67.6	33.0	150	0.71	QFU-K-0600-04-TF
	C5	32.0	220.0	1000.0	3	C5-QFU-LK32C-220B	50	67.6	33.0	150	0.71	QFU-K-0600-04-TF
	C6	26.0	45.0	100.0	3	C6-QFU-LK26C-045B	63	65.1	39.0	150	1.14	QFU-K-0600-04-TF
	C6	32.0	88.0	180.0	3	C6-QFU-LK32C-088B	63	71.1	39.0	150	1.15	QFU-K-0600-04-TF
	C6	32.0	168.0	400.0	3	C6-QFU-LK32C-168B	63	71.1	39.0	150	2.14	QFU-K-0600-04-TF
	C6	32.0	220.0	1000.0	3	C6-QFU-LK32C-220B	63	71.1	39.0	150	1.15	QFU-K-0600-04-TF
	C8	26.0	45.0	100.0	3	C8-QFU-LK26C-045B	80	73.1	42.0	150	2.14	QFU-K-0600-04-TF
	C8	32.0	88.0	180.0	3	C8-QFU-LK32C-088B	80	79.1	42.0	150	2.14	QFU-K-0600-04-TF
	C8	32.0	168.0	400.0	3	C8-QFU-LK32C-168B	80	79.1	42.0	150	1.14	QFU-K-0600-04-TF
	C8	32.0	220.0	1000.0	3	C8-QFU-LK32C-220B	80	79.1	42.0	150	1.14	QFU-K-0600-04-TF
QFU-L	C6	33.0	60.0	150.0	3	C6-QFU-LL33C-060B	63	72.1	39.0	150	1.14	QFU-L-0800-08-TF
	C8	33.0	60.0	150.0	3	C8-QFU-LL33C-060B	80	80.1	42.0	150	2.14	QFU-L-0800-08-TF
	C6	38.0	120.0	300.0	3	C6-QFU-LL38C-120B	63	77.1	39.0	150	1.19	QFU-L-0800-08-TF
	C6	50.0	220.0	1000.0	3	C6-QFU-LL50C-220B	63	89.1	39.0	150	1.23	QFU-L-0800-08-TF
	C8	38.0	120.0	300.0	3	C8-QFU-LL38C-120B	80	85.1	42.0	150	1.09	QFU-L-0800-08-TF
	C8	50.0	220.0	1000.0	3	C8-QFU-LL50C-220B	80	97.1	42.0	150	2.21	QFU-L-0800-08-TF

SSC = Para corresponder ao SSC na pastilha.

L = versão esquerda

Para componentes, visite www.sandvik.coromant.com



Ferramenta convencional CoroCut® QF para usinagem de canais frontais

Fixação por mecanismo tipo mola

Refrigeração de precisão



Curvatura B

	SSC	CZC _{MS}	CDX	DAXIN	DAXX	OHX	CNCS	Código para pedido	Dimensões, mm								MIID	
									B	H	HBL	LF	WF	HF	CNT	BAR		KG
	QFT-K	32 x 32	32.0	80.0	200.0	18.0	3	QFT-LGK32C3232-080B	32.0	32.0	18.0	146.0	58.6	32.0	G 1/8-28	150	1.18	QFT-K-0600-04-TF
		32 x 32	32.0	200.0	1000.0	18.0	3	QFT-LGK32C3232-200B	32.0	32.0	18.0	146.0	58.6	32.0	G 1/8-28	150	1.00	QFT-K-0600-04-TF

SSC = Para corresponder ao SSC na pastilha.

Componentes	
Plugue	Plugue
3214 013-01	3214 012-01

Para a lista completa de componentes, acesse www.sandvik.coromant.com



A

Ferramenta convencional CoroCut® QF para usinagem de canais frontais

Fixação por mecanismo tipo mola

Refrigeração de precisão

B

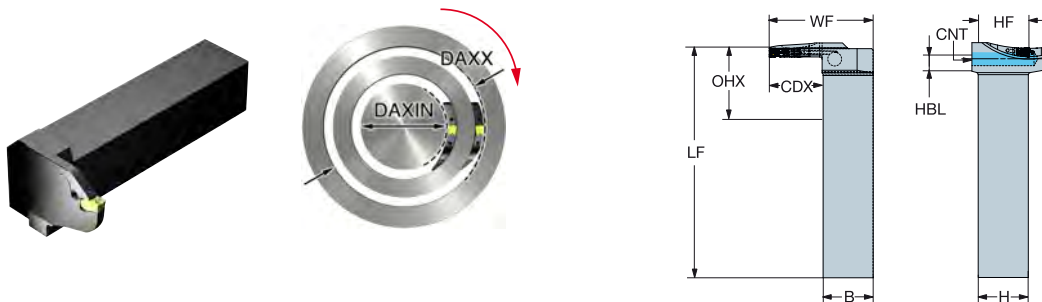

C

Curvatura B

SSC	CZC _{MS}	CDX	DAXIN	DAXX	OHX	CNCS	Código para pedido	Dimensões, mm							BAR	KG	MIID	
								B	H	HBL	LF	WF	HF	CNT				
	QFU-K	32 x 32	32.0	80.0	200.0	18.0	3	QFU-RGK32C3232-080B	32.0	32.0	18.0	146.0	58.6	32.0	G 1/8-28	150	1.18	QFU-K-0600-04-TF
		32 x 32	32.0	200.0	1000.0	18.0	3	QFU-RGK32C3232-200B	32.0	32.0	18.0	146.0	58.6	32.0	G 1/8-28	150	1.18	QFU-K-0600-04-TF

D

SSC = Para corresponder ao SSC na pastilha.

Componentes	
Plugue	Plugue
3214 013-01	3214 012-01

Para a lista completa de componentes, acesse www.sandvik.coromant.com

E

F

G

H



Ferramenta convencional CoroCut® QF para usinagem de canais frontais

Fixação por mecanismo tipo mola

Refrigeração de precisão



Curvatura B

								Código para pedido	Dimensões, mm								MIID	
	SSC	CZC _{MS}	CDX	DAXIN	DAXX	OHX	CNSC		B	H	HBL	LF	WF	HF	CNT	BAR		KG
	QFT-K	32 x 32	32.0	80.0	180.0	51.6	3	QFT-RFK32C3232-080B	32.0	32.0	51.6	170.0	33.0	32.0	G 1/8-28	150	1.18	QFT-K-0600-04-TF
		32 x 32	32.0	160.0	400.0	51.6	3	QFT-RFK32C3232-160B	32.0	32.0	51.6	170.0	33.0	32.0	G 1/8-28	150	1.18	QFT-K-0600-04-TF
		32 x 32	32.0	220.0	1000.0	51.6	3	QFT-RFK32C3232-220B	32.0	32.0	51.6	170.0	33.0	32.0	G 1/8-28	150	1.18	QFT-K-0600-04-TF
	QFT-L	32 x 32	33.0	60.0	150.0	52.6	3	QFT-RFL33C3232-060B	32.0	32.0	52.6	170.0	33.0	32.0	G 1/8-28	150	1.18	QFT-L-0800-08-TF
		32 x 32	38.0	120.0	300.0	57.6	3	QFT-RFL38C3232-120B	32.0	32.0	57.6	170.0	33.0	32.0	G 1/8-28	150	1.18	QFT-L-0800-08-TF
		32 x 32	50.0	220.0	1000.0	69.6	3	QFT-RFL50C3232-220B	32.0	32.0	69.6	170.0	33.0	32.0	G 1/8-28	150	1.09	QFT-L-0800-08-TF

SSC = Para corresponder ao SSC na pastilha.

Componentes	
Plugue	Plugue
3214 013-01	3214 012-01

Para a lista completa de componentes, acesse www.sandvik.coromant.com



Ferramenta convencional CoroCut® QF para usinagem de canais frontais

Fixação por mecanismo tipo mola

Refrigeração de precisão



Curvatura B

SSC	CZC _{MS}	CDX	DAXIN	DAXX	OHX	CNSC	Código para pedido	Dimensões, mm								BAR	KG	MIID
								B	H	HBL	LF	WF	HF	CNT				
QFU-K	32 x 32	32.0	80.0	180.0	51.6	3	QFU-LFK32C3232-080B	32.0	32.0	51.6	170.0	33.0	32.0	G 1/8-28	150	1.18	QFU-K-0600-04-TF	
	32 x 32	32.0	160.0	400.0	51.6	3	QFU-LFK32C3232-160B	32.0	32.0	51.6	170.0	33.0	32.0	G 1/8-28	150	1.18	QFU-K-0600-04-TF	
	32 x 32	32.0	220.0	1000.0	51.6	3	QFU-LFK32C3232-220B	32.0	32.0	51.6	170.0	33.0	32.0	G 1/8-28	150	1.18	QFU-K-0600-04-TF	
QFU-L	32 x 32	33.0	60.0	150.0	52.6	3	QFU-LFL33C3232-060B	32.0	32.0	52.6	170.0	33.0	32.0	G 1/8-28	150	1.18	QFU-L-0800-08-TF	
	32 x 32	38.0	120.0	300.0	57.6	3	QFU-LFL38C3232-120B	32.0	32.0	57.6	170.0	33.0	32.0	G 1/8-28	150	1.18	QFU-L-0800-08-TF	
	32 x 32	50.0	220.0	1000.0	69.6	3	QFU-LFL50C3232-220B	32.0	32.0	69.6	170.0	33.0	32.0	G 1/8-28	150	1.09	QFU-L-0800-08-TF	

SSC = Para corresponder ao SSC na pastilha.

Componentes	
Plugue	Plugue
3214 013-01	3214 012-01

Para a lista completa de componentes, acesse www.sandvik.coromant.com



Ferramenta convencional CoroCut® QF QS para usinagem de canais frontais

Fixação por mecanismo tipo mola

Refrigeração de precisão



Curvatura B

SSC	CZC _{MS}	CDX	DAXIN	DAXX	OHX	OHN	CNSC	Código para pedido	Dimensões, mm									
									B	H	HBL	LF	WF	HF	CNT	BAR	KG	MIID
QFT-G	25 x 25	20.0	30.0	42.0	29.6	29.6	3	QFT-RFG20C2525-030B	25.0	25.0	29.6	113.6	25.5	25.0	G 1/8-28	150	0.50	QFT-G-0300-03-TF
	25 x 25	25.0	35.0	52.0	34.6	34.6	3	QFT-RFG25C2525-035B	25.0	25.0	34.6	118.6	25.5	25.0	G 1/8-28	150	0.48	QFT-G-0300-03-TF
	25 x 25	25.0	45.0	60.0	34.6	34.6	3	QFT-RFG25C2525-045B	25.0	25.0	34.6	118.6	25.5	25.0	G 1/8-28	150	0.48	QFT-G-0300-03-TF
	25 x 25	25.0	55.0	70.0	34.6	34.6	3	QFT-RFG25C2525-055B	25.0	25.0	34.6	118.6	25.5	25.0	G 1/8-28	150	0.48	QFT-G-0300-03-TF
	25 x 25	30.0	70.0	100.0	39.6	39.6	3	QFT-RFG30C2525-070B	25.0	25.0	39.6	123.6	25.5	25.0	G 1/8-28	150	0.48	QFT-G-0300-03-TF
	25 x 25	30.0	100.0	150.0	39.6	39.6	3	QFT-RFG30C2525-100B	25.0	25.0	39.6	123.6	25.5	25.0	G 1/8-28	150	0.48	QFT-G-0300-03-TF
QFT-H	25 x 25	22.0	30.0	45.0	31.6	31.6	3	QFT-RFH22C2525-030B	25.0	25.0	31.6	115.6	25.5	25.0	G 1/8-28	150	0.48	QFT-H-0400-03-TF
	25 x 25	22.0	35.0	55.0	31.6	31.6	3	QFT-RFH22C2525-035B	25.0	25.0	31.6	115.6	25.5	25.0	G 1/8-28	150	0.48	QFT-H-0400-03-TF
	25 x 25	25.0	35.0	55.0	34.6	34.6	3	QFT-RFH25C2525-035B	25.0	25.0	34.6	118.6	25.5	25.0	G 1/8-28	150	0.49	QFT-H-0400-03-TF
	25 x 25	26.0	45.0	75.0	35.6	35.6	3	QFT-RFH26C2525-045B	25.0	25.0	35.6	119.6	25.5	25.0	G 1/8-28	150	0.49	QFT-H-0400-03-TF
	25 x 25	26.0	65.0	108.0	35.6	35.6	3	QFT-RFH26C2525-065B	25.0	25.0	35.6	119.6	25.5	25.0	G 1/8-28	150	0.48	QFT-H-0400-03-TF
	25 x 25	26.0	100.0	160.0	35.6	35.6	3	QFT-RFH26C2525-100B	25.0	25.0	35.6	119.6	25.5	25.0	G 1/8-28	150	0.48	QFT-H-0400-03-TF
	25 x 25	26.0	150.0	310.0	35.6	35.6	3	QFT-RFH26C2525-150B	25.0	25.0	35.6	119.6	25.5	25.0	G 1/8-28	150	0.48	QFT-H-0400-03-TF
	25 x 25	26.0	300.0	510.0	35.6	35.6	3	QFT-RFH26C2525-300B	25.0	25.0	35.6	119.6	25.5	25.0	G 1/8-28	150	0.49	QFT-H-0400-03-TF
	25 x 25	26.0	500.0	2000.0	35.6	35.6	3	QFT-RFH26C2525-500B	25.0	25.0	35.6	119.6	25.5	25.0	G 1/8-28	150	0.48	QFT-H-0400-03-TF
	25 x 25	32.0	45.0	75.0	41.6	41.6	3	QFT-RFH32C2525-045B	25.0	25.0	41.6	125.6	25.5	25.0	G 1/8-28	150	0.49	QFT-H-0400-03-TF
	25 x 25	32.0	65.0	108.0	41.6	41.6	3	QFT-RFH32C2525-065B	25.0	25.0	41.6	125.6	25.5	25.0	G 1/8-28	150	0.50	QFT-H-0400-03-TF
	25 x 25	38.0	100.0	160.0	47.6	47.6	3	QFT-RFH38C2525-100B	25.0	25.0	47.6	131.6	25.5	25.0	G 1/8-28	150	0.50	QFT-H-0400-03-TF
	25 x 25	38.0	150.0	310.0	47.6	47.6	3	QFT-RFH38C2525-150B	25.0	25.0	47.6	131.6	25.5	25.0	G 1/8-28	150	0.50	QFT-H-0400-03-TF
	25 x 25	38.0	300.0	510.0	47.6	47.6	3	QFT-RFH38C2525-300B	25.0	25.0	47.6	131.6	25.5	25.0	G 1/8-28	150	0.50	QFT-H-0400-03-TF
25 x 25	38.0	500.0	2000.0	47.6	47.6	3	QFT-RFH38C2525-500B	25.0	25.0	47.6	131.6	25.5	25.0	G 1/8-28	150	0.50	QFT-H-0400-03-TF	
QFT-K	25 x 25	26.0	45.0	110.0	35.6		3	QFT-RFK26C2525-045B	25.0	25.0	8.0	119.6	26.0	25.0	G 1/8-28	150	0.48	QFT-K-0600-04-TF
	25 x 25	26.0	80.0	180.0	35.6		3	QFT-RFK26C2525-080B	25.0	25.0	8.0	119.6	26.0	25.0	G 1/8-28	150	0.48	QFT-K-0600-04-TF
	25 x 25	32.0	160.0	400.0	41.6		3	QFT-RFK32C2525-160B	25.0	25.0	8.0	125.6	26.0	25.0	G 1/8-28	150	0.48	QFT-K-0600-04-TF

SSC = Para corresponder ao SSC na pastilha.

Componentes	
Plugue	Plugue
3214 013-01	3214 012-01

Para a lista completa de componentes, acesse www.sandvik.coromant.com



Ferramenta convencional CoroCut® QF QS para usinagem de canais frontais

Fixação por mecanismo tipo mola

Refrigeração de precisão



Curvatura B

SSC	CZC _{MS}	CDX	DAXIN	DAXX	OHX	OHN	CNSC	Código para pedido	Dimensões, mm								BAR	KG	MID
									B	H	HBL	LF	WF	HF	CNT				
QFU-G	25 x 25	20.0	30.0	42.0	29.6	29.6	3	QFU-LFG20C2525-030B	25.0	25.0	29.6	113.6	25.5	25.0	G 1/8-28	150	0.48	QFU-G-0300-03-TF	
	25 x 25	25.0	35.0	52.0	34.6	34.6	3	QFU-LFG25C2525-035B	25.0	25.0	34.6	118.6	25.5	25.0	G 1/8-28	150	0.50	QFU-G-0300-03-TF	
	25 x 25	25.0	45.0	60.0	34.6	34.6	3	QFU-LFG25C2525-045B	25.0	25.0	34.6	118.6	25.5	25.0	G 1/8-28	150	0.48	QFU-G-0300-03-TF	
	25 x 25	25.0	55.0	70.0	34.6	34.6	3	QFU-LFG25C2525-055B	25.0	25.0	34.6	118.6	25.5	25.0	G 1/8-28	150	0.48	QFU-G-0300-03-TF	
	25 x 25	30.0	70.0	100.0	39.6	39.6	3	QFU-LFG30C2525-070B	25.0	25.0	39.6	123.6	25.5	25.0	G 1/8-28	150	0.49	QFU-G-0300-03-TF	
	25 x 25	30.0	100.0	156.0	39.6	39.6	3	QFU-LFG30C2525-100B	25.0	25.0	39.6	123.6	25.5	25.0	G 1/8-28	150	0.49	QFU-G-0300-03-TF	
QFU-H	25 x 25	30.0	150.0	310.0	39.6	39.6	3	QFU-LFG30C2525-150B	25.0	25.0	39.6	123.6	25.5	25.0	G 1/8-28	150	0.48	QFU-G-0300-03-TF	
	25 x 25	22.0	30.0	45.0	31.6	31.6	3	QFU-LFH22C2525-030B	25.0	25.0	31.6	115.6	25.5	25.0	G 1/8-28	150	0.49	QFU-H-0400-03-TF	
	25 x 25	22.0	35.0	55.0	31.6	31.6	3	QFU-LFH22C2525-035B	25.0	25.0	31.6	115.6	25.5	25.0	G 1/8-28	150	0.56	QFU-H-0400-03-TF	
	25 x 25	25.0	35.0	55.0	34.6	34.6	3	QFU-LFH25C2525-035B	25.0	25.0	34.6	118.6	25.5	25.0	G 1/8-28	150	0.49	QFU-H-0400-03-TF	
	25 x 25	26.0	45.0	75.0	35.6	35.6	3	QFU-LFH26C2525-045B	25.0	25.0	35.6	119.6	25.5	25.0	G 1/8-28	150	0.48	QFU-H-0400-03-TF	
	25 x 25	26.0	65.0	108.0	35.6	35.6	3	QFU-LFH26C2525-065B	25.0	25.0	35.6	119.6	25.5	25.0	G 1/8-28	150	0.48	QFU-H-0400-03-TF	
	25 x 25	26.0	100.0	160.0	35.6	35.6	3	QFU-LFH26C2525-100B	25.0	25.0	35.6	119.6	25.5	25.0	G 1/8-28	150	0.48	QFU-H-0400-03-TF	
	25 x 25	26.0	150.0	310.0	35.6	35.6	3	QFU-LFH26C2525-150B	25.0	25.0	35.6	119.6	25.5	25.0	G 1/8-28	150	0.49	QFU-H-0400-03-TF	
	25 x 25	26.0	300.0	510.0	35.6	35.6	3	QFU-LFH26C2525-300B	25.0	25.0	35.6	119.6	25.5	25.0	G 1/8-28	150	0.48	QFU-H-0400-03-TF	
	25 x 25	26.0	500.0	2000.0	35.6	35.6	3	QFU-LFH26C2525-500B	25.0	25.0	35.6	119.6	25.5	25.0	G 1/8-28	150	0.48	QFU-H-0400-03-TF	
	25 x 25	32.0	45.0	75.0	41.6	41.6	3	QFU-LFH32C2525-045B	25.0	25.0	41.6	125.6	25.5	25.0	G 1/8-28	150	0.49	QFU-H-0400-03-TF	
	25 x 25	32.0	65.0	108.0	41.6	41.6	3	QFU-LFH32C2525-065B	25.0	25.0	41.6	125.6	25.5	25.0	G 1/8-28	150	0.52	QFU-H-0400-03-TF	
QFU-K	25 x 25	38.0	100.0	160.0	47.6	47.6	3	QFU-LFH38C2525-100B	25.0	25.0	47.6	131.6	25.5	25.0	G 1/8-28	150	0.56	QFU-H-0400-03-TF	
	25 x 25	38.0	150.0	310.0	47.6	47.6	3	QFU-LFH38C2525-150B	25.0	25.0	47.6	131.6	25.5	25.0	G 1/8-28	150	0.50	QFU-H-0400-03-TF	
	25 x 25	38.0	300.0	510.0	47.6	47.6	3	QFU-LFH38C2525-300B	25.0	25.0	47.6	131.6	25.5	25.0	G 1/8-28	150	0.56	QFU-H-0400-03-TF	
	25 x 25	38.0	500.0	2000.0	47.6	47.6	3	QFU-LFH38C2525-500B	25.0	25.0	47.6	131.6	25.5	25.0	G 1/8-28	150	0.56	QFU-H-0400-03-TF	
	25 x 25	26.0	45.0	110.0	35.6		3	QFU-LFK26C2525-045B	25.0	25.0	8.0	119.6	26.0	25.0	G 1/8-28	150	0.48	QFU-K-0600-04-TF	
	25 x 25	26.0	80.0	180.0	35.6		3	QFU-LFK26C2525-080B	25.0	25.0	8.0	119.6	26.0	25.0	G 1/8-28	150	0.48	QFU-K-0600-04-TF	
25 x 25	32.0	160.0	400.0	41.6		3	QFU-LFK32C2525-160B	25.0	25.0	8.0	125.6	26.0	25.0	G 1/8-28	150	0.48	QFU-K-0600-04-TF		

SSC = Para corresponder ao SSC na pastilha.

Componentes	
Plugue	Plugue
3214 013-01	3214 012-01

Para a lista completa de componentes, acesse www.sandvik.coromant.com



Ferramenta convencional CoroCut® QF QS para usinagem de canais frontais

Fixação por mecanismo tipo mola

Refrigeração de precisão

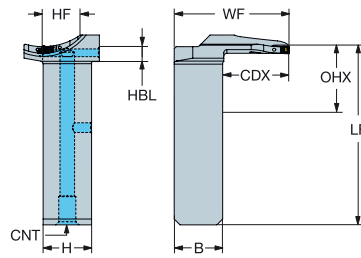
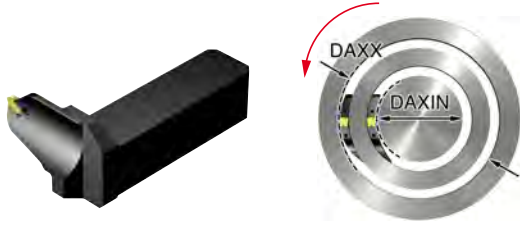

Curvatura B

									Código para pedido	Dimensões, mm							MIID		
	SSC	CZC _{MS}	CDX	DAXIN	DAXX	OHX	OHN	CNSC		B	H	HBL	LF	WF	HF	CNT		BAR	KG
	QFT-H	25 x 25	22.0	30.0	45.0	8.0	8.0	3	QFT-LGH22C2525-030B	25.0	25.0	8.0	92.0	49.1	25.0	G 1/8-28	150	0.50	QFT-H-0400-03-TF
		25 x 25	25.0	35.0	55.0	8.0	8.0	3	QFT-LGH25C2525-035B	25.0	25.0	8.0	92.0	52.1	25.0	G 1/8-28	150	0.50	QFT-H-0400-03-TF
		25 x 25	32.0	45.0	75.0	8.0	8.0	3	QFT-LGH32C2525-045B	25.0	25.0	8.0	92.0	59.1	25.0	G 1/8-28	150	0.51	QFT-H-0400-03-TF
		25 x 25	32.0	65.0	108.0	8.0	8.0	3	QFT-LGH32C2525-065B	25.0	25.0	8.0	92.0	59.1	25.0	G 1/8-28	150	0.51	QFT-H-0400-03-TF
		25 x 25	38.0	100.0	160.0	8.0	8.0	3	QFT-LGH38C2525-100B	25.0	25.0	8.0	92.0	65.1	25.0	G 1/8-28	150	0.53	QFT-H-0400-03-TF
	QFT-K	25 x 25	38.0	150.0	310.0	8.0	8.0	3	QFT-LGH38C2525-150B	25.0	25.0	8.0	92.0	65.1	25.0	G 1/8-28	150	0.50	QFT-H-0400-03-TF
		25 x 25	26.0	45.0	100.0	8.0		3	QFT-LGK26C2525-045B	25.0	25.0	8.0	94.0	52.6	25.0	G 1/8-28	150	0.48	QFT-K-0600-04-TF
		25 x 25	26.0	80.0	180.0	8.0		3	QFT-LGK26C2525-080B	25.0	25.0	8.0	94.0	52.6	25.0	G 1/8-28	150	0.48	QFT-K-0600-04-TF
		25 x 25	32.0	160.0	400.0	8.0		3	QFT-LGK32C2525-160B	25.0	25.0	8.0	94.0	58.6	25.0	G 1/8-28	150	0.48	QFT-K-0600-04-TF

SSC = Para corresponder ao SSC na pastilha.

Componentes	
Plugue	Plugue
3214 013-01	3214 012-01

Para a lista completa de componentes, acesse www.sandvik.coromant.com



Ferramenta convencional CoroCut® QF QS para usinagem de canais frontais

Fixação por mecanismo tipo mola

Refrigeração de precisão

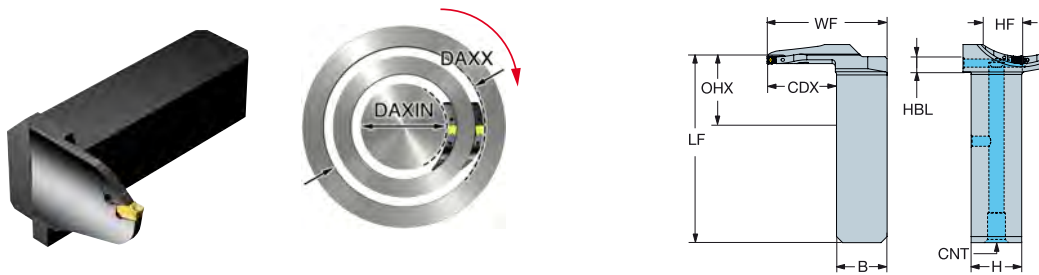

Curvatura B

SSC	CZC _{MS}	CDX	DAXIN	DAXX	OHX	OHN	CNSC	Código para pedido	Dimensões, mm							BAR	KG	MIID
									B	H	HBL	LF	WF	HF	CNT			
QFU-H	25 x 25	22.0	30.0	45.0	8.0	8.0	3	QFU-RGH22C2525-030B	25.0	25.0	8.0	92.0	25.5	25.0	G 1/8-28	150	0.50	QFU-H-0400-03-TF
	25 x 25	25.0	35.0	55.0	8.0	8.0	3	QFU-RGH25C2525-035B	25.0	25.0	8.0	92.0	52.1	25.0	G 1/8-28	150	0.51	QFU-H-0400-03-TF
	25 x 25	32.0	45.0	75.0	8.0	8.0	3	QFU-RGH32C2525-045B	25.0	25.0	8.0	92.0	59.1	25.0	G 1/8-28	150	0.51	QFU-H-0400-03-TF
	25 x 25	32.0	65.0	108.0	8.0	8.0	3	QFU-RGH32C2525-065B	25.0	25.0	8.0	92.0	59.1	25.0	G 1/8-28	150	0.50	QFU-H-0400-03-TF
	25 x 25	38.0	100.0	160.0	8.0	8.0	3	QFU-RGH38C2525-100B	25.0	25.0	8.0	92.0	65.1	25.0	G 1/8-28	150	0.52	QFU-H-0400-03-TF
QFU-K	25 x 25	38.0	150.0	310.0	8.0	8.0	3	QFU-RGH38C2525-150B	25.0	25.0	8.0	92.0	65.1	25.0	G 1/8-28	150	0.52	QFU-H-0400-03-TF
	25 x 25	26.0	45.0	100.0	8.0		3	QFU-RGK26C2525-045B	25.0	25.0	8.0	94.0	52.6	25.0	G 1/8-28	150	0.48	QFU-K-0600-04-TF
	25 x 25	26.0	80.0	180.0	8.0		3	QFU-RGK26C2525-080B	25.0	25.0	8.0	94.0	52.6	25.0	G 1/8-28	150	0.48	QFU-K-0600-04-TF
	25 x 25	32.0	160.0	400.0	8.0		3	QFU-RGK32C2525-160B	25.0	25.0	8.0	94.0	58.6	25.0	G 1/8-28	150	0.48	QFU-K-0600-04-TF

SSC = Para corresponder ao SSC na pastilha.

Componentes	
Plugue	Plugue
3214 013-01	3214 012-01

Para a lista completa de componentes, acesse www.sandvik.coromant.com



Cabeça CoroCut® QF para usinagem de canais frontais

Fixação por mecanismo tipo mola

Refrigeração de precisão

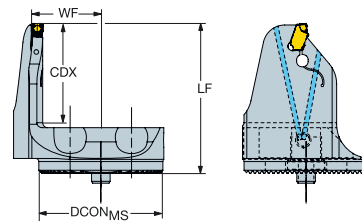
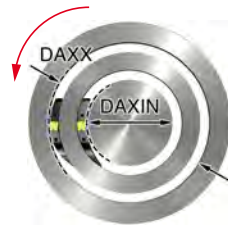

Curvatura B

								Dimensões, mm						MIID	
	SSC	CZC _{MS}	CDX	DAXIN	DAXX	OHN	CNSC	Código para pedido	DCON _{MS}	LF	WF	HF	BAR		KG
	QFT-K	40	26.0	45.0	100.0		1	SL-QFT-RK26C40-045B	40	42.0	24.5	0.1	150	0.13	QFT-K-0600-04-TF
		40	32.0	80.0	180.0		1	SL-QFT-RK32C40-080B	40	48.0	24.5	0.1	150	0.13	QFT-K-0600-04-TF
		40	32.0	160.0	400.0		1	SL-QFT-RK32C40-160B	40	48.0	24.5	0.1	150	0.13	QFT-K-0600-04-TF
		40	32.0	200.0	1000.0		1	SL-QFT-RK32C40-200B	40	48.0	24.5	0.1	150	0.13	QFT-K-0600-04-TF
	QFT-G	40	20.0	30.0	42.0	36.0	1	SL-QFT-RG20C40-030B	40	36.0	22.0	0.1	150	0.42	QFT-G-0300-03-TF
		40	25.0	35.0	52.0	41.0	1	SL-QFT-RG25C40-035B	40	41.0	22.0	0.1	150	0.15	QFT-G-0300-03-TF
		40	25.0	45.0	60.0	41.0	1	SL-QFT-RG25C40-045B	40	41.0	22.0	0.1	150	0.15	QFT-G-0300-03-TF
		40	25.0	55.0	76.0	41.0	1	SL-QFT-RG25C40-055B	40	41.0	22.0	0.1	150	0.15	QFT-G-0300-03-TF
		40	30.0	70.0	106.0	46.0	1	SL-QFT-RG30C40-070B	40	46.0	22.0	0.1	150	0.15	QFT-G-0300-03-TF
		40	30.0	100.0	156.0	46.0	1	SL-QFT-RG30C40-100B	40	46.0	22.0	0.1	150	0.15	QFT-G-0300-03-TF
	QFT-H	40	30.0	150.0	310.0	46.0	1	SL-QFT-RG30C40-150B	40	46.0	22.0	0.1	150	0.15	QFT-G-0300-03-TF
		40	22.0	30.0	45.0	38.0	1	SL-QFT-RH22C40-030B	40	38.0	22.5	0.1	150	0.22	QFT-H-0400-03-TF
40		25.0	35.0	55.0	41.0	1	SL-QFT-RH25C40-035B	40	41.0	22.5	0.1	150	0.22	QFT-H-0400-03-TF	
40		32.0	45.0	75.0	48.0	1	SL-QFT-RH32C40-045B	40	48.0	22.5	0.1	150	0.16	QFT-H-0400-03-TF	
40		32.0	65.0	108.0	48.0	1	SL-QFT-RH32C40-065B	40	48.0	22.5	0.1	150	0.22	QFT-H-0400-03-TF	
40		38.0	100.0	160.0	54.0	1	SL-QFT-RH38C40-100B	40	54.0	22.5	0.1	150	0.18	QFT-H-0400-03-TF	
40		38.0	150.0	310.0	54.0	1	SL-QFT-RH38C40-150B	40	54.0	22.5	0.1	150	0.17	QFT-H-0400-03-TF	
40		38.0	300.0	510.0	54.0	1	SL-QFT-RH38C40-300B	40	54.0	22.5	0.1	150	0.17	QFT-H-0400-03-TF	

SSC = Para corresponder ao SSC na pastilha.

Componentes
Tubo de localização
5638 031-01

Para a lista completa de componentes, acesse www.sandvik.coromant.com



A

Cabeça CoroCut® QF para usinagem de canais frontais

Fixação por mecanismo tipo mola

Refrigeração de precisão

B

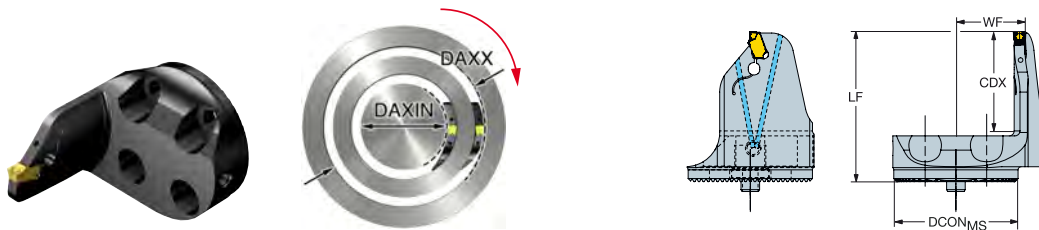

C

Curvatura B

								Código para pedido	Dimensões, mm					MIID		
	SSC	CZC _{MS}	CDX	DAXIN	DAXX	OHN	CNSC		DCON _{MS}	LF	WF	HF	BAR		KG	
	QFU-K	40	26.0	45.0	100.0		1	SL-QFU-LK26C40-045B	40	42.0	24.5	0.1	150	0.13	QFU-K-0600-04-TF	
		40	32.0	80.0	180.0		1	SL-QFU-LK32C40-080B	40	48.0	24.5	0.1	150	0.13	QFU-K-0600-04-TF	
		40	32.0	160.0	400.0		1	SL-QFU-LK32C40-160B	40	48.0	24.5	0.1	150	0.13	QFU-K-0600-04-TF	
		40	32.0	200.0	1000.0		1	SL-QFU-LK32C40-200B	40	48.0	24.5	0.1	150	0.13	QFU-K-0600-04-TF	
	QFU-G	40	20.0	30.0	42.0	36.0		1	SL-QFU-LG20C40-030B	40	36.0	22.0	0.1	150	0.15	QFU-G-0300-03-TF
		40	25.0	35.0	52.0	41.0		1	SL-QFU-LG25C40-035B	40	41.0	22.0	0.1	150	0.15	QFU-G-0300-03-TF
		40	25.0	45.0	60.0	41.0		1	SL-QFU-LG25C40-045B	40	41.0	22.0	0.1	150	0.15	QFU-G-0300-03-TF
		40	25.0	55.0	76.0	41.0		1	SL-QFU-LG25C40-055B	40	41.0	22.0	0.1	150	0.15	QFU-G-0300-03-TF
		40	30.0	70.0	106.0	46.0		1	SL-QFU-LG30C40-070B	40	46.0	22.0	0.1	150	0.15	QFU-G-0300-03-TF
		40	30.0	100.0	156.0	46.0		1	SL-QFU-LG30C40-100B	40	46.0	22.0	0.1	150	0.15	QFU-G-0300-03-TF
QFU-H	40	30.0	150.0	310.0	46.0		1	SL-QFU-LG30C40-150B	40	46.0	22.0	0.1	150	0.15	QFU-G-0300-03-TF	
	40	22.0	30.0	45.0	38.0		1	SL-QFU-LH22C40-030B	40	38.0	22.5	0.1	150	0.22	QFU-H-0400-03-TF	
	40	25.0	35.0	55.0	41.0		1	SL-QFU-LH25C40-035B	40	41.0	22.5	0.1	150	0.22	QFU-H-0400-03-TF	
	40	32.0	45.0	75.0	48.0		1	SL-QFU-LH32C40-045B	40	48.0	22.5	0.1	150	0.22	QFU-H-0400-03-TF	
	40	32.0	65.0	108.0	48.0		1	SL-QFU-LH32C40-065B	40	48.0	22.5	0.1	150	0.22	QFU-H-0400-03-TF	
	40	38.0	100.0	160.0	54.0		1	SL-QFU-LH38C40-100B	40	54.0	22.5	0.1	150	0.17	QFU-H-0400-03-TF	
	40	38.0	150.0	310.0	54.0		1	SL-QFU-LH38C40-150B	40	54.0	22.5	0.1	150	0.17	QFU-H-0400-03-TF	
	40	38.0	300.0	510.0	54.0		1	SL-QFU-LH38C40-300B	40	54.0	22.5	0.1	150	0.22	QFU-H-0400-03-TF	

D

E

SSC = Para corresponder ao SSC na pastilha.

Componentes
Tubo de localização
5638 031-01

Para a lista completa de componentes, acesse www.sandvik.coromant.com

F

G

H



Cabeça CoroCut® QF para usinagem de canais frontais

Fixação por mecanismo tipo mola

Refrigeração de precisão



Curvatura A

								Dimensões, mm							MIID	
	SSC	CZC _{MS}	CDX	DAXIN	DAXX	OHN	CNSC	Código para pedido	DCON _{MS}	LF	WF	HF	BAR	KG		
	QFT-G	32	20.0	30.0	42.0	36.0	1	SL-QFT-LG20C32-030A	32	36.0	18.0	0.1	150	0.11	QFT-G-0300-03-TF	
		32	25.0	35.0	52.0	41.0	1	SL-QFT-LG25C32-035A	32	41.0	18.0	0.1	150	0.10	QFT-G-0300-03-TF	
		32	25.0	45.0	60.0	41.0	1	SL-QFT-LG25C32-045A	32	41.0	18.0	0.1	150	0.11	QFT-G-0300-03-TF	
		40	25.0	38.0	52.0	41.0	1	SL-QFT-LG25C40-038A	40	41.0	22.0	0.1	150	0.14	QFT-G-0300-03-TF	
		40	25.0	45.0	60.0	41.0	1	SL-QFT-LG25C40-045A	40	41.0	22.0	0.1	150	0.17	QFT-G-0300-03-TF	
		40	25.0	55.0	76.0	41.0	1	SL-QFT-LG25C40-055A	40	41.0	22.0	0.1	150	0.14	QFT-G-0300-03-TF	
		40	30.0	70.0	106.0	46.0	1	SL-QFT-LG30C40-070A	40	46.0	22.0	0.1	150	0.15	QFT-G-0300-03-TF	
		40	30.0	100.0	156.0	46.0	1	SL-QFT-LG30C40-100A	40	46.0	22.0	0.1	150	0.15	QFT-G-0300-03-TF	
		40	30.0	150.0	310.0	46.0	1	SL-QFT-LG30C40-150A	40	46.0	22.0	0.1	150	0.15	QFT-G-0300-03-TF	
		QFT-H	32	22.0	30.0	45.0	38.0	1	SL-QFT-LH22C32-030A	32	38.0	18.5	0.1	150	0.11	QFT-H-0400-03-TF
			32	25.0	35.0	55.0	41.0	1	SL-QFT-LH25C32-035A	32	41.0	18.5	0.1	150	0.11	QFT-H-0400-03-TF
			40	25.0	36.0	55.0	41.0	1	SL-QFT-LH25C40-036A	40	41.0	22.5	0.1	150	0.15	QFT-H-0400-03-TF
		40	32.0	45.0	75.0	48.0	1	SL-QFT-LH32C40-045A	40	48.0	22.5	0.1	150	0.15	QFT-H-0400-03-TF	
		40	32.0	65.0	108.0	48.0	1	SL-QFT-LH32C40-065A	40	48.0	22.5	0.1	150	0.16	QFT-H-0400-03-TF	
		40	38.0	100.0	160.0	54.0	1	SL-QFT-LH38C40-100A	40	54.0	22.5	0.1	150	0.22	QFT-H-0400-03-TF	
		40	38.0	150.0	310.0	54.0	1	SL-QFT-LH38C40-150A	40	54.0	22.5	0.1	150	0.22	QFT-H-0400-03-TF	
		40	38.0	300.0	510.0	54.0	1	SL-QFT-LH38C40-300A	40	54.0	22.5	0.1	150	0.22	QFT-H-0400-03-TF	
	QFT-K	40	26.0	45.0	100.0		1	SL-QFT-LK26C40-045A	40	42.0	24.5	0.1	150	0.13	QFT-K-0600-04-TF	
		40	32.0	80.0	180.0		1	SL-QFT-LK32C40-080A	40	48.0	24.5	0.1	150	0.13	QFT-K-0600-04-TF	
		40	32.0	160.0	400.0		1	SL-QFT-LK32C40-160A	40	48.0	24.5	0.1	150	0.13	QFT-K-0600-04-TF	
		40	32.0	200.0	1000.0		1	SL-QFT-LK32C40-200A	40	48.0	24.5	0.1	150	0.13	QFT-K-0600-04-TF	

SSC = Para corresponder ao SSC na pastilha.

Componentes
Tubo de localização
5638 031-01

Para a lista completa de componentes, acesse www.sandvik.coromant.com



B70



H36



H5

Cabeça CoroCut® QF para usinagem de canais frontais

Fixação por mecanismo tipo mola

Refrigeração de precisão

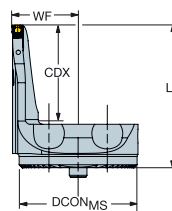
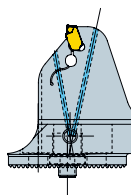

Curvatura A

SSC	CZC _{MS}	CDX	DAXIN	DAXX	OHN	CNSC	Código para pedido	Dimensões, mm						MIID
								DCON _{MS}	LF	WF	HF	BAR	KG	
QFU-G	32	20.0	30.0	42.0	36.0	1	SL-QFU-RG20C32-030A	32	36.0	18.0	0.1	150	0.10	QFU-G-0300-03-TF
	32	25.0	35.0	52.0	41.0	1	SL-QFU-RG25C32-035A	32	41.0	18.0	0.1	150	0.21	QFU-G-0300-03-TF
	32	25.0	45.0	60.0	41.0	1	SL-QFU-RG25C32-045A	32	41.0	18.0	0.1	150	0.11	QFU-G-0300-03-TF
	40	25.0	38.0	52.0	41.0	1	SL-QFU-RG25C40-038A	40	41.0	22.0	0.1	150	0.22	QFU-G-0300-03-TF
	40	25.0	45.0	60.0	41.0	1	SL-QFU-RG25C40-045A	40	41.0	22.0	0.1	150	0.14	QFU-G-0300-03-TF
	40	25.0	55.0	76.0	41.0	1	SL-QFU-RG25C40-055A	40	41.0	22.0	0.1	150	0.14	QFU-G-0300-03-TF
	40	30.0	70.0	106.0	46.0	1	SL-QFU-RG30C40-070A	40	46.0	22.0	0.1	150	0.14	QFU-G-0300-03-TF
	40	30.0	100.0	156.0	46.0	1	SL-QFU-RG30C40-100A	40	46.0	22.0	0.1	150	0.15	QFU-G-0300-03-TF
	40	30.0	150.0	310.0	46.0	1	SL-QFU-RG30C40-150A	40	46.0	22.0	0.1	150	0.15	QFU-G-0300-03-TF
	QFU-H	32	22.0	30.0	45.0	38.0	1	SL-QFU-RH25C32-030A	32	38.0	18.5	0.1	150	0.12
32		25.0	35.0	52.0	41.0	1	SL-QFU-RH25C32-035A	32	41.0	18.5	0.1	150	0.11	QFU-H-0400-03-TF
40		25.0	36.0	55.0	41.0	1	SL-QFU-RH25C40-036A	40	41.0	22.5	0.1	150	0.15	QFU-H-0400-03-TF
40		32.0	45.0	75.0	48.0	1	SL-QFU-RH32C40-045A	40	48.0	22.5	0.1	150	0.15	QFU-H-0400-03-TF
40		32.0	65.0	108.0	48.0	1	SL-QFU-RH32C40-065A	40	48.0	22.5	0.1	150	0.16	QFU-H-0400-03-TF
40		38.0	100.0	160.0	54.0	1	SL-QFU-RH38C40-100A	40	54.0	22.5	0.1	150	0.17	QFU-H-0400-03-TF
40		38.0	150.0	310.0	54.0	1	SL-QFU-RH38C40-150A	40	54.0	22.5	0.1	150	0.17	QFU-H-0400-03-TF
40		38.0	300.0	510.0	54.0	1	SL-QFU-RH38C40-300A	40	54.0	22.5	0.1	150	0.17	QFU-H-0400-03-TF
QFU-K	40	26.0	45.0	100.0		1	SL-QFU-RK26C40-045A	40	42.0	24.5	0.1	150	0.13	QFU-K-0600-04-TF
	40	32.0	80.0	180.0		1	SL-QFU-RK32C40-080A	40	48.0	24.5	0.1	150	0.13	QFU-K-0600-04-TF
	40	32.0	160.0	400.0		1	SL-QFU-RK32C40-160A	40	48.0	24.5	0.1	150	0.13	QFU-K-0600-04-TF
	40	32.0	200.0	1000.0		1	SL-QFU-RK32C40-200A	40	48.0	24.5	0.1	150	0.13	QFU-K-0600-04-TF

SSC = Para corresponder ao SSC na pastilha.

Componentes
Tubo de localização
5638 031-01

Para a lista completa de componentes, acesse www.sandvik.coromant.com



CoroCut® 3

Cortes rasos e canais de alta precisão

Aplicação

- Corte
- Usinagem de canais circlip
- Canais externos
- Perfilamento
- Otimizado para corte de anéis do rolamento

Área de aplicação ISO:



Características e benefícios

- Usinagem de canais de precisão em larguras bem estreitas
- Versatilidade máxima – um suporte para todas as larguras de pastilhas
- Custo otimizado devido às três arestas de corte
- Interface estável
- Pastilhas com três arestas e tolerâncias de indexação da pastilha muito estreitas
- Pastilhas Tailor Made disponíveis

www.sandvik.coromant.com/corocut3

Pastilhas

- GC1125: Uma classe versátil para quatro geometrias diferentes:
- CM para cortes em áreas de avanço médio
- CS para cortes em usinagem com avanço extremamente baixo
- GS para usinagem de canais em baixo avanço
- RS para perfilamento e usinagem de canais com baixo avanço

Ferramentas

- Coromant Capto®
- Ferramentas convencionais QS
- Suportes para hastes retangulares
- Cabeças de corte CoroTurn® SL

Pastilhas com ângulo frontal

Pastilhas disponíveis com ângulo frontal para cortes sem saliências (pip) ou rebarbas.

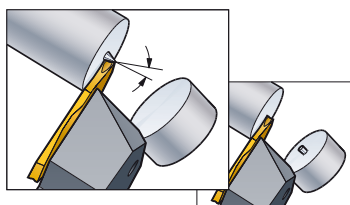

Localização da pastilha independente se ocorrer quebra

As pastilhas podem ser indexadas diretamente na máquina com duas voltas no parafuso. Se ocorrer quebra da pastilha, o mecanismo de fixação não será afetado - é só trocar a pastilha e reiniciar a máquina.

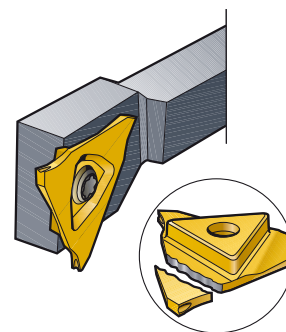

B88



B88





H35

A



POR

B Pastilhas

	Cortes		Canais	Perfilamento
				
	123-CM	123-CS	123-GS	123-RS
Largura da pastilha, mm	1.00-2.00	1.00-2.00	0.50-3.18	0.50-3.00
Página	B89	B89	B91	B92

C

D Ferramentas

		
Sistemas de fixação	Corte e canais	Canais
Coromant Capto®	B93	
Haste	B94	
Cabeça de corte CoroTurn® SL		B95

E

F

G

H

Pastilha CoroCut® 3 para cortes

Cortes rasos

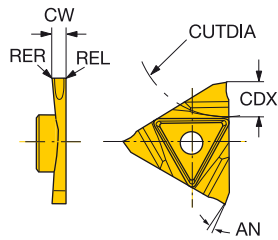

	SSC	CW	REL	RER	CDX	Código para pedido	Dimensões, mm					AN	CUTDIA	CWTOLL	CWTOLU	RETOLL	RETOLU
							P	M	K	N	S						
Acabamento	T	1.00	0.00	0.00	4.3	N123T3-0100-0000-CS	★	★	★	★	★	7°	50.00	-0.050	0.030	0.000	0.050
		1.50	0.00	0.00	6.4	N123T3-0150-0000-CS	★	★	★	★	★	7°	100.00	-0.050	0.030	0.000	0.050
		2.00	0.00	0.00	6.4	N123T3-0200-0000-CS	★	★	★	★	★	7°	100.00	-0.050	0.030	0.000	0.050
	U	1.00	0.00	0.00	4.3	N123U3-0100-0000-CS	★	★	★	★	★	7°	50.00	-0.050	0.030	0.000	0.050
		1.50	0.00	0.00	6.4	N123U3-0150-0000-CS	★	★	★	★	★	7°	100.00	-0.050	0.030	0.000	0.050
		2.00	0.00	0.00	6.4	N123U3-0200-0000-CS	★	★	★	★	★	7°	100.00	-0.050	0.030	0.000	0.050
Média	T	1.00	0.10	0.10	4.3	N123T3-0100-0001-CM	★	★	★	★	★	7°	50.00	-0.030	0.030	-0.050	0.050
		1.50	0.10	0.10	6.4	N123T3-0150-0001-CM	★	★	★	★	★	7°	100.00	-0.030	0.030	-0.050	0.050
		2.00	0.10	0.10	6.4	N123T3-0200-0001-CM	★	★	★	★	★	7°	100.00	-0.030	0.030	-0.050	0.050
	U	1.00	0.10	0.10	4.3	N123U3-0100-0001-CM	★	★	★	★	★	7°	50.00	-0.030	0.030	-0.050	0.050
		1.50	0.10	0.10	6.4	N123U3-0150-0001-CM	★	★	★	★	★	7°	100.00	-0.030	0.030	-0.050	0.050
		2.00	0.10	0.10	6.4	N123U3-0200-0001-CM	★	★	★	★	★	7°	100.00	-0.030	0.030	-0.050	0.050

SSC = Para corresponder ao SSC no suporte.

T = Pastilha versão direita, U = Pastilha versão esquerda.

N = neutra



B88



B130



B149

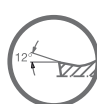

B143



H36



H35



H17

Pastilha CoroCut® 3 para cortes

Cortes rasos

B

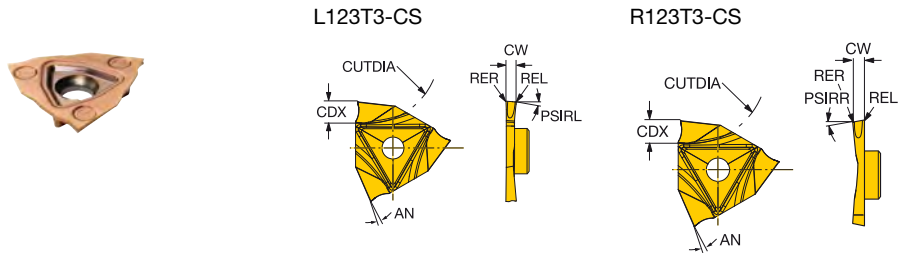

C

								P	M	K	N	S	Dimensões, mm							
		SSC	CW	REL	RER	CDX	PSIRL	PSIRR	Código para pedido	1125	1125	1125	1125	AN	CUTDIA	CWTOLL	CWTOLU	RETOLL	RETOLU	
Acabamento		T	1.00	0.00	0.00	4.2	5.0		L123T3-0100-0500-CS	*	*	*	*	7°	50.00	-0.100	0.000	0.000	0.050	
			1.00	0.00	0.00	4.2	10.0		L123T3-0100-1000-CS	*	*	*	*	7°	50.00	-0.100	0.000	0.000	0.050	
			2.00	0.00	0.00	6.3	10.0		L123T3-0200-1000-CS	*	*	*	*	7°	100.00	-0.100	0.000	0.000	0.050	
			2.00	0.00	0.00	6.3	15.0		L123T3-0200-1500-CS	*	*	*	*	7°	100.00	-0.100	0.000	0.000	0.050	
			1.00	0.00	0.00	4.2		5.0		R123T3-0100-0500-CS	*	*	*	*	7°	50.00	-0.100	0.000	0.000	0.050
			1.00	0.00	0.00	4.2		10.0		R123T3-0100-1000-CS	*	*	*	*	7°	50.00	-0.100	0.000	0.000	0.050
			1.00	0.00	0.00	4.2		15.0		R123T3-0100-1500-CS	*	*	*	*	7°	50.00	-0.100	0.000	0.000	0.050
			1.50	0.00	0.00	6.3		5.0		R123T3-0150-0500-CS	*	*	*	*	7°	100.00	-0.100	0.000	0.000	0.050
			1.50	0.00	0.00	6.3		10.0		R123T3-0150-1000-CS	*	*	*	*	7°	100.00	-0.100	0.000	0.000	0.050
			1.50	0.00	0.00	6.3		15.0		R123T3-0150-1500-CS	*	*	*	*	7°	100.00	-0.100	0.000	0.000	0.050
			2.00	0.00	0.00	6.3		5.0		R123T3-0200-0500-CS	*	*	*	*	7°	100.00	-0.100	0.000	0.000	0.050
			2.00	0.00	0.00	6.3		10.0		R123T3-0200-1000-CS	*	*	*	*	7°	100.00	-0.100	0.000	0.000	0.050
			2.00	0.00	0.00	6.3		15.0		R123T3-0200-1500-CS	*	*	*	*	7°	100.00	-0.100	0.000	0.000	0.050

D

E

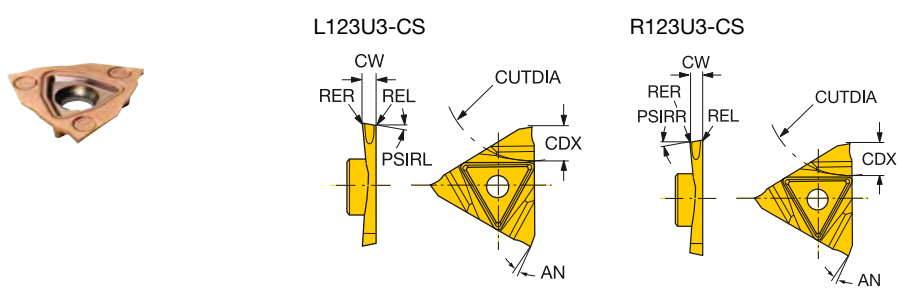

F

								P	M	K	N	S	Dimensões, mm							
		SSC	CW	REL	RER	CDX	PSIRL	PSIRR	Código para pedido	1125	1125	1125	1125	AN	CUTDIA	CWTOLL	CWTOLU	RETOLL	RETOLU	
Acabamento		U	1.00	0.00	0.00	4.2	5.0		L123U3-0100-0500-CS	*	*	*	*	7°	50.00	-0.100	0.000	0.000	0.050	
			1.00	0.00	0.00	4.2	10.0		L123U3-0100-1000-CS	*	*	*	*	7°	50.00	-0.100	0.000	0.000	0.050	
			1.00	0.00	0.00	4.2	15.0		L123U3-0100-1500-CS	*	*	*	*	7°	50.00	-0.100	0.000	0.000	0.050	
			1.50	0.00	0.00	6.3	5.0		L123U3-0150-0500-CS	*	*	*	*	7°	100.00	-0.100	0.000	0.000	0.050	
			1.50	0.00	0.00	6.3	10.0		L123U3-0150-1000-CS	*	*	*	*	7°	100.00	-0.100	0.000	0.000	0.050	
			1.50	0.00	0.00	6.3	15.0		L123U3-0150-1500-CS	*	*	*	*	7°	100.00	-0.100	0.000	0.000	0.050	
			2.00	0.00	0.00	6.3	5.0		L123U3-0200-0500-CS	*	*	*	*	7°	100.00	-0.100	0.000	0.000	0.050	
			2.00	0.00	0.00	6.3	10.0		L123U3-0200-1000-CS	*	*	*	*	7°	100.00	-0.100	0.000	0.000	0.050	
			2.00	0.00	0.00	6.3	15.0		L123U3-0200-1500-CS	*	*	*	*	7°	100.00	-0.100	0.000	0.000	0.050	
			1.00	0.00	0.00	4.2		5.0		R123U3-0100-0500-CS	*	*	*	*	7°	50.00	-0.100	0.000	0.000	0.050
			1.00	0.00	0.00	4.2		10.0		R123U3-0100-1000-CS	*	*	*	*	7°	50.00	-0.100	0.000	0.000	0.050
			1.50	0.00	0.00	6.3		5.0		R123U3-0150-0500-CS	*	*	*	*	7°	100.00	-0.100	0.000	0.000	0.050
			1.50	0.00	0.00	6.3		10.0		R123U3-0150-1000-CS	*	*	*	*	7°	100.00	-0.100	0.000	0.000	0.050
			1.50	0.00	0.00	6.3		15.0		R123U3-0150-1500-CS	*	*	*	*	7°	100.00	-0.100	0.000	0.000	0.050
			2.00	0.00	0.00	6.3		5.0		R123U3-0200-0500-CS	*	*	*	*	7°	100.00	-0.100	0.000	0.000	0.050
	2.00	0.00	0.00	6.3		10.0		R123U3-0200-1000-CS	*	*	*	*	7°	100.00	-0.100	0.000	0.000	0.050		
	2.00	0.00	0.00	6.3		15.0		R123U3-0200-1500-CS	*	*	*	*	7°	100.00	-0.100	0.000	0.000	0.050		

G

SSC = Para corresponder ao SSC no suporte. R = versão direita, L = versão esquerda
 T = Pastilha versão direita, U = Pastilha versão esquerda

H

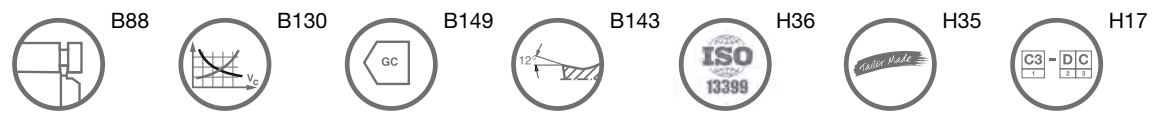

Pastilha CoroCut® 3 para canais

Canais

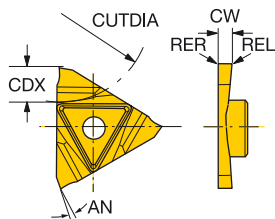

Acabamento	SSC	CW	REL	RER	CDX	Código para pedido	P	M	K	N	S	Dimensões, mm					
							1125	1125	1125	1125	1125	AN	CUTDIA	CWTOLL	CWTOLU	RETOLL	RETOLU
							*	*	*	*	*	7°	100.00	-0.020	0.020	0.000	0.050
	T	0.50	0.00	0.00	1.5	N123T3-0050-0000-GS	*	*	*	*	*	7°	100.00	-0.020	0.020	0.000	0.050
		0.60	0.00	0.00	1.6	N123T3-0060-0000-GS	*	*	*	*	*	7°	100.00	-0.020	0.020	0.000	0.050
		0.70	0.00	0.00	1.7	N123T3-0070-0000-GS	*	*	*	*	*	7°	100.00	-0.020	0.020	0.000	0.050
		0.80	0.00	0.00	1.8	N123T3-0080-0000-GS	*	*	*	*	*	7°	100.00	-0.020	0.020	0.000	0.050
		0.90	0.00	0.00	2.0	N123T3-0090-0000-GS	*	*	*	*	*	7°	100.00	-0.020	0.020	0.000	0.050
		1.00	0.00	0.00	2.2	N123T3-0100-0000-GS	*	*	*	*	*	7°	100.00	-0.020	0.020	0.000	0.050
		1.20	0.00	0.00	2.3	N123T3-0120-0000-GS	*	*	*	*	*	7°	100.00	-0.020	0.020	0.000	0.050
		1.40	0.00	0.00	2.7	N123T3-0140-0000-GS	*	*	*	*	*	7°	100.00	-0.020	0.020	0.000	0.050
		1.50	0.00	0.00	3.0	N123T3-0150-0000-GS	*	*	*	*	*	7°	100.00	-0.020	0.020	0.000	0.050
		1.60	0.00	0.00	3.2	N123T3-0160-0000-GS	*	*	*	*	*	7°	100.00	-0.020	0.020	0.000	0.050
		1.70	0.00	0.00	3.3	N123T3-0170-0000-GS	*	*	*	*	*	7°	100.00	-0.020	0.020	0.000	0.050
		1.95	0.00	0.00	3.9	N123T3-0195-0000-GS	*	*	*	*	*	7°	100.00	-0.020	0.020	0.000	0.050
		2.00	0.00	0.00	4.0	N123T3-0200-0000-GS	*	*	*	*	*	7°	100.00	-0.020	0.020	0.000	0.050
		2.25	0.00	0.00	4.5	N123T3-0225-0000-GS	*	*	*	*	*	7°	100.00	-0.020	0.020	0.000	0.050
		2.50	0.00	0.00	5.0	N123T3-0250-0000-GS	*	*	*	*	*	7°	100.00	-0.020	0.020	0.000	0.050
		2.75	0.00	0.00	5.5	N123T3-0275-0000-GS	*	*	*	*	*	7°	100.00	-0.020	0.020	0.000	0.050
		3.00	0.00	0.00	6.0	N123T3-0300-0000-GS	*	*	*	*	*	7°	100.00	-0.020	0.020	0.000	0.050
		3.18	0.00	0.00	6.0	N123T3-0318-0000-GS	*	*	*	*	*	7°	100.00	-0.020	0.020	0.000	0.050

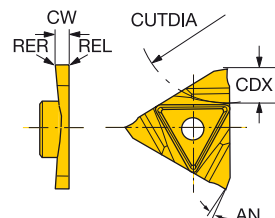

Acabamento	SSC	CW	REL	RER	CDX	Código para pedido	P	M	K	N	S	Dimensões, mm					
							1125	1125	1125	1125	1125	AN	CUTDIA	CWTOLL	CWTOLU	RETOLL	RETOLU
							*	*	*	*	*	7°	100.00	-0.020	0.020	0.000	0.050
	U	0.50	0.00	0.00	1.5	N123U3-0050-0000-GS	*	*	*	*	*	7°	100.00	-0.020	0.020	0.000	0.050
		0.70	0.00	0.00	1.7	N123U3-0070-0000-GS	*	*	*	*	*	7°	100.00	-0.020	0.020	0.000	0.050
		0.80	0.00	0.00	1.8	N123U3-0080-0000-GS	*	*	*	*	*	7°	100.00	-0.020	0.020	0.000	0.050
		0.90	0.00	0.00	2.0	N123U3-0090-0000-GS	*	*	*	*	*	7°	100.00	-0.020	0.020	0.000	0.050
		1.00	0.00	0.00	2.2	N123U3-0100-0000-GS	*	*	*	*	*	7°	100.00	-0.020	0.020	0.000	0.050
		1.20	0.00	0.00	2.3	N123U3-0120-0000-GS	*	*	*	*	*	7°	100.00	-0.020	0.020	0.000	0.050
		1.40	0.00	0.00	2.7	N123U3-0140-0000-GS	*	*	*	*	*	7°	100.00	-0.020	0.020	0.000	0.050
		1.50	0.00	0.00	3.0	N123U3-0150-0000-GS	*	*	*	*	*	7°	100.00	-0.020	0.020	0.000	0.050
		1.60	0.00	0.00	3.2	N123U3-0160-0000-GS	*	*	*	*	*	7°	100.00	-0.020	0.020	0.000	0.050
		1.70	0.00	0.00	3.3	N123U3-0170-0000-GS	*	*	*	*	*	7°	100.00	-0.020	0.020	0.000	0.050
		2.00	0.00	0.00	4.0	N123U3-0200-0000-GS	*	*	*	*	*	7°	100.00	-0.020	0.020	0.000	0.050
		2.25	0.00	0.00	4.5	N123U3-0225-0000-GS	*	*	*	*	*	7°	100.00	-0.020	0.020	0.000	0.050
		2.50	0.00	0.00	5.0	N123U3-0250-0000-GS	*	*	*	*	*	7°	100.00	-0.020	0.020	0.000	0.050
		3.00	0.00	0.00	6.0	N123U3-0300-0000-GS	*	*	*	*	*	7°	100.00	-0.020	0.020	0.000	0.050

SSC = Para corresponder ao SSC no suporte.

N = neutra

T = Pastilha versão direita, U = Pastilha versão esquerda.



B88



B130



B149

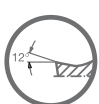

B143



H36



H35



H17

Pastilha CoroCut® 3 para perfilamento

Canais/Perfilamento

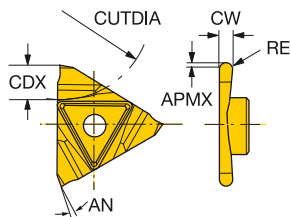

Acabamento	SSC	CW	RE	CDX	Código para pedido	P	M	K	N	S	Dimensões, mm						
						1125	1125	1125	1125	1125	AN	CUTDIA	CWTOLL	CWTOLU	RETOLL	RETOLU	
						*	*	*	*	*	7°	100.00	-0.020	0.020	-0.050	0.050	
T	0.50	0.25	1.5		N123T3-0050-RS	*	*	*	*	*	7°	100.00	-0.020	0.020	-0.050	0.050	
	0.80	0.40	1.8		N123T3-0080-RS	*	*	*	*	*	7°	100.00	-0.020	0.020	-0.050	0.050	
	1.00	0.50	2.2		N123T3-0100-RS	*	*	*	*	*	7°	100.00	-0.020	0.020	-0.050	0.050	
	1.50	0.75	3.3		N123T3-0150-RS	*	*	*	*	*	7°	100.00	-0.020	0.020	-0.050	0.050	
	2.00	1.00	4.0		N123T3-0200-RS	*	*	*	*	*	7°	100.00	-0.020	0.020	-0.050	0.050	
	2.50	1.25	5.0		N123T3-0250-RS	*	*	*	*	*	7°	100.00	-0.020	0.020	-0.050	0.050	
	3.00	1.50	6.0		N123T3-0300-RS	*	*	*	*	*	7°	100.00	-0.020	0.020	-0.050	0.050	
	U	0.50	0.25	1.5		N123U3-0050-RS	*	*	*	*	*	7°	100.00	-0.020	0.020	-0.050	0.050
		0.80	0.40	1.8		N123U3-0080-RS	*	*	*	*	*	7°	100.00	-0.020	0.020	-0.050	0.050
		1.00	0.50	2.2		N123U3-0100-RS	*	*	*	*	*	7°	100.00	-0.020	0.020	-0.050	0.050
1.50		0.75	3.3		N123U3-0150-RS	*	*	*	*	*	7°	100.00	-0.020	0.020	-0.050	0.050	
2.00		1.00	4.0		N123U3-0200-RS	*	*	*	*	*	7°	100.00	-0.020	0.020	-0.050	0.050	
					N123U3-0300-RS	*	*	*	*	*	7°	100.00	-0.020	0.020	-0.050	0.050	

SSC = Para corresponder ao SSC no suporte.

N = neutra

T = Pastilha versão direita, U = Pastilha versão esquerda.

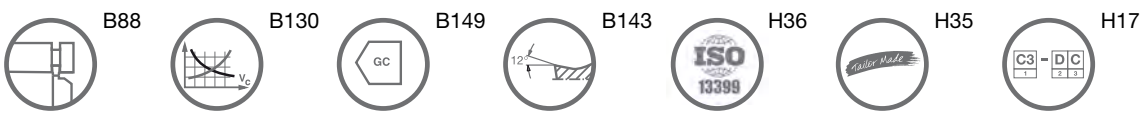

Unidade de corte CoroCut® 3 para cortes e canais

Fixação por parafuso

Coromant Capto® - Refrigeração interna

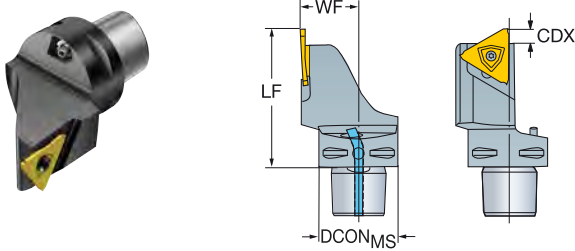

SSC	CZC _{MS}	CDX	GNSC	Código para pedido	Dimensões, mm						MIID
					DCON _{MS}	LF	WF	BAR	NM	KG	
T	C3	6.4	3	C3-RF123T06-22045BM	32	45.0	22.0	10	3.0	0.23	N123T3-0150- CM
	C4	6.4	3	C4-RF123T06-27060BM	40	60.0	27.0	10	3.0	0.45	N123T3-0150- CM
U	C3	6.4	3	C3-LF123U06-22045BM	32	45.0	22.0	10	3.0	0.23	N123U3-0150- CM
	C4	6.4	3	C4-LF123U06-27060BM	40	60.0	27.0	10	3.0	0.45	N123U3-0150- CM

SSC = Para corresponder ao SSC na pastilha.

R = versão direita, L = versão esquerda

T = Pastilha versão direita, U = Pastilha versão esquerda.

Componentes	
Parafuso	Olhal
5513 020-62	5691 034-01

Para a lista completa de componentes, acesse www.sandvik.coromant.com



Ferramenta convencional CoroCut® 3 para cortes e canais

Fixação por parafuso

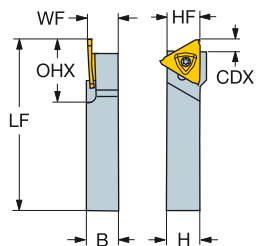

SSC	CZC _{MS}	CDX	OHX	Código para pedido	Dimensões, mm						NM	KG	MIID
					B	H	LF	WF	HF				
T	20 x 20	6.4	23.0	RF123T06-2020BM	20.0	20.0	125.0	20.0	20.0	3.0	0.39	N123T3-0150-CM	
	25 x 25	6.4	23.0	RF123T06-2525BM	25.0	25.0	150.0	25.0	25.0	3.0	0.71	N123T3-0150-CM	
	32 x 32	6.4	23.0	RF123T06-3232BM	32.0	32.0	170.0	32.0	32.0	3.0	1.31	N123T3-0150-CM	
U	20 x 20	6.4	23.0	LF123U06-2020BM	20.0	20.0	125.0	20.0	20.0	3.0	0.39	N123U3-0150-CM	
	25 x 25	6.4	23.0	LF123U06-2525BM	25.0	25.0	150.0	25.0	25.0	3.0	0.71	N123U3-0150-CM	
	32 x 32	6.4	23.0	LF123U06-3232BM	32.0	32.0	170.0	32.0	32.0	3.0	1.31	N123U3-0150-CM	

SSC = Para corresponder ao SSC na pastilha.
 T = Pastilha versão direita, U = Pastilha versão esquerda.

R = versão direita, L = versão esquerda

Componentes
Parafuso
5513 020-62

Para a lista completa de componentes, acesse www.sandvik.coromant.com



Cabeça CoroCut® 3 para canais

Fixação por parafuso

CoroTurn® SL - Refrigeração interna

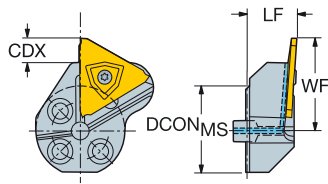

SSC	CZC _{MS}	CDX	CNSC	Código para pedido	Dimensões, mm						MID
					DCON _{MS}	LF	WF	BAR	NM	KG	
T	25	6.4	1	570-25L123T06B	25	14.0	26.0	10	3.0	0.08	N123T3-0150- CM
	32	6.4	1	570-32L123T06B	32	14.0	28.5	10	3.0	0.11	N123T3-0150- CM
	40	6.4	1	570-40L123T06B	40	14.0	32.5	10	3.0	0.15	N123T3-0150- CM
U	25	6.4	1	570-25R123U06B	25	14.0	26.0	10	3.0	0.08	N123U3-0150- CM
	32	6.4	1	570-32R123U06B	32	14.0	28.5	10	3.0	0.11	N123U3-0150- CM
	40	6.4	1	570-40R123U06B	40	14.0	32.5	10	3.0	0.15	N123U3-0150- CM

SSC = Para corresponder ao SSC na pastilha.

R = versão direita, L = versão esquerda

T = Pastilha versão direita, U = Pastilha versão esquerda.

Componentes	
Parafuso de fixação	Tubo para refrigeração
5513 020-62	5691 041-01

Para a lista completa de componentes, acesse www.sandvik.coromant.com



CoroCut® XS

Para usinagem externa de peças pequenas e delgadas

Aplicação

- Corte
- Rosqueamento externo
- Canais externos
- Torneamento

Área de aplicação ISO:



Características e benefícios

- Alta precisão
- Tolerâncias estreitas
- Boa acessibilidade ao trocar as pastilhas
- Ampla variedade de larguras de pastilhas
- Arestas de corte vivas
- Todas as pastilhas se adaptam ao mesmo porta-ferramentas
- Suportes e pastilhas retificadas de alta qualidade
- Pastilhas de perfil completo para roscas de alta qualidade em uma operação
- Desenvolvido para manter o porta-ferramenta intacto caso a pastilha quebre.
- Disponível com refrigeração de alta precisão

www.sandvik.coromant.com/corocutxs

Suportes

Suportes dedicados para cortes próximos ao subspindle estão disponíveis com haste quadrada de alta precisão.

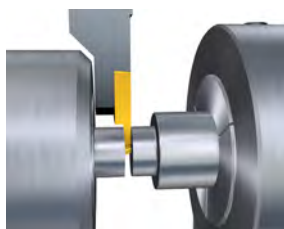

Pastilhas

Torneamento	Torneamento reverso	Corte	Canais	Perfilamento	Rosqueamento
A277	A277	B97	B117	B121	C56

Ferramentas

Ferramenta convencional QST TM	Cabeças de corte CoroTurn® SL
B99	B100

Pastilha CoroCut® XS para cortes



MACR/L-L

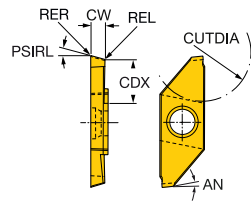

MACR/L-N

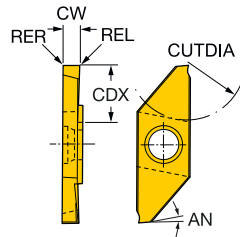

MACR/L-R

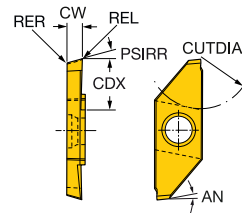

MACR/L-T

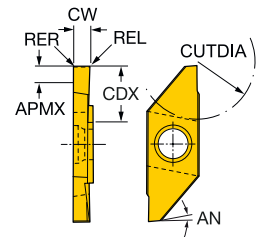

	SSC	CW	REL	RER	CDX	PSIRL	PSIRR	Código para pedido	P					M			K			N			S			Dimensões, mm	
									1025	1105	1025	1105	H13A	1025	1105	H13A	1025	1105	H13A	1025	1105	H13A	AN				
	3	0.70	0.05	0.05	4.3	15°		MACR/L 3 070-R	★	★	★															6°	
		1.00	0.05	0.05	6.3	15°		MACR/L 3 100-R	★	★	★	☆	★	☆	★	★	★	★	★	★	★	★	★	★	★	6°	
		1.50	0.05	0.05	6.3	15°		MACR/L 3 150-R	★	★	★	☆	★	☆	★	★	★	★	★	★	★	★	★	★	★	6°	
		2.00	0.05	0.05	8.5	15°		MACR/L 3 200-R	★	★	★	☆	★	☆	★	★	★	★	★	★	★	★	★	★	★	6°	
		1.50	0.05	0.05	6.3	20°		MACR/L 3 150-R20	★	★	★		★	★	★	★	★	★	★	★	★	★	★	★	★	6°	
		2.00	0.05	0.05	8.5	20°		MACR/L 3 200-R20	★	★	★		★	★	★	★	★	★	★	★	★	★	★	★	★	6°	
	3	0.70	0.05	0.05	4.3			MACR/L 3 070-N	☆	★	☆	★	★		☆	★	☆	★	☆	★	☆	★	☆	★	6°		
		1.00	0.05	0.05	6.3			MACR/L 3 100-N	☆	★	☆	★	★		☆	★	☆	★	☆	★	☆	★	☆	★	6°		
		1.50	0.05	0.05	6.3			MACR/L 3 150-N	☆	★	☆	★	★		☆	★	☆	★	☆	★	☆	★	☆	★	6°		
		2.00	0.05	0.05	8.5			MACR/L 3 200-N	☆	★	☆	★	★		☆	★	☆	★	☆	★	☆	★	☆	★	6°		
	3	0.70	0.05	0.05	4.3	15°		MACR/L 3 070-L	☆	★	☆	★	★		☆	★	☆	★	☆	★	☆	★	☆	★	6°		
		1.00	0.05	0.05	6.3	15°		MACR/L 3 100-L	☆	★	☆	★	★		☆	★	☆	★	☆	★	☆	★	☆	★	6°		
		1.50	0.05	0.05	6.3	15°		MACR/L 3 150-L	☆	★	☆	★	★		☆	★	☆	★	☆	★	☆	★	☆	★	6°		
		2.00	0.05	0.05	8.5	15°		MACR/L 3 200-L	☆	★	☆	★	★		☆	★	☆	★	☆	★	☆	★	☆	★	6°		
	3	1.00	0.05	0.05	6.3			MACR/L 3 100-T	☆	★	☆	★	★		☆	★	☆	★	☆	★	☆	★	☆	★	6°		
		1.50	0.05	0.05	6.3			MACR/L 3 150-T	☆	★	☆	★	★		☆	★	☆	★	☆	★	☆	★	☆	★	6°		
		2.00	0.05	0.05	8.2			MACR/L 3 200-T	☆	★	☆	★	★		☆	★	☆	★	☆	★	☆	★	☆	★	6°		
		2.50	0.05	0.05	8.2			MACR/L 3 250-T	☆	★	☆	★	★		☆	★	☆	★	☆	★	☆	★	☆	★	6°		

SSC = Para corresponder ao SSC na ferramenta.

R = versão direita, L = versão esquerda

Tolerâncias:

	CWTOLL	CWTOLU	RETOLL	RETOLU
MACR/L-L	-0.020	0.020	-0.03	0.03
MACR/L-N	-0.020	0.020	-0.03	0.03
MACR/L-R	-0.020	0.020	-0.03	0.03
MACR/L-R20	-0.020	0.020	-0.03	0.03
MACR/L-T	-0.020	0.020	-0.03	0.03



B99



B136



B149



H36



H24



Pastilha CoroCut® XS para canais



B

C

							P	M	K	N	S	Dimensões, mm						
		SSC	CW	REL	RER	CDX	Código para pedido	1025	H13A	1025	H13A	1025	H13A	AN	CWTOLL	CWTOLU	RETOLL	RETOLU
Acabamento		3	0.50	0.05	0.05	1.3	MAGR/L 3 050	★	★	☆	★	★	★	6°	-0.025	0.025	-0.020	0.020
			0.75	0.05	0.05	2.5	MAGR/L 3 075	★	★	☆	★	★	★	6°	-0.025	0.025	-0.020	0.020
			1.00	0.05	0.05	2.7	MAGR/L 3 100	★	★	☆	★	★	★	6°	-0.025	0.025	-0.020	0.020
			1.25	0.05	0.05	2.7	MAGR/L 3 125	★	★	☆	★	★	★	6°	-0.025	0.025	-0.020	0.020
			1.50	0.05	0.05	3.7	MAGR/L 3 150	★	★	☆	★	★	★	6°	-0.025	0.025	-0.020	0.020
			1.75	0.05	0.05	3.7	MAGR/L 3 175	★	★	☆	★	★	★	6°	-0.025	0.025	-0.020	0.020
			2.00	0.05	0.05	3.7	MAGR/L 3 200	★	★	☆	★	★	★	6°	-0.025	0.025	-0.020	0.020
			2.50	0.05	0.05	3.7	MAGR/L 3 250	★	★	★	★	★	★	6°	-0.025	0.025	-0.020	0.020

D

Pastilha CoroCut® XS para perfilamento

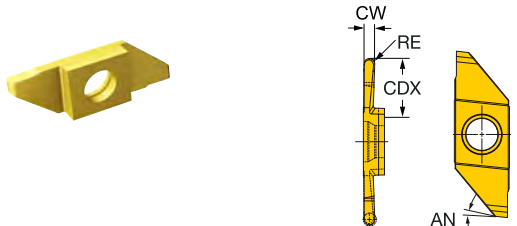

E

							P	M	K	N	S	Dimensões, mm				
		SSC	CW	RE	CDX	Código para pedido	1025	1025	1025	1025	AN	CWTOLL	CWTOLU	RETOLL	RETOLU	
Acabamento		3	0.80	0.40	3.8	MAPL 3 080	★	★	★	★	6°	-0.025	0.025	-0.025	0.025	
			1.25	0.63	5.0	MAPL 3 125	★	★	★	★	6°	-0.025	0.025	-0.025	0.025	
			1.60	0.80	7.5	MAPL 3 160	★	★	★	★	6°	-0.025	0.025	-0.025	0.025	
			2.50	1.25	7.5	MAPL 3 250	★	★	★	★	6°	-0.025	0.025	-0.025	0.025	

F

SSC = Para corresponder ao SSC na ferramenta.

R = versão direita, L = versão esquerda

G



Ferramenta convencional CoroCut® XS e QS para cortes e canais

Fixação por parafuso

Refrigeração de precisão

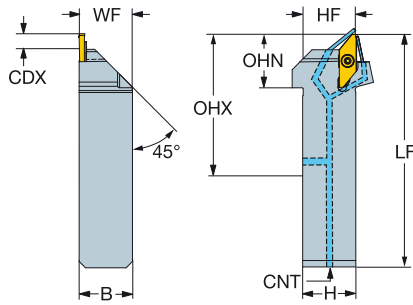

						Dimensões, mm											
SSC	CZC _{MS}	CDX	OHX	OHN	CNSC	Código para pedido	B	H	HBL	LF	WF	HF	CNT	BAR	KG	MIID	
3	20 x 20	7.3	45.0	25.0	3	QS-SMALR/L2020X3HP	20.0	20.0	25.1	94.1	20.0	20.0	G 1/8-28	150	0.24	MACL 3 200-N	
	25 x 25	7.3	50.0	25.0	3	QS-SMALR/L2525X3HP	25.0	25.0	25.1	109.1	25.0	25.0	G 1/8-28	150	0.44	MACL 3 200-N	

SSC = Para corresponder ao SSC na pastilha.

R = versão direita, L = versão esquerda

Componentes	
Parafuso da pastilha	Olhal
5513 027-01	5691 026-13

Para a lista completa de componentes, acesse www.sandvik.coromant.com



Cabeça CoroCut® XS para canais

Fixação por parafuso

CoroTurn® SL - Refrigeração interna

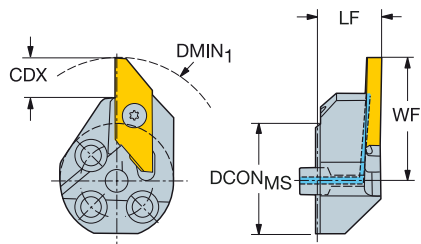

						Dimensões, mm						
SSC	CZC _{MS}	CDX	DMIN ₁	CNSC	Código para pedido	DCON _{MS}	LF	WF	BAR	NM	KG	MIID
3	25	8.2	42.0	1	570-25R/LSMAL3	25	14.0	26.8	10	1.2	0.08	MACR 3 200-N
	32	8.2	50.0	1	570-32R/LSMAL3	32	14.0	30.5	10	1.2	0.12	MACR 3 200-N

SSC = Para corresponder ao SSC na pastilha.

R = versão direita, L = versão esquerda

Nota: Pastilhas versão esquerda são usadas nos suportes versão direita, pastilhas versão direita são usadas nos suportes versão esquerda.

Componentes	
Parafuso	Tubo para refrigeração
5513 027-01	5691 041-01

Para a lista completa de componentes, acesse www.sandvik.coromant.com



T-Max Q-Cut®

Canais internos, canais frontais e saídas para retífica

Aplicação

- Canais internos
- Canais frontais
- Saídas para retífica

Área de aplicação ISO:







Características e benefícios

- Excelente acabamento superficial devido à tecnologia Wiper
- Sistema versátil e testado
- Pastilha 1 aresta com fixação em V para boa estabilidade
- Tailor Made



www.sandvik.coromant.com/tmaxqcut

Pastilhas

	Canais		Perfilamento	Saídas para retífica
				
	151.3-4G	151.3-7G	151.3-7P	N151.2-4U
Largura da pastilha, mm	1.85-8.00	3.00-6.00	3.00-6.00	2.00-3.00
Página	B102	B102	B103	B103

Ferramentas

	Saídas para retífica	Usinagem de canais frontais externos	Canais internos	Usinagem de canais frontais internos
Ferramentas convencionais	B104	B105		
Cabeças de corte CoroTurn® SL		B106	B107-B108	
Barras de mandrilar			B109-B110	B111



H35

Pastilha T-Max® Q-Cut para canais



TECHNOLOGY
Wiper

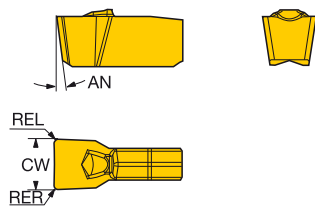

Canal frontal, canal interno e torneamento

C	Média	SSC	CW	REL	RER	Código para pedido	Dimensões, mm																						
							P			M			K			N			S			H							
							1125	1145	2135	1125	1145	2135	1125	1145	2135	1125	1145	2135	1125	1145	2135	AN	CWTOLL	CWTOLU	RETOLL	RETOLU			
		25	3.00	0.30	0.30	N151.3-300-25-7G	☆	☆	★	☆	☆	★	☆	☆	★	☆	☆	★	☆	☆	★	☆	☆	★	8°	0.000	0.100	-0.100	0.100
		30	4.00	0.40	0.40	N151.3-400-30-7G	☆	☆	★	☆	☆	★	☆	☆	★	☆	☆	★	☆	☆	★	☆	☆	★	8°	0.000	0.100	-0.100	0.100
		40	5.00	0.40	0.40	N151.3-500-40-7G	☆	☆	★	☆	☆	★	☆	☆	★	☆	☆	★	☆	☆	★	☆	☆	★	8°	0.000	0.100	-0.100	0.100
		50	6.00	0.40	0.40	N151.3-600-50-7G	☆	☆	★	☆	☆	★	☆	☆	★	☆	☆	★	☆	☆	★	☆	☆	★	8°	0.000	0.100	-0.100	0.100

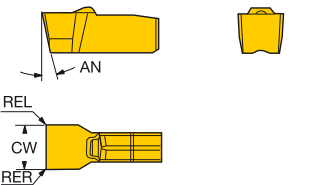
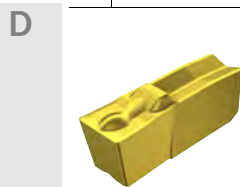

Canais internos

E	Acabamento	SSC	CW	REL	RER	Código para pedido	Dimensões, mm																						
							P			M			K			N			S			H							
							1125	1145	2135	1125	1145	H13A	1125	1145	2135	1125	1145	H13A	1125	1145	2135	AN	CWTOLL	CWTOLU	RETOLL	RETOLU			
		20	2.00	0.20	0.20	N151.3-200-20-4G	☆	☆	★	☆	☆	★	☆	☆	★	☆	☆	★	☆	☆	★	☆	☆	★	11°	-0.020	0.020	-0.050	0.050
		25	2.39	0.18	0.18	N151.3-A094-25-4G	★	☆	★	☆	☆	★	☆	☆	★	☆	☆	★	☆	☆	★	☆	☆	★	11°	-0.020	0.020	-0.051	0.051
			2.46	0.33	0.33	N151.3-A097-25-4G	★	☆	★	☆	☆	★	☆	☆	★	☆	☆	★	☆	☆	★	☆	☆	★	11°	-0.020	0.020	-0.051	0.051
			2.67	0.18	0.18	N151.3-A105-25-4G	☆	☆	★	☆	☆	★	☆	☆	★	☆	☆	★	☆	☆	★	☆	☆	★	11°	-0.020	0.020	-0.051	0.051
			2.79	0.33	0.33	N151.3-A110-25-4G	★	☆	★	☆	☆	★	☆	☆	★	☆	☆	★	☆	☆	★	☆	☆	★	11°	-0.020	0.020	-0.051	0.051
		30	3.00	0.20	0.20	N151.3-300-30-4G	☆	☆	★	☆	☆	★	☆	☆	★	☆	☆	★	☆	☆	★	☆	☆	★	11°	-0.020	0.020	-0.050	0.050
			3.18	0.18	0.18	N151.3-A125-30-4G	★	☆	★	☆	☆	★	☆	☆	★	☆	☆	★	☆	☆	★	☆	☆	★	11°	-0.020	0.020	-0.051	0.051
			3.61	0.33	0.33	N151.3-A142-30-4G	★	☆	★	☆	☆	★	☆	☆	★	☆	☆	★	☆	☆	★	☆	☆	★	11°	-0.020	0.020	-0.051	0.051
		40	4.00	0.20	0.20	N151.3-400-40-4G	☆	☆	★	☆	☆	★	☆	☆	★	☆	☆	★	☆	☆	★	☆	☆	★	11°	-0.020	0.020	-0.050	0.050
			3.96	0.18	0.18	N151.3-A156-40-4G	☆	☆	★	☆	☆	★	☆	☆	★	☆	☆	★	☆	☆	★	☆	☆	★	11°	-0.020	0.020	-0.051	0.051
			4.70	0.56	0.56	N151.3-A185-40-4G	★	☆	★	☆	☆	★	☆	☆	★	☆	☆	★	☆	☆	★	☆	☆	★	11°	-0.020	0.020	-0.051	0.051
			4.80	0.56	0.56	N151.3-A189-40-4G	★	☆	★	☆	☆	★	☆	☆	★	☆	☆	★	☆	☆	★	☆	☆	★	11°	-0.020	0.020	-0.051	0.051
		50	5.00	0.20	0.20	N151.3-500-50-4G	☆	☆	★	☆	☆	★	☆	☆	★	☆	☆	★	☆	☆	★	☆	☆	★	11°	-0.020	0.020	-0.050	0.050
		60	6.00	0.20	0.20	N151.3-600-60-4G	★	☆	★	☆	☆	★	☆	☆	★	☆	☆	★	☆	☆	★	☆	☆	★	9°	-0.020	0.020	-0.050	0.050

Para canais circlip

G	Acabamento	SSC	CW	REL	RER	Código para pedido	Dimensões, mm										
							P	M	K	N	S	AN	CWTOLL	CWTOLU	RETOLL	RETOLU	
							1125	1125	H13A	1125	H13A	H13A	1125	H13A	1125	H13A	
		20	1.85	0.10	0.10	N151.3-185-20-4G	★	★	☆	★	★	★	11°	0.090	0.130	-0.050	0.050
			2.15	0.15	0.15	N151.3-215-20-4G	★	★	☆	★	★	★	11°	0.090	0.130	-0.050	0.050
		25	2.65	0.15	0.15	N151.3-265-25-4G	★	★	☆	★	★	★	11°	0.090	0.130	-0.050	0.050

SSC = Para corresponder ao SSC no suporte.

N = neutra



B104



B109



B130



B149

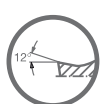

B147



H36



H35



H4

Pastilha T-Max® Q-Cut para saídas para retífica

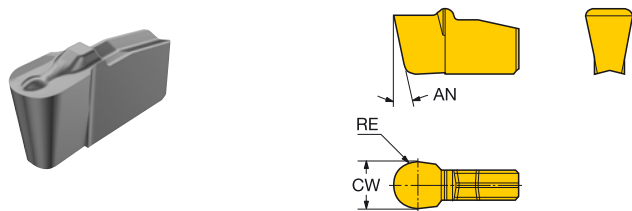

	SSC	CW	RE	REL	RER	Código para pedido	P	M	K	N	S	Dimensões, mm				
							525	H3A	H3A	H3A	H3A	AN	CWTOLL	CWTOLU	RETOLL	RETOLU
Média	20	2.00	1.00	1.00	1.00	N151.2-200-20-4U	*	*	*	*	*	7°	-0.020	0.020	-0.020	0.020
	25	3.00	1.50	1.50	1.50	N151.2-300-25-4U	*	*	*	*	*	7°	-0.020	0.020	-0.020	0.020

Pastilha T-Max® Q-Cut para perfilamento

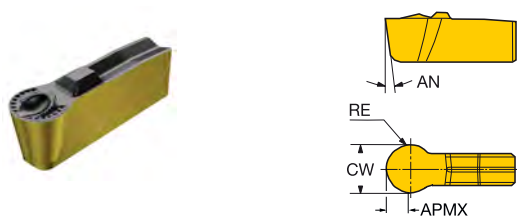

Perfilamento interno e canal frontal

	SSC	CW	RE	Código para pedido	P	M	K	N	S	H	Dimensões, mm				
					1125	2135	425	1125	2135	425	1125	2135	2135	AN	CWTOLL
Média	25	3.00	1.50	N151.3-300-25-7P	*	*	*	*	*	*	9°	-0.050	0.050	-0.020	0.020
	30	4.00	2.00	N151.3-400-30-7P	*	*	*	*	*	*	8°	-0.050	0.050	-0.020	0.020
	40	5.00	2.50	N151.3-500-40-7P	*	*	*	*	*	*	8°	-0.050	0.050	-0.020	0.020
	50	6.00	3.00	N151.3-600-50-7P	*	*	*	*	*	*	8°	-0.050	0.050	-0.020	0.020

SSC = Para corresponder ao SSC no suporte.

N = neutra



Ferramenta convencional T-Max® Q-Cut para saídas para retífica

Fixação por parafuso

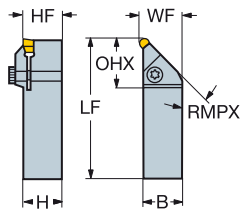

SSC	CZC _{MS}	CDX	RMPX	OHX	Código para pedido	Dimensões, mm						MIID	
						B	H	LF	WF	HF	NM		KG
20	25 x 25	1.0	45°	24.0	R/LS151.22-2525-20	25.0	25.0	150.0	25.3	25.0	2.5	0.74	N151.2-200-20- 4U
25	25 x 25	1.5	45°	27.0	R/LS151.22-2525-25	25.0	25.0	150.0	25.6	25.0	3.0	0.74	N151.2-300-25- 4U
30	25 x 25	2.0	45°	28.0	R/LS151.22-2525-30	25.0	25.0	150.0	25.8	25.0	3.5	0.73	N151.2-400-30- 4U
40	25 x 25	2.5	45°	31.0	R/LS151.22-2525-40	25.0	25.0	150.0	26.1	25.0	4.5	0.73	N151.2-500-40- 4U

SSC = Para corresponder ao SSC na pastilha.

R = versão direita, L = versão esquerda

Componentes	
Código para pedido	Parafuso de fixação
R/LS151.22-2525-20	3212 012-259
R/LS151.22-2525-25	3212 012-259
R/LS151.22-2525-30	3212 012-259
R/LS151.22-2525-40	3212 012-360

Para a lista completa de componentes, acesse www.sandvik.coromant.com



Ferramenta convencional T-Max® Q-Cut para canais frontais

Fixação por parafuso

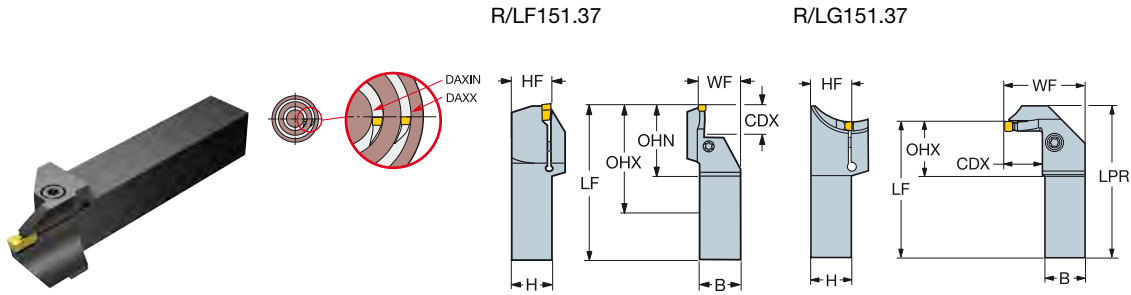

Curvatura B

SSC	CZC _{MS}	CDX	DAXIN	DAXX	OHX	Código para pedido	Dimensões, mm							NM	KG	MIID
							B	H	LPR	LF	WF	HF				
25	25 x 25	8.7	24.0	35.0	37.7	R/LF151.37-2525-024B25	25.0	25.0	150.0	26.0	25.0	3.2	0.73	N151.3-300-25-7G		
	25 x 25	8.7	29.0	40.0	37.7	R/LF151.37-2525-029B25	25.0	25.0	150.0	26.0	25.0	3.2	0.73	N151.3-300-25-7G		
	25 x 25	8.7	34.0	50.0	37.7	R/LF151.37-2525-034B25	25.0	25.0	150.0	26.0	25.0	3.2	0.72	N151.3-300-25-7G		
	25 x 25	15.0	64.0	100.0	37.7	RF151.37-2525-064B25	25.0	25.0	150.0	26.0	25.0	3.2	0.71	N151.3-300-25-7G		
	25 x 25	8.7	27.0	45.0	44.7	LF151.37-2525-027B30	25.0	25.0	150.0	26.0	25.0	3.3	0.70	N151.3-400-30-7G		
30	25 x 25	8.7	32.0	50.0	44.7	R/LF151.37-2525-032B30	25.0	25.0	150.0	26.0	25.0	3.3	0.74	N151.3-400-30-7G		
	25 x 25	20.0	42.0	70.0	44.7	RF151.37-2525-042B30	25.0	25.0	150.0	26.0	25.0	3.3	0.70	N151.3-400-30-7G		
	25 x 25	10.7	25.0	45.0	45.7	R/LF151.37-2525-025B40	25.0	25.0	150.0	26.0	25.0	3.4	0.73	N151.3-500-40-7G		
40	25 x 25	10.7	30.0	55.0	45.7	R/LF151.37-2525-030B40	25.0	25.0	150.0	26.0	25.0	3.4	0.71	N151.3-500-40-7G		
	25 x 25	10.7	23.0	45.0	46.7	RF151.37-2525-023B50	25.0	25.0	150.0	26.0	25.0	3.8	0.73	N151.3-600-50-7G		
50	25 x 25	8.7	27.0	45.0	26.0	R/LG151.37-2525-027B30	25.0	25.0	159.9	150.0	47.0	25.0	3.0	0.90	N151.3-400-30-7G	
	25 x 25	10.7	23.0	45.0	30.2	R/LG151.37-2525-023B50	25.0	25.0	164.2	150.0	47.0	25.0	3.0	0.90	N151.3-600-50-7G	

SSC = Para corresponder ao SSC na pastilha.

R = versão direita, L = versão esquerda

Componentes
Parafuso de fixação
3212 012-360

Para a lista completa de componentes, acesse www.sandvik.coromant.com



Cabeça T-Max® Q-Cut para canais

Fixação por parafuso

CoroTurn® SL - Refrigeração interna

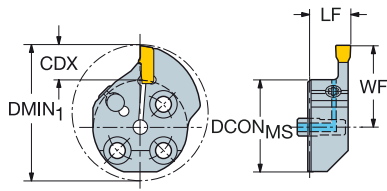

SSC	CZC _{MS}	CDX	DMIN ₁	OHX	CNSC	Código para pedido	Dimensões, mm					MIID	
							DCON _{MS}	LF	WF	BAR	NM		KG
20	25	8.0	35.6	13.0	1	570-25R/L151.3-08-20	25	14.0	22.1	10	3.0	0.07	N151.3-200-20-4G
	32	8.0	42.6	13.0	1	570-32R/L151.3-08-20	32	14.0	25.6	10	3.0	0.10	N151.3-200-20-4G
25	25	8.0	40.0	12.5	1	570-25R/L151.3-08-25	25	14.0	22.1	10	3.0	0.07	N151.3-300-25-7G
	32	7.0	41.6	12.5	1	570-32R/L151.3-07-25	32	14.0	24.6	10	3.0	0.10	N151.3-300-25-7G
30	25	8.0	40.7	12.5	1	570-25R/L151.3-08-30	25	14.0	22.1	10	3.0	0.07	N151.3-400-30-7G
	32	8.0	42.6	12.5	1	570-32R/L151.3-08-30	32	14.0	25.6	10	3.0	0.10	N151.3-400-30-7G
40	40	6.0	48.6	12.5	1	570-40R/L151.3-06-30	40	14.0	27.6	10	3.0	0.14	N151.3-400-30-7G
	32	10.0	48.0	11.5	1	570-32R/L151.3-10-40	32	14.0	27.6	10	3.0	0.10	N151.3-500-40-7G
40	40	9.0	51.6	11.5	1	570-40R/L151.3-09-40	40	14.0	30.6	10	3.0	0.15	N151.3-500-40-7G
	32	10.0	48.8	11.0	1	570-32R/L151.3-10-50	32	14.0	27.6	10	3.0	0.11	N151.3-600-50-7G
50	40	9.0	51.6	11.0	1	570-40R151.3-09-50	40	14.0	30.6	10	3.0	0.16	N151.3-600-50-7G
	32	13.0	47.6	10.0	1	570-32R/L151.3-13-60	32	14.0	30.6	10	3.0	0.11	N151.3-800-60-4G
60	40	12.0	54.6	10.0	1	570-40R/L151.3-12-60	40	14.0	33.6	10	3.0	0.16	N151.3-800-60-4G

SSC = Para corresponder ao SSC na pastilha.

R = versão direita, L = versão esquerda

Componentes				
SSC	CZC _{MS}	Parafuso de fixação	Tubo para refrigeração	Porca de fixação
20	25-32	5513 017-03	5691 041-01	5534 021-01
25	25-32	5513 017-03	5691 041-01	5534 021-01
30	25-40	5513 017-03	5691 041-03	5534 021-01
40	32-40	5513 017-03	5691 041-03	5534 021-01
50	32-40	5513 017-03	5691 041-03	5534 021-01
60	32-40	5513 017-03	5691 041-03	5534 021-01

Para a lista completa de componentes, acesse www.sandvik.coromant.com



B102



F2



H36



H35



H5



H2

Cabeça T-Max® Q-Cut para canais

Fixação por mecanismo tipo mola

CoroTurn® SL - Refrigeração interna

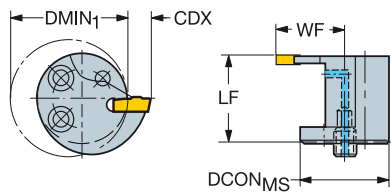

C

							Dimensões, mm					
SSC	CZC _{MS}	CDX	DMIN ₁	CNSC	Código para pedido	DCON _{MS}	LF	WF	BAR	KG	MIID	
20	16	8.5	25.0	1	R/LAG551.31-160808-20	16	8.0	16.5	10	0.03	N151.3-200-20-4G	
	16	3.5	20.0	1	R/LAG551.31-161603-20	16	16.0	11.5	10	0.03	N151.3-200-20-4G	
25	16	5.6	22.0	1	R/LAG551.31-161605-25	16	15.9	13.6	10	0.02	N151.3-265-25-4G	
	20	11.6	32.0	1	R/LAG551.31-201011-25	20	9.9	21.6	10	0.04	N151.3-265-25-4G	
	20	4.6	25.0	1	R/LAG551.31-202004-25	20	19.9	14.6	10	0.04	N151.3-265-25-4G	
30	20	4.5	25.0	1	R/LAG551.31-202004-30	20	19.5	14.5	10	0.04	N151.3-300-30-4G	
	25	14.5	40.0	1	R/LAG551.31-251214-30	25	12.0	27.0	10	0.06	N151.3-300-30-4G	
	25	6.5	32.0	1	R/LAG551.31-252506-30	25	24.5	19.0	10	0.08	N151.3-300-30-4G	
40	25	6.6	32.0	1	RAG551.31-252506-40	25	24.5	19.2	10	0.08	N151.3-400-40-4G	
	32	17.6	50.0	1	R/LAG551.31-321617-40	32	15.5	33.7	10	0.01	N151.3-400-40-4G	
	32	7.6	40.0	1	R/LAG551.31-323207-40	32	31.5	23.7	10	0.14	N151.3-400-40-4G	
	50	40	19.5	60.0	1	R/LAG551.31-402019-50	40	19.5	39.5	10	0.22	N151.3-500-50-4G

SSC = Para corresponder ao SSC na pastilha.

R = versão direita, L = versão esquerda

Acessórios (devem ser pedidos separadamente)

Chave da pastilha

5680 057-021

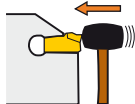
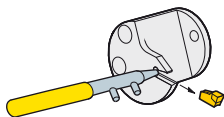

Não existem furos para montagem nas cabeças de corte intercambiáveis tipo T-Max Q-Cut® SL. Nesses casos, um pequeno martelo de borracha deve ser usado para encaixar a pastilha na sua posição final. A ponta da chave amarela deve ser usada para remover a pastilha.

F

G

H



Barra de mandrilar T-Max® Q-Cut para canais

Fixação por parafuso

Cilíndrica com canal para bucha EasyFix - Refrigeração interna

DSGN 1

2

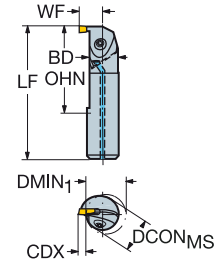
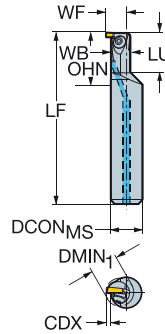
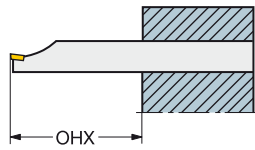

SSC	CZC _{MS}	CDX	DMIN ₁	LU	OHX	OHN	CNSC	DSGN	Código para pedido	Dimensões, mm							MIID
										DCON _{MS}	WB	LF	WF	BAR	NM	KG	
20	16	2.0	12.0	20.0	64.0	27.0	1	1	R/LAG151.32-16M12-20	16	9.5	150.0	10.0	10	2.5	0.22	N151.3-200-20-4G
25	16	4.0	15.0	20.0	64.0	27.0	1	1	R/LAG151.32-16M15-25	16	10.5	150.0	12.0	10	2.5	0.21	N151.3-265-25-4G
30	20	4.5	16.0	21.0	80.0	21.5	1	1	R/LAG151.32-20Q16-30	20	11.0	180.0	14.3	10	2.5	0.40	N151.3-300-30-4G
40	20	5.0	18.0	23.0	80.0	23.0	1	1	R/LAG151.32-20Q18-40	20	12.5	180.0	14.8	10	3.5	0.42	N151.3-400-40-4G
20	16	3.5	20.0		64.0	24.0	1	2	R/LAG151.32-16M-20	16		150.0	11.5	10	2.5	0.22	N151.3-200-20-4G
	20	4.5	25.0		80.0	30.0	1	2	R/LAG151.32-20Q-20	20		180.0	14.5	10	2.5	0.42	N151.3-200-20-4G
25	16	3.5	20.0		64.0	24.2	1	2	R/LAG151.32-16M-25	16		150.0	11.6	10	3.0	0.21	N151.3-265-25-4G
	20	4.6	25.0		80.0	30.0	1	2	R/LAG151.32-20Q-25	20		180.0	14.6	10	3.0	0.42	N151.3-265-25-4G
	25	6.1	32.0		100.0	32.2	1	2	R/LAG151.32-25R-25	25		200.0	18.6	10	3.0	0.70	N151.3-265-25-4G
30	20	4.5	25.0		80.0	32.2	1	2	R/LAG151.32-20Q-30	20		180.0	14.5	10	3.5	0.41	N151.3-300-30-4G
	25	6.0	32.0		100.0	30.0	1	2	R/LAG151.32-25R-30	25		200.0	18.5	10	3.5	0.70	N151.3-300-30-4G
40	25	6.1	32.0		100.0	32.2	1	2	R/LAG151.32-25R-40	25		200.0	18.5	10	4.5	0.69	N151.3-400-40-4G

SSC = Para corresponder ao SSC na pastilha.

R = versão direita, L = versão esquerda

Componentes
Parafuso de fixação
5512 031-03

Para a lista completa de componentes, acesse www.sandvik.coromant.com



Barra de mandrilar T-Max® Q-Cut para canais

Fixação por parafuso

Cilíndrica com planos - refrigeração interna

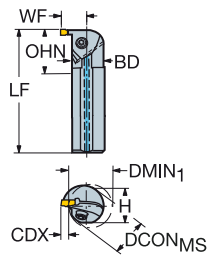
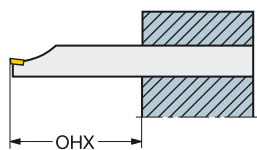

SSC	CZC _{MS}	CDX	DMIN ₁	OHX	OHN	CNSC	Código para pedido	Dimensões, mm							MIID
								DCON _{MS}	H	LF	WF	BAR	NM	KG	
25	32	7.1	40.0	128.0	36.3	1	R/LAG151.32-32S-25	32	30.0	250.0	23.1	10	3.0	1.41	N151.3-265-25-4G
30	32	7.0	40.0	128.0	36.2	1	R/LAG151.32-32S-30	32	30.0	250.0	23.0	10	3.5	1.43	N151.3-300-30-4G
40	32	7.1	40.0	128.0	36.3	1	R/LAG151.32-32S-40	32	30.0	250.0	23.1	10	4.5	1.42	N151.3-400-40-4G
	40	8.1	50.0	160.0	42.3	1	R/LAG151.32-40T-40	40	37.0	300.0	28.1	10	4.5	2.64	N151.3-400-40-4G
50	32	7.0	40.0	128.0	36.3	1	RAG151.32-32S-50	32	30.0	250.0	23.0	10	5.0	1.45	N151.3-500-50-4G
	40	8.0	50.0	160.0	42.3	1	RAG151.32-40T-50	40	37.0	300.0	28.0	10	5.0	2.63	N151.3-500-50-4G

SSC = Para corresponder ao SSC no suporte.

R = versão direita, L = versão esquerda

Componentes		
SSC	CZC _{MS}	Parafuso de fixação
25	32	5512 031-03
30	32	5512 031-03
40	32-40	3212 012-359
50	32-40	3212 012-359

Para a lista completa de componentes, acesse www.sandvik.coromant.com



Barra de mandrilar T-Max® Q-Cut para usinagem de canais frontais

Fixação por parafuso

Cilíndrica com planos - refrigeração interna

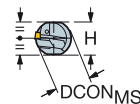
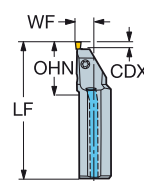
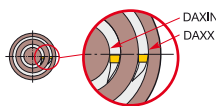
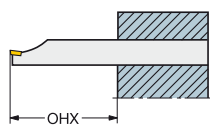

SSC	CZC _{MS}	CDX	DAXIN	DAXX	OHX	OHN	CNCS	Código para pedido	Dimensões, mm						BAR	NM	KG	MIID
									DCON _{MS}	H	LF	WF	HF					
25	25	5.3	18.0	101.0	62.5	31.4	1	R/LAF151.37-25-024A25	25	23.0	200.0	12.8	0.1	10	3.0	0.62	N151.3-300-25-7G	
30	25	5.3	16.0	101.0	62.5	31.4	1	R/LAF151.37-25-024A30	25	23.0	200.0	12.8	0.1	10	3.0	0.63	N151.3-400-30-7G	
	25	12.0	16.0	55.0	62.5	31.4	1	R/LAF151.37-25-025A30	25	23.0	200.0	12.8	0.1	10	3.5	0.62	N151.3-400-30-7G	
50	40	6.3	23.0	400.0	100.0	50.0	1	R/LAF151.37-40-035A50	40	37.0	300.0	20.8	0.1	10	5.0	2.40	N151.3-600-50-7G	
	40	15.0	23.0	80.0	100.0	50.0	1	R/LAF151.37-40-036A50	40	37.0	300.0	20.8	0.1	10	5.0	2.37	N151.3-600-50-7G	

SSC = Para corresponder ao SSC na pastilha.

R = versão direita, L = versão esquerda

Componentes		
SSC	CZC _{MS}	Parafuso de fixação
25	25	3212 012-257
30	25	3212 012-257
50	40	3212 012-359

Para a lista completa de componentes, acesse www.sandvik.coromant.com



B102



F2



G1



H36



H35



H5

CoroThread® 266

Para usinagem de canais circlip e outros canais rasos

Aplicação

- Canais rasos
- Usinagem de canais circlip
- Avanços baixos a médios

Área de aplicação ISO:



Características e benefícios

- Alta repetibilidade de indexação
- Solução estável com baixo risco de vibrações
- Solução de custo otimizado com três arestas de corte
- Canais internos e externos
- Arestas de corte vivas para canais de alta qualidade
- Fácil identificar a pastilha – a largura do canal está marcada na pastilha

www.sandvik.coromant.com/corothread266

Pastilhas

- Pastilhas na classe GC1135
- Geometria positiva para baixas forças de corte

Ferramentas

- Unidades de corte Coromant Capto®
- Ferramentas convencionais
- Barras de mandrilar
- Cabeças CoroTurn® SL

Fixação iLock™ segura

A pastilha com canais se encaixa rigidamente nos trilhos T do bolsão eliminando qualquer possibilidade de movimento causado pelas variações de força de corte.



As pastilhas podem ser usadas nos porta-ferramentas CoroThread 266. Para ângulo de inclinação correto, deve ser usado um calço de 0°.



B113



B114



H35

Pastilha CoroThread® 266 para canais

Para canais circlip e canais rasos

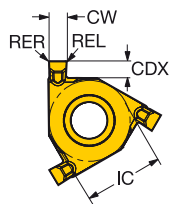

	CW	REL	RER	CDX	Código para pedido	Dimensões, mm				AN	CWTOLL	CWTOLU	RETOLL	RETOLU		
						P	M	K	N						S	
Média	16	1.10	0.08	0.08	1.3	254R/LG-16CC01-110	1135	1135	1135	1135	0°	0.050	0.130	-0.080	0.020	
		1.30	0.08	0.08	1.6	254R/LG-16CC01-130	*	*	*	*	0°	0.050	0.130	-0.080	0.020	
		1.60	0.08	0.08	1.9	254R/LG-16CC01-160	*	*	*	*	0°	0.050	0.130	-0.080	0.020	
		1.85	0.08	0.08	1.9	254R/LG-16CC01-185	*	*	*	*	0°	0.050	0.130	-0.080	0.020	
		2.15	0.08	0.08	1.9	254R/LG-16CC01-215	*	*	*	*	0°	0.050	0.130	-0.080	0.020	
		22	2.15	0.08	0.08	2.2	254R/LG-22CC01-215	*	*	*	*	0°	0.050	0.130	-0.080	0.020
			2.65	0.15	0.15	2.2	254R/LG-22CC01-265	*	*	*	*	0°	0.050	0.130	-0.080	0.020
			3.15	0.15	0.15	2.2	254R/LG-22CC01-315	*	*	*	*	0°	0.050	0.130	-0.080	0.020
			4.15	0.15	0.15	2.6	254R/LG-22CC01-415	*	*	*	*	0°	0.050	0.130	-0.080	0.020

SSC = Para corresponder ao SSC no suporte.

R = versão direita, L = versão esquerda

Nota!

A pastilha versão direita pode ser usada nos suportes internos versão esquerda e externos versão direita. As pastilhas versão esquerda podem ser usadas em suportes externos versão esquerda e internos versão direita.

Ao usar as barras de mandrilar CoroThread® 266 para essas pastilhas, deve ser usado um calço que proporcione ângulo de inclinação de 0°, veja a página C75



B114



B130



B149

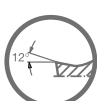

B148



H36



H26

Barra de mandrilar CoroThread® 266 para canais

Fixação por parafuso dedicada para canais circlip

Refrigeração interna

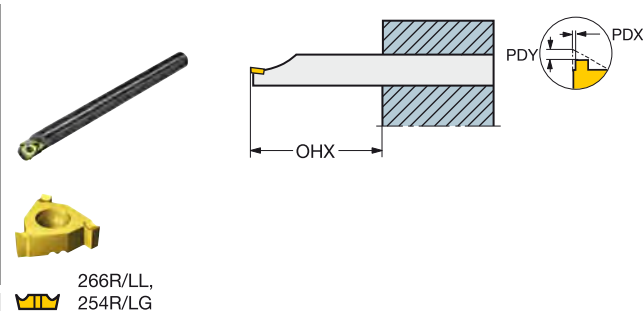

254R/LKF

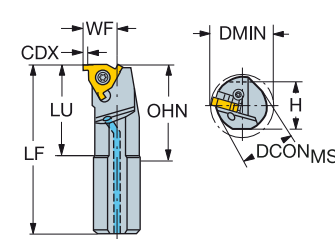

254R/LKF-R

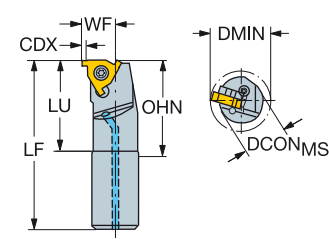

266R/LL,
254R/LG

Cilíndrica com planos

CZC _{MS}	CDX	DMIN ₁	LU	OHX	OHN	CNSC	Código para pedido	Dimensões, mm						MID		
								DCON _{MS}	H	LF	WF	BAR	NM		KG	
16	16	1.3	20.0	27.0	48.0	27.0	1	254R/LKF-16-16	16	15.0	201.0	12.0	10	3.0	0.30	254RG-16CC..
22	20	2.2	25.0	34.2	60.0	34.2	1	254R/LKF-20-22	20	18.0	251.0	15.0	10	5.0	0.53	254RG-22CC..

Cilíndrica

CZC _{MS}	CDX	DMIN ₁	LU	OHX	OHN	CNSC	Código para pedido	Dimensões, mm						MID	
								DCON _{MS}	LF	WF	BAR	NM	KG		
16	16	1.3	20.0	27.0	48.0	27.0	1	254R/LKF-16-16-R	16	125.0	12.0	10	3.0	0.20	254RG-16CC..
22	20	2.2	25.0	48.0	60.0	48.0	1	254R/LKF-20-22-R	20	141.0	15.0	10	5.0	0.32	254RG-22CC..

SSC = Para corresponder ao SSC na pastilha.

R = versão direita, L = versão esquerda

Sem uso de calços

Para valores PDX/PDY - consulte a página da pastilha.

Para barras com diâmetros maiores, use barras tipo 266R/LKF com calço 0°.

Quando usar as pastilhas CoroThread 266, tipo 254R/LG, para canais Circlip, a ferramenta convencional com haste cilíndrica versão direita deve ser usada com uma pastilha versão esquerda e a ferramenta convencional com haste cilíndrica versão esquerda com pastilha versão direita.

Componentes	
CZC _{MS}	Parafuso
16	5513 020-02
22	5513 020-07

Para a lista completa de componentes, acesse www.sandvik.coromant.com



CoroTurn® XS

Torneamento interno, usinagem de canais frontais e rosqueamento de peças pequenas

Aplicação

- Torneamento interno
- Cópia
- Mandrilamento reverso
- Perfilamento
- Canais
- Canais frontais
- Pré-corte
- Rosqueamento

Área de aplicação ISO:



Características e benefícios

- Otimizado para usinagem de alta qualidade de pequenas características
- Alta precisão e repetibilidade
- Sistema de fixação confiável e fácil de usar
- Ferramentas retificadas com precisão para alta repetibilidade
- Aumento da vida útil da ferramenta devido à minimização das microvibrações com adaptadores de hastes de metal duro cilíndricas
- A porca de fixação garante a troca rápida da ferramenta de corte com adaptadores de hastes de metal duro cilíndricas

www.sandvik.coromant.com/coroturnxs

Refrigeração interna

- Os adaptadores foram desenvolvidos com refrigeração interna de precisão
- Direção selecionável da refrigeração para melhor escoamento de cavacos e usinagem segura



Precisão de trava

Localização precisa na barra de mandril devido ao pino de localização



Ferramentas de corte

Torneamento	Mandrilamento reverso	Pré-corte	Canais	Canais frontais	Perfilamento	Rosqueamento
A272	A271	B116	B117	B120	B121	C60

Adaptadores

Coromant Capto®	Haste retangular	Haste cilíndrica com plano
F22	F33	F42

A

CORTES E CANAIS

Ferramentas de corte

Ferramenta CoroTurn® XS inteiriça de metal duro para pré-cortes

POR

B

C

	CZC _{MS}	CW	KCHL	KCHR	CHWL	CHWR	CDX	DMIN ₁	LU	OHX	Código para pedido	P	M	N	S	O	Dimensões, mm			
												1025	1025	1025	1025	1025	DCON _{MS}	WB	LF	WF
	5	1.00	45°	45°	0.04	0.04	0.7	5.2	15.0	18.0	CXS-05GX100-5215R/L	*	*	*	*	*	5	3.8	37.3	2.5
	5	1.00	45°	45°	0.04	0.04	0.7	5.2	20.0	23.0	CXS-05GX100-5220R	*	*	*	*	*	5	3.8	42.3	2.5
	5	1.00	45°	45°	0.04	0.04	0.7	5.2	25.0	28.0	CXS-05GX100-5225R/L	*	*	*	*	*	5	3.8	47.3	2.5
	5	1.00	45°	45°	0.04	0.04	0.7	5.2	30.0	33.0	CXS-05GX100-5230R	*	*	*	*	*	5	3.8	52.3	2.5

D

CZC_{MS} para corresponder com CZC_{WS} no adaptador.

R = versão direita, L = versão esquerda

Tolerâncias:

	CWTOLL	CWTOLU
CXS-xxGX	0.000	0.050

E

F

G

H

F2

B135

B149

H36

H22

B 116

Ferramenta CoroTurn® XS inteiriça de metal duro para canais

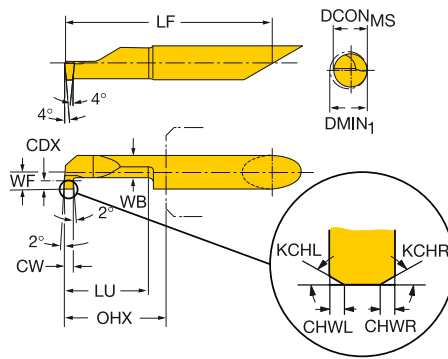

CZC _{MS}	CW	KCHL	KCHR	CHWL	CHWR	CDX	DMIN ₁	LU	OHX	Código para pedido	Dimensões, mm									
											P	M	N	S	H	O	DCON _{MS}	WB	LF	WF
4	0.50	45°	45°	0.04	0.04	0.4	2.0	9.0	12.0	CXS-04G050-2009L	*	*	*	*	*	*	4	1.2	26.3	2.0
4	0.50	45°	45°	0.04	0.04	0.4	2.0	12.0	15.0	CXS-04G050-2012R/L	*	*	*	*	*	*	4	1.2	29.3	2.0
4	0.70	45°	45°	0.04	0.04	0.6	3.0	16.0	19.0	CXS-04G070-3016R/L	*	*	*	*	*	*	4	2.0	33.3	2.0
4	0.78	45°	45°	0.04	0.04	0.8	4.2	10.0	13.0	CXS-04G078-4210R	*	*	*	*	*	*	4	3.0	27.3	2.0
4	0.78	45°	45°	0.04	0.04	0.8	4.2	15.0	18.0	CXS-04G078-4215R/L	*	*	*	*	*	*	4	3.0	32.3	2.0
4	0.78	45°	45°	0.04	0.04	0.8	4.2	20.0	23.0	CXS-04G078-4220R	*	*	*	*	*	*	4	3.0	37.3	2.0
4	0.78	45°	45°	0.04	0.04	0.8	4.2	25.0	28.0	CXS-04G078-4225R/L	*	*	*	*	*	*	4	3.0	42.3	2.0
4	1.00	45°	45°	0.04	0.04	0.8	4.2	10.0	13.0	CXS-04G100-4210R/L	*	*	*	*	*	*	4	3.0	27.3	2.0
4	1.00	45°	45°	0.04	0.04	0.8	4.2	15.0	18.0	CXS-04G100-4215R/L	*	*	*	*	*	*	4	3.0	32.3	2.0
4	1.00	45°	45°	0.04	0.04	0.8	4.2	20.0	23.0	CXS-04G100-4220R/L	*	*	*	*	*	*	4	3.0	37.3	2.0
5	0.78	45°	45°	0.04	0.04	1.0	5.2	10.0	13.0	CXS-05G078-5210R	*	*	*	*	*	*	5	3.8	32.3	2.5
5	0.78	45°	45°	0.04	0.04	1.0	5.2	15.0	18.0	CXS-05G078-5215R	*	*	*	*	*	*	5	3.8	37.3	2.5
5	0.78	45°	45°	0.04	0.04	1.0	5.2	20.0	23.0	CXS-05G078-5220R/L	*	*	*	*	*	*	5	3.8	42.3	2.5
5	0.78	45°	45°	0.04	0.04	1.0	5.2	25.0	28.0	CXS-05G078-5225L	*	*	*	*	*	*	5	3.8	47.3	2.5
5	0.78	45°	45°	0.04	0.04	1.0	5.2	30.0	33.0	CXS-05G078-5230R	*	*	*	*	*	*	5	3.8	52.3	2.5
5	0.78	45°	45°	0.04	0.04	1.0	5.2	35.0	38.0	CXS-05G078-5235R	*	*	*	*	*	*	5	3.8	57.3	2.5
5	1.00	45°	45°	0.04	0.04	1.0	5.2	10.0	13.0	CXS-05G100-5210R	*	*	*	*	*	*	5	3.8	32.3	2.5
5	1.00	45°	45°	0.04	0.04	1.0	5.2	20.0	23.0	CXS-05G100-5220R/L	*	*	*	*	*	*	5	3.8	42.3	2.5
5	1.00	45°	45°	0.04	0.04	1.0	5.2	30.0	33.0	CXS-05G100-5230R	*	*	*	*	*	*	5	3.8	52.3	2.5
5	1.00	45°	45°	0.04	0.04	1.0	5.2	35.0	38.0	CXS-05G100-5235R/L	*	*	*	*	*	*	5	3.8	57.3	2.5
5	1.17	45°	45°	0.04	0.04	1.0	5.2	10.0	13.0	CXS-05G117-5210R	*	*	*	*	*	*	5	3.8	32.3	2.5
5	1.17	45°	45°	0.04	0.04	1.0	5.2	15.0	18.0	CXS-05G117-5215L	*	*	*	*	*	*	5	3.8	37.3	2.5
5	1.17	45°	45°	0.04	0.04	1.0	5.2	20.0	23.0	CXS-05G117-5220R	*	*	*	*	*	*	5	3.8	42.3	2.5
5	1.17	45°	45°	0.04	0.04	1.0	5.2	30.0	33.0	CXS-05G117-5230L	*	*	*	*	*	*	5	3.8	52.3	2.5
5	1.17	45°	45°	0.04	0.04	1.0	5.2	35.0	38.0	CXS-05G117-5235R	*	*	*	*	*	*	5	3.8	57.3	2.5
5	1.50	45°	45°	0.04	0.04	1.0	5.2	10.0	13.0	CXS-05G150-5210R	*	*	*	*	*	*	5	3.8	32.3	2.5
5	1.50	45°	45°	0.04	0.04	1.0	5.2	15.0	18.0	CXS-05G150-5215R/L	*	*	*	*	*	*	5	3.8	37.3	2.5
5	1.50	45°	45°	0.04	0.04	1.0	5.2	20.0	23.0	CXS-05G150-5220R	*	*	*	*	*	*	5	3.8	42.3	2.5
5	1.50	45°	45°	0.04	0.04	1.0	5.2	25.0	28.0	CXS-05G150-5225L	*	*	*	*	*	*	5	3.8	47.3	2.5
5	1.50	45°	45°	0.04	0.04	1.0	5.2	30.0	33.0	CXS-05G150-5230R	*	*	*	*	*	*	5	3.8	52.3	2.5
5	1.00	45°	45°	0.04	0.04	1.0	5.2	35.0	38.0	CXS-05G150-5235R	*	*	*	*	*	*	5	3.8	57.3	2.5
5	1.57	45°	45°	0.04	0.04	1.0	5.2	15.0	18.0	CXS-05G157-5215R	*	*	*	*	*	*	5	3.8	37.3	2.5
5	1.57	45°	45°	0.04	0.04	1.0	5.2	20.0	23.0	CXS-05G157-5220R/L	*	*	*	*	*	*	5	3.8	42.3	2.5
5	1.57	45°	45°	0.04	0.04	1.0	5.2	25.0	28.0	CXS-05G157-5225L	*	*	*	*	*	*	5	3.8	47.3	2.5
5	1.57	45°	45°	0.04	0.04	1.0	5.2	30.0	33.0	CXS-05G157-5230R	*	*	*	*	*	*	5	3.8	52.3	2.5
5	1.57	45°	45°	0.04	0.04	1.0	5.2	10.0	13.0	CXS-05G198-5210L	*	*	*	*	*	*	5	3.8	32.3	2.5
5	1.98	45°	45°	0.04	0.04	1.0	5.2	15.0	18.0	CXS-05G198-5215R/L	*	*	*	*	*	*	5	3.8	37.3	2.5
5	1.98	45°	45°	0.04	0.04	1.0	5.2	25.0	28.0	CXS-05G198-5225R/L	*	*	*	*	*	*	5	3.8	47.3	2.5
5	1.98	45°	45°	0.04	0.04	1.0	5.2	30.0	33.0	CXS-05G198-5230R	*	*	*	*	*	*	5	3.8	52.3	2.5
5	2.00	45°	45°	0.04	0.04	1.0	5.2	10.0	13.0	CXS-05G200-5210R	*	*	*	*	*	*	5	3.8	32.3	2.5
5	2.00	45°	45°	0.04	0.04	1.0	5.2	20.0	23.0	CXS-05G200-5220R/L	*	*	*	*	*	*	5	3.8	42.3	2.5
5	2.00	45°	45°	0.04	0.04	1.0	5.2	30.0	33.0	CXS-05G200-5230R	*	*	*	*	*	*	5	3.8	52.3	2.5

CZC_{MS} para corresponder com CZC_{WS} no adaptador.

R = versão direita, L = versão esquerda

Tolerâncias:	CWTOLL	CWTOLU	RETOLL	RETOLU
CXS-xxG	0.00	0.05	0.00	0.02



Ferramenta CoroTurn® XS inteiriça de metal duro para canais

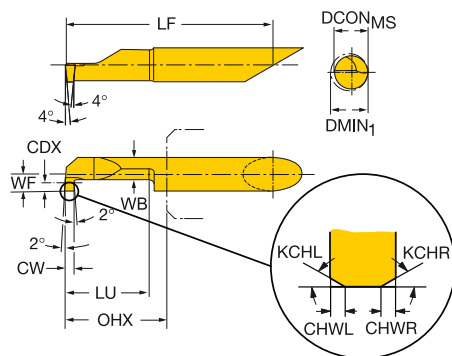

CZC _{MS}	CW	KCHL	KCHR	CHWL	CHWR	CDX	DMIN ₁	LU	OHX	Código para pedido	P	M	N	S	H	O	Dimensões, mm			
											1025	1025	1025	1025	7015	1025	DCON _{MS}	WB	LF	WF
6	0.78	45°	45°	0.04	0.04	1.8	6.2	10.0	13.0	CXS-06G078-6210R	*	*	*	*	*	*	6	4.0	32.3	3.0
6	0.78	45°	45°	0.04	0.04	1.8	6.2	15.0	18.0	CXS-06G078-6215R/L	*	*	*	*	*	*	6	4.0	37.3	3.0
6	0.78	45°	45°	0.04	0.04	1.8	6.2	25.0	28.0	CXS-06G078-6225R	*	*	*	*	*	*	6	4.0	47.3	3.0
6	0.78	45°	45°	0.04	0.04	1.8	6.2	30.0	33.0	CXS-06G078-6230L	*	*	*	*	*	*	6	4.0	52.3	3.0
6	0.78	45°	45°	0.04	0.04	1.8	6.2	35.0	38.0	CXS-06G078-6235R/L	*	*	*	*	*	*	6	4.0	57.3	3.0
6	1.00	45°	45°	0.04	0.04	1.8	6.2	10.0	13.0	CXS-06G100-6210R	*	*	*	*	*	*	6	4.0	32.3	3.0
6	1.00	45°	45°	0.04	0.04	1.8	6.2	15.0	18.0	CXS-06G100-6215L	*	*	*	*	*	*	6	4.0	37.3	3.0
6	1.00	45°	45°	0.04	0.04	1.8	6.2	15.0	18.0	CXS-06G100-6215R	*	*	*	*	*	*	6	4.0	37.3	3.0
6	1.00	45°	45°	0.04	0.04	1.8	6.2	25.0	28.0	CXS-06G100-6225R/L	*	*	*	*	*	*	6	4.0	47.3	3.0
6	1.00	45°	45°	0.04	0.04	1.8	6.2	35.0	38.0	CXS-06G100-6235R	*	*	*	*	*	*	6	4.0	57.3	3.0
6	1.00	45°	45°	0.04	0.04	1.8	6.2	40.0	43.0	CXS-06G100-6240R	*	*	*	*	*	*	6	4.0	62.3	3.0
6	1.17	45°	45°	0.04	0.04	1.8	6.2	10.0	13.0	CXS-06G117-6210R	*	*	*	*	*	*	6	4.0	32.3	3.0
6	1.17	45°	45°	0.04	0.04	1.8	6.2	15.0	18.0	CXS-06G117-6215R	*	*	*	*	*	*	6	4.0	37.3	3.0
6	1.17	45°	45°	0.04	0.04	1.8	6.2	20.0	23.0	CXS-06G117-6220R	*	*	*	*	*	*	6	4.0	42.3	3.0
6	1.17	45°	45°	0.04	0.04	1.8	6.2	25.0	28.0	CXS-06G117-6225R/L	*	*	*	*	*	*	6	4.0	47.3	3.0
6	1.17	45°	45°	0.04	0.04	1.8	6.2	30.0	33.0	CXS-06G117-6230R	*	*	*	*	*	*	6	4.0	52.3	3.0
6	1.17	45°	45°	0.04	0.04	1.8	6.2	40.0	43.0	CXS-06G117-6240R/L	*	*	*	*	*	*	6	4.0	62.3	3.0
6	1.50	45°	45°	0.04	0.04	1.8	6.2	10.0	13.0	CXS-06G150-6210R	*	*	*	*	*	*	6	4.0	32.3	3.0
6	1.50	45°	45°	0.04	0.04	1.8	6.2	15.0	18.0	CXS-06G150-6215L	*	*	*	*	*	*	6	4.0	37.3	3.0
6	1.50	45°	45°	0.04	0.04	1.8	6.2	15.0	18.0	CXS-06G150-6215R	*	*	*	*	*	*	6	4.0	37.3	3.0
6	1.50	45°	45°	0.04	0.04	1.8	6.2	25.0	28.0	CXS-06G150-6225R/L	*	*	*	*	*	*	6	4.0	47.3	3.0
6	1.50	45°	45°	0.04	0.04	1.8	6.2	30.0	33.0	CXS-06G150-6230R	*	*	*	*	*	*	6	4.0	52.3	3.0
6	1.50	45°	45°	0.04	0.04	1.8	6.2	35.0	38.0	CXS-06G150-6235R/L	*	*	*	*	*	*	6	4.0	57.3	3.0
6	1.57	45°	45°	0.04	0.04	1.8	6.2	10.0	13.0	CXS-06G157-6210R	*	*	*	*	*	*	6	4.0	32.3	3.0
6	1.57	45°	45°	0.04	0.04	1.8	6.2	15.0	18.0	CXS-06G157-6215R/L	*	*	*	*	*	*	6	4.0	37.3	3.0
6	1.57	45°	45°	0.04	0.04	1.8	6.2	25.0	28.0	CXS-06G157-6225R	*	*	*	*	*	*	6	4.0	47.3	3.0
6	1.57	45°	45°	0.04	0.04	1.8	6.2	30.0	33.0	CXS-06G157-6230L	*	*	*	*	*	*	6	4.0	52.3	3.0
6	1.57	45°	45°	0.04	0.04	1.8	6.2	35.0	38.0	CXS-06G157-6235R/L	*	*	*	*	*	*	6	4.0	57.3	3.0
6	1.98	45°	45°	0.04	0.04	1.8	6.2	10.0	13.0	CXS-06G198-6210R	*	*	*	*	*	*	6	4.0	32.3	3.0
6	1.98	45°	45°	0.04	0.04	1.8	6.2	15.0	18.0	CXS-06G198-6215R	*	*	*	*	*	*	6	4.0	37.3	3.0
6	1.98	45°	45°	0.04	0.04	1.8	6.2	25.0	28.0	CXS-06G198-6225R	*	*	*	*	*	*	6	4.0	47.3	3.0
6	1.98	45°	45°	0.04	0.04	1.8	6.2	35.0	38.0	CXS-06G198-6235R/L	*	*	*	*	*	*	6	4.0	57.3	3.0
6	2.00	45°	45°	0.04	0.04	1.8	6.2	10.0	13.0	CXS-06G200-6210R	*	*	*	*	*	*	6	4.0	32.3	3.0
6	2.00	45°	45°	0.04	0.04	1.8	6.2	15.0	18.0	CXS-06G200-6215R/L	*	*	*	*	*	*	6	4.0	37.3	3.0
6	2.00	45°	45°	0.04	0.04	1.8	6.2	25.0	28.0	CXS-06G200-6225R/L	*	*	*	*	*	*	6	4.0	47.3	3.0
6	2.00	45°	45°	0.04	0.04	1.8	6.2	30.0	33.0	CXS-06G200-6230R/L	*	*	*	*	*	*	6	4.0	52.3	3.0

CZC_{MS} para corresponder com CZC_{WS} no adaptador.

R = versão direita, L = versão esquerda

Tolerâncias:	CWTOLL	CWTOLU	RETOLL	RETOLU
CXS-xxG	0.00	0.05	0.00	0.02



Ferramenta CoroTurn® XS inteiriça de metal duro para canais

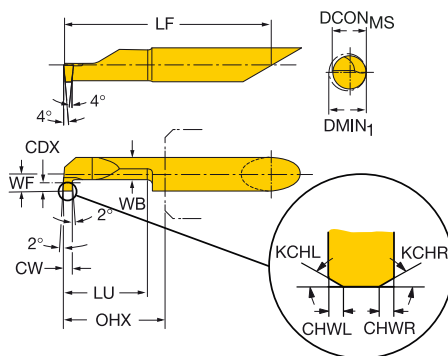

CZC _{MS}	CW	KCHL	KCHR	CHWL	CHWR	CDX	DMIN ₁	LU	OHX	Código para pedido	Dimensões, mm								
											P	M	N	S	H	O	DCON _{MS}	WB	LF
7	0.78	45°	45°	0.04	0.04	2.5	7.2	10.0	13.0	CXS-07G078-7210R	*	*	*	*	*	7	4.3	32.3	3.5
7	0.78	45°	45°	0.04	0.04	2.5	7.2	15.0	18.0	CXS-07G078-7215R/L	*	*	*	*	*	7	4.3	37.3	3.5
7	0.78	45°	45°	0.04	0.04	2.5	7.2	25.0	28.0	CXS-07G078-7225R	*	*	*	*	*	7	4.3	47.3	3.5
7	0.78	45°	45°	0.04	0.04	2.5	7.2	30.0	33.0	CXS-07G078-7230R/L	*	*	*	*	*	7	4.3	52.3	3.5
7	0.78	45°	45°	0.04	0.04	2.5	7.2	35.0	38.0	CXS-07G078-7235R/L	*	*	*	*	*	7	4.3	57.3	3.5
7	0.78	45°	45°	0.04	0.04	2.5	7.2	40.0	43.0	CXS-07G078-7240R	*	*	*	*	*	7	4.3	62.3	3.5
7	1.00	45°	45°	0.04	0.04	2.5	7.2	10.0	13.0	CXS-07G100-7210R	*	*	*	*	*	7	4.3	32.3	3.5
7	1.00	45°	45°	0.04	0.04	2.5	7.2	15.0	18.0	CXS-07G100-7215R/L	*	*	*	*	*	7	4.3	37.3	3.5
7	1.00	45°	45°	0.04	0.04	2.5	7.2	25.0	28.0	CXS-07G100-7225R/L	*	*	*	*	*	7	4.3	47.3	3.5
7	1.00	45°	45°	0.04	0.04	2.5	7.2	30.0	33.0	CXS-07G100-7230R/L	*	*	*	*	*	7	4.3	52.3	3.5
7	1.00	45°	45°	0.04	0.04	2.5	7.2	35.0	38.0	CXS-07G100-7235R	*	*	*	*	*	7	4.3	57.3	3.5
7	1.17	45°	45°	0.04	0.04	2.5	7.2	40.0	43.0	CXS-07G100-7240R	*	*	*	*	*	7	4.3	62.3	3.5
7	1.17	45°	45°	0.04	0.04	2.5	7.2	10.0	13.0	CXS-07G117-7210R	*	*	*	*	*	7	4.3	32.3	3.5
7	1.17	45°	45°	0.04	0.04	2.5	7.2	15.0	18.0	CXS-07G117-7215R	*	*	*	*	*	7	4.3	37.3	3.5
7	1.17	45°	45°	0.04	0.04	2.5	7.2	25.0	28.0	CXS-07G117-7225R	*	*	*	*	*	7	4.3	47.3	3.5
7	1.17	45°	45°	0.04	0.04	2.5	7.2	30.0	33.0	CXS-07G117-7230R	*	*	*	*	*	7	4.3	52.3	3.5
7	1.17	45°	45°	0.04	0.04	2.5	7.2	35.0	38.0	CXS-07G117-7235R	*	*	*	*	*	7	4.3	57.3	3.5
7	1.17	45°	45°	0.04	0.04	2.5	7.2	40.0	43.0	CXS-07G117-7240R/L	*	*	*	*	*	7	4.3	62.3	3.5
7	1.50	45°	45°	0.04	0.04	2.5	7.2	10.0	13.0	CXS-07G150-7210R	*	*	*	*	*	7	4.3	32.3	3.5
7	1.50	45°	45°	0.04	0.04	2.5	7.2	15.0	18.0	CXS-07G150-7215R/L	*	*	*	*	*	7	4.3	37.3	3.5
7	1.50	45°	45°	0.04	0.04	2.5	7.2	25.0	28.0	CXS-07G150-7225R/L	*	*	*	*	*	7	4.3	47.3	3.5
7	1.50	45°	45°	0.04	0.04	2.5	7.2	35.0	38.0	CXS-07G150-7235R	*	*	*	*	*	7	4.3	57.3	3.5
7	1.50	45°	45°	0.04	0.04	2.5	7.2	40.0	43.0	CXS-07G150-7240R/L	*	*	*	*	*	7	4.3	62.3	3.5
7	1.57	45°	45°	0.04	0.04	2.5	7.2	10.0	13.0	CXS-07G157-7210R	*	*	*	*	*	7	4.3	32.3	3.5
7	1.57	45°	45°	0.04	0.04	2.5	7.2	15.0	18.0	CXS-07G157-7215R/L	*	*	*	*	*	7	4.3	37.3	3.5
7	1.57	45°	45°	0.04	0.04	2.5	7.2	20.0	23.0	CXS-07G157-7220L	*	*	*	*	*	7	4.3	42.3	3.5
7	1.57	45°	45°	0.04	0.04	2.5	7.2	25.0	28.0	CXS-07G157-7225R	*	*	*	*	*	7	4.3	47.3	3.5
7	1.57	45°	45°	0.04	0.04	2.5	7.2	35.0	38.0	CXS-07G157-7235R/L	*	*	*	*	*	7	4.3	57.3	3.5
7	1.57	45°	45°	0.04	0.04	2.5	7.2	40.0	43.0	CXS-07G157-7240L	*	*	*	*	*	7	4.3	62.3	3.5
7	1.98	45°	45°	0.04	0.04	2.5	7.2	10.0	13.0	CXS-07G198-7210R	*	*	*	*	*	7	4.3	32.3	3.5
7	1.98	45°	45°	0.04	0.04	2.5	7.2	15.0	18.0	CXS-07G198-7215R/L	*	*	*	*	*	7	4.3	37.3	3.5
7	1.98	45°	45°	0.04	0.04	2.5	7.2	30.0	33.0	CXS-07G198-7230L	*	*	*	*	*	7	4.3	52.3	3.5
7	1.98	45°	45°	0.04	0.04	2.5	7.2	35.0	38.0	CXS-07G198-7235R/L	*	*	*	*	*	7	4.3	57.3	3.5
7	2.00	45°	45°	0.04	0.04	2.5	7.2	10.0	13.0	CXS-07G200-7210R	*	*	*	*	*	7	4.3	32.3	3.5
7	2.00	45°	45°	0.04	0.04	2.5	7.2	15.0	18.0	CXS-07G200-7215R/L	*	*	*	*	*	7	4.3	37.3	3.5
7	2.00	45°	45°	0.04	0.04	2.5	7.2	20.0	23.0	CXS-07G200-7220R	*	*	*	*	*	7	4.3	42.3	3.5
7	2.00	45°	45°	0.04	0.04	2.5	7.2	25.0	28.0	CXS-07G200-7225R/L	*	*	*	*	*	7	4.3	47.3	3.5
7	2.00	45°	45°	0.04	0.04	2.5	7.2	35.0	38.0	CXS-07G200-7235R/L	*	*	*	*	*	7	4.3	57.3	3.5

CZC_{MS} para corresponder com CZC_{WS} no adaptador.

R = versão direita, L = versão esquerda

Tolerâncias:				
	CWTOLL	CWTOLU	RETOLL	RETOLU
CXS-xxG	0.00	0.05	0.00	0.02



F2



B135



B149



H36



H22



A

Ferramenta CoroTurn® XS inteiriça de metal duro para canais frontais

B

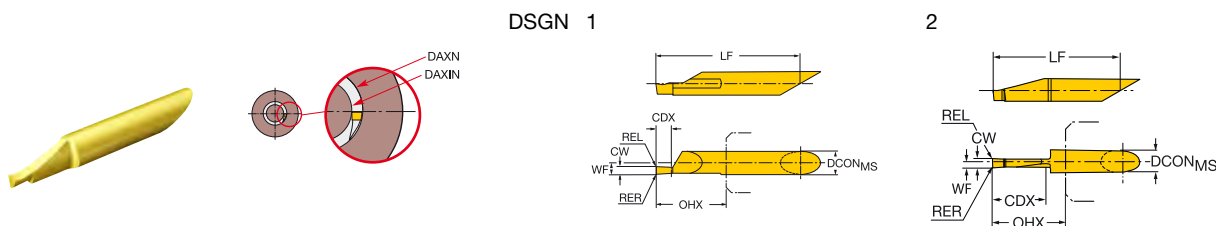

Curvatura A

C

CZC _{MS}	CW	REL	RER	CDX	DAXIN	OHX	DSGN	Código para pedido	P M N S O				Dimensões, mm								
									1025	1025	1025	1025	DCON _{MS}	LF	WF	CWTOLL	CWTOLU	RETOLL	RETOLU		
	6	1.00	0.15	0.15	2.0	4.2	18.0	1	CXS-06F100-6215AR/L	*	*	*	*	*	6	37.3	3.0	0.000	0.050	-0.02	0.02
	6	1.50	0.15	0.15	3.0	3.2	18.0	1	CXS-06F150-6215AR/L	*	*	*	*	*	6	37.3	3.0	0.000	0.050	-0.02	0.02
	6	2.00	0.15	0.15	4.0	2.2	18.0	1	CXS-06F200-6215AR/L	*	*	*	*	*	6	37.3	3.0	0.000	0.050	-0.02	0.02
	6	2.50	0.15	0.15	5.0	1.2	18.0	1	CXS-06F250-6215AR/L	*	*	*	*	*	6	37.3	3.0	0.000	0.050	-0.02	0.02
	6	3.00	0.15	0.15	6.0	0.2	18.0	1	CXS-06F300-6215AR/L	*	*	*	*	*	6	37.3	3.0	0.000	0.050	-0.02	0.02
	8	2.00	0.20	0.20	15.0	11.0	20.0	2	CXS-08F200-8015AR/L	*	*	*	*	*	8	44.3	1.6	0.000	0.050	-0.02	0.02
	8	2.50	0.20	0.20	10.0	5.0	15.0	2	CXS-08F250-8010AR/L	*	*	*	*	*	8	39.3	1.8	0.000	0.050	-0.02	0.02
	8	3.00	0.20	0.20	10.0	4.0	15.0	2	CXS-08F300-8010AR/L	*	*	*	*	*	8	39.3	2.1	0.000	0.050	-0.02	0.02
	8	3.00	0.20	0.20	15.0	9.0	20.0	2	CXS-08F300-8015AR/L	*	*	*	*	*	8	44.3	2.1	0.000	0.050	-0.02	0.02
	8	4.00	0.20	0.20	10.0	2.0	15.0	2	CXS-08F400-8010AR/L	*	*	*	*	*	8	39.3	2.5	0.000	0.050	-0.02	0.02
	8	4.00	0.20	0.20	15.0	7.0	20.0	2	CXS-08F400-8015AR/L	*	*	*	*	*	8	44.3	2.5	0.000	0.050	-0.02	0.02
	10	3.00	0.20	0.20	20.0	14.0	28.0	2	CXS-10F300-10020AR/L	*	*	*	*	*	10	52.3	2.1	0.000	0.050	-0.02	0.02
	10	3.00	0.20	0.20	25.0	19.0	33.0	2	CXS-10F300-10025AR/L	*	*	*	*	*	10	57.3	2.1	0.000	0.050	-0.02	0.02
	10	3.00	0.20	0.20	30.0	24.0	38.0	2	CXS-10F300-10030AR/L	*	*	*	*	*	10	62.3	2.1	0.000	0.050	-0.02	0.02
	10	4.00	0.20	0.20	20.0	12.0	28.0	2	CXS-10F400-10020AR/L	*	*	*	*	*	10	52.3	2.7	0.000	0.050	-0.02	0.02
	10	4.00	0.20	0.20	25.0	17.0	33.0	2	CXS-10F400-10025AR/L	*	*	*	*	*	10	57.3	2.7	0.000	0.050	-0.02	0.02
	10	4.00	0.20	0.20	30.0	22.0	38.0	2	CXS-10F400-10030AR/L	*	*	*	*	*	10	62.3	2.7	0.000	0.050	-0.02	0.02
	10	5.00	0.20	0.20	20.0	10.0	28.0	2	CXS-10F500-10020AR/L	*	*	*	*	*	10	52.3	3.1	0.000	0.050	-0.02	0.02
	10	5.00	0.20	0.20	25.0	15.0	33.0	2	CXS-10F500-10025AR/L	*	*	*	*	*	10	57.3	3.1	0.000	0.050	-0.02	0.02
	10	5.00	0.20	0.20	30.0	20.0	38.0	2	CXS-10F500-10030AR/L	*	*	*	*	*	10	62.3	3.1	0.000	0.050	-0.02	0.02

F

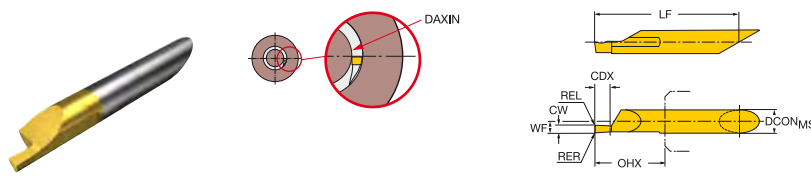

Curvatura B

G

CZC _{MS}	CW	REL	RER	CDX	DAXIN	OHX	Código para pedido	P M N S O				Dimensões, mm									
								1025	1025	1025	1025	DCON _{MS}	LF	WF	CWTOLL	CWTOLU	RETOLL	RETOLU			
	6	1.00	0.15	0.15	2.0	4.2	18.0	1	CXS-06F100-6215BR/L	*	*	*	*	*	6	37.3	3.0	0.000	0.050	-0.02	0.02
	6	1.50	0.15	0.15	3.0	3.2	18.0	1	CXS-06F150-6215BR/L	*	*	*	*	*	6	37.3	3.0	0.000	0.050	-0.02	0.02
	6	2.00	0.15	0.15	4.0	2.2	18.0	1	CXS-06F200-6215BR/L	*	*	*	*	*	6	37.3	3.0	0.000	0.050	-0.02	0.02
	6	2.50	0.15	0.15	5.0	1.2	18.0	1	CXS-06F250-6215BR/L	*	*	*	*	*	6	37.3	3.0	0.000	0.050	-0.02	0.02
	6	3.00	0.15	0.15	6.0	0.2	18.0	1	CXS-06F300-6215BR/L	*	*	*	*	*	6	37.3	3.0	0.000	0.050	-0.02	0.02

H

CZC_{MS} para corresponder com CZC_{WS} no adaptador.

R = versão direita, L = versão esquerda



Ferramenta CoroTurn® XS inteiriça de metal duro

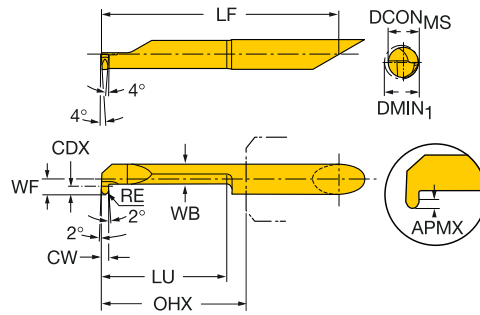

CZC _{MS}	CW	RE	CDX	DMIN ₁	LU	OHX	Código para pedido	P M N S O				Dimensões, mm				
								1025	1025	1025	1025	DCON _{MS}	WB	LF	WF	
								★	★	★	★	★	★	★	★	
4	1.17	0.58	0.8	4.2	15.0	18.0	CXS-04R058-4215R	★	★	★	★	★	4	3.0	32.3	2.0
4	1.00	0.50	0.8	4.2	15.0	18.0	CXS-04R100-4215R/L	★	★	★	★	★	4	3.0	32.3	2.0
5	1.17	0.58	1.0	5.2	20.0	23.0	CXS-05R058-5220R/L	★	★	★	★	★	5	3.8	42.3	2.5
5	1.63	0.81	1.0	5.2	20.0	23.0	CXS-05R081-5220R	★	★	★	★	★	5	3.8	42.3	2.5
5	1.98	0.99	1.0	5.2	20.0	23.0	CXS-05R099-5220R	★	★	★	★	★	5	3.8	42.3	2.5
5	1.00	0.50	1.0	5.2	20.0	23.0	CXS-05R100-5220R	★	★	★	★	★	5	3.8	42.3	2.5
5	1.50	0.75	1.0	5.2	20.0	23.0	CXS-05R150-5220R	★	★	★	★	★	5	3.8	42.3	2.5
5	2.00	1.00	1.0	5.2	20.0	23.0	CXS-05R200-5220R	★	★	★	★	★	5	3.8	42.3	2.5
6	1.17	0.58	1.8	6.2	25.0	28.0	CXS-06R058-6225R/L	★	★	★	★	★	6	4.0	47.3	3.0
6	1.63	0.81	1.8	6.2	25.0	28.0	CXS-06R081-6225R	★	★	★	★	★	6	4.0	47.3	3.0
6	1.98	0.99	1.8	6.2	25.0	28.0	CXS-06R099-6225R	★	★	★	★	★	6	4.0	47.3	3.0
6	1.00	0.50	1.8	6.2	25.0	28.0	CXS-06R100-6225R/L	★	★	★	★	★	6	4.0	47.3	3.0
6	1.50	0.75	1.8	6.2	25.0	28.0	CXS-06R150-6225R	★	★	★	★	★	6	4.0	47.3	3.0
6	2.00	1.00	1.8	6.2	25.0	28.0	CXS-06R200-6225R/L	★	★	★	★	★	6	4.0	47.3	3.0
7	1.17	0.58	2.5	7.2	30.0	33.0	CXS-07R058-7230R	★	★	★	★	★	7	4.3	52.3	3.5
7	1.63	0.81	2.5	7.2	30.0	33.0	CXS-07R081-7230R	★	★	★	★	★	7	4.3	52.3	3.5
7	1.98	0.99	2.5	7.2	30.0	33.0	CXS-07R099-7230R	★	★	★	★	★	7	4.3	52.3	3.5
7	1.00	0.50	2.5	7.2	30.0	33.0	CXS-07R100-7230R/L	★	★	★	★	★	7	4.3	52.3	3.5
7	1.50	0.75	2.5	7.2	30.0	33.0	CXS-07R150-7230R	★	★	★	★	★	7	4.3	52.3	3.5
7	2.00	1.00	2.5	7.2	30.0	33.0	CXS-07R200-7230R/L	★	★	★	★	★	7	4.3	52.3	3.5

CZC_{MS} para corresponder com CZC_{WS} no adaptador.

R = versão direita, L = versão esquerda

Tolerâncias:				
	CWTOLL	CWTOLU	RETOLL	RETOLU
CXS-xxR	0.000	0.050	-0.02	0.02



CoroCut® MB

Para usinagem interna com alta precisão

Aplicação

- Para usinagem interna de furos pequenos
- Pré-corte
- Canais
- Canais frontais
- Perfilamento
- Torneamento
- Cópia
- Mandrilamento reverso
- Rosqueamento

Área de aplicação ISO:



Características e benefícios

- Usinagem sem vibrações
- Set-up rápido tanto da ferramenta quanto da pastilha
- Estabilidade e alta precisão entre a interface e o porta-ferramenta
- Ferramenta de corte intercambiável com montagem frontal
- Arestas de corte vivas
- Geometrias e classes para todos os materiais
- Hastes de metal duro para longos balanços
- Refrigeração interna
- Fixação Easy Fix
- Ferramentas para usinagem de canais em uma ampla gama de larguras e raios de canto – também para canais padronizados como O-rings e canais circlip.



www.sandvik.coromant.com/corocutmb

EasyFix

Use barras de mandrilar cilíndricas de aço e de metal duro com buchas EasyFix para obter a altura de centro exata.









Barras de mandrilar CoroCut® MB

Para estabilidade e acessibilidade, as barras foram desenhadas com cabeça excêntrica e seção cruzada oval.

Adaptadores

- Coromant Capto® para adaptador CoroTurn® XS
Veja página F22.
- Haste retangular para adaptador CoroTurn® XS
Veja página F33.
- Adaptador CoroTurn® XS de haste cilíndrica com planos
Veja página F42.

Pastilhas

	Pré-corte	Canais	Canais frontais	Perfilamento	Torneamento	Cópia	Mandrilamento reverso	Rosqueamento
								
	MB-..GX	MB-..G	MB-F	MB-..R	MB..T045	MB..TE93	MB..B	MB..TH
Largura da pastilha, mm	1.00	0.73-3.00	1.00-3.00					
Página	B123	B124	B127	Web	Web	Web	Web	C67

Cabeça CoroCut® MB inteiriça de metal duro para pré-cortes

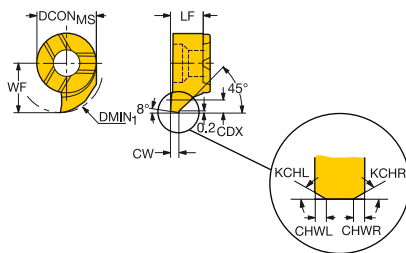

CZC _{MS}	CW	KCHL	KCHR	CHWL	CHWR	CDX	DMIN ₁	Código para pedido	P	M	N	S	O	Dimensões, mm		
									1025	1025	1025	1025	1025	DCON _{MS}	LF	WF
07	1.00	45°	45°	0.04	0.04	0.7	10.0	MB-07GX100-00-10R/L	*	*	*	*	*	7	3.9	5.8

CZC_{MS} para corresponder com CZC_{WS} no adaptador.

R = versão direita, L = versão esquerda

Tolerâncias:		
	CWTOLL	CWTOLU
MB..GX	0.000	0.050



F2



B134



B149



H36



H25



Cabeça CoroCut® MB inteiriça de metal duro para canais

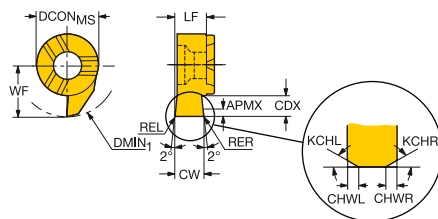

C	ZC _{MS}	CW	REL	RER	KCHL	KCHR	CHWL	CHWR	CDX	DMIN ₁	Código para pedido	P	M	N	S	H	O	Dimensões, mm		
												1025	1025	1025	1025	7015	1025	DCON _{MS}	LF	WF
												*	*	*	*	*	*	*	*	*
	07	1.00			45°	45°	0.04	0.04	1.8	10.0	MB-07G100-00-10L	*	*	*	*	*	*	7	3.9	5.8
	07	1.00			45°	45°	0.04	0.04	1.8	10.0	MB-07G100-00-10R	*	*	*	*	*	*	7	3.9	5.8
	07	1.00			45°	45°	0.04	0.04	2.8	11.0	MB-07G100-00-11L	*	*	*	*	*	*	7	3.9	6.8
	07	1.00			45°	45°	0.04	0.04	2.8	11.0	MB-07G100-00-11R	*	*	*	*	*	*	7	3.9	6.8
	07	1.00			45°	45°	0.04	0.04	3.1	12.0	MB-07G100-00-12L	*	*	*	*	*	*	7	3.9	7.4
	07	1.00			45°	45°	0.04	0.04	3.1	12.0	MB-07G100-00-12R	*	*	*	*	*	*	7	3.9	7.4
	07	1.50			45°	45°	0.04	0.04	1.8	10.0	MB-07G150-00-10L	*	*	*	*	*	*	7	3.9	5.8
	07	1.50			45°	45°	0.04	0.04	1.8	10.0	MB-07G150-00-10R	*	*	*	*	*	*	7	3.9	5.8
	07	1.50			45°	45°	0.04	0.04	2.8	11.0	MB-07G150-00-11L	*	*	*	*	*	*	7	3.9	6.8
	07	1.50			45°	45°	0.04	0.04	2.8	11.0	MB-07G150-00-11R	*	*	*	*	*	*	7	3.9	6.8
	07	1.50			45°	45°	0.04	0.04	3.4	12.0	MB-07G150-00-12L	*	*	*	*	*	*	7	3.9	7.4
	07	1.50			45°	45°	0.04	0.04	3.4	12.0	MB-07G150-00-12R	*	*	*	*	*	*	7	3.9	7.4
	07	2.00			45°	45°	0.04	0.04	1.8	10.0	MB-07G200-00-10L	*	*	*	*	*	*	7	3.9	5.8
	07	2.00			45°	45°	0.04	0.04	1.8	10.0	MB-07G200-00-10R	*	*	*	*	*	*	7	3.9	5.8
	07	2.00			45°	45°	0.04	0.04	2.8	11.0	MB-07G200-00-11L	*	*	*	*	*	*	7	3.9	6.8
	07	2.00			45°	45°	0.04	0.04	2.8	11.0	MB-07G200-00-11R	*	*	*	*	*	*	7	3.9	6.8
	07	2.00			45°	45°	0.04	0.04	3.4	12.0	MB-07G200-00-12L	*	*	*	*	*	*	7	3.9	7.4
	07	2.00			45°	45°	0.04	0.04	3.4	12.0	MB-07G200-00-12R	*	*	*	*	*	*	7	3.9	7.4
	07	2.50			45°	45°	0.04	0.04	1.8	10.0	MB-07G250-00-10L	*	*	*	*	*	*	7	3.9	5.8
	07	2.50			45°	45°	0.04	0.04	1.8	10.0	MB-07G250-00-10R	*	*	*	*	*	*	7	3.9	5.8
	07	2.50			45°	45°	0.04	0.04	2.8	11.0	MB-07G250-00-11L	*	*	*	*	*	*	7	3.9	6.8
	07	2.50			45°	45°	0.04	0.04	2.8	11.0	MB-07G250-00-11R	*	*	*	*	*	*	7	3.9	6.8
	07	3.00			45°	45°	0.04	0.04	1.8	10.0	MB-07G300-00-10L	*	*	*	*	*	*	7	3.9	5.8
	07	3.00			45°	45°	0.04	0.04	1.8	10.0	MB-07G300-00-10R	*	*	*	*	*	*	7	3.9	5.8
	07	3.00			45°	45°	0.04	0.04	2.8	11.0	MB-07G300-00-11L	*	*	*	*	*	*	7	3.9	6.8
	07	3.00			45°	45°	0.04	0.04	2.8	11.0	MB-07G300-00-11R	*	*	*	*	*	*	7	3.9	6.8
	07	3.18			45°	45°	0.04	0.04	1.8	10.0	MB-07G318-00-10L	*	*	*	*	*	*	7	3.9	5.8
	07	3.18			45°	45°	0.04	0.04	1.8	10.0	MB-07G318-00-10R	*	*	*	*	*	*	7	3.9	5.8
	07	3.18			45°	45°	0.04	0.04	2.8	11.0	MB-07G318-00-11L	*	*	*	*	*	*	7	3.9	6.8
	07	3.18			45°	45°	0.04	0.04	2.8	11.0	MB-07G318-00-11R	*	*	*	*	*	*	7	3.9	6.8

ZC_{MS} para corresponder com ZC_{WS} no adaptador.

R = versão direita, L = versão esquerda

Tolerâncias:				
	CWTOLL	CWTOLU	RETOLL	RETOLU
MB..G	0.00	0.05	-0.02	0.02



Cabeça CoroCut® MB inteira de metal duro para canais

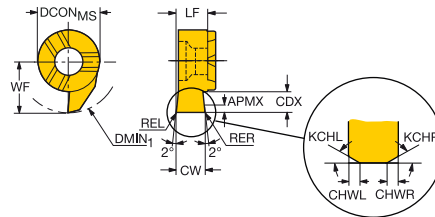

CZC _{MS}	CW	REL	RER	KCHL	KCHR	CHWL	CHWR	CDX	DMIN ₁	Código para pedido	P M N S H O					Dimensões, mm			
											1025	1025	1025	1025	7015	1025	DCON _{MS}	LF	WF
09	1.00			45°	45°	0.04	0.04	4.0	14.0	MB-09G100-00-14L	*	*	*	*	*	*	9	5.2	9.0
09	1.00			45°	45°	0.04	0.04	4.0	14.0	MB-09G100-00-14R	*	*	*	*	*	*	9	5.2	9.0
09	1.50			45°	45°	0.04	0.04	4.0	14.0	MB-09G150-00-14L	*	*	*	*	*	*	9	5.3	9.0
09	1.50			45°	45°	0.04	0.04	4.0	14.0	MB-09G150-00-14R	*	*	*	*	*	*	9	5.3	9.0
09	1.50			45°	45°	0.04	0.04	5.5	16.0	MB-09G150-00-16L	*	*	*	*	*	*	9	5.2	10.5
09	1.50			45°	45°	0.04	0.04	5.5	16.0	MB-09G150-00-16R	*	*	*	*	*	*	9	5.2	10.5
09	1.50			45°	45°	0.04	0.04	6.5	17.0	MB-09G150-00-17L	*	*	*	*	*	*	9	5.2	11.5
09	1.50			45°	45°	0.04	0.04	6.5	17.0	MB-09G150-00-17R	*	*	*	*	*	*	9	5.2	11.5
09	1.50	0.20	0.20					4.0	16.0	MB-09G150-02-16L	*	*	*	*	*	*	9	5.3	9.0
09	1.50	0.20	0.20					4.0	16.0	MB-09G150-02-16R	*	*	*	*	*	*	9	5.3	9.0
09	2.00			45°	45°	0.04	0.04	4.0	14.0	MB-09G200-00-14L	*	*	*	*	*	*	9	5.3	9.0
09	2.00			45°	45°	0.04	0.04	4.0	14.0	MB-09G200-00-14R	*	*	*	*	*	*	9	5.3	9.0
09	2.00			45°	45°	0.04	0.04	5.5	16.0	MB-09G200-00-16L	*	*	*	*	*	*	9	5.2	10.5
09	2.00			45°	45°	0.04	0.04	5.5	16.0	MB-09G200-00-16R	*	*	*	*	*	*	9	5.2	10.5
09	2.00			45°	45°	0.04	0.04	6.5	17.0	MB-09G200-00-17L	*	*	*	*	*	*	9	5.2	11.5
09	2.00			45°	45°	0.04	0.04	6.5	17.0	MB-09G200-00-17R	*	*	*	*	*	*	9	5.2	11.5
09	2.00	0.20	0.20					4.0	14.0	MB-09G200-02-14L	*	*	*	*	*	*	9	5.3	9.0
09	2.00	0.20	0.20					4.0	14.0	MB-09G200-02-14R	*	*	*	*	*	*	9	5.3	9.0
09	2.00	0.20	0.20					5.5	16.0	MB-09G200-02-16L	*	*	*	*	*	*	9	5.2	10.5
09	2.00	0.20	0.20					5.5	16.0	MB-09G200-02-16R	*	*	*	*	*	*	9	5.2	10.5
09	2.50			45°	45°	0.04	0.04	4.0	14.0	MB-09G250-00-14L	*	*	*	*	*	*	9	5.3	9.0
09	2.50			45°	45°	0.04	0.04	4.0	14.0	MB-09G250-00-14R	*	*	*	*	*	*	9	5.3	9.0
09	2.50			45°	45°	0.04	0.04	5.5	16.0	MB-09G250-00-16L	*	*	*	*	*	*	9	5.2	10.5
09	2.50			45°	45°	0.04	0.04	5.5	16.0	MB-09G250-00-16R	*	*	*	*	*	*	9	5.2	10.5
09	2.50			45°	45°	0.04	0.04	6.5	17.0	MB-09G250-00-17L	*	*	*	*	*	*	9	5.2	11.5
09	2.50			45°	45°	0.04	0.04	6.5	17.0	MB-09G250-00-17R	*	*	*	*	*	*	9	5.2	11.5
09	2.50	0.20	0.20					5.5	16.0	MB-09G250-02-16L	*	*	*	*	*	*	9	5.2	10.5
09	2.50	0.20	0.20					5.5	16.0	MB-09G250-02-16R	*	*	*	*	*	*	9	5.2	10.5
09	3.00			45°	45°	0.04	0.04	4.0	14.0	MB-09G300-00-14L	*	*	*	*	*	*	9	5.3	9.0
09	3.00			45°	45°	0.04	0.04	4.0	14.0	MB-09G300-00-14R	*	*	*	*	*	*	9	5.3	9.0
09	3.00			45°	45°	0.04	0.04	5.5	16.0	MB-09G300-00-16L	*	*	*	*	*	*	9	5.2	10.5
09	3.00			45°	45°	0.04	0.04	5.5	16.0	MB-09G300-00-16R	*	*	*	*	*	*	9	5.2	10.5
09	3.00			45°	45°	0.04	0.04	6.5	17.0	MB-09G300-00-17L	*	*	*	*	*	*	9	5.2	11.5
09	3.00			45°	45°	0.04	0.04	6.5	17.0	MB-09G300-00-17R	*	*	*	*	*	*	9	5.2	11.5
09	3.00	0.20	0.20					5.5	16.0	MB-09G300-02-16L	*	*	*	*	*	*	9	5.2	10.5
09	3.00	0.20	0.20					5.5	16.0	MB-09G300-02-16R	*	*	*	*	*	*	9	5.2	10.5
09	3.18			45°	45°	0.04	0.04	4.0	14.0	MB-09G318-00-14L	*	*	*	*	*	*	9	5.3	9.0
09	3.18			45°	45°	0.04	0.04	4.0	14.0	MB-09G318-00-14R	*	*	*	*	*	*	9	5.3	9.0
09	3.18	0.20	0.20					4.0	14.0	MB-09G318-02-14L	*	*	*	*	*	*	9	5.3	9.0
09	3.18	0.20	0.20					4.0	14.0	MB-09G318-02-14R	*	*	*	*	*	*	9	5.3	9.0
11	1.50	0.20	0.20					8.0	20.0	MB-11G150-02-20L	*	*	*	*	*	*	11	5.6	14.0
11	1.50	0.20	0.20					8.0	20.0	MB-11G150-02-20R	*	*	*	*	*	*	11	5.6	14.0
11	2.00	0.20	0.20					8.0	20.0	MB-11G200-02-20L	*	*	*	*	*	*	11	5.6	14.0
11	2.00	0.20	0.20					8.0	20.0	MB-11G200-02-20R	*	*	*	*	*	*	11	5.6	14.0
11	2.50	0.20	0.20					8.0	20.0	MB-11G250-02-20L	*	*	*	*	*	*	11	5.6	14.0
11	2.50	0.20	0.20					8.0	20.0	MB-11G250-02-20R	*	*	*	*	*	*	11	5.6	14.0
11	3.00	0.20	0.20					8.0	20.0	MB-11G300-02-20L	*	*	*	*	*	*	11	5.6	14.0
11	3.00	0.20	0.20					8.0	20.0	MB-11G300-02-20R	*	*	*	*	*	*	11	5.6	14.0
11	3.18	0.20	0.20					8.0	20.0	MB-11G318-02-20L	*	*	*	*	*	*	11	5.6	14.0
11	3.18	0.20	0.20					8.0	20.0	MB-11G318-02-20R	*	*	*	*	*	*	11	5.6	14.0
11	4.00	0.20	0.20					8.0	20.0	MB-11G400-02-20L	*	*	*	*	*	*	11	5.6	14.0
11	4.00	0.20	0.20					8.0	20.0	MB-11G400-02-20R	*	*	*	*	*	*	11	5.6	14.0

CZC_{MS} para corresponder com CZC_{WS} no adaptador.

R = versão direita, L = versão esquerda

Tolerâncias:	CWTOLL	CWTOLU	RETOLL	RETOLU
MB..G	0.00	0.05	-0.02	0.02



F2



B134



B149



H36



H25



A

Cabeça CoroCut® MB inteiriça de metal duro para canais

Para canais circlip

B

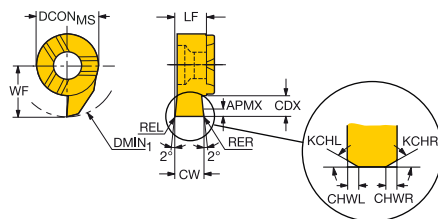

C

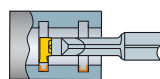

CZC _{MS}	CW	KCHL	KCHR	CHWL	CHWR	CDX	DMIN ₁	Código para pedido	P	M	N	S	O	Dimensões, mm		
									1025	1025	1025	1025	1025	DCON _{MS}	LF	WF
07	0.73	45°	45°	0.04	0.04	1.2	10.0	MB-07G070-00-10R/L	*	*	*	*	*	7	3.8	5.8
07	0.83	45°	45°	0.04	0.04	1.3	10.0	MB-07G080-00-10R/L	*	*	*	*	*	7	3.8	5.8
07	0.93	45°	45°	0.04	0.04	1.5	10.0	MB-07G090-00-10R/L	*	*	*	*	*	7	3.8	5.8
07	1.20	45°	45°	0.04	0.04	1.8	10.0	MB-07G120-00-10R/L	*	*	*	*	*	7	3.9	5.8
07	1.40	45°	45°	0.04	0.04	1.8	10.0	MB-07G140-00-10R/L	*	*	*	*	*	7	3.9	5.8
07	1.70	45°	45°	0.04	0.04	1.8	10.0	MB-07G170-00-10R/L	*	*	*	*	*	7	3.9	5.8
09	0.73	45°	45°	0.04	0.04	1.2	14.0	MB-09G070-00-14R/L	*	*	*	*	*	9	5.2	9.0
09	0.83	45°	45°	0.04	0.04	1.3	14.0	MB-09G080-00-14R/L	*	*	*	*	*	9	5.2	9.0
09	0.93	45°	45°	0.04	0.04	1.5	14.0	MB-09G090-00-14R/L	*	*	*	*	*	9	5.2	9.0
09	1.20	45°	45°	0.04	0.04	4.0	14.0	MB-09G120-00-14R/L	*	*	*	*	*	9	5.3	9.0
09	1.40	45°	45°	0.04	0.04	4.0	14.0	MB-09G140-00-14R/L	*	*	*	*	*	9	5.3	9.0
09	1.70	45°	45°	0.04	0.04	4.0	14.0	MB-09G170-00-14R/L	*	*	*	*	*	9	5.3	9.0

D

CZC_{MS} para corresponder com CZC_{WS} no adaptador.

R = versão direita, L = versão esquerda

Tolerâncias:

	CWTOLL	CWTOLU
MB..G (CIRCLIP)	0.000	0.030

E

F

G

H



F2



B134



B149



H36



H25

Cabeça CoroCut® MB inteiriça de metal duro para canais frontais

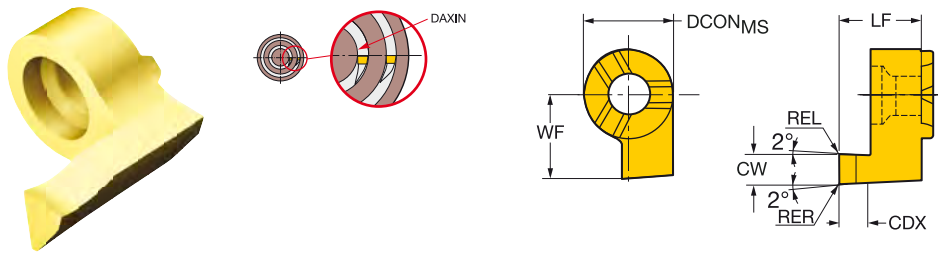

Curvatura A

CZC _{MS}	CW	REL	RER	KCHL	KCHR	CHWL	CDX	DAXIN	OHN	Código para pedido	Dimensões, mm										
											P	M	N	S	DCON _{MS}	LF	WF	CWTOLL	CWTOLU	RETOLL	RETOLU
											1025	1025	1025	1025							
09	1.00			45°	45°	0.40	1.5	12.0		MB-09FA100-00-14R/L	*	*	*	*	9	8.3	9.0	0.000	0.050		
09	1.50	0.20	0.20				2.5	11.0		MB-09FA150-02-14R/L	*	*	*	*	9	8.3	9.0	0.000	0.050	-0.02	0.02
09	2.00	0.20	0.20				5.0	10.0		MB-09FA200-02-14R/L	*	*	*	*	9	10.3	9.0	0.000	0.050	-0.02	0.02
09	2.50	0.20	0.20				5.0	9.0		MB-09FA250-02-14R/L	*	*	*	*	9	10.3	9.0	0.000	0.050	-0.02	0.02
09	3.00	0.20	0.20				5.0	8.0		MB-09FA300-02-14R/L	*	*	*	*	9	10.3	9.0	0.000	0.050	-0.02	0.02
09	3.18	0.20	0.20				5.0	7.6	10.3	MB-09FA318-02-14R/L	*	*	*	*	9	10.3	9.0	0.000	0.050	-0.02	0.02
11	3.00	0.20	0.20				10.0	10.0		MB-11FA300-02-16R/L	*	*	*	*	11	15.8	11.0	0.000	0.050	-0.02	0.02
11	4.00	0.20	0.20				10.0	8.0		MB-11FA400-02-16R/L	*	*	*	*	11	15.8	11.5	0.000	0.050	-0.02	0.02

Curvatura B

CZC _{MS}	CW	REL	RER	KCHL	KCHR	CHWL	CDX	DAXIN	OHN	Código para pedido	Dimensões, mm										
											P	M	N	S	DCON _{MS}	LF	WF	CWTOLL	CWTOLU	RETOLL	RETOLU
											1025	1025	1025	1025							
09	1.00			45°	45°	0.40	1.5	10.0		MB-09FB100-00-14R/L	*	*	*	*	9	8.3	7.0	0.000	0.050		
09	1.50	0.20	0.20				2.5	9.0		MB-09FB150-02-14R/L	*	*	*	*	9	8.3	7.5	0.000	0.050	-0.02	0.02
09	2.00	0.20	0.20				5.0	8.0		MB-09FB200-02-14R/L	*	*	*	*	9	10.3	8.0	0.000	0.050	-0.02	0.02
09	2.50	0.20	0.20				5.0	7.0		MB-09FB250-02-14R/L	*	*	*	*	9	10.3	8.5	0.000	0.050	-0.02	0.02
09	3.00	0.20	0.20				5.0	6.0		MB-09FB300-02-14R/L	*	*	*	*	9	10.3	9.0	0.000	0.050	-0.02	0.02
09	3.18	0.20	0.20				5.0	5.6	10.3	MB-09FB318-02-12R/L	*	*	*	*	9	10.3	9.2	0.000	0.030	0.02	0.02
11	3.00	0.20	0.20				10.0	10.0		MB-11FB300-02-16R/L	*	*	*	*	11	15.8	11.0	0.000	0.050	-0.02	0.02
11	4.00	0.20	0.20				10.0	8.0		MB-11FB400-02-16R/L	*	*	*	*	11	15.8	12.0	0.000	0.050	-0.02	0.02

CZC_{MS} para corresponder com CZC_{WS} no adaptador.

R = versão direita, L = versão esquerda



A

Cabeça CoroCut® MB inteiriça de metal duro para canais frontais

POR

B

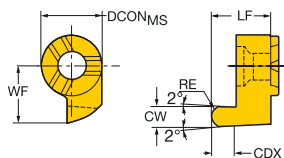
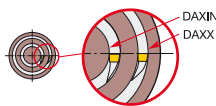

Curvatura A

C

CZC _{MS}	CW	REL	RER	CDX	DAXIN	Código para pedido	P	M	N	S	O	Dimensões, mm		
							1025	1025	1025	1025	1025	DCON _{MS}	LF	WF
09	1.00	0.50	0.50	1.5	12.0	MB-09FAR100-05-14R/L	*	*	*	*	*	9	8.3	9.0
09	1.50	0.75	0.75	2.5	11.0	MB-09FAR150-075-14R/L	*	*	*	*	*	9	8.3	9.0
09	2.00	1.00	1.00	5.0	10.0	MB-09FAR200-10-14R/L	*	*	*	*	*	9	10.3	9.0
09	2.50	1.25	1.25	5.0	9.0	MB-09FAR250-125-14R/L	*	*	*	*	*	9	10.3	9.0
09	3.00	1.50	1.50	5.0	8.0	MB-09FAR300-15-14R/L	*	*	*	*	*	9	10.3	9.0

D

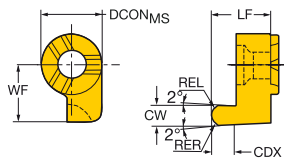
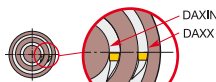

E

Curvatura B

F

CZC _{MS}	CW	REL	RER	CDX	DAXIN	Código para pedido	P	M	N	S	O	Dimensões, mm		
							1025	1025	1025	1025	1025	DCON _{MS}	LF	WF
09	1.00	0.50	0.50	1.5	10.0	MB-09FBR100-05-12R/L	*	*	*	*	*	9	8.3	7.0
09	1.50	0.75	0.75	2.5	9.0	MB-09FBR150-075-14R/L	*	*	*	*	*	9	8.3	7.5
09	2.00	1.00	1.00	5.0	8.0	MB-09FBR200-10-14R/L	*	*	*	*	*	9	10.3	8.0
09	2.50	1.25	1.25	5.0	7.0	MB-09FBR250-125-14R/L	*	*	*	*	*	9	10.3	8.5
09	3.00	1.50	1.50	5.0	6.0	MB-09FBR300-15-14R/L	*	*	*	*	*	9	10.3	9.0

CZC_{MS} para corresponder com CZC_{WS} no adaptador.

R = versão direita, L = versão esquerda

Tolerâncias:

	CWTOLL	CWTOLU	RETOLL	RETOLU
MB..FAR	0.000	0.030	0.00	0.02
MB..FBR	0.000	0.030	0.00	0.02

H



F2



B134



B149



H36

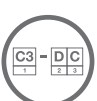

H25



SAND
CORPORATION

Recomendações de velocidade de corte

As recomendações são válidas para uso com refrigeração.

ISO P	No. CMC	Aços	Força de corte específica k_{c1}	Dureza Brinell	<<<< RESISTÊNCIA AO DESGASTE		
					CT525	GC3115	GC4325
					$h_{ex}, mm \approx$ avanço $f_n, mm/r$		
Nº MC	Material	N/mm ²	HB	Velocidade de corte (V_c) m/min			
P1.1.Z.AN	01.1	C = 0.1-0.25%	1500	125	235-170	355-185	340-180
P1.2.Z.AN	01.2	C = 0.25-0.55%	1600	150	220-155	330-140	315-140
P1.3.Z.AN	01.3	C = 0.55-0.80%	1700	170	210-145	300-125	290-120
P2.1.Z.AN	02.1	Baixa-liga ≤5% Não endurecidos	1700	180	205-145	290-135	280-130
P2.5.Z.HT	02.2	Endurecidos e temperados	1850	275	185-120	270-105	265-100
P2.5.Z.HT	02.2	Endurecidos e temperados	2050	350	150-100	220-85	215-80
P3.0.Z.AN	03.11	Alta-liga >5% Recozidos	1950	200	130-100	260-115	255-105
P3.0.Z.HT	03.21	Aços-ferramenta endurecidos	3000	325	80-55	205-75	195-75
P1.5.C.UT	06.1	Fundidos Sem liga	1550	180	150-100	175-75	165-70
P2.6.C.UT	06.2	Baixa-liga (elementos de liga ≤5%)	1600	200	135-85	200-90	190-85
P3.0.C.UT	06.3	Alta-liga (elementos de liga >5%)	2050	225	115-70	160-75	130-95
P3.2.C.AQ	06.33	Aços-manganês, 12-14% Mn	2900	250	75-50	90-50	85-45
ISO M	No. CMC	Aços inoxidáveis	Força de corte específica k_{c1}	Dureza Brinell	<<<< RESISTÊNCIA AO DESGASTE		
Nº MC	Material	N/mm ²	HB	CT525	GC1105	GC1005	
				$h_{ex}, mm \approx$ avanço $f_n, mm/r$			
					Velocidade de corte (V_c) m/min		
P5.0.Z.AN	05.11	Ferríticos/martensíticos Barras/forjados Não endurecidos	1800	200	195-135	235-110	210-100
P5.0.Z.PH	05.12	Endurecidos PH	2850	330	135-95	185-85	170-75
P5.0.Z.HT	05.13	Endurecidos	2350	330	150-100	200-90	180-80
M1.0.Z.AQ	05.21	Austeníticos Barras/forjados	1800	180	190-130	265-125	240-110
M1.0.Z.PH	05.22	Endurecidos PH	2850	330	115-80	185-90	165-80
M2.0.Z.AQ	05.23	Super austeníticos	2250	200	130-90	200-95	180-85
M3.1.Z.AQ	05.51	Austeníticos-ferríticos (Duplex) Barras/forjados Não-soldáveis ≥ 0.05%C	2000	230	115-90	225-105	200-95
M3.2.Z.AQ	05.52	Soldáveis < 0.05%C	2450	260	90-70	185-90	165-80
P5.0.C.UT	15.11	Ferríticos/martensíticos Fundidas	1700	200	165-115	-	-
P5.0.C.HT	15.13	Endurecidos	2150	330	110-75	-	-
M1.0.C.UT	15.21	Austeníticos Fundidas	1700	180	160-110	-	-
	15.22	Endurecidos PH	2450	330	95-65	-	-
M3.1.C.AQ	15.51	Austeníticos-ferríticos (Duplex) Fundidas Não-soldáveis ≥ 0.05%C	1800	230	100-80	-	-
M3.2.C.AQ	15.52	Soldáveis < 0.05%C	2250	260	80-60	-	-
ISO K	No. CMC	Ferros fundidos	Força de corte específica k_{c1}	Dureza Brinell	<<<< RESISTÊNCIA AO DESGASTE		
Nº MC	Material	N/mm ²	HB	GC3115	GC4225	GC1125	
				$h_{ex}, mm \approx$ avanço $f_n, mm/r$			
					Velocidade de corte (V_c) m/min		
K1.1.C.NS	07.1	Maleáveis Ferríticos (cavacos curtos)	790	130	340-170	320-170	255-125
	07.2	Perlíticos (cavacos longos)	900	230	250-115	235-110	170-95
K2.1.C.UT	08.1	Cinzentos Baixa resistência à tensão	890	180	290-140	275-130	210-110
K2.2.C.UT	08.2	Alta resistência à tensão	970	220	250-120	240-115	175-90
K3.1.C.UT	09.1	Ferros nodulares SG Ferríticos	900	160	260-115	250-105	185-95
K3.3.C.UT	09.2	Perlíticos	1350	250	205-100	195-90	150-75
K3.4.C.UT	09.3	Martensíticos	2100	380	145-70	140-70	100-55

TENACIDADE >>>>						
GC1115	GC1125	GC1025	GC1135	GC1145	GC235	
0.05-0.5	0.05-0.5	0.05-0.5	0.05-0.5	0.05-0.5	0.05-0.5	
360-180 325-145 290-130	295-145 265-115 235-105	235-115 210-90 185-85	205-100 180-75 175-70	200-100 185-75 175-70	165-130 150-120 140-105	
290-135 250-115 200-95	235-110 205-95 165-75	185-85 165-75 135-60	175-80 155-70 125-55	180-85 165-70 130-55	140-110 120-85 95-70	
255-115 185-75	205-95 150-65	170-75 120-50	155-70 105-45	160-75 105-45	70-60 45-33	
- - - -	135-65 160-85 120-50 70-40	110-55 130-65 80-45 55-30	105-50 120-60 90-40 50-29	110-50 125-65 85-38 -	100-70 90-55 80-45 100-80	
TENACIDADE >>>>						
GC1115	GC1125	GC1025	GC1135	GC1145	GC235	H13A
0.05-0.5	0.05-0.5	0.05-0.5	0.05-0.5	0.05-0.5	0.05-0.5	0.05-0.5
235-110 185-85 200-90	190-85 150-65 160-70	160-70 120-55 130-55	145-65 110-45 120-50	150-60 110-45 125-50	130-100 90-70 100-75	90-70 60-40 70-50
265-125 185-90 200-95	215-100 150-70 160-75	175-80 120-55 130-60	165-70 105-50 115-55	165-65 110-50 105-50	125-95 75-55 85-65	100-65 50-33 65-45
225-105 185-90	180-85 150-70	145-70 120-55	135-60 110-50	145-60 115-50	125-95 95-70	- -
215-100 -	175-80 145-65	140-65 120-50	130-60 110-45	140-55 115-45	110-85 70-55	75-60 50-38
230-110 150-80	185-90 120-65	150-70 95-50	135-60 90-45	145-60 90-45	105-80 65-50	70-45 45-29
195-95 155-80	155-75 125-65	125-60 105-50	115-55 95-45	120-55 95-45	110-85 85-60	- -
TENACIDADE >>>>						
GC1125	GC1025	H13A	GC1135			
0.05-0.5	0.05-0.5	0.05-0.5	0.05-0.5			
255-125 170-95	205-100 140-75	100-85 70-55	320-170 235-110			
210-110 175-90	170-85 140-70	80-65 80-60	275-130 240-115			
185-95 150-75 100-55	150-80 120-60 85-45	70-55 60-45 40-30	250-105 195-90 140-70			

Recomendações de velocidade de corte

As recomendações são válidas para uso com refrigeração.

ISO N	No. CMC	Material não ferrosos	Força de corte específica k_{c1}	Dureza Brinell	<<<< RESISTÊNCIA AO DESGASTE		
					CD10	GC1005	H10
					$h_{ex}, mm \approx$ avanço $f_n, mm/r$		
Nº MC	No. CMC	Material	N/mm ²	HB	Velocidade de corte (V_c) m/min		
N1.2.Z.UT N1.2.Z.AG	30.11 30.12	Ligas de alumínio Forjadas ou forjadas e trabalhadas a frio, não envelhecidas	400 650	60 100	2100 (2650 - 265) 2100 (2650 - 265)	1900 (2400 - 240) 1900 (2400 - 240)	1800 (2250-225) 1800 (2250-225)
N1.3.C.UT N1.3.C.AG	30.21 30.22	Ligas de alumínio Fundidas, não envelhecidas Fundidos ou fundidos e envelhecidos	600 700	75 90	2100 (2650 - 265) 2100 (2650 - 265)	1900 (2400 - 240) 1900 (2400 - 240)	1800 (2250-225) 1800 (2250-225)
N1.4.C.NS	30.41 30.42	Ligas de alumínio Fundidas, 13-15% Si Fundidas, 16-22% Si	700 700	130 130	1600 (2000 - 200) 800 (1000 - 100)	500 (630 - 65) 350 (440 - 45)	450 (560-55) 300 (375-38)
N3.3.U.UT N3.2.C.UT N3.1.U.UT	33.1 33.2 33.3	Cobre e ligas de cobre Ligas de corte livre, $\geq 1\%$ Pb Latão, bronzes com chumbo, $\leq 1\%$ Pb Bronze e cobre sem chumbo incl. cobre eletrolítico	550 550 1350	110 90 100	600 (750 - 75) 600 (750 - 75) 300 (375 - 38)	500 (630 - 65) 500 (630 - 65) 300 (375 - 38)	500 (630-65) 500 (630-65) 300 (375-38)
ISO S	No. CMC	Super ligas resistentes ao calor	Força de corte específica k_{c1}	Dureza Brinell	<<<< RESISTÊNCIA AO DESGASTE		
					S05F	GC1105	GC1005
					$h_{ex}, mm \approx$ avanço $f_n, mm/r$		
Nº MC	No. CMC	Material	N/mm ²	HB	Velocidade de corte (V_c) m/min		
S1.0.U.AN S1.0.U.AG	20.11 20.12	À base de ferro Recozidas ou tratadas em solução Envelhecidas ou tratadas em solução e envelhecidas	2400 2500	200 280	200-135 165-110	180-120 150-100	160-100 150-100
S2.0.Z.AN S2.0.Z.AG	20.21 20.22	À base de níquel Recozidas ou tratadas em solução Envelhecidas ou tratadas em solução e envelhecidas	2650 2900	250 350	100-60 90-60	90-55 80-50	90-55 80-50
S2.0.C.NS	20.24	Fundidos ou fundidos e envelhecidos	3000	320	80-50	70-45	70-45
S3.0.Z.AN S3.0.Z.AG S3.0.C.NS	20.31 20.32 20.33	Ligas à base de cobalto Recozidas ou tratadas em solução Tratadas em solução e envelhecidas Fundidos ou fundidos e envelhecidos	2700 3000 3100	200 300 320	100-65 90-55 80-50	90-60 80-50 70-45	90-60 80-50 70-45
S4.1.Z.UT S4.2.Z.AN S4.3.Z.AG	23.1 23.21 23.22	Ligas de titânio Comercial puro (99.5% Ti) α , ligas próximo α e $\alpha + \beta$, recozidas ligas $\alpha + \beta$ em condições envelhecidas, ligas β recozidas ou envelhecidas	1300 1400 1400	Rm ¹⁾ 400 950 1050	- - -	- - -	- - -
ISO H	No. CMC	Material	Força de corte específica k_{c1}	Dureza Brinell	<<<< RESISTÊNCIA AO DESGASTE		
					CB20	CC670	CB7015
					$h_{ex}, mm \approx$ avanço $f_n, mm/r$		
Nº MC	No. CMC	Materiais Endurecidos	N/mm ²	HB	Velocidade de corte (V_c) m/min		
H1.3.Z.HA	04.1	Aços extra-duros Endurecidos e temperados	4300	60 HRC	125-120	110-100	145-135
H2.0.C.UT	10.1	Coquilhados Fundidos ou fundidos e envelhecidos	2250	400	200-195	110-100	-

1) Rm = Limite de resistência à tração medido em MPa.

A

POF

TENACIDADE >>>>							
GC1125	GC1025	H13A					
0.05-0.8	0.05-0.8	0.05-0.8					
1500 (1900 - 190) 1500 (1900 - 190)	1500 (1900 - 190) 1500 (1900 - 190)	1500 (1900 - 190) 1500 (1900 - 190)					
1500 (1900 - 190) 1500 (1900 - 190)	1500 (1900 - 190) 1500 (1900 - 190)	1500 (1900 - 190) 1500 (1900 - 190)					
400 (500 - 50) 250 (315 - 31)	400 (500 - 50) 250 (315 - 31)	400 (500 - 50) 250 (315 - 31)					
350 (440 - 45) 400 (500 - 50) 250 (315 - 31)	350 (440 - 45) 400 (500 - 50) 250 (315 - 31)	350 (440 - 45) 400 (500 - 50) 250 (315 - 31)					

B

C

TENACIDADE >>>>									
H10	GC1115	GC1125	GC1025	H13A	GC1135	GC1145	GC235	CC670	CB7015
0.05-0.3	0.05-0.3	0.05-0.3	0.05-0.3	0.05-0.3	0.05-0.3	0.05-0.3	0.05-0.3	0.05-0.3	0.05-0.3
-	100-55	80-45	60-35	50-37	50-29	45-34	50-37	-	-
-	70-40	55-33	45-28	40-26	40-26	45-30	40-26	-	-
-	65-40	50-32	45-28	30-23	40-26	29-23	30-23	600-320	400-300
-	60-32	45-26	40-22	20-13	35-21	19-13	20-13	500-250	350-250
-	45-23	35-18	30-16	20-13	25-10	20-13	20-13	250-120	200-125
-	70-50	55-38	50-33	35-27	45-28	34-23	35-27	410-220	250-150
-	60-32	45-26	40-22	23-15	35-17	23-12	23-15	350-210	250-150
-	45-23	35-18	30-16	20-13	25-14	19-13	20-13	320-150	200-125
190-150 80-60 70-55	310-140 100-55 95-45	220-100 80-45 75-37	190-95 65-37 60-32	175-145 70-60 65-55	170-80 65-35 60-30	- - -	- - -	- - -	- - -

D

E

TENACIDADE >>>>									

F

G

H

Recomendações de dados de corte para o CoroCut® MB

Torneamento

Pastilha tamanho 07

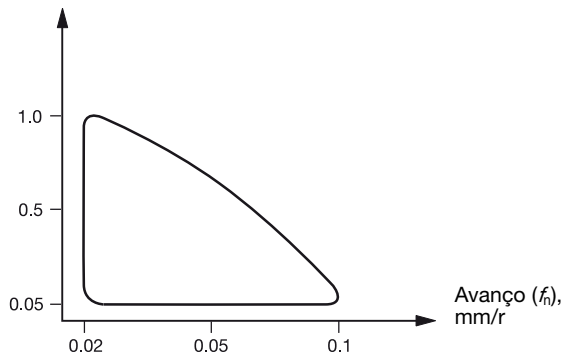
Profundidade de corte (a_p), mm

Canais e canais frontais

Largura da pastilha (CW), mm

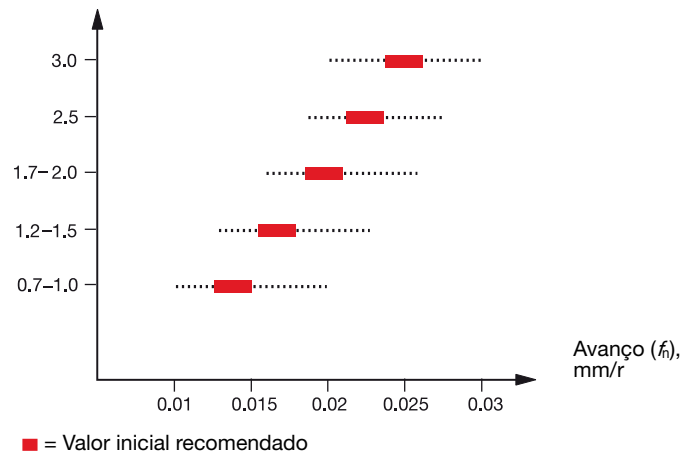

Rosqueamento, (Recomendações de penetração)

Rosca	Pastilha	a_p mm	nap
Perfil V 60°	MB-07TH050VM-10R/L	0.33	4
	MB-07TH100VM-10R/L	0.64	5
	MB-07TH150VM-10R/L	0.89	6
	MB-07TH200VM-10R/L	1.19	8
	MB-07TH250VM-10R/L	1.50	10
Métrica 60°	MB-07TH050MM-10R/L	0.33	4
	MB-07TH100MM-10R/L	0.64	5
	MB-07TH150MM-10R/L	0.89	6
	MB-07TH175MM-10R/L	1.07	8
	MB-07TH200MM-10R/L	1.19	8
	MB-07TH250MM-10R/L	1.50	10
UN 60°	MB-07TH320UN-10R/L	0.48	4
	MB-07TH280UN-10R/L	0.58	5
	MB-07TH240UN-10R/L	0.66	5
	MB-07TH200UN-10R/L	0.79	6
	MB-07TH180UN-10R/L	0.86	6
	MB-07TH160UN-10R/L	0.94	7
	MB-07TH140UN-10R/L	1.09	8
Withworth 55°	MB-07TH190WH-10R/L	0.91	6
	MB-07TH140WH-10R/L	1.21	8
	MB-07TH110WH-10R/L	1.54	9
NPT 60°	MB-07TH180NT-10R/L	1.11	8
	MB-07TH140NT-10R/L	1.42	10

Rosca	Pastilha	a_p mm	nap
ACME 29°	MB-07TH160AC-11R	0.96	6
	MB-07TH140AC-11R	1.09	7
	MB-07TH120AC-11R	1.24	8
	MB-07TH100AC-11R	1.60	10
	MB-07TH080AC-11R	1.90	12
	STUB-ACME 29°	MB-07TH160SA-10R	0.66
MB-07TH140SA-10R		0.74	5
MB-07TH120SA-10R		0.81	6
MB-07TH100SA-10R		1.09	7
MB-07TH080SA-10R		1.27	8

 a_p = profundidade total da rosca nap = números de passes

Recomendações de velocidade de corte

Velocidade de corte (V_c) m/min

Classe 1025	P	M	N	S
	60-200	60-180	90-400	20-50
Classe CB7015	H			
	60-200			

Recomendações de dados de corte para o CoroCut® XS

Pastilhas para torneamento

Tamanho da pastilha	Dimensões, mm		Área de aplicação			
			Torneamento geral/Mandrillamento reverso			
			Profundidade de corte recomendada		Avanço de corte recomendado	
d_{m_m}	WB	RE	a_p mm	mín. - máx.	f_r mm/r	mín. - máx.
04	0.18	-	0.05	(0.01 - 0.08)	0.007	(0.050 - 0.015)
04	0.28	-	0.06	(0.01 - 0.10)	0.010	(0.050 - 0.014)
04	0.38	-	0.08	(0.01 - 0.15)	0.012	(0.008 - 0.017)
04	0.46	-	0.09	(0.01 - 0.20)	0.015	(0.010 - 0.020)
04	0.56	-	0.12	(0.01 - 0.22)	0.018	(0.010 - 0.025)
04	0.63	-	0.15	(0.01 - 0.25)	0.020	(0.012 - 0.025)
04	0.66	0.05	0.15	(0.05 - 0.30)	0.020	(0.012 - 0.030)
04	0.66	0.10	0.15	(0.09 - 0.30)	0.020	(0.015 - 0.080)
04	0.74	-	0.15	(0.01 - 0.25)	0.020	(0.012 - 0.025)
04	1.04	0.05	0.18	(0.05 - 0.30)	0.020	(0.012 - 0.030)
04	1.04	0.10	0.18	(0.01 - 0.30)	0.020	(0.015 - 0.080)
04	1.55	0.05	0.20	(0.05 - 0.40)	0.020	(0.012 - 0.030)
04	1.55	0.10	0.20	(0.09 - 0.40)	0.020	(0.015 - 0.080)
04	2.06	0.05	0.25	(0.05 - 0.51)	0.020	(0.012 - 0.030)
04	2.06	0.15	0.25	(0.15 - 0.51)	0.025	(0.015 - 0.050)
04	2.54	0.05	0.30	(0.05 - 0.51)	0.020	(0.015 - 0.030)
04	2.06/2.59	0.15	0.30	(0.15 - 0.51)	0.025	(0.015 - 0.050)
04	2.95	0.15	0.30	(0.15 - 0.51)	0.025	(0.015 - 0.050)
04	3.45	0.05	0.30	(0.05 - 0.51)	0.020	(0.015 - 0.030)
04	3.45	0.15	0.30	(0.15 - 0.51)	0.025	(0.015 - 0.050)
05	3.76	0.15	0.35	(0.15 - 0.60)	0.040	(0.020 - 0.060)
05	3.75/3.81	0.20	0.35	(0.20 - 0.60)	0.040	(0.020 - 0.060)
05	4.19	0.20	0.35	(0.20 - 0.60)	0.040	(0.020 - 0.070)
05	4.24	0.05	0.25	(0.05 - 0.60)	0.030	(0.020 - 0.040)
05	4.24	0.20	0.35	(0.20 - 0.60)	0.040	(0.020 - 0.070)
06	3.96/3.99	0.15	0.35	(0.15 - 0.60)	0.045	(0.020 - 0.070)
06	3.96	0.20	0.35	(0.20 - 0.60)	0.045	(0.020 - 0.070)
06	5.26	0.20	0.40	(0.20 - 0.70)	0.045	(0.020 - 0.080)
07	4.29	0.20	0.35	(0.20 - 0.60)	0.040	(0.020 - 0.070)
07	6.25	0.20	0.50	(0.20 - 0.80)	0.050	(0.030 - 0.080)

Quando usar a classe de CBN CB7015, reduza o avanço e a profundidade de corte em 50%, comparada às classes de metal duro.

Canais e canais frontais

Largura da pastilha (W1), mm

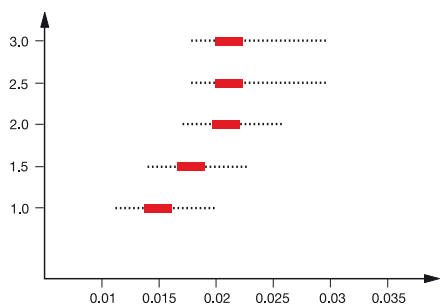

Avanço (f_r), mm/r

■ = Valor inicial recomendado

Rosqueamento, (Recomendações de penetração)

Rosca	Passo		
	mm	a_p mm	nap
Métrica 60° (MM)	0.50	0.26	7
	0.70	0.38	8
	0.75	0.40	8
	0.80	0.43	8
	1.00	0.55	11
	1.25	0.68	11
	1.50	0.81	13
	1.75	0.95	14
ISO Trapezoidal 30°	2.00	1.08	18
	1.50	0.86	6
	2.00	1.17	8
	3.00	1.70	12

a_p = profundidade total da rosca

nap = número de passadas

Recomendações de velocidade de corte

Velocidade de corte (V_c) m/min

Classe 1025	P	M	N	S
	60-200	60-180	90-400	20-50
Classe CB7015	H			
	60-200			

Recomendações de dados de corte para o CoroCut® XS

Corte

Largura da pastilha (CW), mm

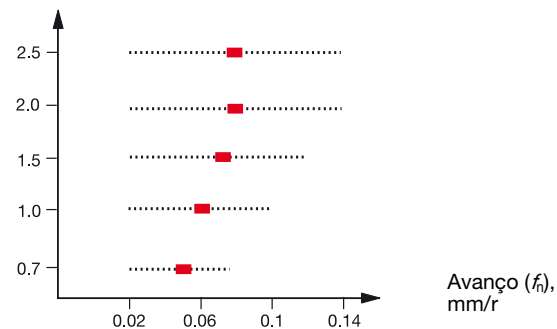

■ = Valor inicial recomendado

Canais

Largura da pastilha (CW), mm

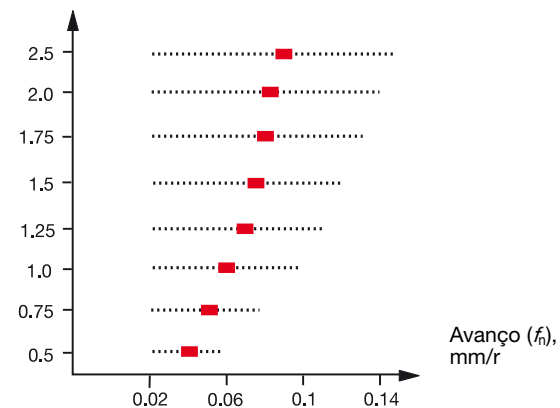

Torneamento

Profundidade de corte (a_p), mm

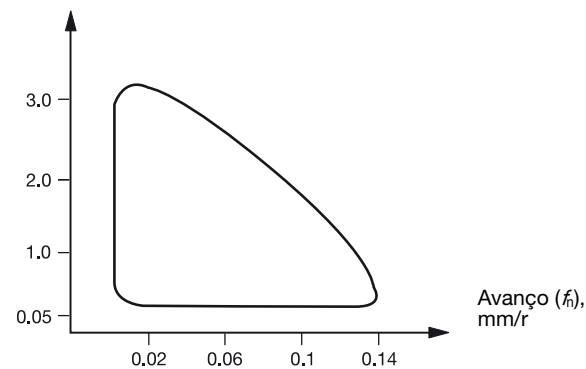

Torneamento reverso

Profundidade de corte (a_p), mm

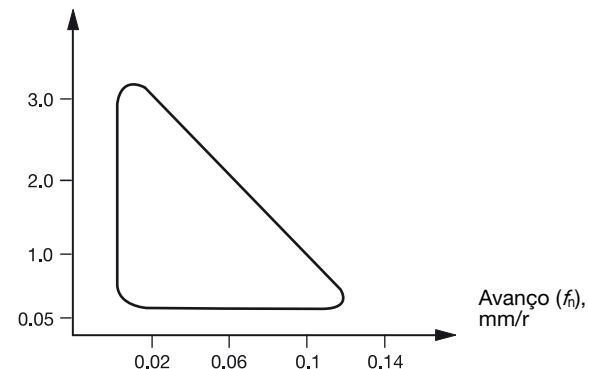

Rosqueamento, (Recomendações de penetração)

Métrica 60°

Passo, mm	a _p mm	nap
0.20	0.12	4
0.25	0.15	4
0.30	0.18	4
0.35	0.20	4
0.40	0.25	4
0.45	0.28	4
0.50	0.28	4
0.75	0.46	4
1.00	0.61	5
1.25	0.74	6
1.50	0.89	6
1.75	1.07	8
2.00	1.22	8

Pode ser usada para roscas tipos:
 - ISO métrica 60°
 - UN 60°
 - NPT

a_p = profundidade total da rosca
 nap = números de passes

UN 60°

Passo, t.p.i.	a _p mm	nap
72	0.22	4
64	0.25	4
56	0.28	4
48	0.33	4
44	0.36	4
40	0.40	4
36	0.43	4
32	0.49	5
28	0.56	5
24	0.65	5
20	0.80	6
18	0.86	6
16	0.97	7
14	1.12	8
13	1.19	8
12	1.30	9

Recomendações de velocidade de corte

Velocidade de corte (V_c) m/min

Classe 1025/1105

P 60-200
 M 60-180
 N 90-400
 S 20-50

Recomendações de dados de corte para o CoroCut® QF

Canais frontais



-RM

Avanço na usinagem de canais
Largura da pastilha (CW), mm, pol.

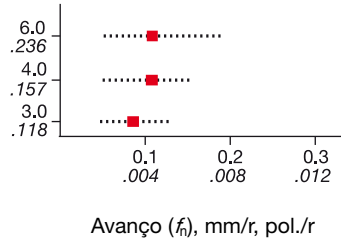

Avanço no torneamento
Profundidade de corte (a_p), mm, polegadas

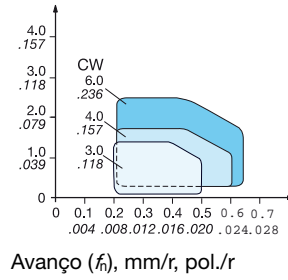

Excelente para perfilamento em todos os materiais

Excepcional controle de cavacos mesmo com baixos avanços e profundidades de corte pequenas.
Bom acabamento superficial.

B



-GF

Avanço na usinagem de canais
Largura da pastilha (CW), mm, pol.

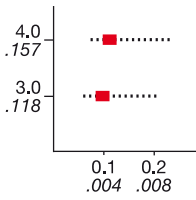

Avanço (f_n), mm/r, pol./r

Para canais de precisão

Precisão e repetibilidade boas devido às tolerâncias estreitas das pastilhas.
Baixas forças de corte e bom acabamento superficial devido à aresta de corte viva.

C

D



-TF

Avanço na usinagem de canais
Largura da pastilha (CW), mm, pol.

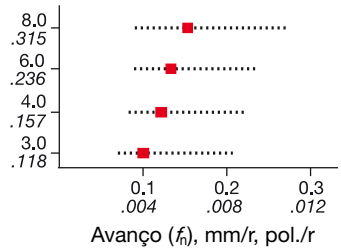

Avanço (f_n), mm/r, pol./r

Avanço no torneamento
Profundidade de corte (a_p), mm, polegadas

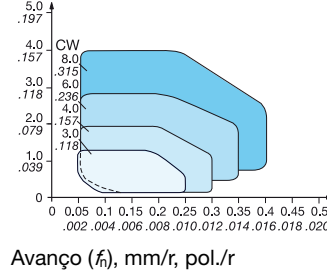

Avanço (f_n), mm/r, pol./r

Geometria de primeira escolha para usinagem de canais frontais

Nossa geometria mais universal para canais frontais em todos os materiais. A geometria positiva propicia baixas forças de corte e bom controle de cavacos.
Bom acabamento superficial graças ao desenho Wiper.
Gera canais de fundo plano.

E

Recomendações de dados de corte para o CoroCut® 1-2

Perfilamento



-RO

Avanço no torneamento
Profundidade de corte (a_p), mm, polegadas

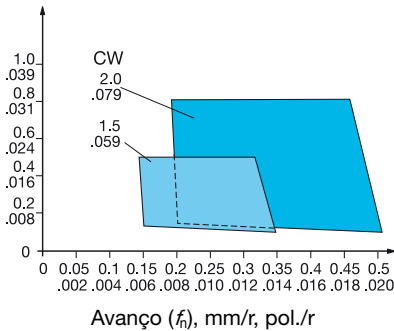

Avanço (f_n), mm/r, pol./r

Excelente para perfilamento em aços inoxidáveis, HRSA e outros materiais pastosos

HRSA e outros materiais pastosos. Excepcional controle de cavacos com baixos avanços e profundidades de corte pequenas.
Bom acabamento superficial. Arestas de corte vivas.
Disponível como pastilhas CoroCut 2-arestas.

G

H

■ = Valor inicial recomendado

Recomendações de dados de corte para o CoroCut® 1-2

Cortes

B

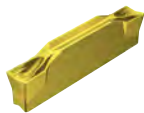

123-CF



Escolha de baixo avanço

Avanço radial

Largura da pastilha (CW), mm

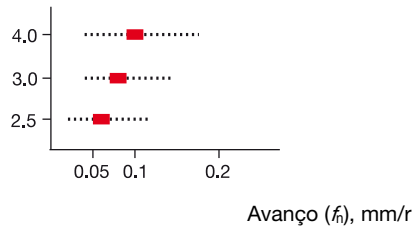

Geometria positiva para baixo avanço

Primeira escolha para peças de paredes finas e diâmetros pequenos. Os raios de canto pequenos e a geometria positiva reduzem saliências (pip) e rebarbas em peças de aço inoxidável e materiais pastosos. Cantos Wiper para melhor acabamento superficial.

C

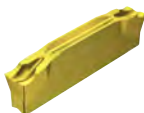

123-CM

Escolha de médio avanço

Avanço radial

Largura da pastilha (CW), mm

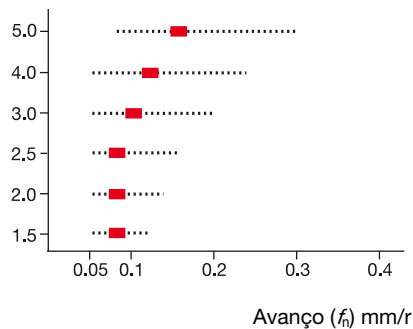

Primeira escolha, geometria universal

Primeira escolha para cortes em direção ao centro em boas condições na maioria dos materiais e aplicações com intermitência leve como cortes de barras hexagonais.

D



123-CR

Escolha para altos avanços

Avanço radial

Largura da pastilha (CW), mm

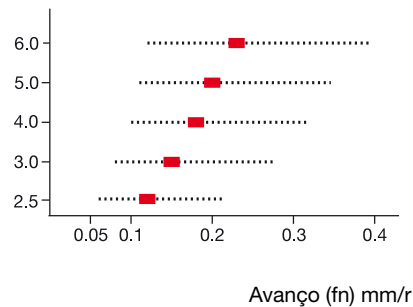

Usinagem em desbaste

Arestas de corte robustas reduzem o risco de quebra da aresta. Apropriada para corte de barras e cortes interrompidos. Para aços e ferros fundidos, mas também adequada para aços inoxidáveis quando forem necessárias arestas mais robustas. Disponível como pastilhas CoroCut 1 e 2-arestas.

F

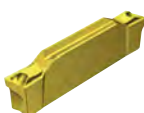

123-CS

Baixo avanço

Avanço radial

Largura da pastilha (CW), mm

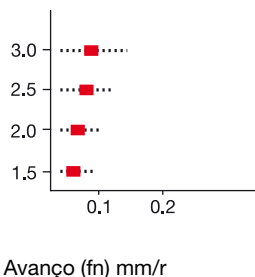

Usinagem sem rebarbas e sem "pips" (saliências)

Solução ideal para minimizar "pips" e rebarbas em peças, graças à aresta de corte viva e ângulos frontais de 10° e 15°. Recomendada para peças pequenas. Apropriada para aços de corte livre. Disponível como pastilhas CoroCut 2-arestas.

G

■ = Valor inicial recomendado

Para recomendações de velocidade de corte, veja página B130

H

Recomendações de dados de corte para o CoroCut® 1-2

Canais

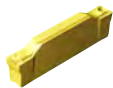

123-GF

Escolha de baixo avanço

Avanço radial
Largura da pastilha (CW), mm

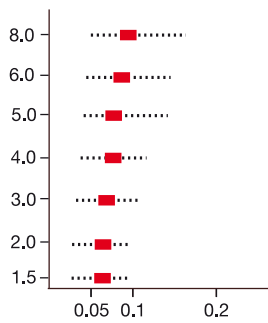

Avanço (f_r), mm/r

Avanço axial
Profundidade de corte (a_p), mm

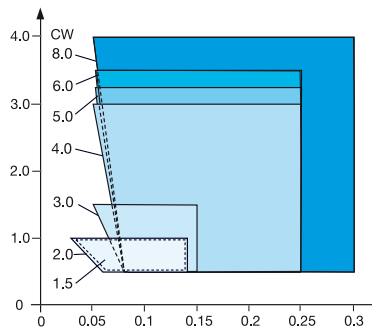

Avanço (f_a), mm/r

Para canais de precisão

Precisão e repetibilidade boas devido às tolerâncias estreitas das pastilhas. Baixas forças de corte e bom acabamento superficial devido à aresta de corte viva. Grande número de diferentes larguras. Desenhada para torneamento lateral. Disponível como pastilhas CoroCut 2-arestas. Pode ser solicitado como Tailor Made com larguras de pastilha e raios de canto diferentes.



123-GM



Escolha de médio avanço

Avanço radial
Largura da pastilha (CW), mm

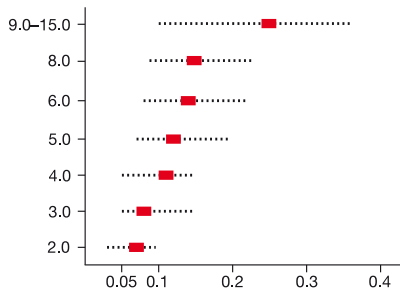

Avanço (f_r), mm/r

Usinagem de canais em todos os materiais

Controle de cavacos excepcional. Largura dos cavacos reduzida proporcionando boas superfícies.

Tamanho do assento M
CW, mm 9-11



123-GR

Avanço radial
Largura da pastilha (CW), mm

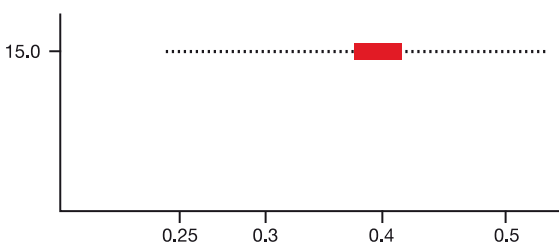

Avanço (f_r), mm/r

Desbaste de canais, aresta de corte robusta para condições difíceis como usinagem de canais em cascas fundidas. Boa para alargar canais.

■ = Valor inicial recomendado

Para recomendações de velocidade de corte, veja página B130

Recomendações de dados de corte para o CoroCut® 1-2

Canais

B



123-GS

Avanço radial
Largura da pastilha (CW), mm

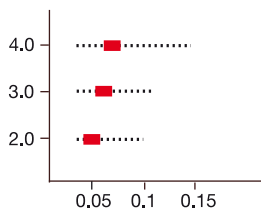

Avanço axial
Profundidade de corte (a_p), mm

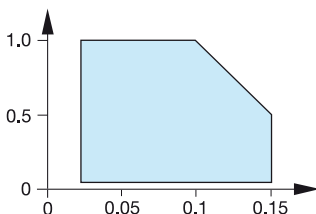

Geometria de uso geral para usinagem de canais com baixo avanço na maioria dos materiais.

Retificada na periferia com aresta de corte viva.

C

Escolha de baixo avanço



123-S

Avanço radial
Largura da pastilha (CW), mm

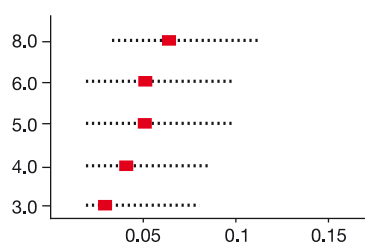

Avanço axial
Profundidade de corte (a_p), mm

Profundidade de corte (a_p), mm

Alternativa para usinagem de acabamento de canais em materiais endurecidos e superligas resistentes ao calor

Mantém as tolerâncias estreitas e oferece um excelente acabamento das peças.

Disponível como pastilhas CoroCut 1-aresta.

D

Ponta de nitreto cúbico de boro

Perfilamento

E



123-RM

Avanço radial
Largura da pastilha (CW), mm

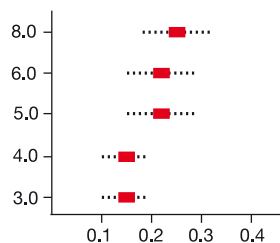

Avanço axial
Profundidade de corte (a_p), mm

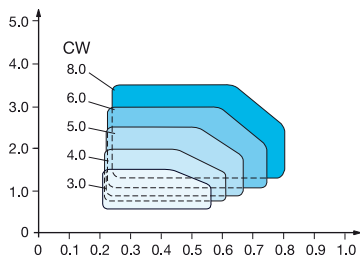

Excelente para perfilamento em todos os materiais

Excepcional controle de cavacos mesmo com baixos avanços e profundidades de corte pequenas. Bom acabamento superficial.

Disponível como pastilhas CoroCut 1 e 2-arestas.

F

Escolha de médio avanço



123-RO

Avanço radial
Largura da pastilha (CW), mm

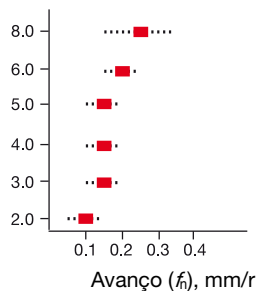

Avanço axial
Profundidade de corte (a_p), mm

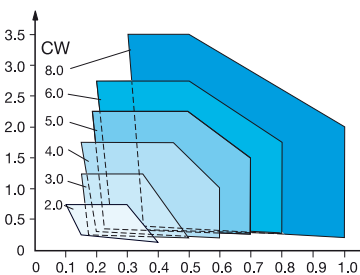

Excelente para perfilamento em aços inoxidáveis, HRSA e outros materiais pastosos

HRSA e outros materiais pastosos. Excelente controle de cavacos com avanços reduzidos e pequenas profundidades de corte.

Bom acabamento superficial. Arestas de corte vivas.

Disponível como pastilhas CoroCut 2-arestas.

H

Para recomendações de velocidade de corte, veja página B130

■ = Valor inicial recomendado

Recomendações de dados de corte para o CoroCut® 1-2

Perfilamento

Geometria de uso geral para perfilamento com cavacos de espessura pequena na maioria dos materiais. Retificada na periferia com aresta de corte viva.

B



123-RS

Avanço radial

Largura da pastilha (CW), mm

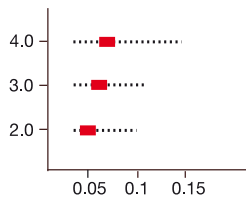

Avanço (f_n) mm/r

Avanço axial

Profundidade de corte (a_p) mm

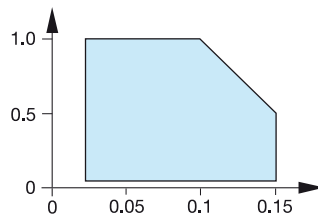

Avanço (f_a) mm/r

Alternativa para perfilamento de acabamento de materiais endurecidos.

Proporciona produtividade e acabamento superficial excelentes. Disponível como pastilhas CoroCut 1-aresta.

C



123-RE

Avanço radial

Largura da pastilha (CW), mm

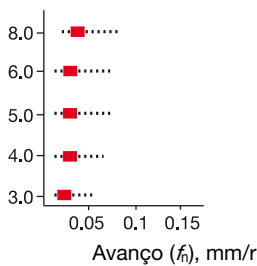

Avanço (f_n), mm/r

Avanço axial

Profundidade de corte (a_p), mm

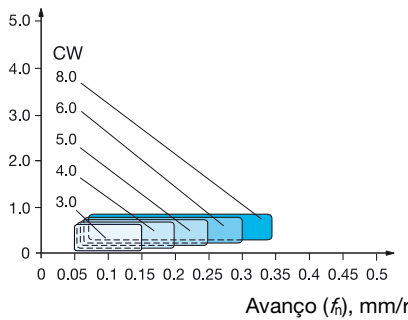

Avanço (f_a), mm/r

Alternativa para perfilamento de acabamento em materiais não-ferrosos.

Proporciona produtividade e acabamento superficial excelentes. Para uso sob condições favoráveis. Disponível como pastilhas CoroCut 1-aresta.

D



123-RS

Avanço radial

Largura da pastilha (CW), mm

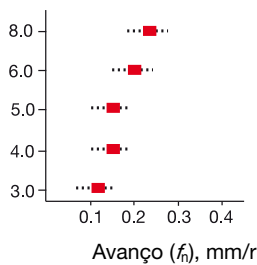

Avanço (f_n), mm/r

Avanço axial

Profundidade de corte (a_p), mm

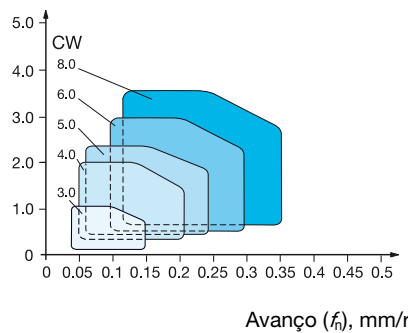

Avanço (f_a), mm/r

Primeira escolha para perfilamento em materiais não-ferrosos.

Bom fluxo de cavacos proporcionando bom acabamento superficial. Aresta de corte viva. Disponível como pastilhas CoroCut 2-arestas.

E

Perfilamento de alumínio



123-AM

Avanço radial

Largura da pastilha (CW), mm

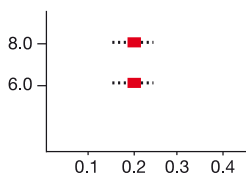

Avanço (f_n), mm/r

Avanço axial

Profundidade de corte (a_p), mm

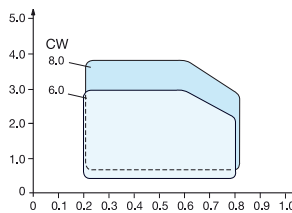

Avanço (f_a), mm/r

■ = Valor inicial recomendado

Para recomendações de velocidade de corte, veja página B130

F

G

H

Recomendações de dados de corte para o CoroCut® 1-2

Torneamento e torneamento em mergulho

B



123-TF

Escolha de baixo avanço

Avanço radial

Largura da pastilha (CW), mm

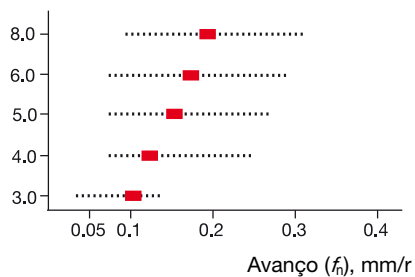

Avanço axial

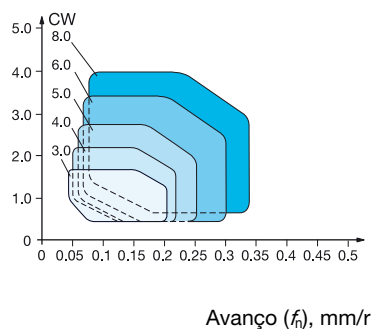
Profundidade de corte (a_p), mm

Adequada para todas as operações de torneamento em aços inoxidáveis

A geometria positiva elimina o risco de arestas postiças. Bom controle de cavacos e bom acabamento superficial. Desenho Wiper na lateral. Disponível como pastilhas CoroCut 1 e 2-arestas. Primeira escolha para canais frontais.

C

D

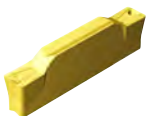

123-TM

Escolha de médio avanço

Avanço radial

Largura da pastilha (CW), mm

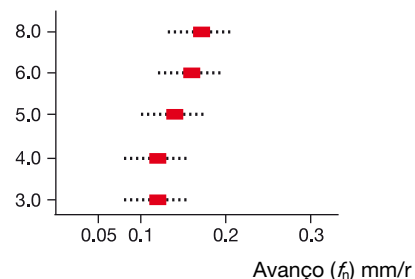

Avanço axial

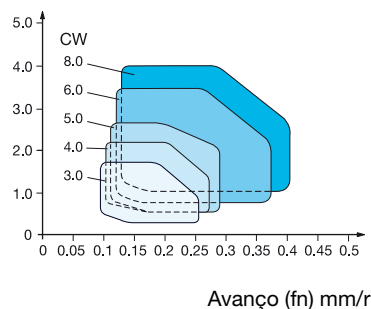
Profundidade de corte (a_p), mm

Operações de torneamento geral

A geometria positiva elimina o risco de arestas postiças. Disponível como pastilhas CoroCut 2-arestas.

E

■ = Valor inicial recomendado

Para recomendações de velocidade de corte, veja página B130

F

G

H

Recomendações de dados de corte para o CoroCut® 3

Cortes rasos



123-CM

Avanço radial

Largura da pastilha (CW), mm

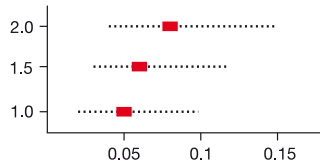

Avanço (f_r), mm/r

Primeira escolha para cortes rasos

Primeira escolha para a maioria dos materiais

Aresta viva, geometria quebra-cavacos

Deve ser usada em velocidades de corte normais: 100 – 250 m/min

B

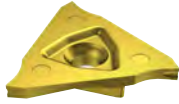

123-CS

Avanço radial

Largura da pastilha (CW), mm

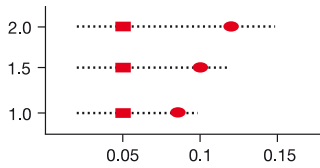

Avanço (f_r), mm/r

Primeira escolha para cortes rasos com baixas velocidades

Para materiais pastosos e materiais de rolamentos de esfera

Aresta extremamente viva com um formador de cavacos aberto

Deve ser usada para materiais não ferrosos com velocidades de corte normais 100 – 250 m/min

Pastilhas versão direita (R - right) ou esquerda (L - left) para uso na usinagem sem "pips" e sem rebarbas

C

Canais



123-GS

Avanço radial

Largura da pastilha (W1), mm

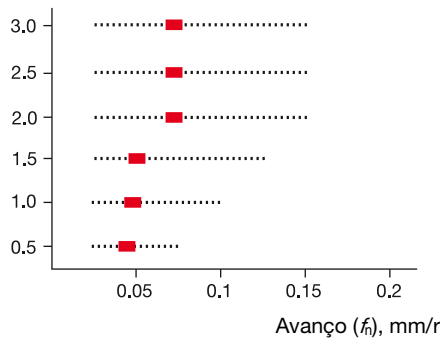

Avanço axial

Profundidade de corte (a_p), mm

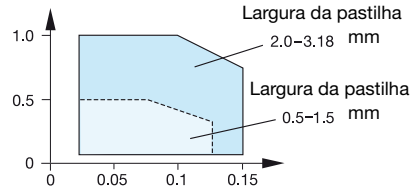

Avanço (f_r), mm/r

D

E

Perfilamento



123-RS

Avanço radial

Largura da pastilha (W1), mm

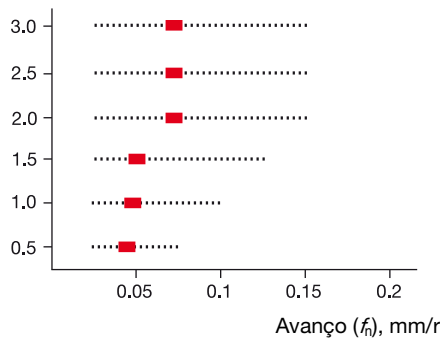

Avanço axial

Profundidade de corte (a_p), mm

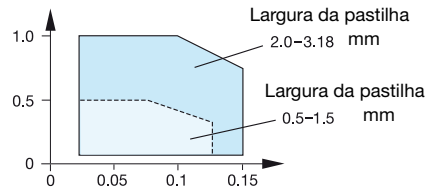

Avanço (f_r), mm/r

F

G

■ = Valor inicial recomendado com velocidades normais

● = Valor inicial recomendado com velocidades baixas

Para recomendações de velocidade de corte, veja página B130

H

Recomendações de dados de corte para o CoroCut® QD

QD-N..-CF

Avanço radial

Largura de corte (CW), mm

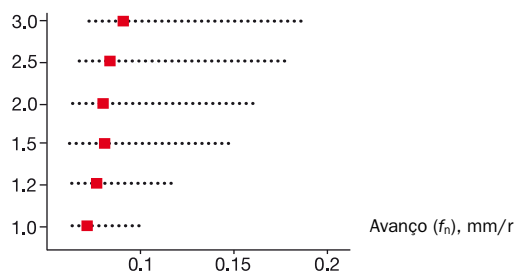
TECNOLOGIA
Wiper**Geometria positiva para baixo avanço**

Primeira escolha para peças de paredes finas e diâmetros pequenos.

Os raios de canto pequenos e a geometria positiva reduzem saliências (pip) e rebarbas em peças de aço inoxidável e materiais pastosos. Cantos Wiper para melhor acabamento superficial.

QD-N..-CM

Avanço radial

Largura de corte (CW), mm

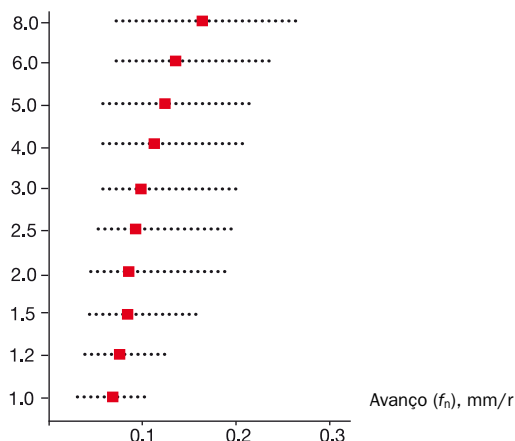
**Primeira escolha, geometria universal**

Primeira escolha para cortes em direção ao centro em boas condições na maioria dos materiais e aplicações com intermitência leve como cortes de barras hexagonais.

QD-R/L..-CM

Avanço radial

Largura de corte (CW), mm

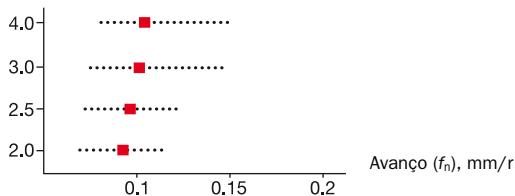
**Geometria universal**

Para reduzir as saliências (pip) e rebarbas em cortes com boas condições na maioria dos materiais e aplicações com intermitência leve como cortes de barras hexagonais.

QD-N..-CR

Avanço radial

Largura de corte (CW), mm

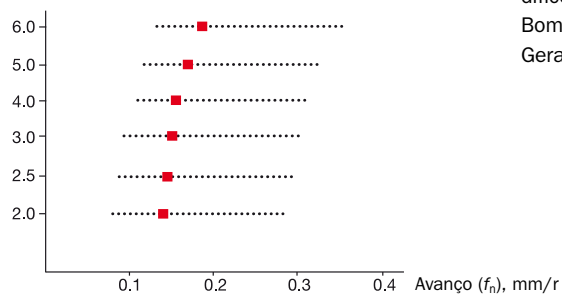
**Geometria robusta, aresta de corte negativa**

Primeira escolha para cortes em direção ao centro em condições difíceis e aplicações com intermitência severa.

Bom controle de cavacos com altos avanços.

Gera canais de fundo plano.

Recomendações de dados de corte para o CoroCut® QD

QD-N..-CL

Avanço radial
Largura de corte (CW), mm

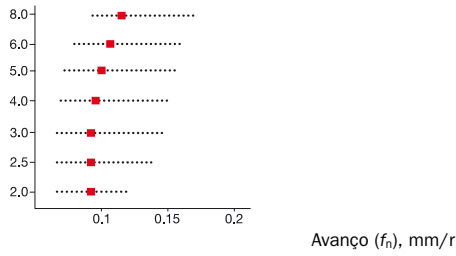

Geometria agressiva para materiais com cavacos longos

Boa quebra de cavacos em aço baixo-carbono, aços para rolamento e outros materiais pastosos
Avanços baixos a médios.

B

QD-N..-CO

Avanço radial
Largura de corte (CW), mm

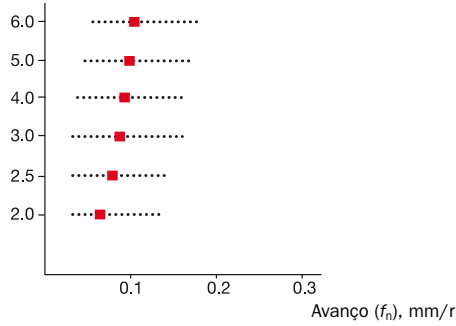

Geometria otimizadora – aresta de corte viva, afiação frontal

Primeira escolha para materiais HRSA (ISO S), aços inoxidáveis duplex e metais não ferrosos.
Baixas forças de corte reduzem as arestas postiças e minimizam o risco de vibrações.

C

QD-R/L..-CO

Avanço radial
Largura de corte (CW), mm

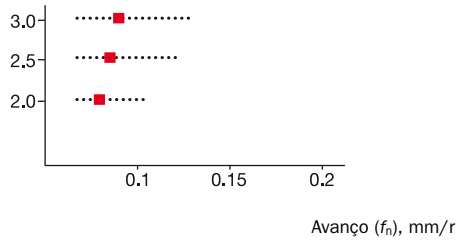

Geometria otimizadora – aresta de corte viva, afiação frontal

Para reduzir as saliências (pip) e rebarbas em cortes com boas condições na maioria dos materiais e aplicações com intermitência leve como cortes de barras hexagonais.
Baixas forças de corte reduzem as arestas postiças e minimizam o risco de vibrações.

D

QD-N..-TF

Avanço radial
Largura de corte (CW), mm

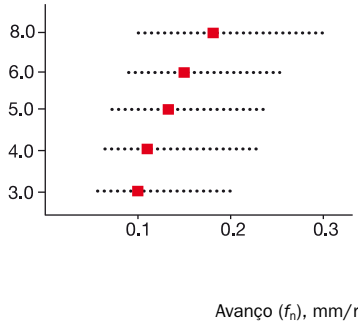

Avanço axial
Profundidade de corte (a_p), mm

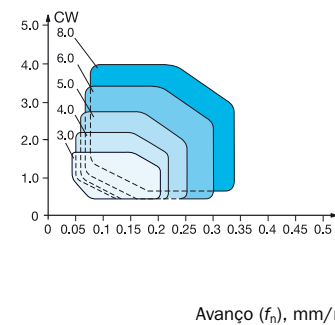

Geometria de primeira escolha para torneamento de canais mais amplos

Nossa geometria mais universal, para torneamento de canais em todos os materiais.

A geometria positiva propicia baixas forças de corte e bom controle de cavacos.

Bom acabamento superficial graças ao desenho Wiper.

Gera canais de fundo plano.

E

F

QD-N..-GM

Avanço radial
Largura de corte (CW), mm

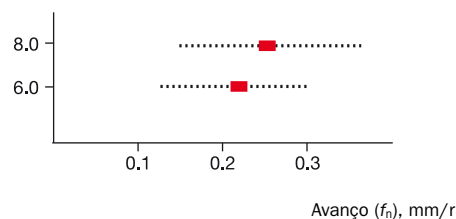

Usinagem de canais em todos os materiais

Controle de cavacos excepcional.

Largura dos cavacos reduzida proporcionando boas superfícies.

G

H

■ = Valor inicial recomendado

Para recomendações de velocidade de corte, veja página B130

Recomendações de dados de corte para o CoroCut® QD

QD-N..-RM

Avanço radial

Largura de corte (CW), mm

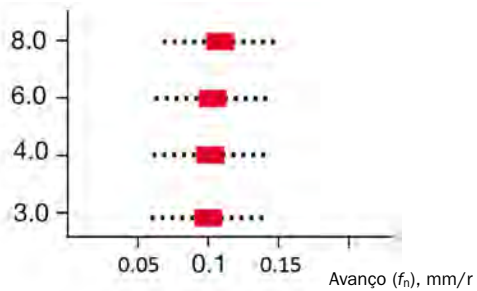

Avanço axial

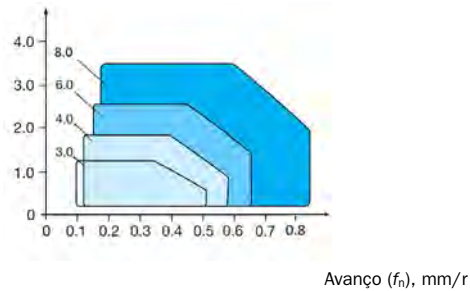
Profundidade de corte (a_p), mm

■ = Valor inicial recomendado

Para recomendações de velocidade de corte, veja página B130

T-Max Q-Cut®

Canais internos



151.3-4G

Escolha de baixo avanço

Avanço radial

Largura da pastilha (W1), mm

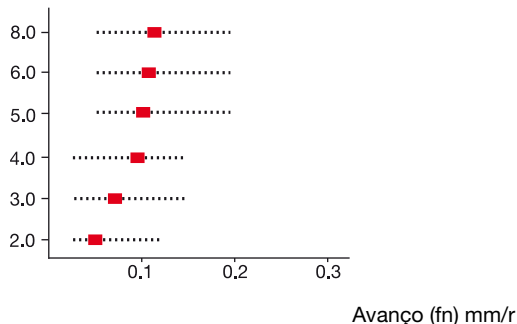

Nota:

As pastilhas tipo 151.3 (-4G, -7G e -7P) podem ser usadas somente com suportes tipo F151.37 ou barras tipo AG151.32

Escolha alternativa para canais internos de furos menores.

Precisão e repetibilidade boas devido às tolerâncias estreitas das pastilhas. Baixas forças de corte e bom controle de cavacos em uma ampla gama de materiais. Aresta de corte viva.

Canais frontais



151.3-7G

Wiper TECHNOLOGY

Escolha de médio avanço

Avanço radial

Largura da pastilha (W1), mm

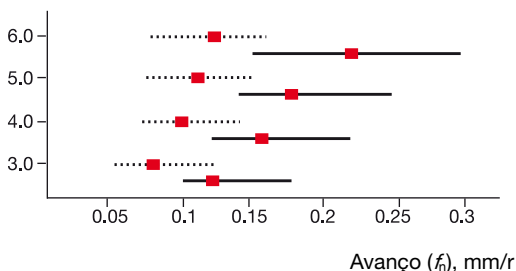

Avanço axial

Profundidade de corte (ap), mm

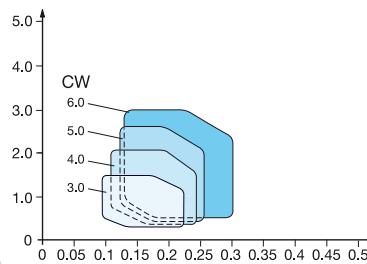

Avanço (fn), mm/r

Primeira escolha para canais frontais.

Bom controle de cavacos tanto na abertura quanto no primeiro corte do canal. Podem ser usinados canais com diâmetros menores. Excelente estabilidade. Para canais frontais em todos os materiais.

Primeira escolha para usinagem de canais/ torneamento interno

Bom controle de cavacos. Gera bom acabamento superficial, devido ao desenho Wiper.



151.3-7P

Avanço radial

Largura da pastilha (W1), mm

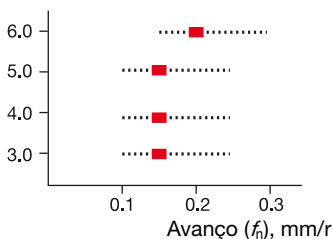

Avanço axial

Profundidade de corte (ap), mm

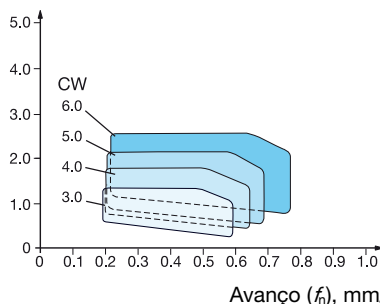

Avanço (fn), mm/r

Para perfilamento em operações de canais frontais.

Bom controle de cavacos tanto na direção axial como radial. Também apropriada para operações de perfilamento interno.

■ = Valor inicial recomendado

Para recomendações de velocidade de corte, veja página B130

CoroThread™**Usinagem de canais circlip****Avanço radial**

Largura da pastilha (W1), mm

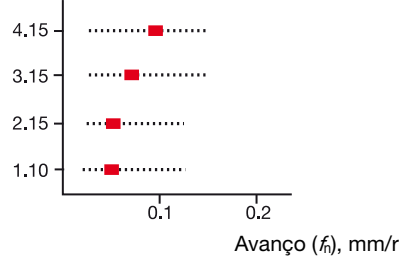
**254R/LG****Alternativa econômica para usinagem de canais circlip.**

Alta produtividade e confiabilidade devido às baixas forças de corte e à pouca vibração. Três arestas de corte proporcionam boa economia.

Recomendada para uso em todos os tipos de materiais.

■ = Valor inicial recomendado

Para recomendações de velocidade de corte, veja página B130

Classes para cortes e canais

P Aços, aços fundidos, ferros maleáveis de cavacos longos.

Classes básicas



GC1125 (HC) - P30 (P15-P45)

Esse metal duro com cobertura PVD é uma excelente classe de uso geral. Uma boa escolha para cortes de tubos em aços. Também muito boa para operações de torneamento e usinagem de canais. Velocidades e avanços de médios a baixos.



GC4325 (HC) - P25 (P10-P40)

Classe de metal duro com cobertura CVD para acabamento ao desbaste de aços e aços fundidos. Essa classe pode lidar com cortes contínuos e cortes interrompidos com altas taxas de remoção de metal. Uma classe para uma ampla área de aplicação e cobertura com tecnologia Inveio™.



GC1135 (HC) - P25 (P10-P45)

Classe de metal duro com cobertura CVD para operações que exigem tenacidade como corte no centro e cortes interrompidos. Uma alternativa "back up" para usinagem de canais e torneamento. Tenacidade da aresta de corte e substrato muito bons. Deve ser usada com velocidades de corte baixas a médias.



GC2135 (HC) - P35 (P20-P50)

Classe de metal duro com cobertura CVD para operações que exigem tenacidade como corte no centro e cortes interrompidos. Uma alternativa "back up" para usinagem de canais e torneamento. Tenacidade da aresta de corte muito boa. Para ser usada com velocidades baixas a médias

Classes complementares



GC3115 (HC) - P15 (P05-P25)

Classe com cobertura CVD e resistência muito alta ao desgaste. Especialmente recomendada para canais e torneamento sob condições estáveis. Graças à sua excelente resistência térmica, também é efetiva em aços endurecidos. Deve ser usada com altas velocidades de corte em condições boas.



GC1145 (HC) - P45 (P25-P50)

Classe com cobertura PVD adequada em operações de cortes e aplicações que exijam alta tenacidade da aresta. Trabalha bem em materiais abrasivos. Deve ser usada com baixas velocidades de corte.



CT525 (HT) - P10 (P01-P15)

Classe cermet sem cobertura com excelente resistência à oxidação e abrasão. Para acabamento superficial de alta qualidade quando usinar canais em aços baixa-liga e com liga em boas condições. Avanços e velocidades de corte moderados.



GC1025 (HC) - P25 (P15-P45)

Uma excelente classe de metal duro com cobertura PVD e de uso geral para usinagem de peças pequenas. Essa classe trabalha muito bem em aços baixo-carbono e outros materiais abrasivos. Velocidades e avanços de médios a baixos.

Letras-símbolo especificando a designação de materiais de corte duros:

Metais duros:

HW	Metal duro sem cobertura contendo principalmente carboneto de tungstênio (WC)
HT	Metal duro sem cobertura, também chamado cermet, contendo principalmente carbonetos de titânio (TIC) ou nitretos de titânio (TIN) ou ambos
HC	Metais duros como acima, porém com cobertura

Cerâmicas:

CA	Cerâmicas à base de óxido contendo principalmente óxido de alumínio (Al ₂ O ₃)
CM	Cerâmicas mistas contendo principalmente óxido de alumínio (Al ₂ O ₃) e outros elementos além de óxidos
CN	Cerâmicas à base de nitreto, principalmente nitreto de silício (Si ₃ N ₄)
CC	Cerâmicas como acima, porém com cobertura

Diamante:

DP	Diamante policristalino ¹⁾
----	---------------------------------------

Nitreto de boro:

BN	Nitreto de boro policristalino ¹⁾
----	--

¹⁾ Diamante policristalino e nitreto de boro policristalino são também denominados materiais de corte superduros.

Classes para cortes e canais

M Aços inoxidáveis austeníticos, martensíticos e ferríticos, aços fundidos, aços-manganês, ligas de ferros fundidos, ferros maleáveis, aços de corte livre.

Classes básicas



GC1135 (HC) – M25 (M10-M35)

Classe de metal duro com cobertura CVD para cortes e outras operações que exijam tenacidade. Tenacidade da aresta de corte e substrato muito bons. Deve ser usada com velocidades de corte baixas.



GC1145 (HC) - M40 (M30-M40)

Classe com cobertura PVD adequada para operações de cortes e aplicações que exijam alta tenacidade da aresta. Trabalha bem em materiais abrasivos. O substrato tem uma tenacidade extremamente boa. A classe deve ser usada com baixas velocidades de corte ou em combinação com ferramentas de refrigeração de alta precisão.



GC2135 (HC) – M30 (M20-M40)

Classe de metal duro com cobertura CVD para cortes e outras operações que exijam tenacidade. Tenacidade da aresta de corte e substrato muito bons. Deve ser usada com velocidades de corte baixas.



GC1125 (HC) – M25 (M15-M35)

Classe de metal duro com cobertura PVD e uma combinação de alta resistência ao desgaste e boa segurança da aresta. Para operações de usinagem de canais e torneamento, bem como cortes de tubos especialmente. Velocidades de corte médias a baixas

Classes complementares



GC1105 (HC) - M15 (M05 - M20)

Classe de metal duro com cobertura PVD com alta resistência ao calor e boa resistência contra deformação plástica, garante alto desempenho com desgaste de flanco uniforme. Adequada para usinagem de canais e perfilamento em condições estáveis com altas velocidades.



GC1025 (HC) - M25 (M15-M35)

Classe de metal duro com cobertura PVD com uma combinação de alta resistência ao desgaste e boa segurança da aresta. Deve ser usada para cortes e canais na usinagem de peças pequenas. Velocidades de corte médias a baixas.



CT525 (HT) – M10 (M05-M15)

Classe de cermet sem cobertura com excelente resistência à oxidação e abrasão. Para excelente acabamento superficial na usinagem de canais sob boas condições. Avanços e velocidades de corte moderados.



GC1115 (HC) – M15 (M05-M25)

Classe de metal duro com cobertura PVD . A classe tem alta dureza a quente e boa resistência contra deformação plástica, combinada com boa segurança da aresta de corte. Isso assegura tenacidade, desgaste de flanco uniforme e alto desempenho da aresta. Para operações de perfilamento e usinagem de canais.

Letras-símbolo especificando a designação de materiais de corte duros:

Metais duros:

HW Metal duro sem cobertura contendo principalmente carboneto de tungstênio (WC)

HT Metal duro sem cobertura, também chamado cermet, contendo principalmente carbonetos de titânio (TIC) ou nitretos de titânio (TIN) ou ambos

HC Metais duros como acima, porém com cobertura

Cerâmicas:

CA Cerâmicas à base de óxido contendo principalmente óxido de alumínio (Al_2O_3)

CM Cerâmicas mistas contendo principalmente óxido de alumínio (Al_2O_3) e outros elementos além de óxidos

CN Cerâmicas à base de nitreto, principalmente nitreto de silício (Si_3N_4)

CC Cerâmicas como acima, porém com cobertura

Diamante:

DP Diamante policristalino¹⁾

Nitreto de boro:

BN Nitreto de boro policristalino¹⁾

¹⁾ Diamante policristalino e nitreto de boro policristalino são também denominados materiais de corte superduros.

Classes para cortes e canais

K Ferros fundidos, ferros fundidos coquilhados, ferros maleáveis de cavacos curtos.

Classes básicas



GC4325 (HC) - K25 (K10 - K35)

Classe de uso geral com cobertura CVD e excelente combinação de alta resistência ao desgaste e boa segurança da aresta. Para uso em operações de canais e torneamento em velocidades de corte de média a alta. Também boa para corte de tubos.



GC3115 (HC) – K15 (K05-K25)

Uma classe com cobertura CVD para velocidades de corte altas na usinagem de canais e torneamento em boas condições. Devido à sua excelente dureza a quente, também é eficiente em ferros fundidos endurecidos.



GC1125 (HC) - K30 (K15-K35)

Classe de uso geral com cobertura PVD para operações que exijam tenacidade e cortes interrompidos. Essa classe tem uma boa segurança da aresta devido à cobertura superior. Deve ser usada com velocidades de corte de médias a baixas



GC1135 (HC) – K20 (K10-K30)

Classe de metal duro com cobertura CVD para cortes e outras operações que exijam tenacidade. Tenacidade da aresta de corte e substrato muito bons. Deve ser usada em velocidades de corte baixas.

Classes complementares



GC3020 (HC) – K15 (K05-K25)

Classe com cobertura CVD altamente resistente ao desgaste para altas velocidades de corte em canais e torneamento sob condições boas. Graças à sua excelente resistência térmica, também é efetiva para ferros fundidos duros.



H13A (HW) – K20 (K10-K30)

Classe sem cobertura com boa resistência ao desgaste por abrasão e tenacidade. Para operações de cortes/canais



GC1025 (HC) - K30 (K15-K35)

Classe de uso geral com cobertura PVD para operações que exijam tenacidade e cortes interrompidos. Deve ser usada com velocidades de corte de médias a baixas.

Letras-símbolo especificando a designação de materiais de corte duros:

Metais duros:

- HW Metal duro sem cobertura contendo principalmente carboneto de tungstênio (WC)
- HT Metal duro sem cobertura, também chamado cermet, contendo principalmente carbonetos de titânio (TIC) ou nitretos de titânio (TIN) ou ambos
- HC Metais duros como acima, porém com cobertura

Cerâmicas:

- CA Cerâmicas à base de óxido contendo principalmente óxido de alumínio (Al₂O₃)
- CM Cerâmicas mistas contendo principalmente óxido de alumínio (Al₂O₃) e outros elementos além de óxidos
- CN Cerâmicas à base de nitreto, principalmente nitreto de silício (Si₃N₄)
- CC Cerâmicas como acima, porém com cobertura

Diamante:

- DP Diamante policristalino¹⁾

Nitreto de boro:

- BN Nitreto de boro policristalino¹⁾

¹⁾ Diamante policristalino e nitreto de boro policristalino são também denominados materiais de corte superduros.

Classes para cortes e canais

N

Metais não-ferrosos

Classes básicas



GC1125 (HC) - N25 (N15-N35)

Classe com cobertura PVD para operações que exijam tenacidade, recomendada para cortes interrompidos

Classes complementares



GC1105 (HC) - N15 (N05-N25)

Classe com cobertura PVD e excelente adesão em arestas vivas, garantindo tenacidade, desgaste de flanco uniforme e alto desempenho.



H13A (HW) – N20 (N10-N30)

Classe de metal duro sem cobertura. Combina boa resistência ao desgaste por abrasão e tenacidade. Para cortes e canais.



GC1025 (HC) – N25 (N15-N30)

Uma classe com cobertura PVD para operações que exijam tenacidade. Recomendada para usinagem de peças pequenas.



H10 (HW) – N10 (N05-N15)

Classe de metal duro sem cobertura com boa agudeza da aresta. Recomendada para cortes interrompidos.



CD10 (DP) – N01 (N01-N15)

Uma classe de diamante policristalino (PCD) recomendada para perfilamento de metais não ferrosos abrasivos e materiais não metálicos em condições estáveis. Acabamento superficial muito bom.

Letras-símbolo especificando a designação de materiais de corte duros:

Metais duros:

HW Metal duro sem cobertura contendo principalmente carboneto de tungstênio (WC)

HT Metal duro sem cobertura, também chamado cermet, contendo principalmente carbonetos de titânio (TIC) ou nitretos de titânio (TIN) ou ambos

HC Metais duros como acima, porém com cobertura

Cerâmicas:

CA Cerâmicas à base de óxido contendo principalmente óxido de alumínio (Al_2O_3)

CM Cerâmicas mistas contendo principalmente óxido de alumínio (Al_2O_3) e outros elementos além de óxidos

CN Cerâmicas à base de nitreto, principalmente nitreto de silício (Si_3N_4)

CC Cerâmicas como acima, porém com cobertura

Diamante:

DP Diamante policristalino¹⁾

Nitreto de boro:

BN Nitreto de boro policristalino¹⁾

¹⁾ Diamante policristalino e nitreto de boro policristalino são também denominados materiais de corte superduros.

Classes para cortes e canais

S Super ligas e ligas resistentes ao calor

Classes básicas



GC1105 (HC) - S15 (S10-S20)

Classe de metal duro com cobertura PVD de alta dureza e boa resistência contra deformação plástica propiciando excelente desempenho e desgaste de flanco uniforme. Primeira escolha para usinagem de canais e perfilamento.



GC1145 (HC) – S40 (S30-S40)

Classe de metal duro com cobertura PVD. Primeira escolha para cortes quando for necessária uma aresta de corte segura. Deve ser usada com baixas velocidades de corte



S05F (HC) - S10 (S05-S15)

Classe de metal duro com cobertura CVD. Deve ser usada para operações de acabamento com altas velocidades e perfilamento em desbaste.



GC1125 (HC) - S25 (S15-S35)

Classe com cobertura PVD para operações que exijam tenacidade, recomendada para cortes interrompidos. Deve ser usada para velocidades de corte baixas.



H13A (HW) – S15 (S10-S30)

Classe de metal duro sem cobertura. Combina boa resistência ao desgaste por abrasão e tenacidade para cortes e canais. Primeira escolha para titânio.

Classes complementares



CB7015 (BN) – S15 (S05-S25)

Composto de nitreto cúbico de boro adequado para superligas resistentes ao calor. Essa classe permite arestas de corte otimizadas para acabamento superficial e baixas profundidades de corte.



GC1115 (HC) – S20 (S10-S25)

Classe de metal duro com cobertura PVD com alta dureza combinada à segurança superior da aresta de corte. A boa resistência ao desgaste tipo entalhe faz com seja a classe adequada para uso em materiais difíceis.



GC1135 (HC) – S25 (S10-S35)

Classe com cobertura PVD para operações que exijam tenacidade. Deve ser usada em baixas velocidades de corte.



GC2135 (HC) - S30 (S20-S40)

Classe de metal duro com cobertura CVD para operações que exigem tenacidade como corte no centro e cortes interrompidos.



CC670 (CA) – S10 (S05-S25)

Cerâmica à base de óxido de alumínio, reforçada com whiskers, e com excelente tenacidade. Deve ser usada em condições favoráveis.



GC1025 (HC) – S25 (S15-S35)

Classe com cobertura PVD para operações que exijam tenacidade. Recomendada para usinagem de peças pequenas. Deve ser usada com baixas velocidades de corte.

Letras-símbolo especificando a designação de materiais de corte duros:

Metais duros:

HW	Metal duro sem cobertura contendo principalmente carboneto de tungstênio (WC)
HT	Metal duro sem cobertura, também chamado cermet, contendo principalmente carbonetos de titânio (TIC) ou nitretos de titânio (TIN) ou ambos
HC	Metais duros como acima, porém com cobertura

Cerâmicas:

CA	Cerâmicas à base de óxido contendo principalmente óxido de alumínio (Al ₂ O ₃)
CM	Cerâmicas mistas contendo principalmente óxido de alumínio (Al ₂ O ₃) e outros elementos além de óxidos
CN	Cerâmicas à base de nitreto, principalmente nitreto de silício (Si ₃ N ₄)
CC	Cerâmicas como acima, porém com cobertura

Diamante:

DP	Diamante policristalino ¹⁾
----	---------------------------------------

Nitreto de boro:

BN	Nitreto de boro policristalino ¹⁾
----	--

¹⁾ Diamante policristalino e nitreto de boro policristalino são também denominados materiais de corte superduros.

Classes para cortes e canais

H

Materiais endurecidos

B

Classes básicas

**CB7015 (BN)** - H15 (H05-H20)

Composto de nitreto cúbico de boro para materiais ferrosos endurecidos. Classe adequada para cortes contínuos e interrompidos.

C

**CB7025 (BN)** - H15 (H10-H20)

Um compósito de nitreto cúbico de boro para materiais ferrosos endurecidos.

Adequada para cortes com interrupções significativas, com velocidades médias em aços endurecidos por cementação e aços para rolamento.

D

E

F

G

Letras-símbolo especificando a designação de materiais de corte duros:

Metais duros:

HW Metal duro sem cobertura contendo principalmente carboneto de tungstênio (WC)

HT Metal duro sem cobertura, também chamado cermet, contendo principalmente carbonetos de titânio (TIC) ou nitretos de titânio (TIN) ou ambos

HC Metais duros como acima, porém com cobertura

Cerâmicas:

CA Cerâmicas à base de óxido contendo principalmente óxido de alumínio (Al_2O_3)

CM Cerâmicas mistas contendo principalmente óxido de alumínio (Al_2O_3) e outros elementos além de óxidos

CN Cerâmicas à base de nitreto, principalmente nitreto de silício (Si_3N_4)

CC Cerâmicas como acima, porém com cobertura

Diamante:

DP Diamante policristalino¹⁾

Nitreto de boro:

BN Nitreto de boro policristalino¹⁾

¹⁾ Diamante policristalino e nitreto de boro policristalino são também denominados materiais de corte superduros.

Torneamento de rosca

CoroThread® 266 C4

Pastilhas C5-C29
Ferramentas externas C30-C38
Ferramentas internas C39-C43

T-Max® U-Lock C44

Pastilhas C45-C50
Ferramentas internas C51-C54

CoroCut® XS C55

Pastilhas C56-C58
Ferramentas externas B99-B100

CoroTurn® XS C59

Ferramentas de corte C60-C65
Adaptadores F2

CoroCut® MB C66

Ferramentas de corte C67-C72
Adaptadores F2

Perfis de rosca

	Perfil em V 60° sem formador de crista		Perfil em V 55° sem formador de crista		Métrica 60° Perfil completo		UN 60° Perfil completo		Whitworth 55° (BSW, BSF, BSP) Perfil completo	
	Interna	Externa	Interna	Externa	Interna	Externa	Interna	Externa	Interna	Externa
					ISO 965-1998 Tolerância classe 6		ISO 5864-1978 Tolerância de classe 2A, ext. Classe de tolerância 2B, int.		ISO 228-1982 BS 2779-1973 BS 84-1956 Tolerância A da classe	
CoroThread® 266	C5	C5	C6	C6	C9-C10	C7-C8	C13-C14	C11-C12	C16	C15
T-Max U-Lock®	C45		C46		C47		C48		C49	
CoroCut® XS		C56				C57		C58		C58
CoroTurn® XS	C60				C61		C62		C63	
CoroCut® MB	C67				C68		C69		C70	





	NPT 60° (NPSC, NPTR, LINE PIPE) perfil completo		BSPT 55° Perfil completo		NPTF 60° Perfil completo		Redonda 30° Perfil completo		MJ 60° Perfil completo	
	Interna	Externa	Interna	Externa	Interna	Externa	Interna	Externa	Interna	Externa
	ANSI B.1.20.1-1983		ISO 7/1 BS21:1985		ANSI B1.20.3-1976 Classe de tolerância 2		DIN 405. Classe de tolerância 7 no diâmetro efetivo. Classe de tolerância 6 em diâmetro maior (externo) e menor (interno).		ISO 5855-1983 Classe de tolerância 4 no diâmetro do passo. Classe de tolerância 6 em diâmetro maior (externo) e menor (interno).	
CoroThread® 266	C18	C17	C19	C19	C20	C20	C21	C21		C22
T-Max U-Lock®	C50									
CoroCut® XS		C58								
CoroTurn® XS	C64									
CoroCut® MB	C71									

	UNJ 60° Perfil completo		ISO Trapezoidal 30° Perfil da crista chanfrado		ACME 29° Perfil da crista chanfrado		STUB-ACME 29° Perfil da crista chanfrado		API 60° Perfil completo para conexões a 90 graus	
	Interna	Externa	Interna	Externa	Interna	Externa	Interna	Externa	Interna	Externa
	ISO 3161-1977 BS 4084-1978 Classe de tolerância 3A		ISO 2901-2904 DIN 103-1977 Classe de tolerância 7		ANSI B1.5-1988 Classe de tolerância 2G		ANSI B1.8-1988 Classe de tolerância 2G		API spec.7	
CoroThread® 266		C23	C24	C24	C25	C25	C26	C26	C27	C27
T-Max U-Lock®										
CoroCut® XS										
CoroTurn® XS			C65							
CoroCut® MB					C72		C72			



	API Round 60° Perfil completo		API Perfil completo para carcaças e tubos	
	Interna	Externa	Interna	Externa
	API spec.5B		API spec.5B	
CoroThread® 266	C28	C28	C29	C29
T-Max U-Lock®				
CoroCut® XS				
CoroTurn® XS				
CoroCut® MB				

CoroThread® 266

Ferramentas externas



	Unidade de corte CoroThread® 266 para torneamento de roscas	Página C30-C32
	CoroThread® 266 com haste convencional para torneamento de roscas	Página C34-C36
	CoroThread® 266 QS com haste convencional para torneamento de roscas	Página C37
	Cabeça CoroThread® 266 para torneamento de roscas	Página C38

Ferramentas internas

	Unidade de corte CoroThread® 266 para torneamento de roscas	Página C39
	Barra de mandril CoroThread® 266 para torneamento de roscas	Página C40-C41
	Cabeça CoroThread® 266 para torneamento de roscas	Página C42-C43

T-Max® U-Lock

Ferramentas internas

	Unidade de corte T-Max® U-Lock para torneamento de roscas	Página C51
	Barra de mandril T-Max® U-Lock para torneamento de roscas	Página C52-C53
	Cabeça T-Max® U-Lock para torneamento de roscas	Página C54

CoroCut® XS

	CoroCut® XS	Página B99-B100
---	-------------	-----------------

CoroTurn® XS

	Adaptador CoroTurn® XS	Página F2
---	------------------------	-----------

CoroCut® MB

	Adaptador CoroCut® MB	Página F2
---	-----------------------	-----------

CoroThread® 266

Torneamento de roscas ultrarrígido para todos os tipos de rosca

Aplicação

- Roscas externas
- Roscas internas

Área de aplicação ISO:



Características e benefícios

- Tempo de máquina parado reduzido
- Acabamento superficial excelente devido à excepcional estabilidade
- Três arestas de corte vivas para roscas de alta qualidade
- Pastilhas multipontas disponíveis requerem menos passes o que aumenta a produtividade
- Ampla gama de ferramentas standard e pastilhas para perfil de roscas
- Interface tipo trilho exclusiva entre a pastilha e o tip seat
- Boa indexação da aresta
- Fácil de montar a pastilha corretamente



A refrigeração de alta precisão superior controla a quebra de cavacos para usinagem segura e a refrigeração inferior controla a temperatura para vida útil da ferramenta mais longa e previsível.

www.sandvik.coromant.com/corothread266

Pastilhas

- Geometrias e classes de pastilha para todos os materiais
- Pastilhas Tailor Made para quase todos os perfis de roscas e passos



Standard
Geometria A

Viva
Geometria F

Quebra-cavacos
Geometria C

Ferramentas

- Unidades de corte Coromant Capto®
- Ferramentas convencionais
- Barras de mandrilar
- Cabeças CoroTurn® SL



Três tipos diferentes de pastilhas para rosqueamento

Perfil completo

Alta produtividade



Perfil em V

Estoque mínimo de ferramentas



Multidentados

Produção em grande escala econômica



Fixação iLock™ segura

A pastilha com canais se encaixa rigidamente nos trilhos T do bolsão eliminando qualquer possibilidade de movimento causado pelas variações de força de corte.

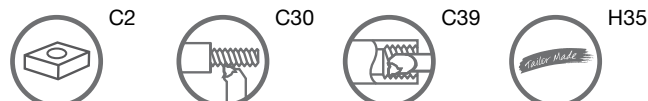

Pastilha CoroThread® 266 para torneamento de roscas

Perfil em V 60° sem formador de crista

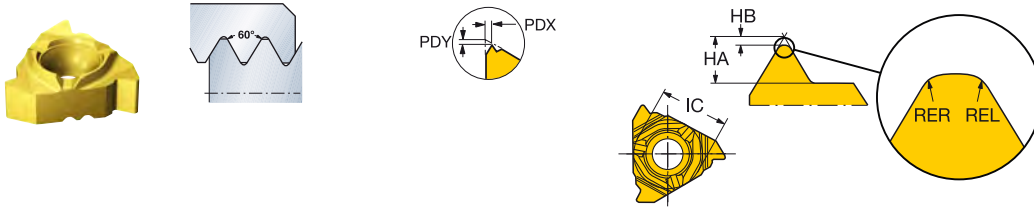

Roscas externas versão direita

TPN	TPX	TPIN	TPIX	NT	Código para pedido	Dimensões, mm																									
						P			M			K			N			S			H										
						1020	1125	1135	1020	1125	1135	1020	1125	1135	1020	1125	1135	1020	1125	1135	1020	1125	1135	7015	RER	REL	HA	HB	PDX	PDY	
16	1.0	2.0	12.0	24.0	1	266RG-16VM01A001EE																		*	0.13	0.13	1.68	0.14	1.00	1.03	
	1.0	2.0	12.0	24.0	1	266RG-16VM01A001M	*	*	*	*	*	*	*	*	*	*	*	*	*	*	*	*	*	*	*	0.13	0.13	1.68	0.14	1.00	1.03
	1.0	2.0	12.0	24.0	1	266RG-16VM01C001M	*	*	*	*	*	*	*	*	*	*	*	*	*	*	*	*	*	*	*	0.13	0.13	1.68	0.14	1.00	1.03
	1.0	2.0	12.0	24.0	1	266RG-16VM01F001E																		*	0.13	0.13	1.68	0.14	1.00	1.03	
	1.5	3.0	8.0	16.0	1	266RG-16VM01A002EE																		*	0.20	0.20	2.64	0.20	1.50	1.03	
	1.5	3.0	8.0	16.0	1	266RG-16VM01A002M	*	*	*	*	*	*	*	*	*	*	*	*	*	*	*	*	*	*	*	0.20	0.20	2.64	0.20	1.50	1.03
	1.5	3.0	8.0	16.0	1	266RG-16VM01C002M	*	*	*	*	*	*	*	*	*	*	*	*	*	*	*	*	*	*	*	0.20	0.20	2.64	0.20	1.50	1.03
	1.5	3.0	8.0	16.0	1	266RG-16VM01F002E																		*	0.20	0.20	2.64	0.20	1.50	1.03	
22	3.5	6.0	4.0	7.0	1	266RG-22VM01A001M	*	*	*	*	*	*	*	*	*	*	*	*	*	*	*	*	*	*	*	0.48	0.48	4.92	0.48	2.90	0.39
	3.5	6.0	4.0	7.0	1	266RG-22VM01F001E	*	*	*	*	*	*	*	*	*	*	*	*	*	*	*	*	*	*	*	0.48	0.48	4.92	0.48	2.90	0.39

Roscas externas versão esquerda

TPN	TPX	TPIN	TPIX	NT	Código para pedido	Dimensões, mm																									
						P			M			K			N			S			H										
						1020	1125	1135	1020	1125	1135	1020	1125	1135	1020	1125	1135	1020	1125	1135	1020	1125	1135	RER	REL	HA	HB	PDX	PDY		
16	1.0	2.0	12.0	24.0	1	266LG-16VM01A001M	*	*	*	*	*	*	*	*	*	*	*	*	*	*	*	*	*	*	*	0.13	0.13	1.68	0.14	1.00	1.03
	1.5	3.0	8.0	16.0	1	266LG-16VM01A002M	*	*	*	*	*	*	*	*	*	*	*	*	*	*	*	*	*	*	*	0.20	0.20	2.64	0.20	1.50	0.99
22	3.5	6.0	4.0	7.0	1	266LG-22VM01A001M	*	*	*	*	*	*	*	*	*	*	*	*	*	*	*	*	*	*	*	0.48	0.48	4.92	0.48	2.90	0.39

Roscas internas versão direita

TPN	TPX	TPIN	TPIX	NT	Código para pedido	Dimensões, mm																									
						P			M			K			N			S			H										
						1020	1125	1135	1020	1125	1135	1020	1125	1135	1020	1125	1135	1020	1125	1135	7015	RER	REL	HA	HB	PDX	PDY				
16	1.0	2.0	12.0	24.0	1	266RL-16VM01A001M																		*	0.06	0.06	1.45	0.06	1.00	1.01	
	1.0	2.0	12.0	24.0	1	266RL-16VM01C001M	*	*	*	*	*	*	*	*	*	*	*	*	*	*	*	*	*	*	*	0.06	0.06	1.45	0.06	1.00	1.02
	1.0	2.0	12.0	24.0	1	266RL-16VM01F001E																		*	0.06	0.06	1.45	0.06	1.00	1.02	
	1.5	3.0	8.0	16.0	1	266RL-16VM01A002EE																		*	0.09	0.09	2.54	0.09	1.50	1.01	
	1.5	3.0	8.0	16.0	1	266RL-16VM01A002M	*	*	*	*	*	*	*	*	*	*	*	*	*	*	*	*	*	*	*	0.09	0.09	2.54	0.09	1.50	1.01
	1.5	3.0	8.0	16.0	1	266RL-16VM01C002M	*	*	*	*	*	*	*	*	*	*	*	*	*	*	*	*	*	*	*	0.09	0.09	2.54	0.09	1.50	1.03
	1.5	3.0	8.0	16.0	1	266RL-16VM01F002E																		*	0.09	0.09	2.54	0.09	1.50	1.03	
22	3.5	6.0	4.0	7.0	1	266RL-22VM01A001M	*	*	*	*	*	*	*	*	*	*	*	*	*	*	*	*	*	*	*	0.26	0.26	4.35	0.26	2.50	0.77
	3.5	6.0	4.0	7.0	1	266RL-22VM01F001E	*	*	*	*	*	*	*	*	*	*	*	*	*	*	*	*	*	*	*	0.18	0.18	4.35	0.26	2.50	0.77

Roscas internas versão esquerda

TPN	TPX	TPIN	TPIX	NT	Código para pedido	Dimensões, mm																									
						P			M			K			N			S			H										
						1020	1125	1135	1020	1125	1135	1020	1125	1135	1020	1125	1135	1020	1125	1135	RER	REL	HA	HB	PDX	PDY					
16	1.0	2.0	12.0	24.0	1	266LL-16VM01A001M	*	*	*	*	*	*	*	*	*	*	*	*	*	*	*	*	*	*	*	0.06	0.06	1.45	0.06	1.00	1.01
	1.5	3.0	8.0	16.0	1	266LL-16VM01A002M	*	*	*	*	*	*	*	*	*	*	*	*	*	*	*	*	*	*	*	0.09	0.09	2.54	0.09	1.50	1.01
22	3.5	6.0	4.0	7.0	1	266LL-22VM01A001M	*	*	*	*	*	*	*	*	*	*	*	*	*	*	*	*	*	*	*	0.26	0.26	4.35	0.26	2.75	0.77

R = versão direita, L = versão esquerda

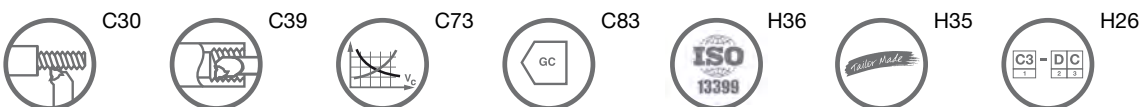

Pastilha CoroThread® 266 para torneamento de roscas

Perfil em V 55° sem formador de crista

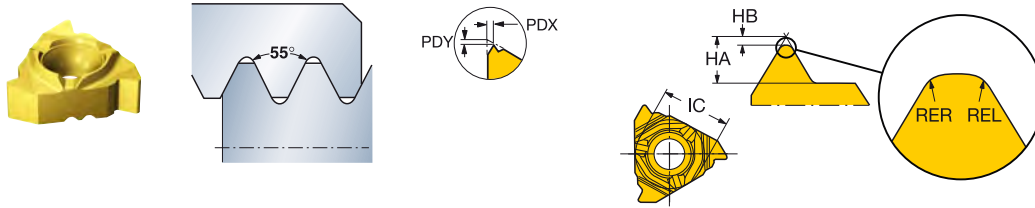

Roscas externas versão direita

TPIN	TPIX	NT	Código para pedido	P						M			K			N			S			H			Dimensões, mm									
				1020	1125	1020	1125	1135	1020	1125	1135	1020	1125	1135	1020	1125	1135	1020	1125	1135	1020	1125	1135	RER	REL	HA	HB	PDX	PDY					
				☆	★	☆	★	☆	★	☆	★	☆	★	☆	★	☆	★	☆	★	☆	★	☆	★	☆	★	☆	★	☆	★	☆	★			
16	14.0	28.0	1	266RG-16VW01A001M	★	☆	☆	★	☆	★	☆	★	☆	★	☆	★	☆	★	☆	★	☆	★	☆	★	☆	★	☆	★	0.11	0.11	1.68	0.14	1.00	1.03
	14.0	28.0	1	266RG-16VW01C001M	★	☆	☆	★	☆	★	☆	★	☆	★	☆	★	☆	★	☆	★	☆	★	☆	★	☆	★	☆	★	0.11	0.11	1.68	0.13	1.00	1.03
	14.0	28.0	1	266RG-16VW01F001E	★	☆	☆	★	☆	★	☆	★	☆	★	☆	★	☆	★	☆	★	☆	★	☆	★	☆	★	☆	★	0.11	0.11	1.68	0.14	1.00	1.01
	8.0	14.0	1	266RG-16VW01A002M	★	☆	☆	★	☆	★	☆	★	☆	★	☆	★	☆	★	☆	★	☆	★	☆	★	☆	★	☆	★	0.23	0.23	2.79	0.26	1.50	1.03
	8.0	14.0	1	266RG-16VW01C002M	★	☆	☆	★	☆	★	☆	★	☆	★	☆	★	☆	★	☆	★	☆	★	☆	★	☆	★	☆	★	0.23	0.23	2.79	0.26	1.50	1.03
	8.0	14.0	1	266RG-16VW01F002E	★	☆	☆	★	☆	★	☆	★	☆	★	☆	★	☆	★	☆	★	☆	★	☆	★	☆	★	☆	★	0.23	0.23	2.79	0.26	1.50	0.99
22	4.0	7.0	1	266RG-22VW01A001M	☆	★	☆	★	☆	★	☆	★	☆	★	☆	★	☆	★	☆	★	☆	★	☆	★	☆	★	☆	★	0.48	0.48	5.23	0.53	2.75	0.10
	4.0	7.0	1	266RG-22VW01F001E	★	☆	☆	★	☆	★	☆	★	☆	★	☆	★	☆	★	☆	★	☆	★	☆	★	☆	★	☆	★	0.48	0.48	5.23	0.53	2.75	0.10

Roscas externas versão esquerda

TPIN	TPIX	NT	Código para pedido	P			M			K			N			S			H			Dimensões, mm						
				1020	1125	1135	1020	1125	1135	1020	1125	1135	1020	1125	1135	1020	1125	1135	1020	1125	1135	RER	REL	HA	HB	PDX	PDY	
				☆	★	☆	★	☆	★	☆	★	☆	★	☆	★	☆	★	☆	★	☆	★	☆	★	☆	★	☆	★	☆
16	14.0	28.0	1	266LG-16VW01A001M	★	☆	☆	★	☆	★	☆	★	☆	★	☆	★	☆	★	☆	★	☆	★	0.11	0.11	1.68	0.13	1.00	1.03
	8.0	14.0	1	266LG-16VW01A002M	★	☆	☆	★	☆	★	☆	★	☆	★	☆	★	☆	★	☆	★	☆	★	0.23	0.23	2.79	0.26	1.50	1.03
22	4.0	7.0	1	266LG-22VW01A001M	★	☆	☆	★	☆	★	☆	★	☆	★	☆	★	☆	★	☆	★	☆	★	0.48	0.48	5.23	0.53	2.75	0.10

Roscas internas versão direita

TPIN	TPIX	NT	Código para pedido	P			M			K			N			S			H			Dimensões, mm						
				1020	1125	1135	1020	1125	1135	1020	1125	1135	1020	1125	1135	1020	1125	1135	1020	1125	1135	RER	REL	HA	HB	PDX	PDY	
				☆	★	☆	★	☆	★	☆	★	☆	★	☆	★	☆	★	☆	★	☆	★	☆	★	☆	★	☆	★	☆
16	14.0	28.0	1	266RL-16VW01A001M	★	☆	☆	★	☆	★	☆	★	☆	★	☆	★	☆	★	☆	★	☆	★	0.11	0.11	1.60	0.12	1.00	1.01
	14.0	28.0	1	266RL-16VW01C001M	★	☆	☆	★	☆	★	☆	★	☆	★	☆	★	☆	★	☆	★	☆	★	0.11	0.11	1.60	0.12	1.00	1.01
	14.0	28.0	1	266RL-16VW01F001E	★	☆	☆	★	☆	★	☆	★	☆	★	☆	★	☆	★	☆	★	☆	★	0.11	0.11	1.60	0.12	1.00	1.01
	8.0	14.0	1	266RL-16VW01A002M	★	☆	☆	★	☆	★	☆	★	☆	★	☆	★	☆	★	☆	★	☆	★	0.23	0.23	2.80	0.25	1.50	1.01
	8.0	14.0	1	266RL-16VW01C002M	★	☆	☆	★	☆	★	☆	★	☆	★	☆	★	☆	★	☆	★	☆	★	0.23	0.23	2.80	0.24	1.50	1.03
	8.0	14.0	1	266RL-16VW01F002E	★	☆	☆	★	☆	★	☆	★	☆	★	☆	★	☆	★	☆	★	☆	★	0.23	0.23	2.80	0.24	1.50	0.99
22	4.0	7.0	1	266RL-22VW01A001M	☆	★	☆	★	☆	★	☆	★	☆	★	☆	★	☆	★	☆	★	☆	★	0.47	0.47	5.18	0.53	2.75	0.19
	4.0	7.0	1	266RL-22VW01F001E	★	☆	☆	★	☆	★	☆	★	☆	★	☆	★	☆	★	☆	★	☆	★	0.47	0.47	5.18	0.53	2.75	0.19

Roscas internas versão esquerda

TPIN	TPIX	NT	Código para pedido	P			M			K			N			S			H			Dimensões, mm						
				1020	1125	1135	1020	1125	1135	1020	1125	1135	1020	1125	1135	1020	1125	1135	1020	1125	1135	RER	REL	HA	HB	PDX	PDY	
				☆	★	☆	★	☆	★	☆	★	☆	★	☆	★	☆	★	☆	★	☆	★	☆	★	☆	★	☆	★	☆
16	14.0	28.0	1	266LL-16VW01A001M	★	☆	☆	★	☆	★	☆	★	☆	★	☆	★	☆	★	☆	★	☆	★	0.11	0.11	1.60	0.12	1.00	1.03
	8.0	14.0	1	266LL-16VW01A002M	★	☆	☆	★	☆	★	☆	★	☆	★	☆	★	☆	★	☆	★	☆	★	0.23	0.23	2.80	0.25	1.50	1.01
22	4.0	7.0	1	266LL-22VW01A001M	★	☆	☆	★	☆	★	☆	★	☆	★	☆	★	☆	★	☆	★	☆	★	0.47	0.47	5.18	0.53	2.75	0.19

R = versão direita, L = versão esquerda



Pastilha CoroThread® 266 para torneamento de roscas

Perfil completo 60° métrico

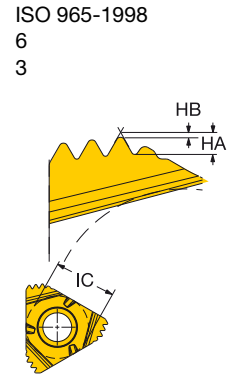
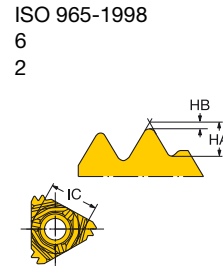
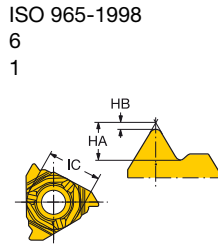
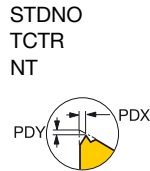
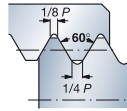

Roscas externas versão direita

TP	NT	Código para pedido	Dimensões, mm																					
			P			M			K			N			S			H			HA	HB	PDX	PDY
			1020	1125	1135	1020	1125	1135	1020	1125	1135	1020	1125	1135	1020	1125	1135	1020	1125	1135				
16	0.50	1	266RG-16MM01A050M	*	*	*	*	*	*	*	*	*	*	*	*	*	*	*	*	*	0.37	0.08	0.50	1.32
	0.75	1	266RG-16MM01A075M	*	*	*	*	*	*	*	*	*	*	*	*	*	*	*	*	*	0.56	0.11	0.50	1.32
	0.80	1	266RG-16MM01F080E	*	*	*	*	*	*	*	*	*	*	*	*	*	*	*	*	*	0.60	0.11	0.60	1.32
	1.00	1	266RG-16MM01A100M	*	*	*	*	*	*	*	*	*	*	*	*	*	*	*	*	*	0.75	0.15	0.80	1.32
	1.00	1	266RG-16MM01C100M	*	*	*	*	*	*	*	*	*	*	*	*	*	*	*	*	*	0.75	0.15	0.80	1.32
	1.00	1	266RG-16MM01F100E	*	*	*	*	*	*	*	*	*	*	*	*	*	*	*	*	*	0.75	0.15	0.80	1.32
	1.25	1	266RG-16MM01A125M	*	*	*	*	*	*	*	*	*	*	*	*	*	*	*	*	*	0.93	0.19	0.80	1.32
	1.25	1	266RG-16MM01C125M	*	*	*	*	*	*	*	*	*	*	*	*	*	*	*	*	*	0.93	0.19	0.80	1.32
	1.25	1	266RG-16MM01F125E	*	*	*	*	*	*	*	*	*	*	*	*	*	*	*	*	*	0.93	0.19	0.80	1.32
	1.50	1	266RG-16MM01A150M	*	*	*	*	*	*	*	*	*	*	*	*	*	*	*	*	*	1.12	0.22	1.00	1.32
	1.50	1	266RG-16MM01C150M	*	*	*	*	*	*	*	*	*	*	*	*	*	*	*	*	*	1.12	0.22	1.00	1.33
	1.50	1	266RG-16MM01F150E	*	*	*	*	*	*	*	*	*	*	*	*	*	*	*	*	*	1.12	0.22	1.00	1.32
	1.75	1	266RG-16MM01A175M	*	*	*	*	*	*	*	*	*	*	*	*	*	*	*	*	*	1.31	0.25	1.20	1.32
	1.75	1	266RG-16MM01C175M	*	*	*	*	*	*	*	*	*	*	*	*	*	*	*	*	*	1.31	0.25	1.20	1.33
	1.75	1	266RG-16MM01F175E	*	*	*	*	*	*	*	*	*	*	*	*	*	*	*	*	*	1.31	0.25	1.20	1.32
	2.00	1	266RG-16MM01A200M	*	*	*	*	*	*	*	*	*	*	*	*	*	*	*	*	*	1.50	0.29	1.40	1.32
	2.00	1	266RG-16MM01C200M	*	*	*	*	*	*	*	*	*	*	*	*	*	*	*	*	*	1.50	0.29	1.40	1.33
	2.00	1	266RG-16MM01F200E	*	*	*	*	*	*	*	*	*	*	*	*	*	*	*	*	*	1.50	0.29	1.40	1.32
	2.50	1	266RG-16MM01A250M	*	*	*	*	*	*	*	*	*	*	*	*	*	*	*	*	*	1.87	0.36	1.40	1.32
	2.50	1	266RG-16MM01C250M	*	*	*	*	*	*	*	*	*	*	*	*	*	*	*	*	*	1.87	0.36	1.40	1.33
	2.50	1	266RG-16MM01F250E	*	*	*	*	*	*	*	*	*	*	*	*	*	*	*	*	*	1.87	0.36	1.40	1.32
	3.00	1	266RG-16MM01A300M	*	*	*	*	*	*	*	*	*	*	*	*	*	*	*	*	*	2.25	0.42	1.80	1.32
	3.00	1	266RG-16MM01C300M	*	*	*	*	*	*	*	*	*	*	*	*	*	*	*	*	*	2.25	0.42	1.80	1.33
	3.00	1	266RG-16MM01F300E	*	*	*	*	*	*	*	*	*	*	*	*	*	*	*	*	*	2.25	0.42	1.80	1.32
22	3.50	1	266RG-22MM01A350M	*	*	*	*	*	*	*	*	*	*	*	*	*	*	*	*	*	2.62	0.49	2.50	1.67
	3.50	1	266RG-22MM01F350E	*	*	*	*	*	*	*	*	*	*	*	*	*	*	*	*	*	2.62	0.49	2.50	1.67
	4.00	1	266RG-22MM01A400M	*	*	*	*	*	*	*	*	*	*	*	*	*	*	*	*	*	3.00	0.56	2.50	1.67
	4.00	1	266RG-22MM01F400E	*	*	*	*	*	*	*	*	*	*	*	*	*	*	*	*	*	3.00	0.56	2.50	1.67
	4.50	1	266RG-22MM01A450M	*	*	*	*	*	*	*	*	*	*	*	*	*	*	*	*	*	3.37	0.63	2.50	1.67
	5.00	1	266RG-22MM01A500M	*	*	*	*	*	*	*	*	*	*	*	*	*	*	*	*	*	3.76	0.71	2.50	1.38
	5.50	1	266RG-22MM01A550M	*	*	*	*	*	*	*	*	*	*	*	*	*	*	*	*	*	4.13	0.79	2.50	1.08
	6.00	1	266RG-22MM01A600M	*	*	*	*	*	*	*	*	*	*	*	*	*	*	*	*	*	4.51	0.86	2.80	0.88

Roscas externas versão direita - pastilha multidentes

TP	NT	Código para pedido	Dimensões, mm																					
			P			M			K			N			S			HA	HB	PDX	PDY			
			1020	1125	1135	1020	1125	1135	1020	1125	1135	1020	1125	1135	1020	1125	1135							
16	1.00	3	266RG-16MM03A100M	*	*	*	*	*	*	*	*	*	*	*	*	*	*	*	*	*	0.75	0.15	2.50	1.62
	1.25	2	266RG-16MM02A125M	*	*	*	*	*	*	*	*	*	*	*	*	*	*	*	*	*	0.96	0.09	2.25	1.41
	1.50	2	266RG-16MM02A150M	*	*	*	*	*	*	*	*	*	*	*	*	*	*	*	*	*	1.12	0.22	2.20	1.42
	1.75	2	266RG-16MM02A175M	*	*	*	*	*	*	*	*	*	*	*	*	*	*	*	*	*	0.93	0.19	1.90	1.33
	2.00	2	266RG-16MM02A200M	*	*	*	*	*	*	*	*	*	*	*	*	*	*	*	*	*	1.50	0.29	2.90	1.91
22	2.50	2	266RG-22MM02A250E	*	*	*	*	*	*	*	*	*	*	*	*	*	*	*	*	*	1.87	0.36	3.75	1.97
	3.00	2	266RG-22MM02A300E	*	*	*	*	*	*	*	*	*	*	*	*	*	*	*	*	*	2.25	0.42	4.40	2.76

R = versão direita



C30



C39



C73



C83



H36



H35



H26



A

Pastilha CoroThread® 266 para torneamento de roscas

Perfil completo 60° métrico

B

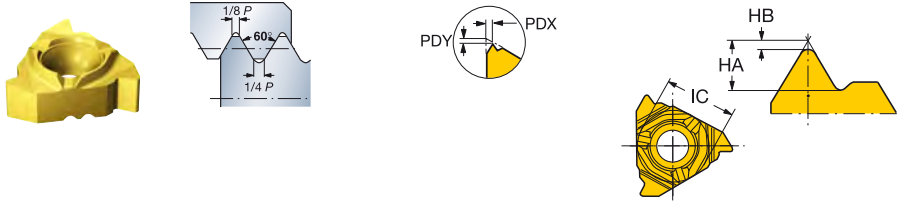

STDNO
TCTR

ISO 965-1998
IT 6

C

Roscas externas versão esquerda

TP	NT	Código para pedido	Dimensões, mm															
			P		M		K		N		S		H		HA	HB	PDX	PDY
			1020	1125	1020	1125	1020	1125	1020	1125	1020	1125	1020	1125				
16	0.50	1	266LG-16MM01A050M	*	*	*	*	*	*	*	*	*	*	☆	0.37	0.08	0.50	1.32
	0.75	1	266LG-16MM01A075M	*	*	*	*	*	*	*	*	*	*	☆	0.56	0.11	0.50	1.32
	1.00	1	266LG-16MM01A100M	*	*	*	*	*	*	*	*	*	*	☆	0.75	0.15	0.80	1.32
	1.25	1	266LG-16MM01A125M	*	*	*	*	*	*	*	*	*	*	☆	0.93	0.19	0.80	1.32
	1.50	1	266LG-16MM01A150M	*	*	*	*	*	*	*	*	*	*	☆	1.12	0.22	1.00	1.32
	1.75	1	266LG-16MM01A175M	*	*	*	*	*	*	*	*	*	*	☆	1.31	0.25	1.20	1.32
	2.00	1	266LG-16MM01A200M	*	*	*	*	*	*	*	*	*	*	☆	1.50	0.29	1.40	1.32
	2.50	1	266LG-16MM01A250M	*	*	*	*	*	*	*	*	*	*	☆	1.87	0.36	1.40	1.32
	3.00	1	266LG-16MM01A300M	*	*	*	*	*	*	*	*	*	*	☆	2.25	0.42	1.80	1.32
22	3.50	1	266LG-22MM01A350M	*	*	*	*	*	*	*	*	*	*	☆	2.62	0.49	2.50	1.67
	4.00	1	266LG-22MM01A400M	*	*	*	*	*	*	*	*	*	*	☆	3.00	0.56	2.50	1.67
	4.50	1	266LG-22MM01A450M	*	*	*	*	*	*	*	*	*	*	☆	3.37	0.63	2.50	1.67
	5.00	1	266LG-22MM01A500M	*	*	*	*	*	*	*	*	*	*	☆	3.76	0.71	2.50	1.38
	5.50	1	266LG-22MM01A550M	*	*	*	*	*	*	*	*	*	*	☆	4.13	0.79	2.50	1.08
	6.00	1	266LG-22MM01A600M	*	*	*	*	*	*	*	*	*	*	☆	4.51	0.86	2.80	0.88

E

L = versão esquerda

F

G

H

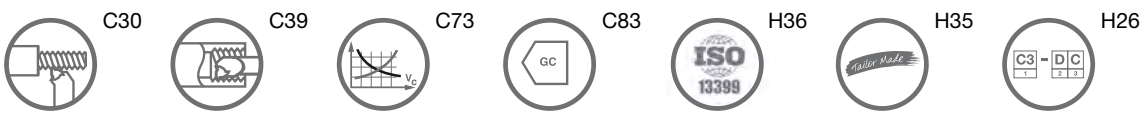

Pastilha CoroThread® 266 para torneamento de roscas

Perfil completo 60° métrico

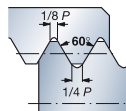

STDNO
TCTR



ISO 965-1998
IT 6

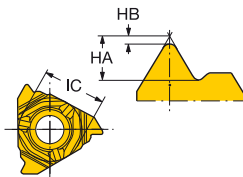

ISO 965-1998
IT 6

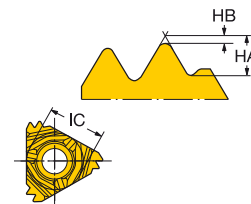

ISO 965-1998
IT 6

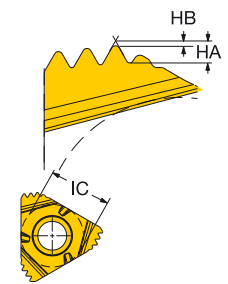

Roscas internas versão direita

TP	NT	Código para pedido	Dimensões, mm																					
			P			M			K			N			S			H			HA	HB	PDX	PDY
			1020	1125	1135	1020	1125	1135	1020	1125	1135	1020	1125	1135	1020	1125	1135	1020	1125	1135				
16	0.50	1	266RL-16MM01A050M	*	*	*	*	*	*	*	*	*	*	*	*	*	*	*	*	*	0.32	0.03	0.50	1.30
	0.75	1	266RL-16MM01A075M	*	*	*	*	*	*	*	*	*	*	*	*	*	*	*	*	*	0.47	0.04	0.50	1.30
	1.00	1	266RL-16MM01A100M	*	*	*	*	*	*	*	*	*	*	*	*	*	*	*	*	*	0.64	0.06	0.80	1.30
	1.00	1	266RL-16MM01C100M	*	*	*	*	*	*	*	*	*	*	*	*	*	*	*	*	*	0.64	0.06	0.80	1.30
	1.00	1	266RL-16MM01F100E	*	*	*	*	*	*	*	*	*	*	*	*	*	*	*	*	*	0.64	0.06	0.80	1.30
	1.25	1	266RL-16MM01A125M	*	*	*	*	*	*	*	*	*	*	*	*	*	*	*	*	*	0.79	0.07	0.80	1.30
	1.25	1	266RL-16MM01C125M	*	*	*	*	*	*	*	*	*	*	*	*	*	*	*	*	*	0.79	0.07	0.80	1.30
	1.25	1	266RL-16MM01F125E	*	*	*	*	*	*	*	*	*	*	*	*	*	*	*	*	*	0.79	0.07	0.80	1.30
	1.50	1	266RL-16MM01A150M	*	*	*	*	*	*	*	*	*	*	*	*	*	*	*	*	*	0.96	0.09	1.00	1.30
	1.50	1	266RL-16MM01C150M	*	*	*	*	*	*	*	*	*	*	*	*	*	*	*	*	*	0.96	0.09	1.50	1.43
	1.50	1	266RL-16MM01F150E	*	*	*	*	*	*	*	*	*	*	*	*	*	*	*	*	*	0.96	0.09	1.00	1.30
	1.75	1	266RL-16MM01A175M	*	*	*	*	*	*	*	*	*	*	*	*	*	*	*	*	*	1.11	0.11	1.20	1.30
	1.75	1	266RL-16MM01C175M	*	*	*	*	*	*	*	*	*	*	*	*	*	*	*	*	*	1.11	0.11	1.20	1.30
	1.75	1	266RL-16MM01F175E	*	*	*	*	*	*	*	*	*	*	*	*	*	*	*	*	*	1.11	0.11	1.20	1.30
	2.00	1	266RL-16MM01A200M	*	*	*	*	*	*	*	*	*	*	*	*	*	*	*	*	*	1.27	0.12	1.40	1.30
	2.00	1	266RL-16MM01C200M	*	*	*	*	*	*	*	*	*	*	*	*	*	*	*	*	*	1.27	0.12	1.40	1.30
	2.00	1	266RL-16MM01F200E	*	*	*	*	*	*	*	*	*	*	*	*	*	*	*	*	*	1.27	0.12	1.40	1.30
	2.50	1	266RL-16MM01A250M	*	*	*	*	*	*	*	*	*	*	*	*	*	*	*	*	*	1.59	0.16	1.40	1.30
	2.50	1	266RL-16MM01C250M	*	*	*	*	*	*	*	*	*	*	*	*	*	*	*	*	*	1.59	0.16	1.40	1.30
	2.50	1	266RL-16MM01F250E	*	*	*	*	*	*	*	*	*	*	*	*	*	*	*	*	*	1.59	0.16	1.40	1.30
	3.00	1	266RL-16MM01A300M	*	*	*	*	*	*	*	*	*	*	*	*	*	*	*	*	*	1.92	0.19	1.80	1.30
	3.00	1	266RL-16MM01C300M	*	*	*	*	*	*	*	*	*	*	*	*	*	*	*	*	*	1.92	0.19	1.80	1.30
	3.00	1	266RL-16MM01F300E	*	*	*	*	*	*	*	*	*	*	*	*	*	*	*	*	*	1.92	0.19	1.80	1.30
22	3.50	1	266RL-22MM01A350M	*	*	*	*	*	*	*	*	*	*	*	*	*	*	*	*	*	2.24	0.26	2.50	1.64
	4.00	1	266RL-22MM01A400M	*	*	*	*	*	*	*	*	*	*	*	*	*	*	*	*	*	2.56	0.30	2.50	1.64
	4.50	1	266RL-22MM01A450M	*	*	*	*	*	*	*	*	*	*	*	*	*	*	*	*	*	2.89	0.33	2.50	1.64
	5.00	1	266RL-22MM01A500M	*	*	*	*	*	*	*	*	*	*	*	*	*	*	*	*	*	3.21	0.38	2.50	1.35
	5.50	1	266RL-22MM01A550M	*	*	*	*	*	*	*	*	*	*	*	*	*	*	*	*	*	3.54	0.40	2.50	1.06
	6.00	1	266RL-22MM01A600M	*	*	*	*	*	*	*	*	*	*	*	*	*	*	*	*	*	3.86	0.47	2.40	0.87

Roscas internas versão direita - pastilha multidentes

TP	NT	Código para pedido	Dimensões, mm																					
			P			M			K			N			S			HA	HB	PDX	PDY			
			1020	1125	1135	1020	1125	1135	1020	1125	1135	1020	1125	1135	1020	1125	1135							
16	1.00	3	266RL-16MM03A100M	*	*	*	*	*	*	*	*	*	*	*	*	*	*	*	*	*	0.64	0.06	2.40	1.59
	1.50	2	266RL-16MM02A150M	*	*	*	*	*	*	*	*	*	*	*	*	*	*	*	*	*	0.96	0.14	2.25	1.41
	2.00	2	266RL-16MM02A200M	*	*	*	*	*	*	*	*	*	*	*	*	*	*	*	*	*	1.27	0.12	2.85	1.79
22	2.50	2	266RL-22MM02A250E	*	*	*	*	*	*	*	*	*	*	*	*	*	*	*	*	*	1.59	0.16	3.50	1.93
	3.00	2	266RL-22MM02A300E	*	*	*	*	*	*	*	*	*	*	*	*	*	*	*	*	*	1.98	0.19	4.40	2.70

R = versão direita



C30



C39

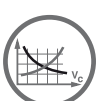

C73



C83



H36



H35

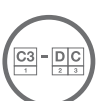

H26

A

Pastilha CoroThread® 266 para torneamento de roscas

Perfil completo 60° métrico

B

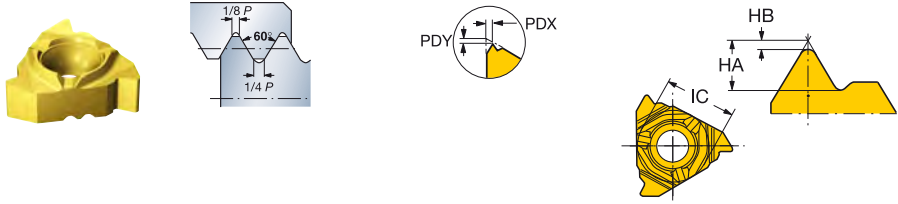

STDNO
TCTR

ISO 965-1998
IT 6

C

Roscas internas versão esquerda

TP	NT	Código para pedido	Dimensões, mm															
			P		M		K		N		S		H		HA	HB	PDX	PDY
			1020	1125	1020	1125	1020	1125	1020	1125	1020	1125	1020	1125				
16	0.50	1	266LL-16MM01A050M	*	*	*	*	*	*	*	*	*	*	☆	0.32	0.03	0.50	1.30
	0.75	1	266LL-16MM01A075M	*	*	*	*	*	*	*	*	*	*	☆	0.47	0.04	0.50	1.30
	1.00	1	266LL-16MM01A100M	*	*	*	*	*	*	*	*	*	*	☆	0.64	0.06	0.80	1.30
	1.25	1	266LL-16MM01A125M	*	*	*	*	*	*	*	*	*	*	☆	0.79	0.07	0.80	1.30
	1.50	1	266LL-16MM01A150M	*	*	*	*	*	*	*	*	*	*	☆	0.96	0.09	1.00	1.30
	1.75	1	266LL-16MM01A175M	*	*	*	*	*	*	*	*	*	*	☆	1.11	0.11	1.20	1.30
	2.00	1	266LL-16MM01A200M	*	*	*	*	*	*	*	*	*	*	☆	1.27	0.12	1.40	1.30
	2.50	1	266LL-16MM01A250M	*	*	*	*	*	*	*	*	*	*	☆	1.59	0.16	1.40	1.30
	3.00	1	266LL-16MM01A300M	*	*	*	*	*	*	*	*	*	*	☆	1.92	0.19	1.80	1.30
22	3.50	1	266LL-22MM01A350M	*	*	*	*	*	*	*	*	*	*	☆	2.24	0.26	2.50	1.64
	4.00	1	266LL-22MM01A400M	*	*	*	*	*	*	*	*	*	*	☆	2.56	0.30	2.50	1.64
	4.50	1	266LL-22MM01A450M	*	*	*	*	*	*	*	*	*	*	☆	2.89	0.33	2.50	1.64
	5.00	1	266LL-22MM01A500M	*	*	*	*	*	*	*	*	*	*	☆	3.21	0.38	2.50	1.35
	5.50	1	266LL-22MM01A550M	*	*	*	*	*	*	*	*	*	*	☆	3.54	0.40	2.50	1.06
	6.00	1	266LL-22MM01A600M	*	*	*	*	*	*	*	*	*	*	☆	3.86	0.47	2.40	0.87

E

L = versão esquerda

F

G

H

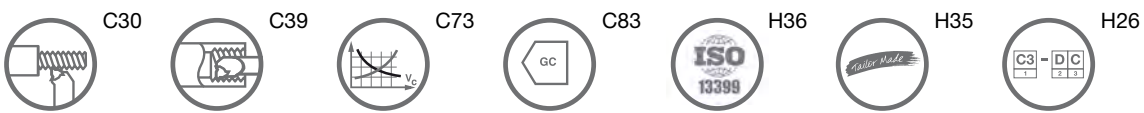

Pastilha CoroThread® 266 para torneamento de roscas

UN 60° Perfil completo

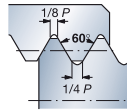

STDNO
TCTR

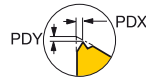

ISO 5864-1978
2A

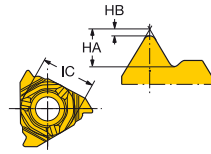

ISO 5864-1978
2A

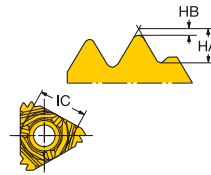

ISO 5864-1978
2A

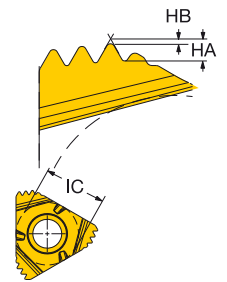

Roscas externas versão direita

TPI	NT	Código para pedido	Dimensões, mm																					
			P			M			K			N			S			H			HA	HB	PDX	PDY
			1020	1125	1135	1020	1125	1135	1020	1125	1135	1020	1125	1135	1020	1125	1135	1020	1125	1135				
16	32.0	1	266RG-16UN01A320M	*	*	*	*	*	*	*	*	*	*	*	*	*	*	*	*	0.59	0.10	0.50	1.30	
28.0	1	266RG-16UN01A280M	*	*	*	*	*	*	*	*	*	*	*	*	*	*	*	*	*	0.68	0.12	0.80	1.32	
24.0	1	266RG-16UN01A240M	*	*	*	*	*	*	*	*	*	*	*	*	*	*	*	*	*	0.79	0.14	0.08	1.30	
24.0	1	266RG-16UN01C240M	*	*	*	*	*	*	*	*	*	*	*	*	*	*	*	*	*	0.79	0.14	0.80	1.33	
24.0	1	266RG-16UN01F240E	*	*	*	*	*	*	*	*	*	*	*	*	*	*	*	*	*	0.79	0.14	0.80	1.30	
20.0	1	266RG-16UN01A200M	*	*	*	*	*	*	*	*	*	*	*	*	*	*	*	*	*	0.95	0.16	0.08	1.30	
20.0	1	266RG-16UN01C200M	*	*	*	*	*	*	*	*	*	*	*	*	*	*	*	*	*	0.95	0.16	0.80	1.33	
20.0	1	266RG-16UN01F200E	*	*	*	*	*	*	*	*	*	*	*	*	*	*	*	*	*	0.95	0.16	0.80	1.30	
18.0	1	266RG-16UN01A180M	*	*	*	*	*	*	*	*	*	*	*	*	*	*	*	*	*	1.05	0.18	1.00	1.30	
18.0	1	266RG-16UN01C180M	*	*	*	*	*	*	*	*	*	*	*	*	*	*	*	*	*	1.05	0.18	1.00	1.33	
18.0	1	266RG-16UN01F180E	*	*	*	*	*	*	*	*	*	*	*	*	*	*	*	*	*	1.05	0.18	1.00	1.30	
16.0	1	266RG-16UN01A160M	*	*	*	*	*	*	*	*	*	*	*	*	*	*	*	*	*	1.19	0.20	1.00	1.30	
16.0	1	266RG-16UN01C160M	*	*	*	*	*	*	*	*	*	*	*	*	*	*	*	*	*	1.19	0.20	1.00	1.33	
16.0	1	266RG-16UN01F160E	*	*	*	*	*	*	*	*	*	*	*	*	*	*	*	*	*	1.19	0.20	1.00	1.30	
14.0	1	266RG-16UN01A140M	*	*	*	*	*	*	*	*	*	*	*	*	*	*	*	*	*	1.35	0.23	1.20	1.30	
14.0	1	266RG-16UN01C140M	*	*	*	*	*	*	*	*	*	*	*	*	*	*	*	*	*	1.35	0.23	1.20	1.33	
14.0	1	266RG-16UN01F140E	*	*	*	*	*	*	*	*	*	*	*	*	*	*	*	*	*	1.35	0.23	1.20	1.30	
13.0	1	266RG-16UN01A130M	*	*	*	*	*	*	*	*	*	*	*	*	*	*	*	*	*	1.46	0.25	1.40	1.30	
12.0	1	266RG-16UN01A120M	*	*	*	*	*	*	*	*	*	*	*	*	*	*	*	*	*	1.58	0.28	1.40	1.30	
12.0	1	266RG-16UN01C120M	*	*	*	*	*	*	*	*	*	*	*	*	*	*	*	*	*	1.58	0.28	1.40	1.33	
12.0	1	266RG-16UN01F120E	*	*	*	*	*	*	*	*	*	*	*	*	*	*	*	*	*	1.58	0.28	1.40	1.30	
11.0	1	266RG-16UN01A110M	*	*	*	*	*	*	*	*	*	*	*	*	*	*	*	*	*	1.72	0.30	1.40	1.30	
10.0	1	266RG-16UN01A100M	*	*	*	*	*	*	*	*	*	*	*	*	*	*	*	*	*	1.90	0.33	1.40	1.30	
9.0	1	266RG-16UN01A090M	*	*	*	*	*	*	*	*	*	*	*	*	*	*	*	*	*	2.11	0.37	1.80	1.30	
8.0	1	266RG-16UN01A080M	*	*	*	*	*	*	*	*	*	*	*	*	*	*	*	*	*	2.38	0.41	1.80	1.30	
8.0	1	266RG-16UN01C080M	*	*	*	*	*	*	*	*	*	*	*	*	*	*	*	*	*	2.38	0.41	1.80	1.33	
8.0	1	266RG-16UN01F080E	*	*	*	*	*	*	*	*	*	*	*	*	*	*	*	*	*	2.38	0.41	1.80	1.30	
22	7.0	1	266RG-22UN01A070M	*	*	*	*	*	*	*	*	*	*	*	*	*	*	*	*	2.70	0.49	2.50	1.67	
6.0	1	266RG-22UN01A060M	*	*	*	*	*	*	*	*	*	*	*	*	*	*	*	*	*	3.16	0.57	2.50	1.67	
5.0	1	266RG-22UN01A050M	*	*	*	*	*	*	*	*	*	*	*	*	*	*	*	*	*	3.81	0.69	2.50	1.38	
4.5	1	266RG-22UN01A045M	*	*	*	*	*	*	*	*	*	*	*	*	*	*	*	*	*	4.23	0.77	2.65	1.08	
4.0	1	266RG-22UN01A040M	*	*	*	*	*	*	*	*	*	*	*	*	*	*	*	*	*	4.76	0.87	2.90	0.79	

Roscas externas versão direita - pastilha multidentes

TPI	NT	Código para pedido	Dimensões, mm																				
			P			M			K			N			S			HA	HB	PDX	PDY		
			1125	1125	1125	1125	1125	1125	1125	1125	1125	1125	1125	1125	1125	1125	1125						
16	18.0	3	266RG-16UN03A180M	*	*	*	*	*	*	*	*	*	*	*	*	*	*	*	*	1.05	0.18	3.45	2.12
16.0	2	266RG-16UN02A160M	*	*	*	*	*	*	*	*	*	*	*	*	*	*	*	*	*	1.19	0.20	2.40	1.52
14.0	2	266RG-16UN02A140M	*	*	*	*	*	*	*	*	*	*	*	*	*	*	*	*	*	1.35	0.23	2.70	1.77
12.0	2	266RG-16UN02A120M	*	*	*	*	*	*	*	*	*	*	*	*	*	*	*	*	*	1.58	0.28	3.10	1.91

R = versão direita



C30



C39

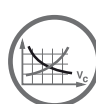

C73



C83



H36



H35



H26

A

TORNEAMENTO DE ROSCAS

Pastilhas

Pastilha CoroThread® 266 para torneamento de roscas

UN 60° Perfil completo

B

Technical drawings of the CoroThread 266 insert. The left drawing shows a 3D perspective view of the insert. The middle drawing shows a cross-section of the insert with dimensions: $1/8 P$, 60° , and $1/4 P$. The right drawing shows a circular cross-section of the insert with dimensions: PDX , PDY , IC , HA , and HB . The standards listed are STDNO TCTR and ISO 5864-1978 2A.

C

Roscas externas versão esquerda

TPI	NT	Código para pedido	Dimensões, mm					HA	HB	PDX	PDY		
			P	M	K	N	S						
16	32.0	1	266LG-16UN01A320M	★	★	★	★	★	★	0.59	0.10	0.50	1.32
28.0	1	266LG-16UN01A280M	★	★	★	★	★	★	★	0.68	0.12	0.80	1.32
24.0	1	266LG-16UN01A240M	★	★	★	★	★	★	★	0.79	0.14	0.80	1.30
20.0	1	266LG-16UN01A200M	★	★	★	★	★	★	★	0.95	0.16	0.80	1.30
18.0	1	266LG-16UN01A180M	★	★	★	★	★	★	★	1.05	0.18	1.00	1.30
16.0	1	266LG-16UN01A160M	★	★	★	★	★	★	★	1.19	0.20	1.00	1.30
14.0	1	266LG-16UN01A140M	★	★	★	★	★	★	★	1.35	0.23	1.20	1.30
13.0	1	266LG-16UN01A130M	★	★	★	★	★	★	★	1.46	0.25	1.40	1.32
12.0	1	266LG-16UN01A120M	★	★	★	★	★	★	★	1.58	0.28	1.40	1.30
11.0	1	266LG-16UN01A110M	★	★	★	★	★	★	★	1.72	0.30	1.40	1.30
10.0	1	266LG-16UN01A100M	★	★	★	★	★	★	★	1.90	0.33	1.40	1.30
9.0	1	266LG-16UN01A090M	★	★	★	★	★	★	★	2.11	0.37	1.80	1.32
8.0	1	266LG-16UN01A080M	★	★	★	★	★	★	★	2.38	0.41	1.80	1.30

L = versão esquerda

E

F

G

H

Logos for various standards and certifications: C30, C39, C73, C83, H36, H35, H26.

C 12

SANDVIK
Coromant

Pastilha CoroThread® 266 para torneamento de roscas

UN 60° Perfil completo

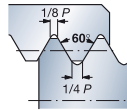

STDNO
TCTR

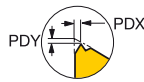

ISO 5864-1978
2B

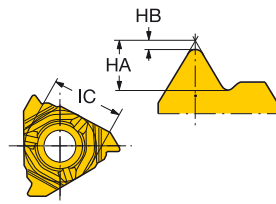

ISO 5864-1978
2B

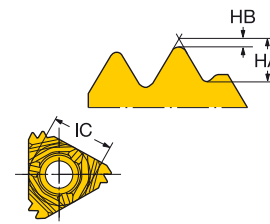

Roscas internas versão direita

TPI	NT	Código para pedido	Dimensões, mm																						
			P			M			K			N			S			H			HA	HB	PDX	PDY	
			1020	1125	1135	1020	1125	1135	1020	1125	1135	1020	1125	1135	1020	1125	1135	1020	1125	1135					
16	32.0	1	266RL-16UN01A320M	*	*	*	*	*	*	*	*	*	*	*	*	*	*	*	*	*	*	0.50	0.05	0.90	1.30
	28.0	1	266RL-16UN01A280M	*	*	*	*	*	*	*	*	*	*	*	*	*	*	*	*	*	*	0.77	0.14	0.80	1.32
	24.0	1	266RL-16UN01A240M	*	*	*	*	*	*	*	*	*	*	*	*	*	*	*	*	*	*	0.67	0.06	1.30	1.35
	20.0	1	266RL-16UN01A200M	*	*	*	*	*	*	*	*	*	*	*	*	*	*	*	*	*	*	0.80	0.07	0.80	1.30
	20.0	1	266RL-16UN01C200M	*	*	*	*	*	*	*	*	*	*	*	*	*	*	*	*	*	*	0.80	0.07	0.80	1.30
	18.0	1	266RL-16UN01A180M	*	*	*	*	*	*	*	*	*	*	*	*	*	*	*	*	*	*	0.89	0.08	1.00	1.30
	18.0	1	266RL-16UN01C180M	*	*	*	*	*	*	*	*	*	*	*	*	*	*	*	*	*	*	0.89	0.08	1.00	1.30
	16.0	1	266RL-16UN01A160M	*	*	*	*	*	*	*	*	*	*	*	*	*	*	*	*	*	*	1.00	0.09	1.00	1.30
	16.0	1	266RL-16UN01C160M	*	*	*	*	*	*	*	*	*	*	*	*	*	*	*	*	*	*	1.00	0.09	1.00	1.30
	16.0	1	266RL-16UN01F160E	*	*	*	*	*	*	*	*	*	*	*	*	*	*	*	*	*	*	1.00	0.09	1.00	1.30
	14.0	1	266RL-16UN01A140M	*	*	*	*	*	*	*	*	*	*	*	*	*	*	*	*	*	*	1.13	0.11	1.20	1.30
	14.0	1	266RL-16UN01C140M	*	*	*	*	*	*	*	*	*	*	*	*	*	*	*	*	*	*	1.13	0.11	1.20	1.30
	12.0	1	266RL-16UN01A120M	*	*	*	*	*	*	*	*	*	*	*	*	*	*	*	*	*	*	1.33	0.13	1.40	1.30
	12.0	1	266RL-16UN01C120M	*	*	*	*	*	*	*	*	*	*	*	*	*	*	*	*	*	*	1.33	0.13	1.40	1.30
	12.0	1	266RL-16UN01F120E	*	*	*	*	*	*	*	*	*	*	*	*	*	*	*	*	*	*	1.33	0.13	1.40	1.30
	11.0	1	266RL-16UN01A110M	*	*	*	*	*	*	*	*	*	*	*	*	*	*	*	*	*	*	1.45	0.14	1.40	1.30
	10.0	1	266RL-16UN01A100M	*	*	*	*	*	*	*	*	*	*	*	*	*	*	*	*	*	*	1.59	0.16	1.40	1.30
	9.0	1	266RL-16UN01A090M	*	*	*	*	*	*	*	*	*	*	*	*	*	*	*	*	*	*	1.77	0.18	1.80	1.30
	8.0	1	266RL-16UN01A080M	*	*	*	*	*	*	*	*	*	*	*	*	*	*	*	*	*	*	2.00	0.20	1.80	1.30
	8.0	1	266RL-16UN01C080M	*	*	*	*	*	*	*	*	*	*	*	*	*	*	*	*	*	*	2.00	0.20	1.80	1.30
22	7.0	1	266RL-22UN01A070M	*	*	*	*	*	*	*	*	*	*	*	*	*	*	*	*	*	*	2.31	0.26	2.50	1.64
	6.0	1	266RL-22UN01A060M	*	*	*	*	*	*	*	*	*	*	*	*	*	*	*	*	*	*	2.70	0.32	2.50	1.64
	5.0	1	266RL-22UN01A050M	*	*	*	*	*	*	*	*	*	*	*	*	*	*	*	*	*	*	3.25	0.38	2.50	1.35
	4.5	1	266RL-22UN01A045M	*	*	*	*	*	*	*	*	*	*	*	*	*	*	*	*	*	*	3.62	0.41	2.50	1.06
	4.0	1	266RL-22UN01A040M	*	*	*	*	*	*	*	*	*	*	*	*	*	*	*	*	*	*	4.08	0.49	2.60	0.96

Roscas internas versão direita - pastilha multidentes

TPI	NT	Código para pedido	Dimensões, mm														
			P		M		K		N		S		HA	HB	PDX	PDY	
			1125	1125	1125	1125	1125	1125	1125	1125	1125	1125					
16	16.0	2	266RL-16UN02A160M	*	*	*	*	*	*	*	*	*	*	1.00	0.09	0.80	1.30
	12.0	2	266RL-16UN02A120M	*	*	*	*	*	*	*	*	*	*	1.33	0.13	2.95	1.88

R = versão direita



C30



C39



C73



C83



H36



H35



H26

A

TORNEAMENTO DE ROSCAS

Pastilhas

Pastilha CoroThread® 266 para torneamento de roscas

UN 60° Perfil completo

B

STDNO
TCTRISO 5864-1978
2B

C

Roscas internas versão esquerda

TPI	NT	Código para pedido	P	M	K	N	S	H	Dimensões, mm			
			11/25	11/25	11/25	11/25	11/25	11/25	HA	HB	PDX	PDY
16	20.0	1	★	★	★	★	★	☆	0.80	0.07	0.80	1.30
18.0	1	266LL-16UN01A180M	★	★	★	★	★	☆	0.89	0.08	1.00	1.30
16.0	1	266LL-16UN01A160M	★	★	★	★	★	☆	1.00	0.09	1.00	1.30
14.0	1	266LL-16UN01A140M	★	★	★	★	★	☆	1.13	0.11	1.20	1.30
12.0	1	266LL-16UN01A120M	★	★	★	★	★	☆	1.33	0.13	1.40	1.30
11.0	1	266LL-16UN01A110M	★	★	★	★	★	☆	1.45	0.14	1.40	1.30
10.0	1	266LL-16UN01A100M	★	★	★	★	★	☆	1.59	0.16	1.40	1.30
9.0	1	266LL-16UN01A090M	★	★	★	★	★	☆	1.77	0.18	1.80	1.30
8.0	1	266LL-16UN01A080M	★	★	★	★	★	☆	2.00	0.20	1.80	1.30

L = versão esquerda

E

F

G

H

C30

C39

C73

C83

H36

H35

H26

C 14

Pastilha CoroThread® 266 para torneamento de roscas

Whitworth 55° (BSW, BSF, BSP) Perfil completo

STDNO
STDNO
STDNO
TCTR

ISO 228-1982
BS-2779-1973
BS-84-1957
A

ISO 228-1982
BS-2779-1973
BS-84-1957
A

ISO 228-1982
BS-2779-1973
BS-84-1957
A

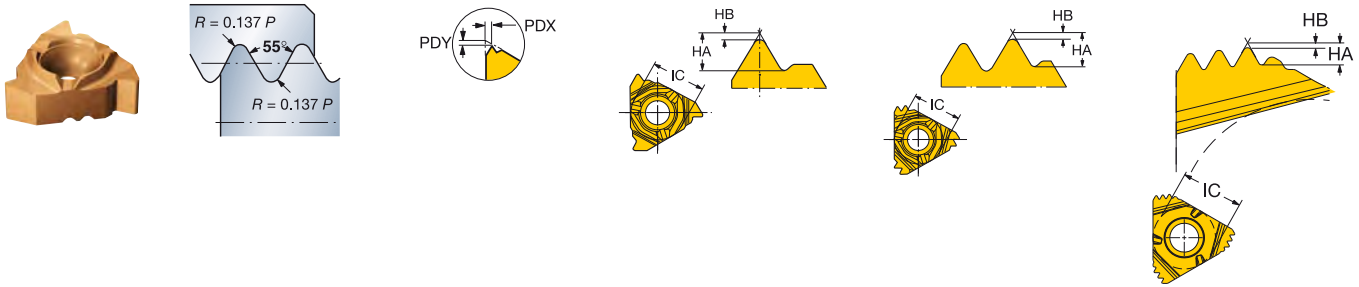

Roscas externas versão direita

TPI	NT	Código para pedido	Dimensões, mm																					
			P			M			K			N			S			H						
			1020	1125	1135	1020	1125	1135	1020	1125	1135	1020	1125	1135	1020	1125	1135	1020	1125	1135	HA	HB	PDX	PDY
16	28.0	1	266RG-16WH01A280M	*	*	*	*	*	*	*	*	*	*	*	*	*	*	*	*	*	0.72	0.13	0.80	1.32
26.0	1	266RG-16WH01A260M	*	*	*	*	*	*	*	*	*	*	*	*	*	*	*	*	*	*	0.77	0.14	2.30	1.51
20.0	1	266RG-16WH01A200M	*	*	*	*	*	*	*	*	*	*	*	*	*	*	*	*	*	*	1.01	0.18	0.80	1.32
19.0	1	266RG-16WH01A190M	*	*	*	*	*	*	*	*	*	*	*	*	*	*	*	*	*	*	1.06	0.19	0.80	1.32
19.0	1	266RG-16WH01C190M	*	*	*	*	*	*	*	*	*	*	*	*	*	*	*	*	*	*	1.06	0.19	0.80	1.33
19.0	1	266RG-16WH01F190E	*	*	*	*	*	*	*	*	*	*	*	*	*	*	*	*	*	*	1.06	0.19	0.80	1.32
18.0	1	266RG-16WH01A180M	*	*	*	*	*	*	*	*	*	*	*	*	*	*	*	*	*	*	1.12	0.20	1.00	1.32
16.0	1	266RG-16WH01A160M	*	*	*	*	*	*	*	*	*	*	*	*	*	*	*	*	*	*	1.26	0.23	1.00	1.32
14.0	1	266RG-16WH01A140M	*	*	*	*	*	*	*	*	*	*	*	*	*	*	*	*	*	*	1.44	0.26	1.20	1.32
14.0	1	266RG-16WH01C140M	*	*	*	*	*	*	*	*	*	*	*	*	*	*	*	*	*	*	1.44	0.26	1.20	1.33
14.0	1	266RG-16WH01F140E	*	*	*	*	*	*	*	*	*	*	*	*	*	*	*	*	*	*	1.44	0.26	1.20	1.32
12.0	1	266RG-16WH01A120M	*	*	*	*	*	*	*	*	*	*	*	*	*	*	*	*	*	*	1.68	0.31	1.40	1.32
11.0	1	266RG-16WH01A110M	*	*	*	*	*	*	*	*	*	*	*	*	*	*	*	*	*	*	1.83	0.34	1.40	1.32
11.0	1	266RG-16WH01C110M	*	*	*	*	*	*	*	*	*	*	*	*	*	*	*	*	*	*	1.83	0.34	1.40	1.33
11.0	1	266RG-16WH01F110E	*	*	*	*	*	*	*	*	*	*	*	*	*	*	*	*	*	*	1.83	0.34	1.40	1.32
10.0	1	266RG-16WH01A100M	*	*	*	*	*	*	*	*	*	*	*	*	*	*	*	*	*	*	2.02	0.37	1.40	1.32
9.0	1	266RG-16WH01A090M	*	*	*	*	*	*	*	*	*	*	*	*	*	*	*	*	*	*	2.24	0.42	1.80	1.32
8.0	1	266RG-16WH01A080M	*	*	*	*	*	*	*	*	*	*	*	*	*	*	*	*	*	*	2.52	0.47	1.80	1.32
22	7.0	1	266RG-22WH01A070M	*	*	*	*	*	*	*	*	*	*	*	*	*	*	*	*	*	2.88	0.54	2.50	1.67
6.0	1	266RG-22WH01A060M	*	*	*	*	*	*	*	*	*	*	*	*	*	*	*	*	*	*	3.37	0.64	2.50	1.67
5.0	1	266RG-22WH01A050M	*	*	*	*	*	*	*	*	*	*	*	*	*	*	*	*	*	*	4.04	0.77	2.50	1.38
4.5	1	266RG-22WH01A045M	*	*	*	*	*	*	*	*	*	*	*	*	*	*	*	*	*	*	4.49	0.85	2.65	0.98
4.0	1	266RG-22WH01A040M	*	*	*	*	*	*	*	*	*	*	*	*	*	*	*	*	*	*	5.06	0.96	2.75	0.59

Roscas externas versão direita - pastilha multidentes

TPI	NT	Código para pedido	Dimensões, mm																					
			P			M			K			N			S			HA	HB	PDX	PDY			
			1020	1125	1135	1020	1125	1135	1020	1125	1135	1020	1125	1135	1020	1125	1135							
16	19.0	3	266RG-16WH03A190M	*	*	*	*	*	*	*	*	*	*	*	*	*	*	*	*	*	1.06	0.19	3.30	2.02
14.0	2	266RG-16WH02A140M	*	*	*	*	*	*	*	*	*	*	*	*	*	*	*	*	*	*	1.44	0.26	2.70	1.73
22	11.0	2	266RG-22WH02A110E	*	*	*	*	*	*	*	*	*	*	*	*	*	*	*	*	*	1.83	0.34	3.40	1.87

Roscas externas versão esquerda

TPI	NT	Código para pedido	Dimensões, mm																					
			P			M			K			N			S			HA	HB	PDX	PDY			
			1125	1125	1125	1125	1125	1125	1125	1125	1125	1125	1125	1125	1125	1125								
16	19.0	1	266LG-16WH01A190M	*	*	*	*	*	*	*	*	*	*	*	*	*	*	*	*	*	1.06	0.19	0.80	1.32
14.0	1	266LG-16WH01A140M	*	*	*	*	*	*	*	*	*	*	*	*	*	*	*	*	*	*	1.44	0.26	1.20	1.32
11.0	1	266LG-16WH01A110M	*	*	*	*	*	*	*	*	*	*	*	*	*	*	*	*	*	*	1.83	0.34	1.40	1.32

R = versão direita, L = versão esquerda



Pastilha CoroThread® 266 para torneamento de roscas

Whitworth 55° (BSW, BSF, BSP) Perfil completo

STDNO
STDNO
STDNO
TCTR

ISO 228-1982
BS-2779-1973
BS-84-1957
A

ISO 228-1982
BS-2779-1973
BS-84-1957
A

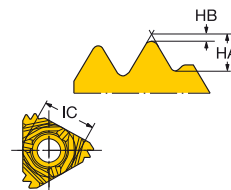
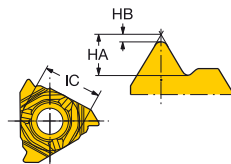
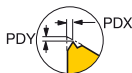
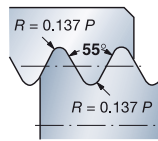

Roscas internas versão direita

TPI	NT	Código para pedido	P		M		K		N		S		H		Dimensões, mm					
			1020	1125	1135	1020	1125	1135	1020	1125	1135	1020	1125	1135	1020	1125	1135	HA	HB	PDX
16	26.0	1	266RL-16WH01A260M	*			*		*		*		*	☆			0.78	0.14	0.80	1.30
20.0	1	266RL-16WH01A200M	*	*		*	*	*	*	*	*	*	*	☆			0.99	0.17	0.80	1.30
19.0	1	266RL-16WH01A190M	*	☆		*	*	*	*	*	*	*	*	☆	☆		1.05	0.18	0.80	1.30
18.0	1	266RL-16WH01A180M	*	*		*	*	*	*	*	*	*	*	☆			1.97	1.00	1.00	1.30
16.0	1	266RL-16WH01A160M	*	*		*	*	*	*	*	*	*	*	☆			1.25	0.22	1.00	1.30
14.0	1	266RL-16WH01A140M	*	☆		*	*	*	*	*	*	*	*	☆			1.43	0.25	1.20	1.30
14.0	1	266RL-16WH01C140M	*	*		*	*	*	*	*	*	*	*	☆			1.43	0.25	1.20	1.30
14.0	1	266RL-16WH01F140E	*	*		*	*	*	*	*	*	*	*	☆			1.43	0.25	1.20	1.30
12.0	1	266RL-16WH01A120M	*	*		*	*	*	*	*	*	*	*	☆			1.67	0.30	1.40	1.30
11.0	1	266RL-16WH01A110M	*	☆		*	*	*	*	*	*	*	*	☆			1.83	0.33	1.40	1.30
11.0	1	266RL-16WH01C110M	*	*		*	*	*	*	*	*	*	*	☆			1.83	0.33	1.40	1.30
11.0	1	266RL-16WH01F110E	*	*		*	*	*	*	*	*	*	*	☆			1.83	0.33	1.40	1.30
10.0	1	266RL-16WH01A100M	*	*		*	*	*	*	*	*	*	*	☆			2.02	0.37	1.40	1.30
9.0	1	266RL-16WH01A090M	*	*		*	*	*	*	*	*	*	*	☆			2.24	0.41	1.80	1.30
8.0	1	266RL-16WH01A080M	*	☆		*	*	*	*	*	*	*	*	☆			2.53	0.47	1.80	1.30
22	7.0	1	266RL-22WH01A070M	*		*	*	*	*	*	*	*	*	☆			2.88	0.53	2.50	1.64
6.0	1	266RL-22WH01A060M	*	*		*	*	*	*	*	*	*	*	☆			3.36	0.62	2.50	1.64
5.0	1	266RL-22WH01A050M	*	*		*	*	*	*	*	*	*	*	☆			4.03	0.76	2.50	1.35
4.5	1	266RL-22WH01A045M	*	*		*	*	*	*	*	*	*	*	☆			4.48	0.85	2.65	0.96
4.0	1	266RL-22WH01A040M	*	*		*	*	*	*	*	*	*	*	☆			5.04	0.96	2.75	0.67

Roscas internas versão direita - pastilha multidentes

TPI	NT	Código para pedido	P		M		K		N		S		Dimensões, mm				
			1020	1125	1125	1020	1125	1020	1125	HA	HB	PDX	PDY				
16	14.0	2	266RL-16WH02A140M	*	*	*	*	*	*	*	*	*	*	1.43	0.25	2.70	1.69
22	11.0	2	266RL-22WH02A110E	*	*	*	*	*	*	*	*	*	*	1.83	0.33	3.40	1.83

Roscas internas versão esquerda

TPI	NT	Código para pedido	P		M		K		N		S		H		Dimensões, mm			
			1125	1125	1125	1125	1125	1125	HA	HB	PDX	PDY						
16	14.0	1	266LL-16WH01A140M	*	*	*	*	*	*	*	*	*	*	1.43	0.25	1.20	1.30	
11.0	1	266LL-16WH01A110M	*	*	*	*	*	*	*	*	*	*	*	1.83	0.33	1.40	1.30	

R = versão direita, L = versão esquerda



C30



C39



C73



C83



H36



H35



H26

Pastilha CoroThread® 266 para torneamento de roscas

NPT 60° (NPSC, NPTR, LINE PIPE) perfil completo

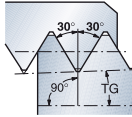

STDNO

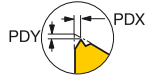

ANSI B.1.20.1-1983

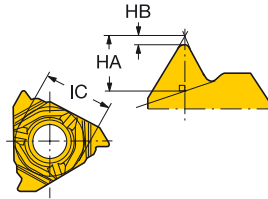

ANSI B.1.20.1-1983

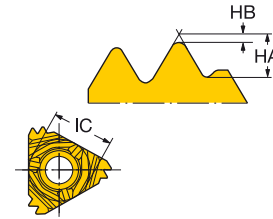

Roscas externas versão direita

TPI	NT	Código para pedido	Dimensões, mm						HA	HB	PDX	PDY	TG				
			P	M	K	N	S	H									
16	27.0	1	266RG-16NT01A270M	☆	☆	☆	☆	☆	☆	☆	☆	☆	0.76	0.05	0.80	1.03	0.03
	18.0	1	266RG-16NT01A180M	☆	☆	☆	☆	☆	☆	☆	☆	☆	1.14	0.08	1.00	1.03	0.03
	14.0	1	266RG-16NT01A140M	☆	☆	☆	☆	☆	☆	☆	☆	☆	1.46	0.09	1.20	1.03	0.03
	14.0	1	266RG-16NT01C140M	☆	☆	☆	☆	☆	☆	☆	☆	☆	1.46	0.09	1.20	1.03	0.03
	14.0	1	266RG-16NT01F140E	☆	☆	☆	☆	☆	☆	☆	☆	☆	1.46	0.09	1.20	1.03	0.03
	11.5	1	266RG-16NT01A115M	☆	☆	☆	☆	☆	☆	☆	☆	☆	1.79	0.11	1.40	1.03	0.03
	11.5	1	266RG-16NT01C115M	☆	☆	☆	☆	☆	☆	☆	☆	☆	1.79	0.11	1.40	1.03	0.03
	11.5	1	266RG-16NT01F115E	☆	☆	☆	☆	☆	☆	☆	☆	☆	1.79	0.11	1.40	1.03	0.03
	8.0	1	266RG-16NT01A080M	☆	☆	☆	☆	☆	☆	☆	☆	☆	2.57	0.14	1.60	1.03	0.03
	8.0	1	266RG-16NT01C080M	☆	☆	☆	☆	☆	☆	☆	☆	☆	2.57	0.14	1.60	1.03	0.03

Roscas externas versão direita - pastilha multidentes

TPI	NT	Código para pedido	Dimensões, mm					HA	HB	PDX	PDY	TG					
			P	M	K	N	S										
22	11.5	2	266RG-22NT02A115E	☆	☆	☆	☆	☆	☆	☆	☆	☆	1.79	0.11	3.40	1.67	0.03

Roscas externas versão esquerda

TPI	NT	Código para pedido	Dimensões, mm					HA	HB	PDX	PDY	TG					
			P	M	K	N	S										
16	27.0	1	266LG-16NT01A270M	☆	☆	☆	☆	☆	☆	☆	☆	☆	0.76	0.05	0.80	1.03	0.03
	18.0	1	266LG-16NT01A180M	☆	☆	☆	☆	☆	☆	☆	☆	☆	1.14	0.08	1.00	1.03	0.03
	14.0	1	266LG-16NT01A140M	☆	☆	☆	☆	☆	☆	☆	☆	☆	1.46	0.09	1.20	1.03	0.03
	11.5	1	266LG-16NT01A115M	☆	☆	☆	☆	☆	☆	☆	☆	☆	1.79	0.11	1.40	1.03	0.03
	8.0	1	266LG-16NT01A080M	☆	☆	☆	☆	☆	☆	☆	☆	☆	2.57	0.14	1.60	1.03	0.03

R = versão direita, L = versão esquerda



C30



C39

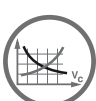

C73



C83



H36



H35

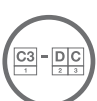

H26



Pastilha CoroThread® 266 para torneamento de roscas

NPT 60° (NPSC, NPTR, LINE PIPE) perfil completo

B

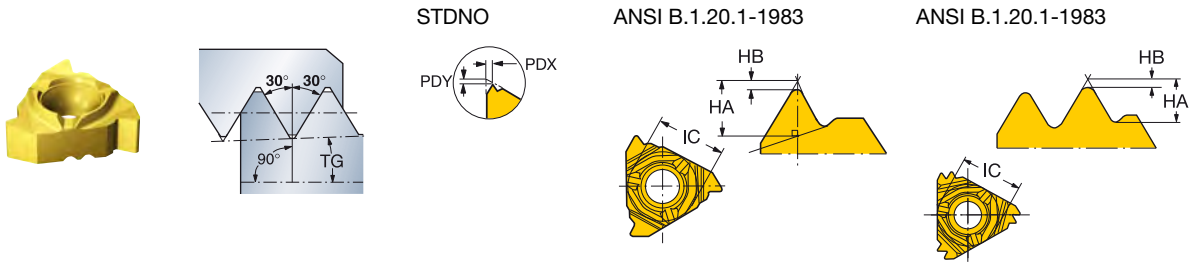

C

Roscas internas versão direita

TPI	NT	Código para pedido	Dimensões, mm													
			P	M	K	N	S	H								
16	14.0	1	1125	1135	1125	1135	1125	1135	1125	1135	HA	HB	PDX	PDY	TG	
		266RL-16NT01A140M	★	☆	☆	★	★	☆	★	☆	★	1.46	0.09	1.20	1.01	0.03
		266RL-16NT01C140M	★	★	★	★	★	★	★	★	★	1.46	0.09	1.20	1.01	0.03
		266RL-16NT01F140E	★	★	★	★	★	★	★	★	★	1.46	0.09	1.20	1.01	0.03
		266RL-16NT01A115M	★	☆	☆	★	★	☆	★	★	★	1.78	0.11	1.40	1.01	0.03
		266RL-16NT01C115M	★	★	★	★	★	★	★	★	★	1.78	0.11	1.40	1.01	0.03
		266RL-16NT01F115E	★	★	★	★	★	★	★	★	★	1.78	0.11	1.40	1.01	0.03
		266RL-16NT01A080M	★	☆	☆	★	★	☆	★	★	★	2.57	0.14	1.60	1.01	0.03
		266RL-16NT01C080M	★	★	★	★	★	★	★	★	★	2.57	0.14	1.60	1.01	0.03

D

Roscas internas versão direita - pastilha multidentes

TPI	NT	Código para pedido	Dimensões, mm									
			P	M	K	N	S					
22	11.5	2	1020	1020	1020	1020	1020	HA	HB	PDX	PDY	TG
		266RL-22NT02A115E	★	★	★	★	★	1.79	0.11	3.40	1.64	0.03

E

Roscas internas versão esquerda

TPI	NT	Código para pedido	Dimensões, mm										
			P	M	K	N	S	H					
16	14.0	1	1125	1125	1125	1125	1125	HA	HB	PDX	PDY	TG	
		266LL-16NT01A140M	★	★	★	★	★	★	1.46	0.09	1.20	1.01	0.03
		266LL-16NT01A115M	★	★	★	★	★	★	1.79	0.11	1.40	1.01	0.03
		266LL-16NT01A080M	★	★	★	★	★	★	2.57	0.14	1.60	1.01	0.03

F

R = versão direita, L = versão esquerda

G

H

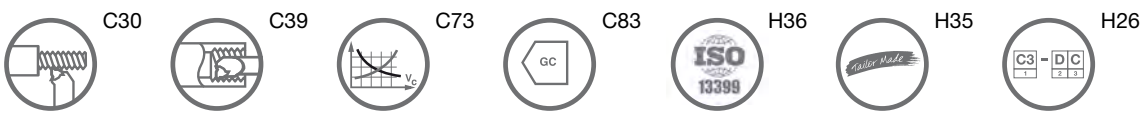

Pastilha CoroThread® 266 para torneamento de roscas

BSPT 55° Perfil completo

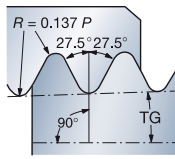

STDNO
STDNO

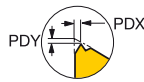

ISO 7/1
BS21:1985

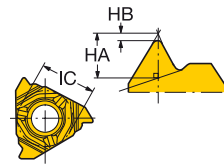

Roscas externas versão direita

TPI	NT	Código para pedido	Dimensões, mm												
			P	M	K	N	S	H							
16	28.0	1 266RG-16PT01A280E	★	★	★	★	★	★	★	★	HA	HB	PDX	PDY	TG
19.0	1	266RG-16PT01A190E	★	★	★	★	★	★	★	★	1.04	0.19	0.80	1.32	0.03
14.0	1	266RG-16PT01A140E	★	★	★	★	★	★	★	★	1.41	0.26	1.20	1.32	0.03
11.0	1	266RG-16PT01A110E	★	★	★	★	★	★	★	★	1.80	0.34	1.40	1.32	0.03
8.0	1	266RG-16PT01A080E	★	★	★	★	★	★	★	★	2.47	0.47	1.80	1.32	0.03

Roscas externas versão esquerda

TPI	NT	Código para pedido	Dimensões, mm												
			P	M	K	N	S	H							
16	19.0	1 266LG-16PT01A190E	★	★	★	★	★	★	★	★	HA	HB	PDX	PDY	TG
14.0	1	266LG-16PT01A140E	★	★	★	★	★	★	★	★	1.41	0.26	1.20	1.32	0.03
11.0	1	266LG-16PT01A110E	★	★	★	★	★	★	★	★	1.80	0.34	1.40	1.32	0.03

Roscas internas versão direita

TPI	NT	Código para pedido	Dimensões, mm												
			P	M	K	N	S	H							
16	28.0	1 266RL-16PT01A280E	★	★	★	★	★	★	★	★	HA	HB	PDX	PDY	TG
19.0	1	266RL-16PT01A190E	★	★	★	★	★	★	★	★	1.03	0.18	0.80	1.30	0.03
14.0	1	266RL-16PT01A140E	★	★	★	★	★	★	★	★	1.40	0.25	1.20	1.30	0.03
11.0	1	266RL-16PT01A110E	★	★	★	★	★	★	★	★	1.80	0.33	1.40	1.30	0.03
8.0	1	266RL-16PT01A080E	★	★	★	★	★	★	★	★	2.48	0.47	1.80	1.30	0.03

Roscas internas versão esquerda

TPI	NT	Código para pedido	Dimensões, mm												
			P	M	K	N	S	H							
16	19.0	1 266LL-16PT01A190E	★	★	★	★	★	★	★	★	HA	HB	PDX	PDY	TG
14.0	1	266LL-16PT01A140E	★	★	★	★	★	★	★	★	1.40	0.25	1.20	1.30	0.03
11.0	1	266LL-16PT01A110E	★	★	★	★	★	★	★	★	1.80	0.33	1.40	1.30	0.03

R = versão direita, L = versão esquerda



C30



C39



C73



C83



H36



H35



H26



A

TORNEAMENTO DE ROSCAS

Pastilhas

Pastilha CoroThread® 266 para torneamento de roscas

NPTF 60° Perfil completo

STDNO
TCTRANSI B1.20.3-1976
IT 2

B

C

Roscas externas versão direita

			P	M	K	N	S	H	Dimensões, mm				
	NT	Código para pedido	1125	1125	1125	1125	1125	1125	HA	HB	PDX	PDY	TG
16	27.0	1	★	★	★	★	★	☆	0.75	0.11	0.80	1.03	0.03
	18.0	1	★	★	★	★	★	☆	1.14	0.13	1.00	1.03	0.03
	14.0	1	★	★	★	★	★	☆	1.49	0.13	1.20	1.03	0.03
	11.5	1	★	★	★	★	★	☆	1.81	0.17	1.40	1.03	0.03
	8.0	1	★	★	★	★	★	☆	2.60	0.21	1.60	1.03	0.03

D

Roscas internas versão direita

			P	M	K	N	S	H	Dimensões, mm				
	NT	Código para pedido	1125	1125	1125	1125	1125	1125	HA	HB	PDX	PDY	TG
16	14.0	1	★	★	★	★	★	☆	1.49	0.13	1.20	1.01	0.03
	11.5	1	★	★	★	★	★	☆	1.81	0.17	1.40	1.01	0.03
	8.0	1	★	★	★	★	★	☆	2.60	0.21	1.60	1.01	0.03

R = versão direita

F

G

H

C30

C39

C73

C83

H36

H35

H26

C 20

Pastilha CoroThread® 266 para torneamento de roscas

Redonda 30° Perfil completo

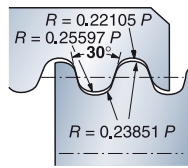

STDNO
TCTR

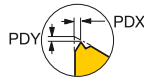

DIN 405
IT 7-6

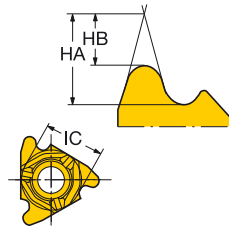

Roscas externas versão direita

TPI	NT	Código para pedido	P		M		K		N		S		H		Dimensões, mm					
			1020	1125	1020	1125	1020	1125	1020	1125	1020	1125	1020	1125	1020	1125	HA	HB	PDX	PDY
			*	*	*	*	*	*	*	*	*	*	*	*	*	*	*	*	*	*
16	10.0	1	266RG-16RN01A100M	*	*	*	*	*	*	*	*	*	*	*	*	2.97	1.72	0.85	1.33	
8.0	1	266RG-16RN01A080M	*	*	*	*	*	*	*	*	*	*	*	*	*	3.72	2.14	1.05	1.38	
8.0	1	266RG-16RN01F080E	*	*	*	*	*	*	*	*	*	*	*	*	*	3.72	2.14	1.05	1.37	
6.0	1	266RG-16RN01A060M	*	*	*	*	*	*	*	*	*	*	*	*	*	4.98	2.86	1.50	1.43	
6.0	1	266RG-16RN01F060E	*	*	*	*	*	*	*	*	*	*	*	*	*	4.98	2.86	1.50	1.43	
22	4.0	1	266RG-22RN01A040M	*	*	*	*	*	*	*	*	*	*	*	*	7.45	4.30	2.60	1.38	
4.0	1	266RG-22RN01F040E	*	*	*	*	*	*	*	*	*	*	*	*	*	7.45	4.30	2.60	1.38	

Roscas externas versão esquerda

TPI	NT	Código para pedido	P		M		K		N		S		H		Dimensões, mm			
			1020	1125	1020	1125	1020	1125	1020	1125	1020	1125	1020	1125	HA	HB	PDX	PDY
			*	*	*	*	*	*	*	*	*	*	*	*	*	*	*	*
16	10.0	1	266LG-16RN01A100M	*	*	*	*	*	*	*	*	*	*	*	2.97	1.72	0.85	1.32
8.0	1	266LG-16RN01A080M	*	*	*	*	*	*	*	*	*	*	*	*	3.72	2.14	1.05	1.32
6.0	1	266LG-16RN01A060M	*	*	*	*	*	*	*	*	*	*	*	*	4.98	2.86	1.50	1.43
22	4.0	1	266LG-22RN01A040M	*	*	*	*	*	*	*	*	*	*	*	7.45	4.30	2.60	1.38

Roscas internas versão direita

TPI	NT	Código para pedido	P		M		K		N		S		H		Dimensões, mm			
			1020	1125	1020	1125	1020	1125	1020	1125	1020	1125	1020	1125	HA	HB	PDX	PDY
			*	*	*	*	*	*	*	*	*	*	*	*	*	*	*	*
16	10.0	1	266RL-16RN01A100M	*	*	*	*	*	*	*	*	*	*	*	2.87	1.58	0.85	1.30
8.0	1	266RL-16RN01A080M	*	*	*	*	*	*	*	*	*	*	*	*	3.56	1.97	1.05	1.30
6.0	1	266RL-16RN01A060M	*	*	*	*	*	*	*	*	*	*	*	*	4.79	2.66	1.35	1.50
6.0	1	266RL-16RN01F060E	*	*	*	*	*	*	*	*	*	*	*	*	4.79	2.66	1.35	1.45
22	4.0	1	266RL-22RN01A040M	*	*	*	*	*	*	*	*	*	*	*	7.17	3.98	2.60	1.35
4.0	1	266RL-22RN01F040E	*	*	*	*	*	*	*	*	*	*	*	*	7.17	3.98	2.60	1.35

Roscas internas versão esquerda

TPI	NT	Código para pedido	P		M		K		N		S		H		Dimensões, mm			
			1020	1125	1020	1125	1020	1125	1020	1125	1020	1125	HA	HB	PDX	PDY		
			*	*	*	*	*	*	*	*	*	*	*	*	*	*	*	*
16	10.0	1	266LL-16RN01A100M	*	*	*	*	*	*	*	*	*	*	*	2.87	1.58	0.85	1.30
8.0	1	266LL-16RN01A080M	*	*	*	*	*	*	*	*	*	*	*	*	3.59	2.00	1.05	1.30
6.0	1	266LL-16RN01A060M	*	*	*	*	*	*	*	*	*	*	*	*	4.79	2.66	1.35	1.45
22	4.0	1	266LL-22RN01A040M	*	*	*	*	*	*	*	*	*	*	*	7.17	3.98	2.60	1.35

R = versão direita, L = versão esquerda



C30



C39

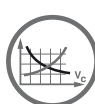

C73



C83



H36



H35



H26



A

Pastilha CoroThread® 266 para torneamento de roscas

MJ 60° Perfil completo

STDNO
TCTRISO 5855-1983
IT 4-6

B

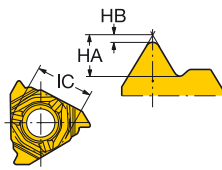
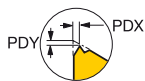
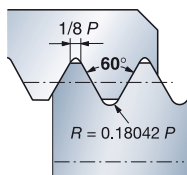

C

Roscas externas versão direita

TP	NT	Código para pedido	P	M	K	N	S	H	Dimensões, mm				
			1125	1125	1125	1125	1125	1125	HA	HB	PDX	PDY	
16	1.50	1	266RG-16MJ01A150E	★	★	★	★	★	☆	1.12	0.25	1.00	1.32
	2.00	1	266RG-16MJ01A200E	★	★	★	★	★	☆	1.50	0.34	1.40	1.32

D

Roscas externas versão esquerda

TP	NT	Código para pedido	P	M	K	N	S	H	Dimensões, mm				
			1125	1125	1125	1125	1125	1125	HA	HB	PDX	PDY	
16	1.50	1	266LG-16MJ01A150E	★	★	★	★	★	☆	1.12	0.25	1.00	1.32
	2.00	1	266LG-16MJ01A200E	★	★	★	★	★	☆	1.50	0.34	1.40	1.32

R = versão direita, L = versão esquerda

E

Roscas internas

Nota: Para toronar uma rosca MJ interna, use pastilha e barra de mandrilar CoroTurn 107 para usinar o diâmetro interno correto e então produza a rosca com uma pastilha ISO métrica 60° (MM) correspondente.

F

G

H



C30



C39



C73



C83



H36



H35



H26

Pastilha CoroThread® 266 para torneamento de roscas

UNJ 60° Perfil completo

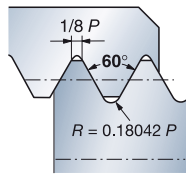

STDNO
STDNO
TCTR

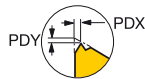

ISO 3161-1977
BS 4084-1977
3A

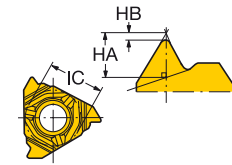

Roscas externas versão direita

TPI	NT	Código para pedido	Dimensões, mm										
			P	M	K	N	S	H	HA	HB	PDX	PDY	
16	32.0	1	266RG-16NJ01A320E	*	*	*	*	*	*	0.59	0.13	0.50	1.32
28.0	1	266RG-16NJ01A280E	*	*	*	*	*	*	0.67	0.15	0.80	1.32	
24.0	1	266RG-16NJ01A240E	*	*	*	*	*	*	0.79	0.18	0.80	1.32	
20.0	1	266RG-16NJ01A200E	*	*	*	*	*	*	0.94	0.21	1.00	1.32	
18.0	1	266RG-16NJ01A180E	*	*	*	*	*	*	1.05	0.23	1.00	1.32	
16.0	1	266RG-16NJ01A160E	*	*	*	*	*	*	1.18	0.26	1.00	1.32	
14.0	1	266RG-16NJ01A140E	*	*	*	*	*	*	1.35	0.30	1.20	1.32	
12.0	1	266RG-16NJ01A120E	*	*	*	*	*	*	1.58	0.36	1.40	1.32	
10.0	1	266RG-16NJ01A100E	*	*	*	*	*	*	1.89	0.42	1.40	1.32	
8.0	1	266RG-16NJ01A080E	*	*	*	*	*	*	2.38	0.53	1.80	1.32	

R = versão direita

Roscas internas

Nota: Para tornear uma rosca UNJ interna, use pastilha e barra de mandrilar CoroTurn 107 para usinar o diâmetro interno correto e então produza a rosca com uma pastilha UN 60° correspondente.



C30



C39



C73



C83



H36



H35



H26

A

Pastilha CoroThread® 266 para torneamento de roscas

ISO Trapezoidal 30° Perfil da crista chanfrado

STDNO
STDNO
TCTR

ISO 2901-2904
DIN 103-1977
7

B

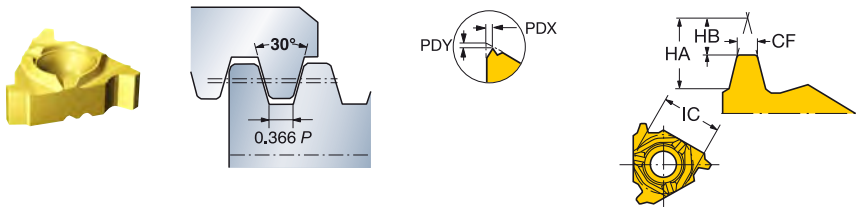

Roscas externas versão direita

C

TP	NT	Código para pedido	P		M		K		N		S		H		Dimensões, mm					
			1020	1135	1020	1135	1020	1135	1020	1135	1020	1135	1020	1135	CF	HA	HB	PDX	PDY	
16	1.50	1	266RG-16TR01F150E	*	*	*	*	*	*	*	*	*	*	*	☆	0.5	1.85	0.88	1.00	1.32
	2.00	1	266RG-16TR01F200E	*	*	*	*	*	*	*	*	*	*	*	☆	0.6	2.44	1.13	1.10	1.32
	3.00	1	266RG-16TR01F300E	*	*	*	*	*	*	*	*	*	*	*	☆	1.0	3.63	1.82	1.60	1.23
22	4.00	1	266RG-22TR01F400E	*	*	*	*	*	*	*	*	*	*	*	☆	1.3	4.82	2.50	1.90	1.38
	5.00	1	266RG-22TR01F500E	*	*	*	*	*	*	*	*	*	*	*	☆	1.7	6.01	3.18	2.10	1.38
	6.00	1	266RG-22TR01F600E	*	*	*	*	*	*	*	*	*	*	*	☆	1.9	7.20	3.62	2.40	0.79
	7.00	1	266RG-22TR01F700E	*	*	*	*	*	*	*	*	*	*	*	☆	2.3	8.38	4.31	2.40	0.79
27	8.00	1	266RG-27TR01F800E	*	*	*	*	*	*	*	*	*	*	☆	2.7	9.57	5.00	3.30	0.54	

Roscas externas versão esquerda

E

TP	NT	Código para pedido	P		M		K		N		S		H		Dimensões, mm					
			1020	1135	1020	1135	1020	1135	1020	1135	1020	1135	1020	1135	CF	HA	HB	PDX	PDY	
16	1.50	1	266LG-16TR01F150E	*	*	*	*	*	*	*	*	*	*	*	☆	0.5	1.85	0.88	1.00	1.32
	2.00	1	266LG-16TR01F200E	*	*	*	*	*	*	*	*	*	*	*	☆	0.6	2.44	1.13	1.10	1.33
	3.00	1	266LG-16TR01F300E	*	*	*	*	*	*	*	*	*	*	*	☆	1.0	3.63	1.82	1.60	1.23
22	4.00	1	266LG-22TR01F400E	*	*	*	*	*	*	*	*	*	*	*	☆	1.3	4.82	2.50	1.90	1.38
	5.00	1	266LG-22TR01F500E	*	*	*	*	*	*	*	*	*	*	*	☆	1.7	6.01	3.18	2.10	1.38
	6.00	1	266LG-22TR01F600E	*	*	*	*	*	*	*	*	*	*	*	☆	1.9	7.20	3.62	2.40	0.79
	7.00	1	266LG-22TR01F700E	*	*	*	*	*	*	*	*	*	*	*	☆	2.3	8.38	4.31	2.40	0.79

Roscas internas versão direita

F

TP	NT	Código para pedido	P		M		K		N		S		H		Dimensões, mm					
			1020	1135	1020	1135	1020	1135	1020	1135	1020	1135	1020	1135	CF	HA	HB	PDX	PDY	
16	2.00	1	266RL-16TR01F200E	*	*	*	*	*	*	*	*	*	*	*	☆	0.6	2.41	1.08	1.10	1.30
	3.00	1	266RL-16TR01F300E	*	*	*	*	*	*	*	*	*	*	*	☆	0.9	3.59	1.76	1.60	1.21
22	4.00	1	266RL-22TR01F400E	*	*	*	*	*	*	*	*	*	*	*	☆	1.3	4.77	2.45	1.90	1.35
	5.00	1	266RL-22TR01F500E	*	*	*	*	*	*	*	*	*	*	*	☆	1.7	5.96	3.13	2.10	1.35
	6.00	1	266RL-22TR01F600E	*	*	*	*	*	*	*	*	*	*	*	☆	1.9	7.14	3.56	2.40	0.77
	7.00	1	266RL-22TR01F700E	*	*	*	*	*	*	*	*	*	*	*	☆	2.3	8.32	4.25	2.40	0.96
	27	8.00	1	266RL-27TR01F800E	*	*	*	*	*	*	*	*	*	*	☆	2.6	9.49	4.93	3.30	0.54

Roscas internas versão esquerda

G

TP	NT	Código para pedido	P		M		K		N		S		H		Dimensões, mm					
			1020	1135	1020	1135	1020	1135	1020	1135	1020	1135	1020	1135	CF	HA	HB	PDX	PDY	
16	2.00	1	266LL-16TR01F200E	*	*	*	*	*	*	*	*	*	*	*	☆	0.6	2.41	1.08	1.20	1.30
	3.00	1	266LL-16TR01F300E	*	*	*	*	*	*	*	*	*	*	*	☆	0.9	3.59	1.76	1.35	1.45
22	4.00	1	266LL-22TR01F400E	*	*	*	*	*	*	*	*	*	*	*	☆	1.3	4.77	2.45	1.90	1.35
	5.00	1	266LL-22TR01F500E	*	*	*	*	*	*	*	*	*	*	*	☆	1.7	5.96	3.13	2.10	1.35
	6.00	1	266LL-22TR01F600E	*	*	*	*	*	*	*	*	*	*	*	☆	1.9	7.14	3.56	2.40	0.77
	7.00	1	266LL-22TR01F700E	*	*	*	*	*	*	*	*	*	*	*	☆	2.3	8.32	4.25	2.40	0.96

R = versão direita, L = versão esquerda

H



Pastilha CoroThread® 266 para torneamento de roscas

ACME 29° Perfil da crista chanfrado

STDNO
TCTR

ANSI B1.5-1988
2G

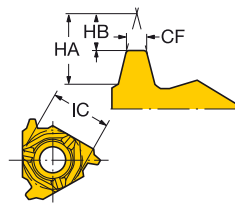
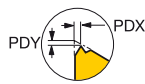
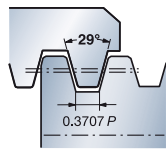

Roscas externas versão direita

TPI	NT	Código para pedido	P		M		K		N		S		H		Dimensões, mm					
			1020	1135	1020	1135	1020	1135	1020	1135	1020	1135	1020	1135	CF	HA	HB	PDX	PDY	
16	16.0	1	266RG-16AC01F160E	★	★	★	★	★	★	★	★	★	★	★	☆	0.5	1.98	1.04	1.00	1.33
	14.0	1	266RG-16AC01F140E	★	★	★	★	★	★	★	★	★	★	★	☆	0.6	2.26	1.21	1.10	1.33
	12.0	1	266RG-16AC01F120E	★	★	★	★	★	★	★	★	★	★	★	☆	0.7	2.64	1.43	1.20	1.33
	10.0	1	266RG-16AC01F100E	★	★	★	★	★	★	★	★	★	★	★	☆	0.8	3.16	1.61	1.30	1.32
22	8.0	1	266RG-16AC01F080E	★	★	★	★	★	★	★	★	★	★	★	☆	1.1	3.94	2.08	1.50	1.23
	6.0	1	266RG-22AC01F060E	★	★	★	★	★	★	★	★	★	★	★	☆	1.5	5.25	2.84	1.90	1.38
	5.0	1	266RG-22AC01F050E	★	★	★	★	★	★	★	★	★	★	★	☆	1.8	6.29	3.47	2.10	1.38
27	4.0	1	266RG-22AC01F040E	★	★	★	★	★	★	★	★	★	★	★	☆	2.3	7.87	4.41	2.40	0.79
	3.0	1	266RG-27AC01F030E	★	★	★	★	★	★	★	★	★	★	★	☆	3.1	10.47	5.95	3.30	0.54

Roscas externas versão esquerda

TPI	NT	Código para pedido	P		M		K		N		S		H		Dimensões, mm					
			1020	1135	1020	1135	1020	1135	1020	1135	1020	1135	1020	1135	CF	HA	HB	PDX	PDY	
16	12.0	1	266LG-16AC01F120E	★	★	★	★	★	★	★	★	★	★	★	☆	0.7	2.64	1.43	1.20	1.33
	10.0	1	266LG-16AC01F100E	★	★	★	★	★	★	★	★	★	★	★	☆	0.8	3.16	1.61	1.30	1.33
	8.0	1	266LG-16AC01F080E	★	★	★	★	★	★	★	★	★	★	★	☆	1.1	3.94	2.08	1.50	1.23
22	6.0	1	266LG-22AC01F060E	★	★	★	★	★	★	★	★	★	★	★	☆	1.5	5.25	2.84	1.90	1.38
	5.0	1	266LG-22AC01F050E	★	★	★	★	★	★	★	★	★	★	★	☆	1.8	6.29	3.47	2.10	1.38
	4.0	1	266LG-22AC01F040E	★	★	★	★	★	★	★	★	★	★	★	☆	2.3	7.87	4.41	2.40	0.79

Roscas internas versão direita

TPI	NT	Código para pedido	P		M		K		N		S		H		Dimensões, mm								
			1020	1125	1135	1020	1125	1135	1020	1125	1135	1020	1125	1135	1020	1125	1135	CF	HA	HB	PDX	PDY	
16	16.0	1	266RL-16AC01F160E			★			★				★				☆	0.5	1.97	1.00	1.00	1.30	
	14.0	1	266RL-16AC01F140E			★			★				★				☆	0.6	2.25	1.16	1.10	1.30	
	12.0	1	266RL-16AC01F120E			★			★				★				☆	0.7	2.62	1.37	1.20	1.30	
	10.0	1	266RL-16AC01F100E			★			★				★				☆	0.8	3.13	1.54	1.30	1.30	
22	8.0	1	266RL-16AC01F080E			★			★				★				☆	1.0	3.90	2.00	1.50	1.21	
	6.0	1	266RL-22AC01A060M		★			★		★			★				☆	1.4	5.19	2.76	1.90	1.01	
	6.0	1	266RL-22AC01F060E	★			★		★				★				☆	1.4	5.19	2.76	1.90	1.35	
	5.0	1	266RL-22AC01F050E	★			★		★				★				☆	1.7	6.22	3.37	2.10	0.96	
	4.0	1	266RL-22AC01F040E	★			★		★				★				☆	2.2	7.77	4.28	2.40	0.87	
	27	3.0	1	266RL-27AC01F030E	★			★		★				★				☆	3.0	10.31	5.80	3.30	0.54

Roscas internas versão esquerda

TPI	NT	Código para pedido	P		M		K		N		S		H		Dimensões, mm					
			1020	1135	1020	1135	1020	1135	1020	1135	1020	1135	1020	1135	CF	HA	HB	PDX	PDY	
16	12.0	1	266LL-16AC01F120E	★	★	★	★	★	★	★	★	★	★	★	☆	0.7	2.62	1.37	1.20	1.30
	10.0	1	266LL-16AC01F100E	★	★	★	★	★	★	★	★	★	★	★	☆	0.8	3.13	1.54	1.30	1.30
	8.0	1	266LL-16AC01F080E	★	★	★	★	★	★	★	★	★	★	★	☆	1.0	3.90	2.00	1.50	1.21
22	6.0	1	266LL-22AC01F060E	★	★	★	★	★	★	★	★	★	★	★	☆	1.4	5.19	2.76	1.90	1.35
	5.0	1	266LL-22AC01F050E	★	★	★	★	★	★	★	★	★	★	★	☆	1.7	6.22	3.37	2.00	0.96
	4.0	1	266LL-22AC01F040E	★	★	★	★	★	★	★	★	★	★	★	☆	2.2	7.77	4.28	2.40	0.70

R = versão direita, L = versão esquerda



C30



C39



C73



C83



H36



H35



H26

Pastilha CoroThread® 266 para torneamento de roscas

STUB-ACME 29° Perfil da crista chanfrado

STDNO
TCTR

ANSI B1.8-1988
2G

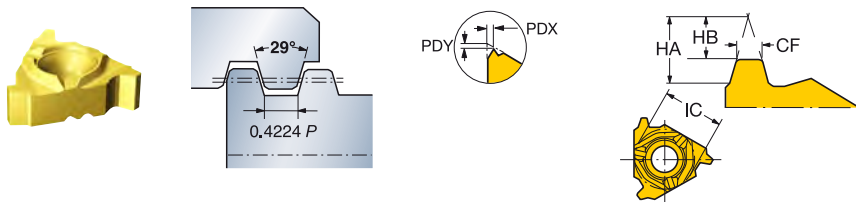

Roscas externas versão direita

TPI	NT	Código para pedido	P		M		K		N		S		H		Dimensões, mm					
			1020	1135	1020	1135	1020	1135	1020	1135	1020	1135	1020	1135	1020	1135	CF	HA	HB	PDX
16	16.0	1	266RG-16SA01F160E	★		★		★		★		★		★	☆	0.6	1.86	1.21	1.50	1.23
	14.0	1	266RG-16SA01F140E	★		★		★		★		★		★	☆	0.7	2.12	1.40	1.85	1.30
	12.0	1	266RG-16SA01F120E	★		★		★		★		★		★	☆	0.9	2.47	1.65	1.10	1.32
	10.0	1	266RG-16SA01F100E	★		★		★		★		★		★	☆	1.0	2.95	1.87	1.20	1.32
	8.0	1	266RG-16SA01F080E	★		★		★		★		★		★	☆	1.2	3.67	2.39	1.50	1.53
22	6.0	1	266RG-22SA01F060E	★		★		★		★		★		★	☆	1.7	4.86	3.27	1.80	1.67
	5.0	1	266RG-22SA01F050E	★		★		★		★		★		★	☆	2.1	5.83	3.98	2.00	1.67
	4.0	1	266RG-22SA01F040E	★		★		★		★		★		★	☆	2.6	7.27	5.05	2.40	1.67
27	3.0	1	266RG-27SA01F030E	★		★		★		★		★		★	☆	3.5	9.66	6.81	3.10	1.72

Roscas externas versão esquerda

TPI	NT	Código para pedido	P		M		K		N		S		H		Dimensões, mm					
			1020	1135	1020	1135	1020	1135	1020	1135	1020	1135	1020	1135	CF	HA	HB	PDX	PDY	
16	16.0	1	266LG-16SA01F160E	★		★		★		★		★		★	☆	0.6	1.86	1.21	1.30	1.30
	14.0	1	266LG-16SA01F140E	★		★		★		★		★		★	☆	0.7	2.12	1.40	1.10	1.32
	12.0	1	266LG-16SA01F120E	★		★		★		★		★		★	☆	0.9	2.47	1.65	1.50	1.30
	10.0	1	266LG-16SA01F100E	★		★		★		★		★		★	☆	1.0	2.95	1.87	1.30	1.30
	8.0	1	266LG-16SA01F080E	★		★		★		★		★		★	☆	1.2	3.67	2.89	1.10	1.30
22	6.0	1	266LG-22SA01F060E	★		★		★		★		★		★	☆	1.7	4.86	3.27	1.80	1.67
	5.0	1	266LG-22SA01F050E	★		★		★		★		★		★	☆	2.1	5.83	3.98	2.00	1.67
	4.0	1	266LG-22SA01F040E	★		★		★		★		★		★	☆	2.6	7.27	5.05	2.40	1.67

Roscas internas versão direita

TPI	NT	Código para pedido	P		M		K		N		S		H		Dimensões, mm					
			1020	1135	1020	1135	1020	1135	1020	1135	1020	1135	1020	1135	CF	HA	HB	PDX	PDY	
16	16.0	1	266RL-16SA01F160E	★		★		★		★		★		★	☆	0.6	1.81	1.15	1.00	1.30
	14.0	1	266RL-16SA01F140E	★		★		★		★		★		★	☆	0.7	2.07	1.34	0.80	1.30
	12.0	1	266RL-16SA01F120E	★		★		★		★		★		★	☆	0.9	2.40	1.59	1.10	1.30
	10.0	1	266RL-16SA01F100E	★		★		★		★		★		★	☆	0.9	2.88	1.80	1.20	1.30
	8.0	1	266RL-16SA01F080E	★		★		★		★		★		★	☆	1.2	3.59	2.31	1.50	1.50
22	6.0	1	266RL-22SA01F060E	★		★		★		★		★		★	☆	1.6	4.77	3.18	1.80	1.64
	5.0	1	266RL-22SA01F050E	★		★		★		★		★		★	☆	2.0	5.71	3.87	2.00	1.64
	4.0	1	266RL-22SA01F040E	★		★		★		★		★		★	☆	2.5	7.13	4.91	2.40	1.64
27	3.0	1	266RL-27SA01F030E	★		★		★		★		★		★	☆	3.4	9.49	6.64	3.10	1.72

Roscas internas versão esquerda

TPI	NT	Código para pedido	P		M		K		N		S		H		Dimensões, mm					
			1020	1135	1020	1135	1020	1135	1020	1135	1020	1135	1020	1135	CF	HA	HB	PDX	PDY	
16	12.0	1	266LL-16SA01F120E	★		★		★		★		★		★	☆	0.9	2.40	1.59	1.20	1.32
	10.0	1	266LL-16SA01F100E	★		★		★		★		★		★	☆	0.9	2.88	1.80	1.50	1.52
	8.0	1	266LL-16SA01F080E	★		★		★		★		★		★	☆	1.2	3.59	2.31	1.05	1.30
22	6.0	1	266LL-22SA01F060E	★		★		★		★		★		★	☆	1.6	4.77	3.18	1.80	1.64
	5.0	1	266LL-22SA01F050E	★		★		★		★		★		★	☆	2.0	5.71	3.87	2.00	1.64
	4.0	1	266LL-22SA01F040E	★		★		★		★		★		★	☆	2.5	7.13	4.91	2.40	1.64

R = versão direita, L = versão esquerda



Pastilha CoroThread® 266 para torneamento de roscas

API 60° Perfil completo para conexões a 90 graus

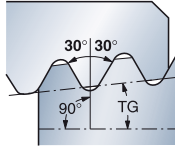

STDNO

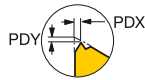

API SPEC. 7

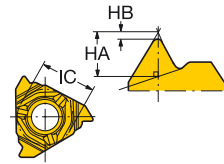

Roscas externas versão direita

TPI	NT	Código para pedido	P		M		K		N		S		H		Dimensões, mm					
			1020	1125	1020	1125	1020	1125	1020	1125	1020	1125	1020	1125	HA	HB	PDX	PDY	TG	
22	5.0	1	266RG-22V401A0503E	☆	★	☆	★	☆	★	☆	★	☆	★	☆	★	3.48	0.50	2.50	1.38	0.13
	4.0	1	266RG-22V381A0402E	☆	★	☆	★	☆	★	☆	★	☆	★	☆	★	4.03	0.95	2.50	1.67	0.08
	4.0	1	266RG-22V381A0403E	☆	★	☆	★	☆	★	☆	★	☆	★	☆	★	4.02	0.95	2.60	1.72	0.13
	4.0	1	266RG-22V501A0402E	☆	★	☆	★	☆	★	☆	★	☆	★	☆	★	4.36	0.62	2.80	0.98	0.08
	4.0	1	266RG-22V501A0403E	☆	★	☆	★	☆	★	☆	★	☆	★	☆	★	4.35	0.62	2.80	1.08	0.13
27	5.0	1	266RG-27V401A0503E	☆	★	☆	★	☆	★	☆	★	☆	★	☆	★	3.48	0.50	2.50	1.92	0.13
	4.0	1	266RG-27V381A0402E	☆	★	☆	★	☆	★	☆	★	☆	★	☆	★	4.03	0.95	2.60	2.41	0.08
	4.0	1	266RG-27V381A0403E	☆	★	☆	★	☆	★	☆	★	☆	★	☆	★	4.02	0.95	2.70	2.41	0.13
	4.0	1	266RG-27V501A0402E	☆	★	☆	★	☆	★	☆	★	☆	★	☆	★	4.36	0.62	2.80	1.92	0.08
	4.0	1	266RG-27V501A0403E	☆	★	☆	★	☆	★	☆	★	☆	★	☆	★	4.35	0.62	2.90	1.92	0.13

Roscas internas versão direita

TPI	NT	Código para pedido	P		M		K		N		S		H		Dimensões, mm					
			1020	1125	1020	1125	1020	1125	1020	1125	1020	1125	1020	1125	HA	HB	PDX	PDY	TG	
22	5.0	1	266RL-22V401A0503E	☆	★	☆	★	☆	★	☆	★	☆	★	☆	★	3.48	0.50	2.50	1.35	0.13
	4.0	1	266RL-22V381A0402E	☆	★	☆	★	☆	★	☆	★	☆	★	☆	★	4.03	0.95	2.60	1.74	0.08
	4.0	1	266RL-22V381A0403E	☆	★	☆	★	☆	★	☆	★	☆	★	☆	★	4.02	0.95	2.60	1.74	0.13
	4.0	1	266RL-22V501A0402E	☆	★	☆	★	☆	★	☆	★	☆	★	☆	★	4.36	0.62	2.80	1.06	0.08
	4.0	1	266RL-22V501A0403E	☆	★	☆	★	☆	★	☆	★	☆	★	☆	★	4.35	0.62	2.90	1.16	0.13
27	5.0	1	266RL-27V401A0503E	☆	★	☆	★	☆	★	☆	★	☆	★	☆	★	3.48	0.50	2.50	1.92	0.13
	4.0	1	266RL-27V381A0402E	☆	★	☆	★	☆	★	☆	★	☆	★	☆	★	4.03	0.95	2.60	2.41	0.08
	4.0	1	266RL-27V381A0403E	☆	★	☆	★	☆	★	☆	★	☆	★	☆	★	4.02	0.95	2.70	2.41	0.13
	4.0	1	266RL-27V501A0402E	☆	★	☆	★	☆	★	☆	★	☆	★	☆	★	4.36	0.62	2.80	1.92	0.08
	4.0	1	266RL-27V501A0403E	☆	★	☆	★	☆	★	☆	★	☆	★	☆	★	4.35	0.62	2.90	1.92	0.13

R = versão direita, L = versão esquerda



C30



C39



C73



C83



H36



H35



H26



A

Pastilha CoroThread® 266 para torneamento de roscas

API Round 60° Perfil completo

B

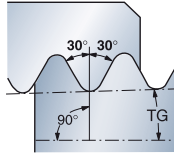

STDNO

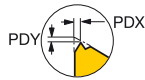

API SPEC. 5B

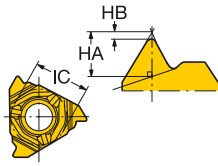

C

Roscas externas versão direita

TPI	NT	Código para pedido	P		M		K		N		S		H		Dimensões, mm				
			1020	1125	1020	1125	1020	1125	1020	1125	1020	1125	1020	1125	HA	HB	PDX	PDY	TG
16	10.0	1	★	★	★	★	★	★	★	★	★	★	★	★	1.76	0.36	1.30	1.35	0.03
10.0	1	266RG-16RD01C100M	★	★	★	★	★	★	★	★	★	★	★	★	1.76	0.36	1.30	1.35	0.03
8.0	1	266RG-16RD01A080E	★	★	★	★	★	★	★	★	★	★	★	★	2.23	0.43	1.50	1.35	0.03
8.0	1	266RG-16RD01C080M	★	★	★	★	★	★	★	★	★	★	★	★	2.23	0.43	1.50	1.35	0.03
22	10.0	1	★	★	★	★	★	★	★	★	★	★	★	★	1.76	0.36	2.00	1.67	0.03
8.0	1	266RG-22RD01A080E	★	★	★	★	★	★	★	★	★	★	★	★	2.23	0.43	2.00	1.67	0.03

D

Roscas internas versão direita

TPI	NT	Código para pedido	P			M			K			N			S			H			Dimensões, mm				
			1020	1125	1135	1020	1125	1135	1020	1125	1135	1020	1125	1135	1020	1125	1135	1020	1125	1135	HA	HB	PDX	PDY	TG
16	10.0	1	★	★	★	★	★	★	★	★	★	★	★	★	★	★	★	★	★	★	1.76	0.36	1.30	1.30	0.03
10.0	1	266RL-16RD01C100M	★	★	★	★	★	★	★	★	★	★	★	★	★	★	★	★	★	★	1.76	0.36	1.30	1.30	0.03
8.0	1	266RL-16RD01A080E	★	★	★	★	★	★	★	★	★	★	★	★	★	★	★	★	★	★	2.24	0.43	1.50	1.30	0.03
8.0	1	266RL-16RD01C080M	★	★	★	★	★	★	★	★	★	★	★	★	★	★	★	★	★	★	2.24	0.43	1.50	1.30	0.03
22	10.0	1	★	★	★	★	★	★	★	★	★	★	★	★	★	★	★	★	★	★	1.76	0.36	2.00	1.64	0.03
8.0	1	266RL-22RD01A080E	★	★	★	★	★	★	★	★	★	★	★	★	★	★	★	★	★	★	2.24	0.43	2.00	1.64	0.03

R = versão direita

F

G

H

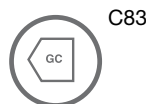
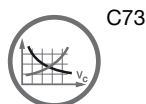
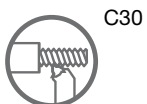

Pastilha CoroThread® 266 para torneamento de roscas

API Perfil completo para carcaças e tubos

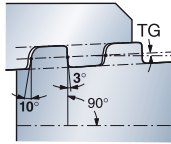
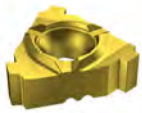

STDNO

API SPEC. 5B

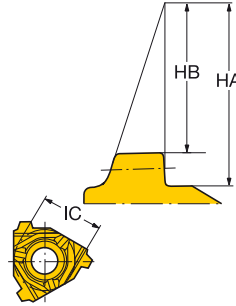
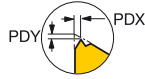

Roscas externas versão direita

TPI	NT	Código para pedido	Dimensões, mm						HA	HB	PDX	PDY	TG							
			P	M	K	N	S	H												
22	5.0	1	266RG-22BU01A0501E	☆	★	☆	★	☆	★	☆	★	☆	★	☆	★	12.06	10.60	2.50	1.97	0.04
	5.0	1	266RG-22BU01A050E	☆	★	☆	★	☆	★	☆	★	☆	★	☆	★	12.05	10.47	2.50	1.97	0.03

Roscas internas versão direita

TPI	NT	Código para pedido	Dimensões, mm						HA	HB	PDX	PDY	TG							
			P	M	K	N	S	H												
22	5.0	1	266RL-22BU01A0501E	☆	★	☆	★	☆	★	☆	★	☆	★	☆	★	12.04	10.62	2.21	1.93	0.04
	5.0	1	266RL-22BU01A050E	☆	★	☆	★	☆	★	☆	★	☆	★	☆	★	12.18	10.60	2.31	1.93	0.03

R = versão direita



C30



C39

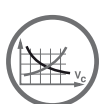

C73



C83



H36



H35



H26

A

Unidade de corte CoroThread® 266 para torneamento de roscas

Fixação por parafuso

Coromant Capto® - Refrigeração de precisão

B

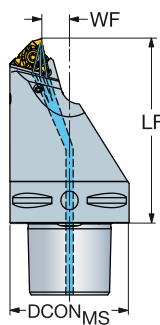
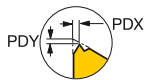

C



266 R/LG

D

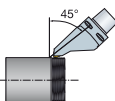

CZC _{MS}	CNSC	Código para pedido	Dimensões, mm						MIID		
			DCON _{MS}	LF	WF	THCA	BAR	NM		KG	
16	C6	3	C6-266RS18100-16HP	63.0	100.0	18.0	1°	80	3.5	2.00	266.RG-16..
22	C6	3	C6-266RS16100-22HP	63.0	100.0	16.0	1°	80	5.0	1.94	266.RG-22..

Para valores PDX/PDY - consulte a página da pastilha.

Para recomendações de penetração, veja a página C77

Ângulo de inclinação (THCA) com diferentes calços, veja a página C75

R = versão direita

Nota:

Em uma máquina multitarefas, a ferramenta deve ser inclinada 45 graus, caso contrário, o porta-ferramenta, eixo B, irá interferir com o mandril.

E

Componentes					
CZC _{MS}	Parafuso	Calço	Parafuso do calço	Olhal	
16	C6	5513 020-13	5322 389-11	5512 032-05	5691 026-13
22	C6	5513 020-26	5322 379-11	5512 032-04	5691 026-13

Para a lista completa de componentes, acesse www.sandvik.coromant.com

F

G

H



C2



F2



E1



G1



H36



H27



H5

Unidade de corte CoroThread® 266 para torneamento de roscas

Fixação por parafuso

Coromant Capto® - Refrigeração interna



266 R/LG



Cx-266R/LFG

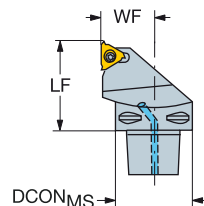

Cx-266R/LFGZ

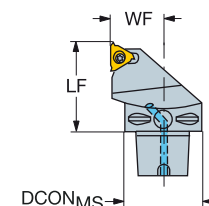

Código para pedido	CZC _{MS}	CNSC	Código para pedido	Dimensões, mm								MIID
				DCON _{MS}	LF	WF	THCA	BAR	NM	KG		
16	C3	3	C3-266R/LFG-22040-16	32.0	40.0	22.0	1°	10	3.0	0.23	266.LG-16..	
	C4	3	C4-266R/LFG-27050-16	40.0	50.0	27.0	1°	10	3.0	0.46	266.LG-16..	
	C5	3	C5-266R/LFG-35060-16	50.0	60.0	35.0	1°	10	3.0	0.77	266.LG-16..	
	C6	3	C6-266R/LFG-45065-16	63.0	65.0	45.0	1°	10	3.0	1.29	266.LG-16..	
22	C3	3	C3-266RFG-22040-22	32.0	40.0	22.0	1°	10	5.0	0.23	266.RG-22..	
	C4	3	C4-266R/LFG-27050-22	40.0	50.0	27.0	1°	10	5.0	0.42	266.LG-22..	
	C5	3	C5-266R/LFG-35060-22	50.0	60.0	35.0	1°	10	5.0	0.77	266.LG-22..	
	C6	3	C6-266R/LFG-45065-22	63.0	65.0	45.0	1°	10	5.0	1.31	266.LG-22..	
27	C8	3	C8-266R/LFG-55080-22	80.0	80.0	55.0	1°	10	5.0	2.54	266.LG-22..	
	C6	3	C6-266R/LFG-45065-27	63.0	65.0	45.0	1°	10	7.5	1.31	266.LG-27..	

Código para pedido	CZC _{MS}	CNSC	Código para pedido	Dimensões, mm								MIID
				DCON _{MS}	LF	WF	THCA	BAR	NM	KG		
16	C4	3	C4-266RFGZ27050-16	40.0	50.0	27.0	1°	10	3.0	0.42	266.RG-16..	
	C5	3	C5-266RFGZ35060-16	50.0	60.0	35.0	1°	10	3.0	0.77	266.RG-16..	
	C6	3	C6-266RFGZ45065-16	63.0	65.0	45.0	1°	10	3.0	1.30	266.RG-16..	
22	C4	3	C4-266RFGZ27050-22	40.0	50.0	27.0	1°	10	5.0	0.42	266.RG-22..	
	C5	3	C5-266RFGZ35060-22	50.0	60.0	35.0	1°	10	5.0	0.77	266.RG-22..	
	C6	3	C6-266RFGZ45065-22	63.0	65.0	45.0	1°	10	5.0	1.32	266.RG-22..	

Para valores PDX/PDY - consulte a página da pastilha.

R = versão direita, L = versão esquerda

Para recomendações de penetração, veja a página C77

Ângulo de inclinação (THCA) com diferentes calços, veja a página C75

Código para pedido	Componentes				
	Parafuso da pastilha	Calço versão esquerda	Calço versão direita	Parafuso do calço	Olhal
C3-266R/LFG-22040-16	5513 020-13	5322 390-11	5322 389-11	5512 032-05	5691 034-01
C4-266R/LFG-27050-16	5513 020-13	5322 390-11	5322 389-11	5512 032-05	5691 034-01
C4-266RFGZ27050-16	5513 020-13		5322 389-11	5512 032-05	5691 034-01
C5-266R/LFG-35060-16	5513 020-13	5322 390-11	5322 389-11	5512 032-05	5691 034-02
C5-266RFGZ35060-16	5513 020-13		5322 389-11	5512 032-05	5691 034-02
C6-266R/LFG-45065-16	5513 020-13	5322 390-11	5322 389-11	5512 032-05	5691 034-02
C6-266RFGZ45065-16	5513 020-13		5322 389-11	5512 032-05	5691 034-02
C8-266R/LFG-55080-16	5513 020-13	5322 390-11	5322 389-11	5512 032-05	5691 034-03
C3-266R/LFG-22040-22	5513 020-26		5322 379-11	5512 032-04	5691 034-01
C4-266R/LFG-27050-22	5513 020-26	5322 380-11	5322 379-11	5512 032-04	5691 034-01
C4-266R/LFGZ27050-22	5513 020-26		5322 379-11	5512 032-04	5691 034-01
C5-266R/LFG-35060-22	5513 020-26	5322 380-11	5322 379-11	5512 032-04	5691 034-02
C5-266R/LFGZ35060-22	5513 020-26		5322 379-11	5512 032-04	5691 034-02
C6-266R/LFG-45065-22	5513 020-26	5322 380-11	5322 379-11	5512 032-04	5691 034-02
C6-266R/LFGZ45065-22	5513 020-26		5322 379-11	5512 032-04	5691 034-02
C8-266R/LFG-55080-22	5513 020-26	5322 380-11	5322 379-11	5512 032-04	5691 034-03
C6-266R/LFG-45065-27	5513 020-66	5322 388-11	5322 387-11	5512 032-03	5691 034-02

Para a lista completa de componentes, acesse www.sandvik.coromant.com



A

Unidade de corte CoroThread® 266 para torneamento de roscas

Fixação por parafuso

Coromant Capto® - Refrigeração de precisão

B

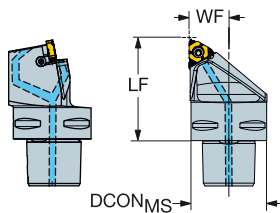

C



266 R/LG

Código para pedido	Dimensões, mm										MIID
	DCON _{MS}	LF	WF	THCA	BAR	NM	KG				
16	C3	3	C3-266-R/LFA17047-16C	32.0	47.0	17.0	1°	150	3.0	0.24	266.LG-16..
	C4	3	C4-266-R/LFA21055-16C	40.0	55.0	21.0	1°	150	3.0	0.42	266.LG-16..
	C5	3	C5-266-R/LFA26065-16C	50.0	65.0	26.0	1°	150	3.0	0.77	266.LG-16..
	C6	3	C6-266-R/LFA33075-16C	63.0	75.0	33.0	1°	150	3.0	1.34	266.LG-16..

D

Ângulo de inclinação (THCA) com diferentes calços, veja a página C75

R = versão direita, L = versão esquerda

Componentes

Parafuso da pastilha	Calço versão esquerda	Calço versão direita	Parafuso do calço	Olhal	Plugue	Plugue de refrigeração
5513 020-13	5322 392-11	5322 391-11	5512 032-05	5691 026-13	3214 013-02	5512 104-01

Para a lista completa de componentes, acesse www.sandvik.coromant.com

E

F

G

H



F2



H36



H5

Unidade de corte CoroThread® 266 para torneamento de roscas

Fixação por parafuso

Coromant Capto® - Refrigeração interna

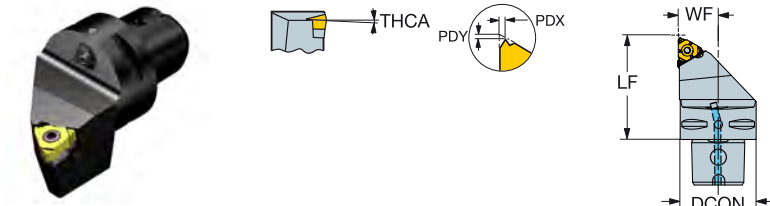

266 R/LG

	CZC _{MS}	CNSC	Código para pedido	Dimensões, mm							MID
				DCON _{MS}	LF	WF	THCA	BAR	NM	KG	
16	C3	3	C3-266RFAZ17039-16	32.0	39.0	17.0	1°	10	3.0	0.21	266.RG-16..
	C4	3	C4-266RFAZ21055-16	40.0	55.0	21.0	1°	10	3.0	0.42	266.RG-16..
	C5	3	C5-266RFAZ26065-16	50.0	65.0	26.0	1°	10	3.0	0.76	266.RG-16..
	C6	3	C6-266RFAZ33075-16	63.0	75.0	33.0	1°	10	3.0	1.34	266.RG-16..

Para valores PDX/PDY - consulte a página da pastilha.

R = versão direita, L = versão esquerda

Para recomendações de penetração, veja a página C77

Ângulo de inclinação (THCA) com diferentes calços, veja a página C75

Componentes					
	CZC _{MS}	Parafuso	Calço versão direita	Parafuso do calço	Olhal
16	C3-C4	5513 020-13	5322 391-11	5512 032-05	5691 034-01
16	C5-C6	5513 020-13	5322 391-11	5512 032-05	5691 034-02

Para a lista completa de componentes, acesse www.sandvik.coromant.com



A

CoroThread® 266 com haste convencional para torneamento de roscas

Fixação por parafuso

B

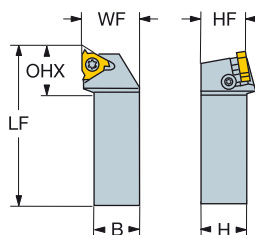
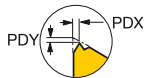
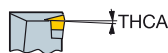

266 R/LG

C

CZC _{MS}	OHX	Código para pedido	Dimensões, mm										MIID
			B	H	LF	WF	HF	THCA	NM	KG			
16	16 x 16	21.4	266R/LFG-1616-16	16.0	16.0	100.0	20.0	16.0	1°	3.0	0.23	266.LG-16..	
	20 x 20	21.6	266R/LFG-2020-16	20.0	20.0	125.0	25.0	20.0	1°	3.0	0.42	266.LG-16..	
	25 x 25	22.2	266R/LFG-2525-16	25.0	25.0	150.0	32.0	25.0	1°	3.0	0.76	266.LG-16..	
	32 x 25	22.2	266R/LFG-3225-16	25.0	32.0	150.0	32.0	32.0	1°	3.0	1.08	266.LG-16..	
22	25 x 25	33.3	266R/LFG-2525-22	25.0	25.0	150.0	32.0	25.0	1°	5.0	0.76	266.LG-22..	
	32 x 32	34.3	266R/LFG-3232-22	32.0	32.0	170.0	40.0	32.0	1°	5.0	1.37	266.LG-22..	
	40 x 40	29.7	266R/LFG-4040-22	40.0	40.0	250.0	50.0	40.0	1°	5.0	3.14	266.LG-22..	
27	32 x 32	39.0	266R/LFG-3232-27	32.0	32.0	170.0	40.0	32.0	1°	7.5	1.40	266.LG-27..	
	40 x 40	34.6	266RFG-4040-27	40.0	40.0	250.0	50.0	40.0	1°	7.5	3.15	266.RG-27..	

Para valores PDX/PDY - consulte a página da pastilha.

R = versão direita, L = versão esquerda

Para recomendações de penetração, veja a página C77

Ângulo de inclinação (THCA) com diferentes calços, veja a página C75

D

E

Componentes					
CZC _{MS}	Parafuso	Calço versão esquerda	Calço versão direita	Parafuso do calço	
16	5513 020-13	5322 390-11	5322 389-11	5512 032-05	
22	5513 020-26	5322 380-11	5322 379-11	5512 032-04	
27	5513 020-66	5322 388-11	5322 387-11	5512 032-03	
27	5513 020-66		5322 387-11	5512 032-03	

Para a lista completa de componentes, acesse www.sandvik.coromant.com

F

G

H



C2



F2



E1



H36



H26

CoroThread® 266 com haste convencional para torneamento de roscas

Fixação por parafuso

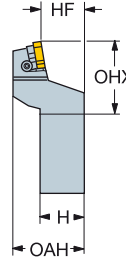
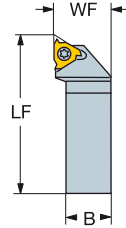
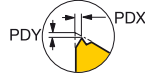

266 R/LG

		Dimensões, mm												
	CZC _{MS}	OHX	Código para pedido	B	H	LF	WF	HF	OAH	THCA	NM	KG	MIID	
	16	25 x 25	22.2	266R/LFGZ2525-16	25.0	25.0	150.0	32.0	25.0	44.0	1°	3.0	0.74	266.LG-16..
			22.2	266RFGZ3225-16	25.0	32.0	170.0	32.0	32.0	48.0	1°	3.0	1.05	266.RG-16..
	22	25 x 25	33.3	266R/LFGZ2525-22	25.0	25.0	150.0	32.0	25.0	46.0	1°	5.0	0.80	266.LG-22..
			34.3	266RFGZ3232-22	32.0	32.0	170.0	40.0	32.0	52.0	1°	5.0	1.34	266.RG-22..

Z = Para montagem invertida

R = versão direita, L = versão esquerda

Para valores PDX/PDY - consulte a página da pastilha.

Para recomendações de penetração, veja a página C77

Ângulo de inclinação (THCA) com diferentes calços, veja a página C75

Componentes					
	CZC _{MS}	Parafuso	Calço versão esquerda	Calço versão direita	Parafuso do calço
16	25 x 25	5513 020-13	5322 390-11	5322 389-11	5512 032-05
16	32 x 25	5513 020-13		5322 389-11	5512 032-05
22	25 x 25	5513 020-26	5322 380-11	5322 379-11	5512 032-04
22	32 x 32	5513 020-26		5322 379-11	5512 032-04

Para a lista completa de componentes, acesse www.sandvik.coromant.com

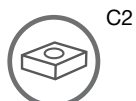

A

CoroThread® 266 com haste convencional para torneamento de roscas

Fixação por parafuso

B

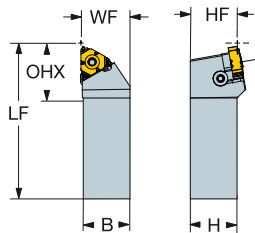

266 R/LG

C

	CZC _{MS}	OHX	Código para pedido	Dimensões, mm								MIID	
				B	H	LF	WF	HF	THCA	NM	KG		
	16	12 x 12	23.4	266R/LFA-1212-16	12.0	12.0	80.0	12.5	12.0	1°	3.0	0.13	266.LG-16..
		16 x 16	21.4	266R/LFA-1616-16	16.0	16.0	100.0	16.5	16.0	1°	3.0	0.21	266.LG-16..
		20 x 20	21.6	266R/LFA-2020-16	20.0	20.0	125.0	20.5	20.0	1°	3.0	0.40	266.LG-16..
		25 x 25	22.2	266R/LFA-2525-16	25.0	25.0	150.0	25.5	25.0	1°	3.0	0.73	266.LG-16..

D

Para rosqueamento próximo a uma contraponta

Para valores PDX/PDY - consulte a página da pastilha.

Para recomendações de penetração, veja a página C77

Ângulo de inclinação (THCA) com diferentes calços, veja a página C75

R = versão direita, L = versão esquerda

Componentes

Parafuso	Calço versão esquerda	Calço versão direita	Parafuso do calço
5513 020-13	5322 392-11	5322 391-11	5512 032-05

E

Para a lista completa de componentes, acesse www.sandvik.coromant.com

F

G

H



C2



F2



E1



H36



H26

CoroThread® 266 QS com haste convencional para torneamento de roscas

Fixação por parafuso

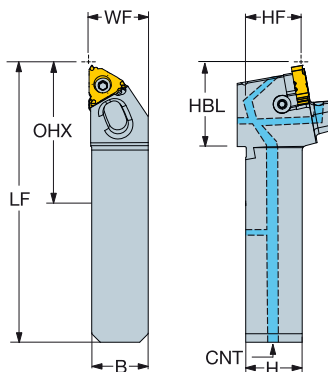

266 R/LG

CZC _{MS}	OHX	CNSC	Código para pedido	Dimensões, mm										MIID		
				B	H	HBL	LF	WF	HF	THCA	CNT	BAR	NM		KG	
16	20 x 20	50.0	3	QS-266-R/LFA2020-16C	20.0	20.0	30.0	99.0	20.9	20.0	1°	G 1/8-28	150	3.0	0.27	266.LG-16..
	25 x 25	55.0	3	QS-266-R/LFA2525-16C	25.0	25.0	30.0	114.0	25.9	25.0	1°	G 1/8-28	150	3.0	0.48	266.LG-16..
22	25 x 25	60.0	3	QS-266-R/LFA2525-22C	25.0	25.0	35.0	119.0	25.9	25.0	1°	G 1/8-28	150	5.0	0.51	266.LG-22..

Para valores PDX/PDY - consulte a página da pastilha.

R = versão direita, L = versão esquerda

Para recomendações de penetração, veja a página C77

Ângulo de inclinação (THCA) com diferentes calços, veja a página C75

Componentes									
CZC _{MS}	Parafuso da pastilha	Calço versão esquerda	Calço versão direita	Parafuso do calço	Olhal	Plugue	Plugue		
16	20 x 20-25 x 25 5513 020-13	5322 392-11	5322 391-11	5512 032-05	5691 026-13	3214 013-02	3214 013-03		
22	25 x 25 5513 020-26	5322 394-11	5322 393-11	5512 032-04	5691 026-13	3214 013-02	3214 013-03		

Componentes		
CZC _{MS}	Plugue	Plugue
16	3214 013-01	3214 012-01
22	3214 013-01	3214 012-01

Para a lista completa de componentes, acesse www.sandvik.coromant.com



C2



F2



E1



H36



H26



A

Cabeça CoroThread® 266 para torneamento de roscas

Fixação por parafuso

CoroTurn® SL - Refrigeração interna

B

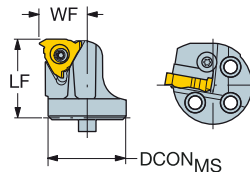
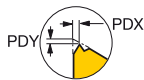

C



266 R/LG

D

		CZC _{MS}	CNSC	Código para pedido	Dimensões, mm						MIID	
					DCON _{MS}	LF	WF	THCA	BAR	NM		KG
	16	20	0	SL-266R/LFG-202514-16	20.0	25.0	14.0	1°	3.0	0.06	266.RG-16..	
		25	1	SL-266R/LFG-252517-16	25.0	25.0	17.0	1°	10	3.0	0.08	266.RG-16..
		32	1	SL-266R/LFG-323222-16	32.0	32.0	22.0	1°	10	3.0	0.14	266.RG-16..
		40	1	SL-266R/LFG-403227-16	40.0	32.0	27.0	1°	10	3.0	0.21	266.RG-16..

Quando usar uma cabeça de corte CoroThread 266 SL externa, a cabeça de corte direita usa uma pastilha externa esquerda e a cabeça de corte esquerda usa uma pastilha externa direita.

R = versão direita, L = versão esquerda

Para valores PDX/PDY - consulte a página da pastilha.

Para recomendações de penetração, veja a página C77

Ângulo de inclinação (THCA) com diferentes calços, veja a página C75

E

Para a lista completa de componentes, acesse www.sandvik.coromant.com

F

G

H



C2



F2



H36



H26



H5



H2

Unidade de corte CoroThread® 266 para torneamento de roscas

Fixação por parafuso

Coromant Capto® - Refrigeração interna



266 R/LL

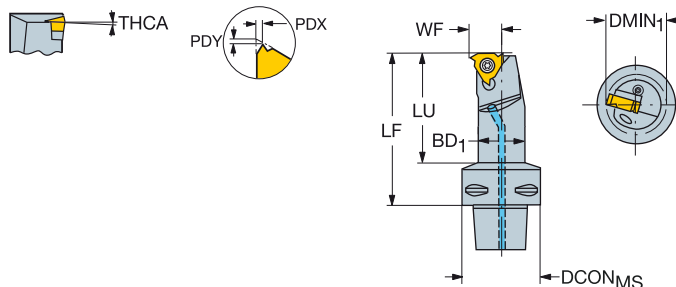

Código para pedido	CZC _{MS}	DMIN ₁	LU	CNSC	Código para pedido	Dimensões, mm							MIID	
						DCON _{MS}	BD	LF	WF	THCA	BAR	NM		KG
16	C3	25.0	44.0	3	C3-266R/LKF-14060-16	32.0	20.0	60.0	14.0	1°	10	3.0	0.24	266.LL-16..
	C4	20.0	37.0	3	C4-266R/LKF-12060-16	40.0	16.0	60.0	12.0	2°	10	3.0	0.35	266.LL-16..
	C4	25.0	38.0	3	C4-266R/LKF-14060-16	40.0	20.0	60.0	14.0	1°	10	3.0	0.38	266.LL-16..
	C4	32.0	48.0	3	C4-266R/LKF-17070-16	40.0	25.0	70.0	17.0	1°	10	3.0	0.45	266.LL-16..
	C4	40.0	69.0	3	C4-266RKF-22090-16	40.0	32.0	90.0	22.0	1°	10	3.0	0.67	266.RL-16..
	C5	25.0	36.0	3	C5-266R/LKF-14060-16	50.0	20.0	60.0	14.0	1°	10	3.0	0.57	266.LL-16..
	C5	32.0	47.0	3	C5-266R/LKF-17070-16	50.0	25.0	70.0	17.0	1°	10	3.0	0.64	266.LL-16..
	C5	40.0	68.0	3	C5-266R/LKF-22090-16	50.0	32.0	90.0	22.0	1°	10	3.0	0.86	266.LL-16..
	C5	50.0	84.0	3	C5-266R/LKF-27105-16	50.0	40.0	105.0	27.0	1°	10	3.0	1.21	266.LL-16..
	C5	20.0	35.0	3	C5-266RKF-12060-16	50.0	16.0	60.0	12.0	2°	10	3.0	0.54	266.RL-16..
	C6	25.0	42.0	3	C6-266R/LKF-14070-16	63.0	20.0	70.0	14.0	1°	10	3.0	0.96	266.LL-16..
	C6	32.0	48.0	3	C6-266R/LKF-17075-16	63.0	25.0	75.0	17.0	1°	10	3.0	1.02	266.LL-16..
	C6	40.0	64.0	3	C6-266R/LKF-22090-16	63.0	32.0	90.0	22.0	1°	10	3.0	1.24	266.LL-16..
	C6	50.0	80.0	3	C6-266R/LKF-27105-16	63.0	40.0	105.0	27.0	1°	10	3.0	1.56	266.LL-16..
22	C4	25.0	42.0	3	C4-266RKF-15065-22	40.0	20.0	65.0	15.0	2°	10	5.0	0.37	266.RL-22..
	C4	32.0	48.0	3	C4-266RKF-19070-22	40.0	25.0	70.0	19.0	1°	10	5.0	0.44	266.RL-22..
	C4	40.0	69.0	3	C4-266RKF-22090-22	40.0	32.0	90.0	22.0	1°	10	5.0	0.65	266.RL-22..
	C4	50.0	60.0	3	C4-266RKF-27080-22	40.0	39.5	80.0	27.0	1°	10	5.0	0.75	266.RL-22..
	C5	50.0	84.0	3	C5-266R/LKF-27105-22	50.0	40.0	105.0	26.9	1°	10	5.0	1.19	266.LL-22..
	C5	25.0	41.0	3	C5-266RKF-15065-22	50.0	20.0	65.0	15.0	2°	10	5.0	0.57	266.RL-22..
	C5	32.0	47.0	3	C5-266RKF-19070-22	50.0	25.0	70.0	19.0	1°	10	5.0	0.63	266.RL-22..
	C5	40.0	68.0	3	C5-266RKF-22090-22	50.0	32.0	90.0	22.0	1°	10	5.0	0.84	266.RL-22..
	C6	50.0	80.0	3	C6-266R/LKF-27105-22	63.0	40.0	105.0	26.9	1°	10	5.0	1.53	266.LL-22..
	C6	32.0	48.0	3	C6-266RKF-19075-22	63.0	25.0	75.0	19.0	1°	10	5.0	1.01	266.RL-22..
	C6	40.0	64.0	3	C6-266RKF-22090-22	63.0	32.0	90.0	22.0	1°	10	5.0	1.21	266.RL-22..

Para valores PDX/PDY - consulte a página da pastilha.

R = versão direita, L = versão esquerda

Para recomendações de penetração, veja a página C77

Ângulo de inclinação (THCA) com diferentes calços, veja a página C75

Código para pedido	Componentes				
	Parafuso da pastilha	Calço versão esquerda	Calço versão direita	Parafuso do calço	Olhal
C3, C4 -266R/LKF-14060-16	5513 020-13	5322 389-11	5322 390-11	5512 032-05	5691 034-01
C4-266R/LKF-12060-16	5513 020-02				5691 034-01
C4-266RKF-22090-16	5513 020-13		5322 390-11	5512 032-05	5691 034-01
C4-266R/LKF-17070-16	5513 020-13	5322 389-11	5322 390-11	5512 032-05	5691 034-01
C5-266R/LKF-12060-16	5513 020-02				5691 034-02
C5, C6 -266R/LKF-14060-16	5513 020-13	5322 389-11	5322 390-11	5512 032-05	5691 034-02
C5, C6 -266R/LKF-17070-16	5513 020-13	5322 389-11	5322 390-11	5512 032-05	5691 034-02
C5, C6 -266R/LKF-22090-16	5513 020-13	5322 389-11	5322 390-11	5512 032-05	5691 034-02
C5, C6 -266R/LKF-27105-16	5513 020-13	5322 389-11	5322 390-11	5512 032-05	5691 034-02
C4-266R/LKF-15065-22	5513 020-07				5691 034-01
C4-266RKF-19070-22	5513 020-26		5322 380-11	5512 032-04	5691 034-01
C4-266RKF-22090-22	5513 020-26		5322 380-11	5512 032-04	5691 034-01
C4-266RKF-27080 -22	5513 020-26		5322 380-11	5512 032-04	5691 034-01
C5-266R/LKF-15065-22	5513 020-07				5691 034-02
C5, C6 -266R/LKF-27105-22	5513 020-26	5322 379-11	5322 380-11	5512 032-04	5691 034-02
C5, C6 -266RKF-19070-22	5513 020-26		5322 380-11	5512 032-04	5691 034-02
C5, C6 -266RKF-22090-22	5513 020-26		5322 380-11	5512 032-04	5691 034-02

Para a lista completa de componentes, acesse www.sandvik.coromant.com



Barra de mandrilar CoroThread® 266 para torneamento de roscas

Fixação por parafuso

Cilíndrica com canal para bucha EasyFix - Refrigeração interna

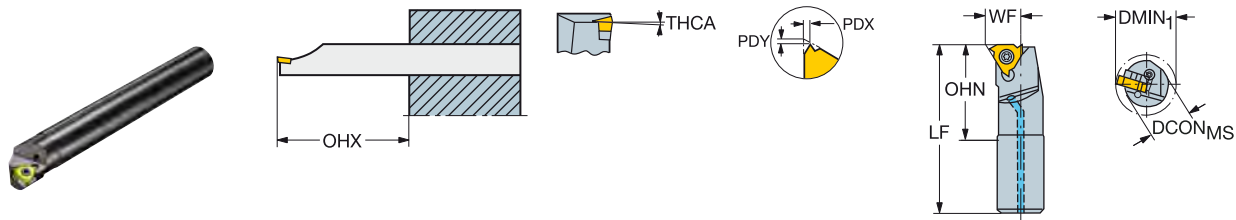

266 R/LL

CZC _{MS}	DMIN ₁	LU	OHX	OHN	CNSC	Código para pedido	Dimensões, mm						MID		
							DCON _{MS}	BD	LF	WF	THCA	BAR		NM	KG
16	16	20.0	48.0	48.0	27.0	266R/LKF-16-16-R	16.0	16.0	125.0	12.0	2°	10	3.0	0.20	266.LL-16..
	20	25.0	60.0	60.0	28.7	266R/LKF-20-16-R	20.0	20.0	140.0	14.0	1°	10	3.0	0.34	266.LL-16..
	25	32.0	75.0	75.0	28.8	266R/LKF-25-16-R	25.0	25.0	180.0	17.0	1°	10	3.0	0.65	266.LL-16..
22	20	25.0	60.0	60.0	34.2	266R/LKF-20-22-R	20.0	20.0	140.0	15.0	2°	10	5.0	0.32	266.LL-22..
	25	32.0	75.0	75.0	34.6	266R/LKF-25-22-R	25.0	25.0	180.0	19.0	1°	10	5.0	0.65	266.LL-22..
16	16	20.0	96.0	96.0	33.2	266R/LKF-16-16-RE	16.0	16.0	200.0	12.0	2°	10	3.0	0.53	266.LL-16..

E = Barra de mandrilar reforçada com metal duro

R = versão direita, L = versão esquerda

Para valores PDX/PDY - consulte a página da pastilha.

Para recomendações de penetração, veja a página C77

Ângulo de inclinação (THCA) com diferentes calços, veja a página C75

CZC _{MS}	Componentes				
	Parafuso	Calço versão esquerda	Calço versão direita	Parafuso do calço	
16	5513 020-02				
16	5513 020-13	5322 389-11	5322 390-11	5512 032-05	
22	5513 020-07				
22	5513 020-26	5322 379-11	5322 380-11	5512 032-04	

Para a lista completa de componentes, acesse www.sandvik.coromant.com



Barra de mandrilar CoroThread® 266 para torneamento de roscas

Fixação por parafuso

Cilíndrica com planos - Refrigeração interna

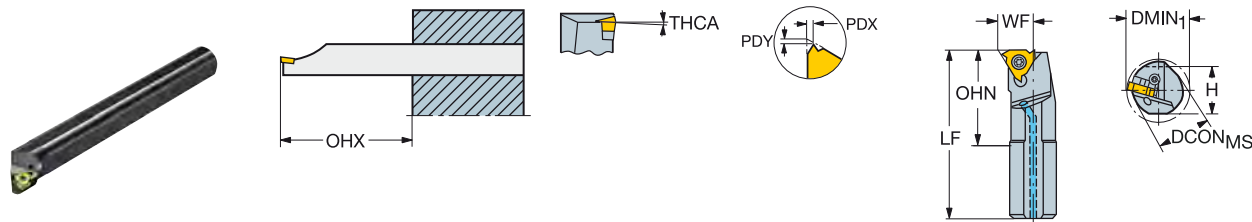

266 R/LL

CZC _{MS}	DMIN ₁	LU	OHX	OHN	CNSC	Código para pedido	Dimensões, mm						MID			
							DCON _{MS}	H	BD	LF	WF	THCA		BAR	NM	KG
16	16	20.0	48.0	48.0	27.0	266R/LKF-16-16	16.0	15.0	16.0	200.0	12.0	2°	10	3.0	0.30	266.LL-16..
	20	25.0	60.0	60.0	29.0	266R/LKF-20-16	20.0	18.0	20.0	250.0	14.0	1°	10	3.0	0.60	266.LL-16..
	25	32.0	75.0	75.0	29.0	266R/LKF-25-16	25.0	23.0	25.0	300.0	17.0	1°	10	3.0	0.97	266.LL-16..
	32	40.0	96.0	96.0	30.9	266R/LKF-32-16	32.0	30.0	32.0	250.0	22.0	1°	10	3.0	1.43	266.LL-16..
	40	50.0	120.0	120.0	31.5	266R/LKF-40-16	40.0	37.0	300.0	27.0	1°	10	3.0	2.59	266.LL-16..	
22	20	25.0	60.0	60.0	35.0	266R/LKF-20-22	20.0	18.0	20.0	250.0	15.0	2°	10	5.0	0.54	266.LL-22..
	25	32.0	75.0	75.0	34.6	266R/LKF-25-22	25.0	23.0	25.0	300.0	19.0	1°	10	5.0	0.96	266.LL-22..
	32	40.0	96.0	96.0	37.7	266R/LKF-32-22	32.0	30.0	32.0	250.0	21.9	1°	10	5.0	1.43	266.LL-22..
	40	50.0	120.0	120.0	38.2	266R/LKF-40-22	40.0	37.0	40.0	300.0	26.9	1°	10	5.0	2.59	266.LL-22..
	50	63.0	150.0	150.0	45.7	266R/LKF-50-22	50.0	47.0	50.0	350.0	34.9	1°	10	5.0	5.26	266.LL-22..
27	40	50.0	120.0	120.0	47.2	266R/LKF-40-27	40.0	37.0	40.0	300.0	26.9	1°	10	7.5	2.55	266.LL-27..

Para valores PDX/PDY - consulte a página da pastilha.

R = versão direita, L = versão esquerda

Para recomendações de penetração, veja a página C77

Ângulo de inclinação (THCA) com diferentes calços, veja a página C75

CZC _{MS}	Componentes				
	Parafuso	Calço versão esquerda	Calço versão direita	Parafuso do calço	
16	5513 020-02				
16	5513 020-13	5322 389-11	5322 390-11	5512 032-05	
22	5513 020-07				
22	5513 020-26	5322 379-11	5322 380-11	5512 032-04	
27	5513 020-66	5322 387-11	5322 388-11	5512 032-03	

Para a lista completa de componentes, acesse www.sandvik.coromant.com



C2



F2



G1



H36



H27



H5

A

Cabeça CoroThread® 266 para torneamento de roscas

Fixação por parafuso

CoroTurn® SL - refrigeração interna

B

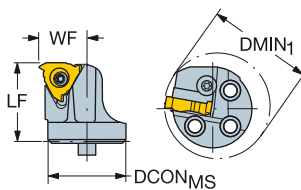

C



266 R/LL

D

CZC _{MS}	DMIN ₁	CNCS	Código para pedido	Dimensões, mm							MIID	
				DCON _{MS}	LF	WF	THCA	BAR	NM	KG		
16	20	25.0	1	SL-266R/LKF-202514-16	20.0	25.0	14.0	2°	10	3.0	0.06	266.LL-16..
25	32.0	1	SL-266R/LKF-252517-16	25.0	25.0	17.0	1°	10	3.0	0.08	266.LL-16..	
32	40.0	1	SL-266R/LKF-323222-16	32.0	32.0	22.0	1°	10	3.0	0.10	266.LL-16..	
40	50.0	1	SL-266R/LKF-403227-16	40.0	32.0	27.0	1°	10	3.0	0.22	266.LL-16..	
22	25	32.0	1	SL-266R/LKF-252819-22	25.0	28.0	19.0	1°	10	5.0	0.09	266.LL-22..
32	40.0	1	SL-266R/LKF-323222-22	32.0	32.0	21.9	1°	10	5.0	0.13	266.LL-22..	
40	50.0	1	SL-266R/LKF-403227-22	40.0	32.0	26.9	1°	10	5.0	0.20	266.LL-22..	
27	40	50.0	1	SL-266R/LKF-403627-27	40.0	36.0	26.9	1°	10	7.5	0.23	266.LL-27..

Para valores PDX/PDY - consulte a página da pastilha.

R = versão direita, L = versão esquerda

Para recomendações de penetração, veja a página C77

Ângulo de inclinação (THCA) com diferentes calços, veja a página C75

E

Componentes					
CZC _{MS}	Parafuso	Calço versão esquerda	Calço versão direita	Parafuso do calço	
16	20	5513 020-02			
16	25-40	5513 020-13	5322 389-11	5322 390-11	5512 032-05
22	25	5513 020-07			
22	32-40	5513 020-26	5322 379-11	5322 380-11	5512 032-04
27	40	5513 020-66	5322 387-11	5322 388-11	5512 032-03

Para a lista completa de componentes, acesse www.sandvik.coromant.com

F

G

H



C2



F2



H36



H27



H5



H2

Cabeça CoroThread® 266 para torneamento de roscas

Fixação por parafuso

CoroTurn® SL Troca Rápida



266 R/LL

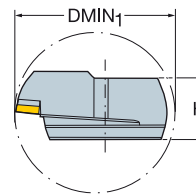
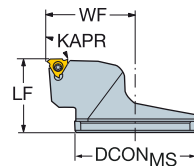
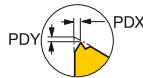

	CZC _{MS}	DMIN ₁	Código para pedido	Dimensões, mm								MIID	
				DCON _{MS}	H	BD	LF	WF	THCA	NM	KG		
	16	80	100.0	SL-266RKF-80-16-QC	80.0	37.5	80.0	45.0	58.5	1°	3.0	0.58	266.RL-16..
	22	80	100.0	SL-266RKF-80-22-QC	80.0	37.5	80.0	45.0	58.5	1°	5.0	0.56	266.RL-22..
	27	80	100.0	SL-266RKF-80-27-QC	80.0	37.5	80.0	45.0	58.5	1°	7.5	0.55	266.RL-27..

Para valores PDX/PDY - consulte a página da pastilha.

R = versão direita

Para recomendações de penetração, veja a página C77

Ângulo de inclinação (THCA) com diferentes calços, veja a página C75

Componentes				
	CZC _{MS}	Parafuso	Calço versão direita	Parafuso do calço
16	80	5513 020-13	5322 390-11	5512 032-05
22	80	5513 020-26	5322 380-11	5512 032-04
27	80	5513 020-66	5322 388-11	5512 032-03

Para a lista completa de componentes, acesse www.sandvik.coromant.com



C2



F2



H36



H27



H2



T-Max® U-Lock

Rosqueamento interno

Aplicação

- Rosqueamento interno

Área de aplicação ISO:



Características e benefícios

- Pastilhas intercambiáveis
- Três arestas de corte vivas para roscas de alta qualidade



T-Max U-Lock® é um complemento ao rígido sistema de rosqueamento de pastilhas intercambiáveis CoroThread 266. Ele fornece uma solução especializada para aplicações de rosqueamento interno de 11 mm (pol.) em duas geometrias diferentes: uso geral e viva.

www.sandvik.coromant.com/tmaxulock

Tipos de pastilhas

Perfil completo

Alta produtividade
Métrica 60°
UN 60°
Whitworth 55°
NPT 60°

Perfil em V

Estoque mínimo de ferramentas
Perfil-V 60° e 55°

Ferramentas

- Unidades de corte Coromant Capto®
- Barras de mandrilar
- Cabeças CoroTurn® SL



- Geometrias e classes de pastilha para todos os materiais
- Pastilhas Tailor Made para quase todos os perfis de roscas e passos

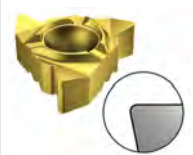

Geometria standard

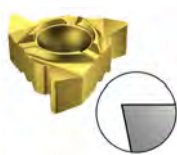

Geometria F viva

Os porta-ferramentas para pastilhas tamanho 11 são feitos para um ângulo de inclinação de 2° e nenhum calço

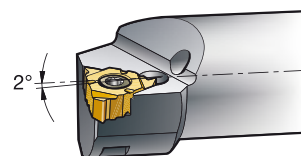

C45



C51



H35

Pastilha T-Max® U-Lock para torneamento de roscas

Perfil em V 60° sem formador de crista

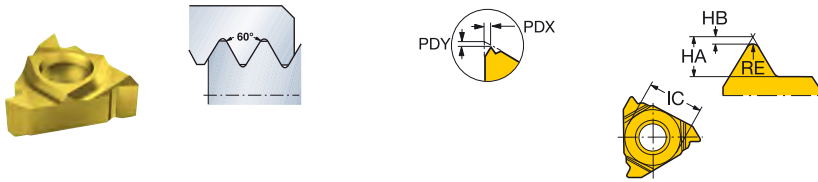

Roscas internas versão direita

						P	M	K	N	S	H	Dimensões, mm										
	TPN	TPX	TPIN	TPIX	NT	Código para pedido						RE	HA	HB	PDX	PDY						
	11	1.0	2.0	12.0	24.0	1	R166.0L-11VM01-001	★	☆	★	☆	★	☆	★	☆	★	☆	0.06	1.45	0.06	0.90	0.68
		1.0	2.0	12.0	24.0	1	R166.0L-11VM01C001	★	★	★	★	★	★	★	★	★	★	0.06	1.45	0.06	0.90	0.68

Roscas internas versão esquerda

						P	M	K	N	S	H	Dimensões, mm										
	TPN	TPX	TPIN	TPIX	NT	Código para pedido						RE	HA	HB	PDX	PDY						
	11	1.0	2.0	12.0	24.0	1	L166.0L-11VM01-001	★	★	★	★	★	★	★	★	★	★	0.06	1.45	0.06	0.90	0.06

R = versão direita, L = versão esquerda



A

TORNEAMENTO DE ROSCAS

Pastilhas

Pastilha T-Max® U-Lock para torneamento de roscas

Perfil em V 55° sem formador de crista

B

C

Roscas internas versão direita

TPIN	TPIX	NT	Código para pedido	P		M		K		N		S		H		Dimensões, mm					
				1020	4125	1020	4125	1020	4125	1020	4125	1020	4125	1020	4125	RE	HA	HB	PDX	PDY	
11	14.0	28.0	1	R166.0L-11VW01-001	★	☆	★	☆	★	☆	★	☆	★	☆	★	☆	0.11	1.60	0.12	0.95	0.68

Roscas internas versão esquerda

TPIN	TPIX	NT	Código para pedido	P		M		K		N		S		H		Dimensões, mm				
				1020	4125	1020	4125	1020	4125	1020	4125	1020	4125	RE	HA	HB	PDX	PDY		
11	14.0	28.0	1	L166.0L-11VW01-001	★	★	★	★	★	★	★	★	★	★	★	0.11	1.60	0.12	0.95	0.12

R = versão direita, L = versão esquerda

E

F

G

H

C 46

Pastilha T-Max® U-Lock para torneamento de roscas

Métrica 60° Perfil completo

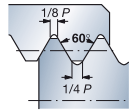
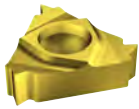

STDNO
TCTR

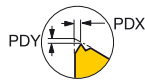

ISO 965-1998
IT 6

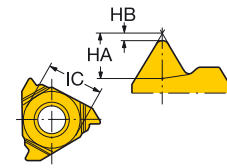

Roscas internas versão direita

TP	NT	Código para pedido	P		M		K		N		S		H		Dimensões, mm			
			1020	4125	1020	4125	1020	4125	1020	4125	1020	4125	1020	4125	HA	HB	PDX	PDY
11	0.50	1	R166.OL-11MM01-050	★	★	★	★	★	★	★	★	★	★	★	0.32	0.03	0.50	0.68
	0.75	1	R166.OL-11MM01-075	★	★	★	★	★	★	★	★	★	★	★	0.47	0.04	0.60	0.68
	1.00	1	R166.OL-11MM01-100	★	★	★	★	★	★	★	★	★	★	★	0.64	0.06	0.80	0.68
	1.25	1	R166.OL-11MM01-125	★	★	★	★	★	★	★	★	★	★	★	0.79	0.07	0.80	0.68
	1.50	1	R166.OL-11MM01-150	★	★	★	★	★	★	★	★	★	★	★	0.96	0.09	1.10	0.68
	1.75	1	R166.OL-11MM01-175	★	★	★	★	★	★	★	★	★	★	★	1.11	0.11	1.05	0.68
	2.00	1	R166.OL-11MM01-200	★	★	★	★	★	★	★	★	★	★	★	1.27	0.12	0.92	0.58

Roscas internas versão esquerda

TP	NT	Código para pedido	P		M		K		N		S		H		Dimensões, mm			
			1020	4125	1020	4125	1020	4125	1020	4125	1020	4125	1020	4125	HA	HB	PDX	PDY
11	0.50	1	L166.OL-11MM01-050	★	★	★	★	★	★	★	★	★	★	★	0.32	0.03	0.50	0.68
	0.75	1	L166.OL-11MM01-075	★	★	★	★	★	★	★	★	★	★	★	0.47	0.04	0.60	0.68
	1.00	1	L166.OL-11MM01-100	★	★	★	★	★	★	★	★	★	★	★	0.64	0.06	0.85	0.68
	1.25	1	L166.OL-11MM01-125	★	★	★	★	★	★	★	★	★	★	★	0.79	0.07	0.90	0.68
	1.50	1	L166.OL-11MM01-150	★	★	★	★	★	★	★	★	★	★	★	0.96	0.09	1.00	0.68
	1.75	1	L166.OL-11MM01-175	★	★	★	★	★	★	★	★	★	★	★	1.11	0.11	1.05	0.68
	2.00	1	L166.OL-11MM01-200	★	★	★	★	★	★	★	★	★	★	★	1.27	0.12	0.92	0.58

R = versão direita, L = versão esquerda



C51



C73



C83



H36



H35



Pastilha T-Max® U-Lock para torneamento de roscas

UN 60° Perfil completo

STDNO
TCTR

ISO 5864-1978
2B

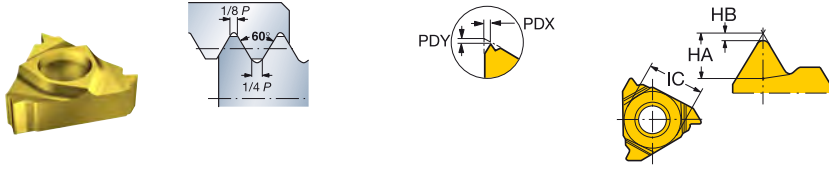

Roscas internas versão direita

TPI	NT	Código para pedido	P	M	K	N	S	H	Dimensões, mm				
			1020	1020	1020	1020	1020	HA	HB	PDX	PDY		
11	32.0	1	R166.0L-11UN01-320	★	★	★	★	★	☆	0.50	0.04	0.60	0.68
	28.0	1	R166.0L-11UN01-280	★	★	★	★	★	☆	0.58	0.05	0.80	0.68
	24.0	1	R166.0L-11UN01-240	★	★	★	★	★	☆	0.67	0.06	0.85	0.68
	20.0	1	R166.0L-11UN01-200	★	★	★	★	★	☆	0.80	0.07	0.90	0.68
	18.0	1	R166.0L-11UN01-180	★	★	★	★	★	☆	0.89	0.08	1.00	0.68
	16.0	1	R166.0L-11UN01-160	★	★	★	★	★	☆	1.00	0.09	1.00	0.68
	14.0	1	R166.0L-11UN01-140	★	★	★	★	★	☆	1.13	0.11	1.05	0.68

Roscas internas versão esquerda

TPI	NT	Código para pedido	P	M	K	N	S	H	Dimensões, mm				
			1020	1020	1020	1020	1020	HA	HB	PDX	PDY		
11	32.0	1	L166.0L-11UN01-320	★	★	★	★	★	☆	0.50	0.04	0.60	0.68
	28.0	1	L166.0L-11UN01-280	★	★	★	★	★	☆	0.58	0.05	0.80	0.68
	24.0	1	L166.0L-11UN01-240	★	★	★	★	★	☆	0.67	0.06	0.85	0.68
	20.0	1	L166.0L-11UN01-200	★	★	★	★	★	☆	0.80	0.07	0.90	0.68
	18.0	1	L166.0L-11UN01-180	★	★	★	★	★	☆	0.89	0.08	1.00	0.68
	16.0	1	L166.0L-11UN01-160	★	★	★	★	★	☆	1.00	0.09	1.00	0.68
	14.0	1	L166.0L-11UN01-140	★	★	★	★	★	☆	1.13	0.11	1.05	0.68

R = versão direita, L = versão esquerda



A

TORNEAMENTO DE ROSCAS

Pastilhas

Pastilha T-Max® U-Lock para torneamento de roscas

NPT 60° (NPSC, NPTR, LINE PIPE) perfil completo

B

STDNO

ANSI B.1.20.1-1983

C

Roscas internas versão direita

TPI	NT	Código para pedido	P	M	K	N	S	H	Dimensões, mm					
			1020	1020	1020	1020	1020	1020	HA	HB	PDX	PDY	TG	
11	18.0	1	R166.0L-11NT01F180	★	★	★	★	★	★	1.14	0.08	0.85	0.67	0.06
	14.0	1	R166.0L-11NT01F140	★	★	★	★	★	★	1.46	0.09	0.95	0.67	0.06

A pastilha pode gerar um truncamento ligeiramente maior para ÓLEODUTO 14 t.p.i

R = versão direita

D

E

F

G

H

C51

C73

C83

H36

H35

C 50

Unidade de corte T-Max® U-Lock para torneamento de roscas

Fixação por parafuso

Coromant Capto® - Refrigeração interna

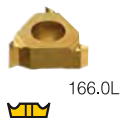
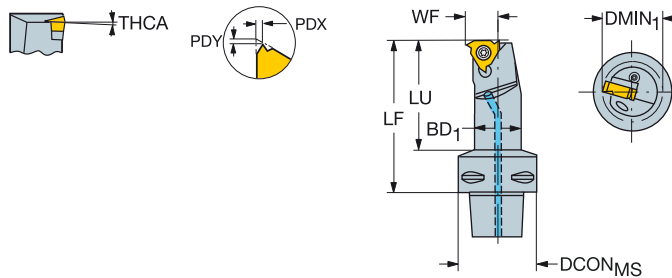

	CZC _{MS}	DMIN ₁	LU	CNSC	Código para pedido	Dimensões, mm							MIID		
						DCON _{MS}	BD	LF	WF	THCA	BAR	NM		KG	
	11	C3	20.0	33.0	3	C3-R166.0KF-12050-11	32.0	16.0	50.0	12.0	1°	10	0.9	0.20	R166.0L-11..
		C4	20.0	37.0	3	C4-R166.0KF-12060-11	40.0	16.0	60.0	12.0	1°	10	0.9	0.34	R166.0L-11..
	11	C4	20.0	37.0	3	C4-R166.0KFZ12060-11	40.0	16.0	60.0	12.0	1°	10	0.9	0.34	R166.0L-11..

Para valores PDX/PDY - consulte a página da pastilha.

Para recomendações de penetração, veja a página C77

Ângulo de inclinação (THCA) com diferentes calços, veja a página C75

Z = Para montagem invertida

R = versão direita

Componentes
Parafuso da pastilha
5513 020-03

Para a lista completa de componentes, acesse www.sandvik.coromant.com



A

Barra de mandrilar inteiriça de metal duro T-Max® U-Lock para torneamento de roscas

Fixação por parafuso

Cilíndrica com canal para bucha EasyFix - Refrigeração interna

B

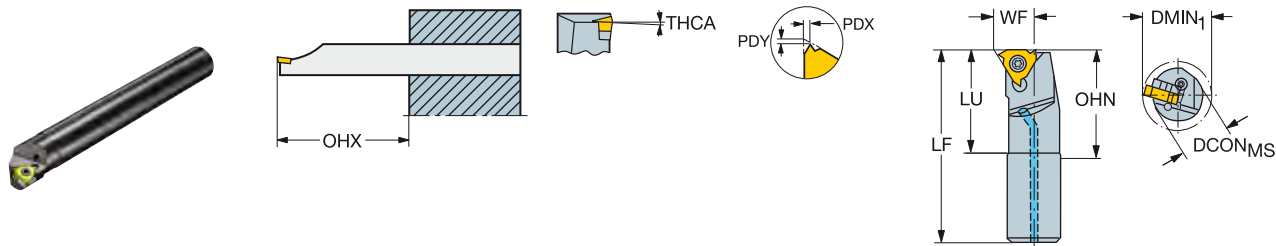

C

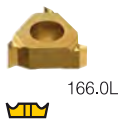

Código para pedido	Dimensões, mm							Dimensões, mm			Dimensões, mm			MID	
	CZC _{MS}	DMIN ₁	LU	OHX	OHN	CNSC	DCON _{MS}	BD	LF	WF	THCA	BAR	NM		KG
R166.0KF-10E-11	10	12.0	60.0	60.0	21.0	1	10.0	10.0	150.0	7.2	1°	10	0.9	0.15	R166.0L-11..
R166.0KF-12E-11	12	16.0	72.0	72.0	25.0	1	12.0	12.0	180.0	9.0	1°	10	0.9	0.03	R166.0L-11..

D

Para valores PDX/PDY - consulte a página da pastilha.

Para recomendações de penetração, veja a página C77

Ângulo de inclinação (THCA) com diferentes calços, veja a página C75

R = versão direita

Componentes

Parafuso da pastilha
5513 020-03

Para a lista completa de componentes, acesse www.sandvik.coromant.com

F

G

H



Barra de mandrilar T-Max® U-Lock para torneamento de roscas

Fixação por parafuso
Cilíndrica com planos

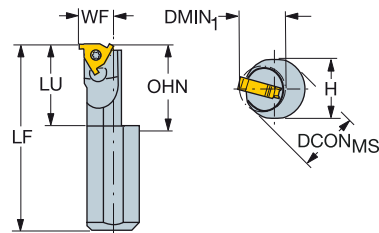
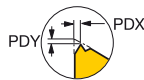
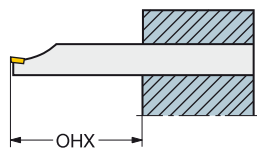

166.0L



	Dimensões, mm						Dimensões, mm						MIID			
	CZC _{MS}	DMIN ₁	LU	OHX	OHN	Código para pedido	DCON _{MS}	H	BD	LF	WF	THCA		NM	KG	
	11	16	12.0	20.9	48.0	20.9	R/L166.0KF-16-1220-11B	16.0	15.0	12.0	125.0	10.0	1°	0.9	0.19	L166.0L-11..
		16	16.0	25.9	48.0	25.9	R/L166.0KF-16-1625-11B	16.0	15.0	16.0	150.0	10.5	1°	0.9	0.23	L166.0L-11..

Para valores PDX/PDY - consulte a página da pastilha.

R = versão direita, L = versão esquerda

Para recomendações de penetração, veja a página C77

Ângulo de inclinação (THCA) com diferentes calços, veja a página C75

Componentes
Parafuso da pastilha
5513 020-03

Para a lista completa de componentes, acesse www.sandvik.coromant.com



Cabeça T-Max® U-Lock para torneamento de roscas

Fixação por parafuso

CoroTurn® SL - Refrigeração interna

B

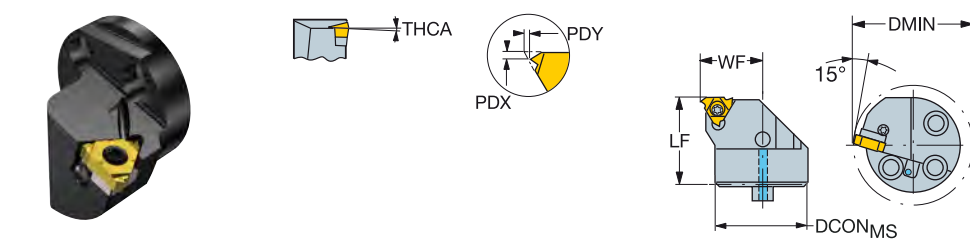

C

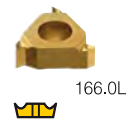

		Dimensões, mm											
		CZC _{MS}	DMIN ₁	CNSC	Código para pedido	DCON _{MS}	LF	WF	THCA	BAR	NM	KG	MIID
	11	16	20.0	1	R/L566.0KFC-162012-11	16.0	20.0	12.0	1°	10	0.9	0.03	L166.0L-11..
		20	25.0	1	R/L566.0KFC-202014-11	20.0	20.0	14.0	1°	10	0.9	0.04	L166.0L-11..

D

Para valores PDX/PDY - consulte a página da pastilha. R = versão direita, L = versão esquerda
 Para recomendações de penetração, veja a página C77
 Ângulo de inclinação (THCA) com diferentes calços, veja a página C75

Componentes
Parafuso da pastilha
5513 020-03

E

Para a lista completa de componentes, acesse www.sandvik.coromant.com

F

G

H



CoroCut® XS

Para usinagem externa de peças pequenas e delgadas

Aplicação

- Corte
- Rosqueamento externo
- Canais externos
- Torneamento

Área de aplicação ISO:



Características e benefícios

- Alta precisão
- Tolerâncias estreitas
- Boa acessibilidade ao trocar as pastilhas
- Ampla variedade de larguras de pastilhas
- Arestas de corte vivas
- Todas as pastilhas se adaptam ao mesmo porta-ferramentas
- Suportes e pastilhas retificadas de alta qualidade
- Pastilhas de perfil completo para roscas de alta qualidade em uma operação
- Desenvolvido para manter o porta-ferramenta intacto caso a pastilha quebre.
- Disponível com refrigeração de alta precisão



www.sandvik.coromant.com/corocutxs

Suportes

Suportes dedicados para cortes próximos ao subspindle estão disponíveis com haste quadrada de alta precisão.

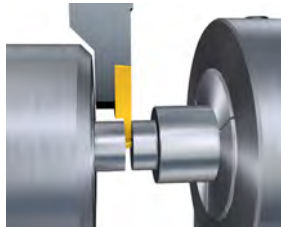

Pastilhas

Torneamento	Torneamento reverso	Corte	Canais	Perfilamento	Rosqueamento
A277	A277	B97	B117	B121	C56

Ferramentas

Ferramenta convencional QST™	Cabeças de corte CoroTurn® SL
B99	B100

A

TORNEAMENTO DE ROSCAS

Pastilhas

Pastilha CoroCut® XS para torneamento de roscas

Perfil em V 60° sem formador de crista

B

C

Roscas externas versão direita

SSC	TPN	TPX	TPIN	TPIX	NT	Código para pedido	P			M			K			N			S			0			Dimensões, mm					
							1025	1105	H13A	1025	1105	H13A	1025	1105	H13A	1025	1105	H13A	1025	1105	H13A	1025	1105	H13A	RE	HA	HB	PDX		
3	0.4	1.0	24.0	72.0	1	MATR 3 60-A	☆	★	☆	☆	★	☆	☆	★	☆	☆	★	☆	☆	★	☆	☆	★	☆	☆	★	0.05	0.75	0.05	0.60
	0.4	1.0	24.0	72.0	1	MATR 3 60-C	☆	★	☆	☆	★	☆	☆	★	☆	☆	★	☆	☆	★	☆	☆	★	☆	☆	★	0.05	0.75	0.05	0.60
	0.4	2.0	12.0	72.0	1	MATR 3 60-N	☆	★	☆	☆	★	☆	☆	★	☆	☆	★	☆	☆	★	☆	☆	★	☆	☆	★	0.05	1.50	0.05	1.59

D

Roscas externas versão esquerda

SSC	TPN	TPX	TPIN	TPIX	NT	Código para pedido	P			M			K			N			S			0			Dimensões, mm					
							1025	1105	H13A	1025	1105	H13A	1025	1105	H13A	1025	1105	H13A	1025	1105	H13A	1025	1105	H13A	RE	HA	HB	PDX		
3	0.4	1.0	24.0	72.0	1	MATL 3 60-A	☆	★	☆	☆	★	☆	☆	★	☆	☆	★	☆	☆	★	☆	☆	★	☆	☆	★	0.05	0.75	0.05	0.60
	0.4	1.0	24.0	72.0	1	MATL 3 60-C	☆	★	☆	☆	★	☆	☆	★	☆	☆	★	☆	☆	★	☆	☆	★	☆	☆	★	0.05	0.75	0.05	0.60
	0.4	2.0	12.0	72.0	1	MATL 3 60-N	☆	★	☆	☆	★	☆	☆	★	☆	☆	★	☆	☆	★	☆	☆	★	☆	☆	★	0.05	1.50	0.05	1.59

E

SSC = Para corresponder ao SSC na ferramenta.

R = versão direita, L = versão esquerda

F

G

H

C 56

Pastilha CoroCut® XS para torneamento de roscas

Métrica 60° perfil completo

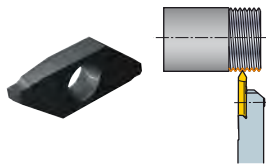

STDNO
TCTR

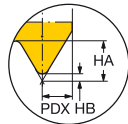

ISO 965-1998
IT 6

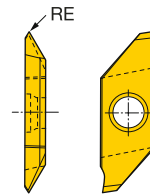

Roscas externas versão direita

SSC	TP	NT	Código para pedido	Dimensões, mm								
				P	M	N	S	O				
				1105	1105	1105	1105	1105	RE	HA	HB	PDX
3	0.20	1	MATR 3-MM01F-020-A	*	*	*	*	*	0.03	0.14	0.02	0.23
	0.25	1	MATR 3-MM01F-025-A	*	*	*	*	*	0.04	0.18	0.03	0.28
	0.30	1	MATR 3-MM01F-030-A	*	*	*	*	*	0.04	0.22	0.03	0.28
	0.35	1	MATR 3-MM01F-035-A	*	*	*	*	*	0.05	0.25	0.04	0.32
	0.40	1	MATR 3-MM01F-040-A	*	*	*	*	*	0.06	0.29	0.04	0.38
	0.45	1	MATR 3-MM01F-045-A	*	*	*	*	*	0.06	0.32	0.05	0.38
	0.50	1	MATR 3-MM01F-050-A	*	*	*	*	*	0.07	0.36	0.05	0.48
	0.70	1	MATR 3-MM01F-070-A	*	*	*	*	*	0.10	0.51	0.08	0.38
	0.75	1	MATR 3-MM01F-075-A	*	*	*	*	*	0.11	0.54	0.08	0.38
	0.80	1	MATR 3-MM01F-080-A	*	*	*	*	*	0.11	0.58	0.09	0.38
	1.00	1	MATR 3-MM01F-100-A	*	*	*	*	*	0.12	0.72	0.11	0.38
	1.25	1	MATR 3-MM01F-125-A	*	*	*	*	*	0.15	0.90	0.14	0.38
	1.50	1	MATR 3-MM01F-150-A	*	*	*	*	*	0.22	1.08	0.16	0.38

Roscas externas versão esquerda

SSC	TP	NT	Código para pedido	Dimensões, mm								
				P	M	N	S	O				
				1105	1105	1105	1105	1105	RE	HA	HB	PDX
3	0.40	1	MATL 3-MM01F-040-A	*	*	*	*	*	0.06	0.29	0.04	0.38
	0.50	1	MATL 3-MM01F-050-A	*	*	*	*	*	0.07	0.36	0.05	0.38
	0.70	1	MATL 3-MM01F-070-A	*	*	*	*	*	0.10	0.51	0.08	0.38
	0.75	1	MATL 3-MM01F-075-A	*	*	*	*	*	0.11	0.54	0.08	0.38
	0.80	1	MATL 3-MM01F-080-A	*	*	*	*	*	0.11	0.58	0.09	0.38
	1.00	1	MATL 3-MM01F-100-A	*	*	*	*	*	0.12	0.72	0.11	0.38
	1.25	1	MATL 3-MM01F-125-A	*	*	*	*	*	0.15	0.90	0.14	0.38
	1.50	1	MATL 3-MM01F-150-A	*	*	*	*	*	0.22	1.08	0.16	0.38

SSC = Para corresponder ao SSC na ferramenta.

R = versão direita, L = versão esquerda



B99



B136



C83



H36



H24



A

Pastilha CoroCut® XS para torneamento de roscas

UN 60° Perfil completo

B

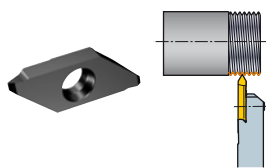

STDNO
TCTR

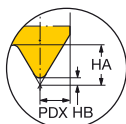

ISO 5864-1978
2A

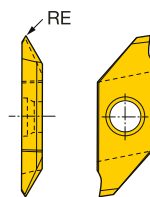

Roscas externas versão direita

C

SSC	TPI	NT	Código para pedido	P	M	N	S	O	Dimensões, mm			
				1105	1105	1105	1105	1105	RE	HA	HB	PDX
3	80.0	1	MATR 3-UN01F-800-A	*	*	*	*	*	0.04	0.22	0.04	0.38
	72.0	1	MATR 3-UN01F-720-A	*	*	*	*	*	0.05	0.27	0.05	0.38
	64.0	1	MATR 3-UN01F-640-A	*	*	*	*	*	0.06	0.31	0.06	0.38
	56.0	1	MATR 3-UN01F-560-A	*	*	*	*	*	0.06	0.35	0.06	0.38
	48.0	1	MATR 3-UN01F-480-A	*	*	*	*	*	0.07	0.38	0.07	0.38
	40.0	1	MATR 3-UN01F-400-A	*	*	*	*	*	0.09	0.51	0.09	0.38
	32.0	1	MATR 3-UN01F-320-A	*	*	*	*	*	0.10	0.59	0.10	0.38

Whitworth 55° (BSW, BSF, BSP) Perfil completo

D

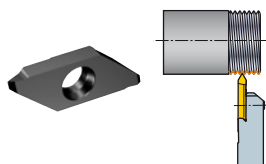

STDNO
STDNO
STDNO
TCTR

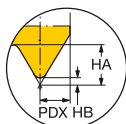

ISO 228-1982
BS-2779-1973
BS 84-1955
CLASS A

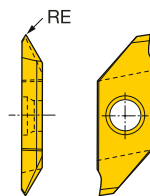

Roscas externas versão direita

E

SSC	TPI	NT	Código para pedido	P	M	N	S	O	Dimensões, mm			
				1105	1105	1105	1105	1105	RE	HA	HB	PDX
3	28.0	1	MATR 3-WH01F-280-A	*	*	*	*	*	0.13	0.72	0.13	0.38
	19.0	1	MATR 3-WH01F-190-A	*	*	*	*	*	0.19	1.06	0.19	0.38

NPT 60° (NPSC, NPTR, LINE PIPE) perfil completo

F

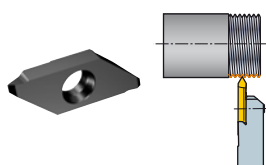

STDNO

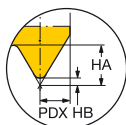

ANSI B.1.20.1-1983

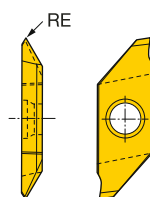

Roscas externas versão direita

G

SSC	TPI	NT	Código para pedido	P	M	N	S	O	Dimensões, mm			
				1105	1105	1105	1105	1105	RE	HA	HB	PDX
3	27.0	1	MATR 3-NT01F-270-A	*	*	*	*	*	0.05	0.76	0.05	0.38
	18.0	1	MATR 3-NT01F-180-A	*	*	*	*	*	0.08	1.14	0.08	0.38
	14.0	1	MATR 3-NT01F-140-A	*	*	*	*	*	0.09	1.46	0.09	0.38

SSC = Para corresponder ao SSC na ferramenta.

R = versão direita

H



B99



B136



C83



H36



H24

CoroTurn® XS

Torneamento interno, usinagem de canais frontais e rosqueamento de peças pequenas

Aplicação

- Torneamento interno
- Cópia
- Mandrilamento reverso
- Perfilamento
- Canais
- Canais frontais
- Pré-corte
- Rosqueamento

Área de aplicação ISO:



Características e benefícios

- Otimizado para usinagem de alta qualidade de pequenas características
- Alta precisão e repetibilidade
- Sistema de fixação confiável e fácil de usar
- Ferramentas retificadas com precisão para alta repetibilidade
- Aumento da vida útil da ferramenta devido à minimização das microvibrações com adaptadores de hastes de metal duro cilíndricas
- A porca de fixação garante a troca rápida da ferramenta de corte com adaptadores de hastes de metal duro cilíndricas

www.sandvik.coromant.com/coroturnxs

Refrigeração interna

- Os adaptadores foram desenvolvidos com refrigeração interna de precisão.
- Direção selecionável da refrigeração para melhor escoamento de cavacos e usinagem segura.



Precisão de trava

Localização precisa na barra de mandrilar devido ao pino de localização.



Ferramentas de corte

Torneamento	Mandrilament o reverso	Pré-corte	Canais	Canais frontais	Perfilamento	Rosqueamento
A272	A271	B116	B117	B120	B121	C60

Adaptadores

Coromant Capto®	Haste retangular	Haste cilíndrica com plano
F22	F33	F42

Ferramenta inteiraça de metal duro CoroTurn® XS para torneamento de roscas

Perfil em V 60° sem formador de crista

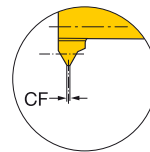
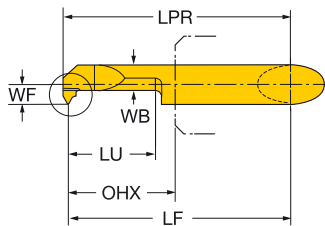
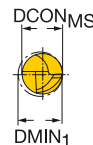
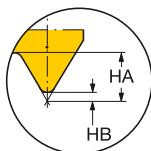

Roscas internas versão direita

CZC _{MS}	TPN	TPX	TPIN	TPIX	DMIN ₁	LU	OHX	Código para pedido	P	M	N	S	H	Dimensões, mm								
									1025	1025	1025	1025	7015	DCON _{MS}	WB	CF	LPR	LF	WF	HA	HB	
	4	0.50	0.70	36.0	48.0	4.2	15.0	17.6	CXS-04TH050VM-4215R	*	*	*	*		4	3.0	0.1	32.7	32.3	2.0	0.5	0.1
	5	0.50	0.75	36.0	48.0	5.2	15.0	17.6	CXS-05TH050VM-5215R	*	*	*	*		5	3.8	0.1	37.7	37.3	2.5	0.5	0.1
	5	0.75	1.00	24.0	36.0	5.1	15.0	17.6	CXS-05TH070VM-5115R	*	*	*	*		5	3.7	0.1	37.8	37.3	2.4	0.7	0.1
	5	1.00	1.25	20.0	24.0	4.8	15.0	17.5	CXS-05TH100VM-4815R	*	*	*	*		5	3.6	0.1	37.9	37.3	2.3	0.8	0.1
	6	1.00	1.25	20.0	24.0	6.2	15.0	17.5	CXS-06TH100VM-6215R	*	*	*	*	*	6	3.6	0.1	37.9	37.3	3.0	0.8	0.1
	6	1.25	1.50	18.0	20.0	6.2	15.0	17.2	CXS-06TH125VM-6215R	*	*	*	*	*	6	3.6	0.2	38.1	37.3	3.0	1.0	0.1
	6	1.50	1.75	16.0	18.0	6.2	15.0	17.2	CXS-06TH150VM-6215R	*	*	*	*	*	6	3.6	0.2	38.3	37.3	3.0	1.1	0.2

Roscas internas versão esquerda

CZC _{MS}	TPN	TPX	TPIN	TPIX	DMIN ₁	LU	OHX	Código para pedido	P	M	N	S	H	Dimensões, mm								
									1025	1025	1025	1025	7015	DCON _{MS}	WB	CF	LPR	LF	WF	HA	HB	
	4	0.50	0.70	36.0	48.0	4.2	15.0	17.6	CXS-04TH050VM-4215L	*	*	*	*		4	3.0	0.1	32.7	32.3	2.0	0.5	0.1
	5	1.00	1.25	20.0	24.0	4.8	15.0	17.5	CXS-05TH100VM-4815L	*	*	*	*		5	3.6	0.1	37.9	37.3	2.3	0.8	0.1
	6	1.00	1.25	20.0	24.0	6.2	15.0	17.5	CXS-06TH100VM-6215L	*	*	*	*		6	3.6	0.1	37.9	37.3	3.0	0.8	0.1
	6	1.25	1.50	18.0	20.0	6.2	15.0	17.2	CXS-06TH125VM-6215L	*	*	*	*	*	6	3.6	0.2	38.1	37.3	3.0	1.0	0.1
	6	1.50	1.75	16.0	18.0	6.2	15.0	17.2	CXS-06TH150VM-6215L	*	*	*	*	*	6	3.6	0.2	38.3	37.3	3.0	1.1	0.2

CZC_{MS} para corresponder com CZC_{WS} no adaptador.

R = versão direita, L = versão esquerda



F2



B135



C83



H36

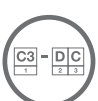

H22

Ferramenta inteiriça de metal duro CoroTurn® XS para torneamento de roscas

Métrica 60° Perfil completo

TCTR IT 6
STDNO ISO 956-1998

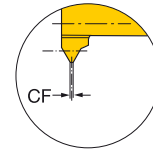
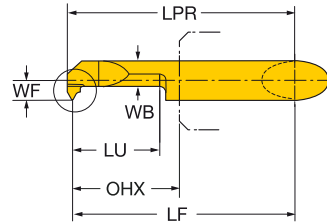
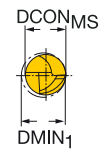
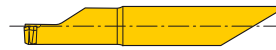
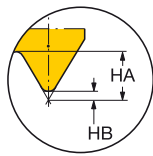

Roscas internas versão direita

CZC _{MS}	TP	DMIN ₁	LU	OHX	Código para pedido	Dimensões, mm			DCON _{MS}	WB	CF	LPR	LF	WF	HA	HB	
						P	M	S									
						1025	1025	1025									
	4	0.5	4.2	15.0	17.6	CXS-04TH050MM-4215R	*	*	*	4	3.5	0.1	32.7	32.3	2.0	0.5	0.1
	4	0.7	4.2	15.0	17.5	CXS-04TH070MM-4215R	*	*	*	4	3.3	0.1	32.8	32.3	1.9	0.8	0.1
	4	0.8	4.0	15.0	17.5	CXS-04TH080MM-4015R	*	*	*	4	3.0	0.1	32.8	32.3	1.9	0.8	0.1
	5	0.5	5.2	15.0	17.6	CXS-05TH050MM-5215R	*	*	*	5	4.5	0.1	37.7	37.3	2.5	0.5	0.1
	5	0.8	5.1	15.0	17.5	CXS-05TH075MM-5115R	*	*	*	5	4.2	0.1	37.8	37.3	2.4	0.8	0.1
	5	1.0	4.8	15.0	17.4	CXS-05TH100MM-4815R	*	*	*	5	3.6	0.1	37.9	37.3	2.3	1.0	0.1
	6	1.0	6.2	15.0	17.4	CXS-06TH100MM-6215R	*	*	*	6	5.1	0.1	37.9	37.3	3.0	1.0	0.1
	6	1.3	6.2	15.0	17.3	CXS-06TH125MM-6215R	*	*	*	6	4.8	0.2	38.0	37.3	3.0	1.3	0.1
	6	1.5	6.2	15.0	17.2	CXS-06TH150MM-6215R	*	*	*	6	4.5	0.2	38.1	37.3	3.0	1.6	0.2
	6	1.8	6.2	15.0	17.1	CXS-06TH175MM-6215R	*	*	*	6	4.3	0.2	38.2	37.3	3.0	1.8	0.2
	6	2.0	6.2	15.0	17.0	CXS-06TH200MM-6215R	*	*	*	6	4.1	0.3	38.3	37.3	3.0	2.1	0.2

CZC_{MS} para corresponder com CZC_{WS} no adaptador.

R = versão direita



F2



B135



C83



H36



H22

Ferramenta inteiraça de metal duro CoroTurn® XS para torneamento de roscas

UN 60° Perfil completo

TCTR 2B
STDNO ISO 5864-1978

B

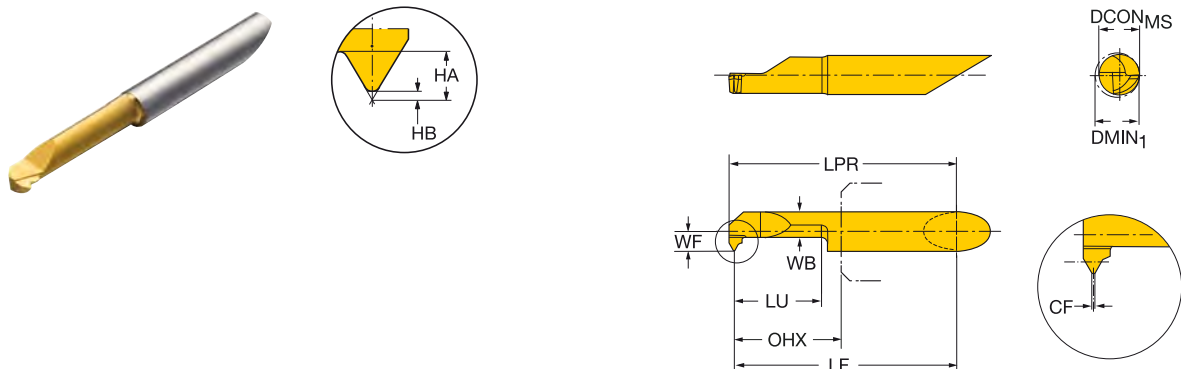

C

Roscas internas versão direita

	CZC _{MS}	TPI	DMIN ₁	LU	OHX	Código para pedido	P M N S			Dimensões, mm							
							1025	1025	1025	DCON _{MS}	WB	CF	LPR	LF	WF	HA	HB
	4	32.0	4.0	15.0	17.5	CXS-04TH320UN-4015R	★	★	★	4	3.0	0.1	32.9	32.3	1.9	0.9	0.1
	4	28.0	4.0	15.0	17.4	CXS-04TH280UN-4015R	★	★	★	4	3.0	0.1	32.9	32.3	1.9	0.9	0.1
	4	24.0	4.2	15.0	17.4	CXS-04TH240UN-4215R	★	★	★	4	3.1	0.1	33.0	32.3	2.0	1.0	0.1
	5	20.0	5.2	15.0	17.3	CXS-05TH200UN-5215R	★	★	★	5	4.0	0.2	38.0	37.3	2.5	1.1	0.1
	6	18.0	6.2	15.0	17.3	CXS-06TH180UN-6215R	★	★	★	6	4.9	0.2	38.1	37.3	3.0	1.3	0.2
	6	16.0	6.2	15.0	15.2	CXS-06TH160UN-6215R	★	★	★	6	4.8	0.2	38.2	37.3	3.0	1.4	0.2

CZC_{MS} para corresponder com CZC_{WS} no adaptador.

R = versão direita

E

F

G

H

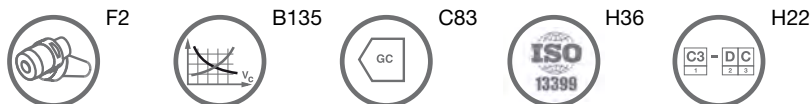

Ferramenta inteiraça de metal duro CoroTurn® XS para torneamento de roscas

Whitworth 55° (BSW, BSF, BSP) Perfil completo

TCTR CLASS A
 STDNO ISO 228-1982
 STDNO BS 2779-1973
 STDNO BS 84-1956

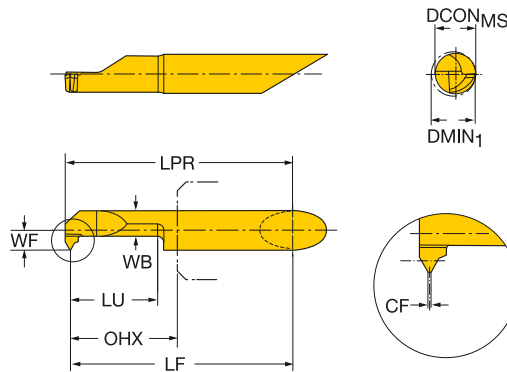
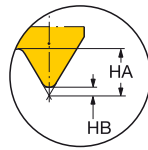

Roscas internas versão direita

CZC _{MS}	TPI	DMIN ₁	LU	RE	OHX	Código para pedido	P	M	N	S	Dimensões, mm						
							1025	1025	1025	1025	DCON _{MS}	WB	LPR	LF	WF	HA	HB
							*	*	*	*							
5	28.0	5.2	15.0	0.120	17.2	CXS-05TH28WH-5215R	*	*	*	*	5	3.8	38.1	37.3	2.5	0.7	0.1
5	26.0	5.2	15.0	0.150	17.2	CXS-05TH26WH-5215R	*	*	*	*	5	3.8	38.1	37.3	2.5	0.8	0.2
5	24.0	5.2	15.0	0.150	17.2	CXS-05TH24WH-5215R	*	*	*	*	5	3.8	38.1	37.3	2.5	0.9	0.2
6	28.0	6.2	15.0	0.120	17.2	CXS-06TH28WH-6215R	*	*	*	*	6	4.0	38.1	37.3	3.0	0.7	0.1
6	22.0	6.2	15.0	0.160	17.0	CXS-06TH22WH-6215R	*	*	*	*	6	4.0	38.3	37.3	3.0	0.9	0.2
6	20.0	6.2	15.0	0.170	17.0	CXS-06TH20WH-6215R	*	*	*	*	6	4.0	38.3	37.3	3.0	1.0	0.2
6	19.0	6.2	15.0	0.180	17.0	CXS-06TH19WH-6215R	*	*	*	*	6	4.0	38.3	37.3	3.0	1.1	0.2

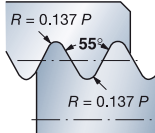

Roscas internas versão esquerda

CZC _{MS}	TPI	DMIN ₁	LU	RE	OHX	Código para pedido	P	M	N	S	Dimensões, mm						
							1025	1025	1025	1025	DCON _{MS}	WB	LPR	LF	WF	HA	HB
							*	*	*	*							
6	19.0	6.2	15.0	0.180	17.0	CXS-06TH19WH-6215L	*	*	*	*	6	4.0	38.3	37.3	3.0	1.1	0.2

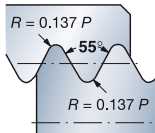

CZC_{MS} para corresponder com CZC_{WS} no adaptador.

R = versão direita, L = versão esquerda



F2



B135



C83



H36



H22



A

Ferramenta inteiraça de metal duro CoroTurn® XS para torneamento de rosca

NPT 60° (NPSC, NPTR, LINE PIPE) Perfil completo

STDNO ANSI B.1.20.1-1983

B

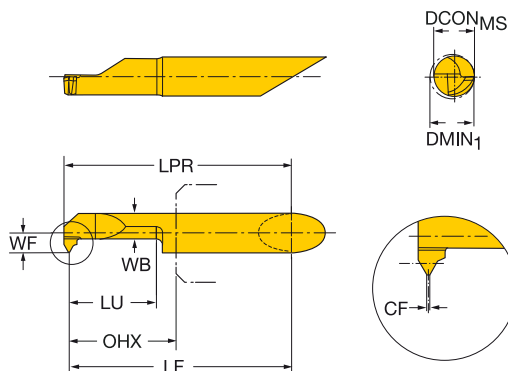
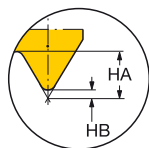

C

Roscas internas versão direita

CZC _{MS}	TPI	DMIN ₁	LU	RE	OHX	Código para pedido	P	M	N	S	Dimensões, mm						
							1025	1025	1025	1025	DCON _{MS}	WB	LPR	LF	WF	HA	HB
6	27.0	6.2	15.0	0.070	17.2	CXS-06TH27NT-6215R	*	*	*	*	6	4.0	38.1	37.3	3.0	1.6	0.0
6	18.0	6.2	15.0	0.100	17.2	CXS-06TH18NT-6215R	*	*	*	*	6	4.0	38.3	37.3	3.0	1.6	0.0

D

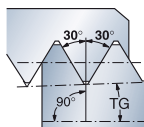

Roscas internas versão esquerda

CZC _{MS}	TPI	DMIN ₁	LU	RE	OHX	Código para pedido	P	M	N	S	Dimensões, mm						
							1025	1025	1025	1025	DCON _{MS}	WB	LPR	LF	WF	HA	HB
6	18.0	6.2	15.0	0.100	17.0	CXS-06TH18NT-6215L	*	*	*	*	6	4.0	38.3	37.3	3.0	1.6	0.0

F

CZC_{MS} para corresponder com CZC_{WS} no adaptador.

R = versão direita, L = versão esquerda

G

H



F2



B135



C83



H36



H22

Ferramenta inteiriça de metal duro CoroTurn® XS para torneamento de roscas

ISO Trapezoidal 30° Perfil da crista chanfrado

TCTR IT 7
 STDNO ISO 2901-2904
 STDNO DIN 103-1977

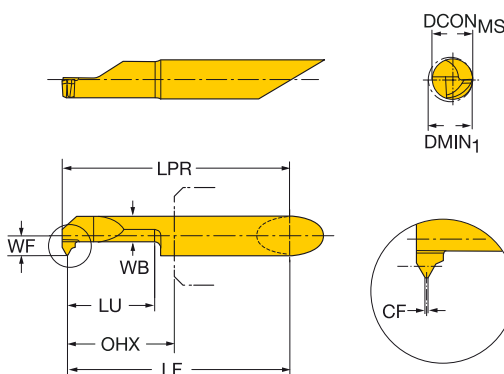
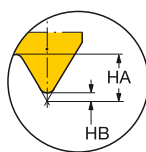

Roscas internas versão direita

CZC _{MS}	TP	DMIN ₁	LU	OHX	Código para pedido	Dimensões, mm			DCON _{MS}	WB	CF	LPR	LF	WF	HA	HB
						P	M	S								
6	1.5	6.2	20.0	17.4	CXS-06TH150TR-6220R	★	★	★	6	4.9	0.5	38.2	37.6	3.0	1.8	0.9
6	2.0	6.2	20.0	17.3	CXS-06TH200TR-6220R	★	★	★	6	4.6	0.6	38.4	37.6	3.0	2.4	1.2
7	3.0	7.2	30.0	16.9	CXS-07TH300TR-7230R	★	★	★	7	4.6	1.0	53.4	52.3	3.5	3.5	1.8

CZC_{MS} para corresponder com CZC_{WS} no adaptador.

R = versão direita



F2



B135



C83



H36



H22



CoroCut® MB

Para usinagem interna com alta precisão

Aplicação

- Para usinagem interna de furos pequenos
- Pré-corte
- Canais
- Canais frontais
- Perfilamento
- Torneamento
- Cópia
- Mandrilamento reverso
- Rosqueamento

Área de aplicação ISO:



Características e benefícios

- Usinagem sem vibrações
- Set-up rápido tanto da ferramenta quanto da pastilha
- Estabilidade e alta precisão entre a interface e o porta-ferramenta
- Ferramenta de corte intercambiável com montagem frontal
- Arestas de corte vivas
- Geometrias e classes para todos os materiais
- Hastes de metal duro para longos balanços
- Refrigeração interna
- Fixação Easy Fix
- Ferramentas para usinagem de canais em uma ampla gama de larguras e raios de canto – também para canais padronizados como O-rings e canais circlip



www.sandvik.coromant.com/corocutmb

EasyFix

Use barras de mandril cilíndricas de aço e de metal duro com buchas EasyFix para obter a altura de centro exata.









Barras de mandril CoroCut® MB

Para estabilidade e acessibilidade, as barras foram desenhadas com cabeça excêntrica e seção cruzada oval.

Adaptadores

- Coromant Capto® para adaptador CoroTurn® XS
Veja página F22.
- Haste retangular para adaptador CoroTurn® XS
Veja página F33.
- Adaptador CoroTurn® XS de haste cilíndrica com planos
Veja página F42.

Pastilhas

	Pré-corte	Canais	Canais frontais	Perfilamento	Torneamento	Cópia	Mandrilamento reverso	Rosqueamento
								
	MB-..GX	MB-..G	MB-F	MB-..R	MB-..T045	MB-..TE93	MB-..B	MB-..TH
Largura da pastilha, mm	1.00	0.73-3.00	1.00-3.00					
Página	B123	B124	B127	Web	Web	Web	Web	C67

Cabeça inteira de metal duro CoroCut® MB para torneamento de roscas

Perfil em V 60° sem formador de crista

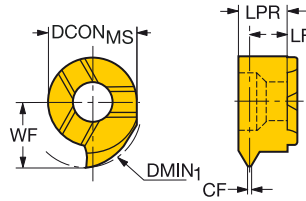
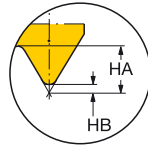

Roscas internas versão direita

CZC _{MS}	TPN	TPX	TPIN	TPIX	DMIN ₁	Código para pedido	P	M	N	S	Dimensões, mm						
							1025	1025	1025	1025	DCON _{MS}	CF	LPR	LF	WF	HA	HB
07	0.50	0.75	34.0	51.0	10.0	MB-07TH050VM-10R	*	*	*	*	7	0.1	3.8	3.4	5.8	0.5	0.1
07	1.00	1.25	20.0	25.0	10.0	MB-07TH100VM-10R	*	*	*	*	7	0.1	3.8	3.2	5.8	0.8	0.1
07	1.50	1.75	15.0	17.0	10.0	MB-07TH150VM-10R	*	*	*	*	7	0.2	3.8	3.0	5.8	1.1	0.2
07	2.00	2.50	10.0	13.0	10.0	MB-07TH200VM-10R	*	*	*	*	7	0.3	3.8	2.8	5.8	1.6	0.2
07	2.50	3.00	8.0	10.0	10.0	MB-07TH250VM-10R	*	*	*	*	7	0.3	3.8	2.6	5.8	2.0	0.3

Roscas internas versão esquerda

CZC _{MS}	TPN	TPX	TPIN	TPIX	DMIN ₁	Código para pedido	P	M	N	S	Dimensões, mm						
							1025	1025	1025	1025	DCON _{MS}	CF	LPR	LF	WF	HA	HB
07	0.50	0.75	34.0	51.0	10.0	MB-07TH050VM-10L	*	*	*	*	7	0.1	3.8	3.4	5.8	0.5	0.1
07	1.00	1.25	20.0	25.0	10.0	MB-07TH100VM-10L	*	*	*	*	7	0.1	3.8	3.2	5.8	0.8	0.1
07	1.50	1.75	15.0	17.0	10.0	MB-07TH150VM-10L	*	*	*	*	7	0.2	3.8	3.0	5.8	1.1	0.2
07	2.00	2.50	10.0	13.0	10.0	MB-07TH200VM-10L	*	*	*	*	7	0.3	3.8	2.8	5.8	1.6	0.2
07	2.50	3.00	8.0	10.0	10.0	MB-07TH250VM-10L	*	*	*	*	7	0.3	3.8	2.6	5.8	2.0	0.3

CZC_{MS} para corresponder com CZC_{WS} no adaptador.

R = versão direita, L = versão esquerda



F2



B134



C83



H36



H25



A

Cabeça inteira de metal duro CoroCut® MB para torneamento de roscas

Métrica 60° Perfil completo

TCTR
STDNOIT 6
ISO 956-1998

B

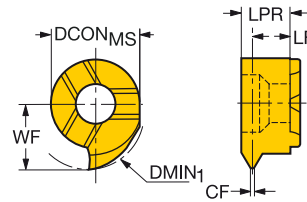
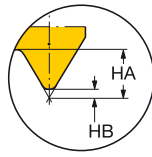

C

Roscas internas versão direita

	CZC _{MS}	TP	DMIN ₁	Código para pedido	P	M	N	S	H	Dimensões, mm						
					1025	1025	1025	1025	7015	DCON _{MS}	CF	LPR	LF	WF	HA	HB
	07	0.5	10.0	MB-07TH050MM-10R	*	*	*	*		7	0.1	3.8	3.4	5.8	0.5	0.1
	07	1.0	10.0	MB-07TH100MM-10R	*	*	*	*	*	7	0.1	3.8	3.2	5.8	0.9	0.1
	07	1.5	10.0	MB-07TH150MM-10R	*	*	*	*	*	7	0.2	3.8	3.0	5.8	1.4	0.2
	07	1.8	10.0	MB-07TH175MM-10R	*	*	*	*	*	7	0.2	3.8	2.9	5.8	1.1	0.2
	07	2.0	10.0	MB-07TH200MM-10R	*	*	*	*	*	7	0.3	3.8	2.8	5.8	1.3	0.2
	07	2.5	10.0	MB-07TH250MM-10R	*	*	*	*	*	7	0.3	3.8	2.6	5.8	1.6	0.3

D

Roscas internas versão esquerda

	CZC _{MS}	TP	DMIN ₁	Código para pedido	P	M	N	S	H	Dimensões, mm						
					1025	1025	1025	1025	7015	DCON _{MS}	CF	LPR	LF	WF	HA	HB
	07	0.5	10.0	MB-07TH050MM-10L	*	*	*	*		7	0.1	3.8	3.4	5.8	0.5	0.1
	07	1.0	10.0	MB-07TH100MM-10L	*	*	*	*	*	7	0.1	3.8	3.2	5.8	0.9	0.1
	07	1.5	10.0	MB-07TH150MM-10L	*	*	*	*	*	7	0.2	3.8	3.0	5.8	1.4	0.2
	07	1.8	10.0	MB-07TH175MM-10L	*	*	*	*	*	7	0.2	3.8	2.9	5.8	1.1	0.2
	07	2.0	10.0	MB-07TH200MM-10L	*	*	*	*	*	7	0.3	3.8	2.8	5.8	1.3	0.2
	07	2.5	10.0	MB-07TH250MM-10L	*	*	*	*	*	7	0.3	3.8	2.6	5.8	1.6	0.3

F

CZC_{MS} para corresponder com CZC_{WS} no adaptador.

R = versão direita, L = versão esquerda

G

H



F2

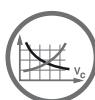

B134



C83



H36



H25

Cabeça inteira de metal duro CoroCut® MB para torneamento de roscas

Whitworth 55° (BSW, BSF, BSP) Perfil completo

TCTR CLASS A
 STDNO ISO 228-1982
 STDNO BS 2779-1973
 STDNO BS 84-1956

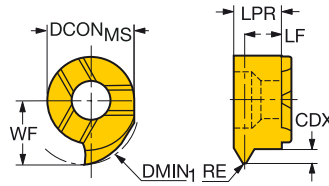
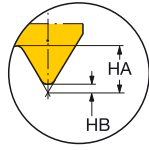

Roscas internas versão direita

CZC _{MS}	TPI	DMIN ₁	RE	Código para pedido	Dimensões, mm									
					P	M	N	S						
07	19.0	10.0	0.180	MB-07TH190WH-10R	1025	1025	1025	1025	DCON _{MS}	LPR	LF	WF	HA	HB
07	14.0	10.0	0.240	MB-07TH140WH-10R	★	★	★	★	7	3.8	2.6	5.8	1.4	0.3
07	11.0	10.0	0.310	MB-07TH110WH-10R	★	★	★	★	7	3.8	2.3	5.8	1.8	0.4

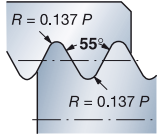

Roscas internas versão esquerda

CZC _{MS}	TPI	DMIN ₁	RE	Código para pedido	Dimensões, mm									
					P	M	N	S						
07	19.0	10.0	0.180	MB-07TH190WH-10L	1025	1025	1025	1025	DCON _{MS}	LPR	LF	WF	HA	HB
07	14.0	10.0	0.240	MB-07TH140WH-10L	★	★	★	★	7	3.8	2.6	5.8	1.4	0.3
07	11.0	10.0	0.310	MB-07TH110WH-10L	★	★	★	★	7	3.8	2.3	5.8	1.8	0.4

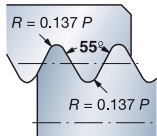

CZC_{MS} para corresponder com CZC_{WS} no adaptador.

R = versão direita, L = versão esquerda



F2

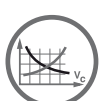

B134



C83



H36

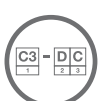

H25

Cabeça inteira de metal duro CoroCut® MB para torneamento de roscas

NPT 60° (NPSC, NPTR, LINE PIPE) Perfil completo

STDNO

ANSI B.1.20.1-1983

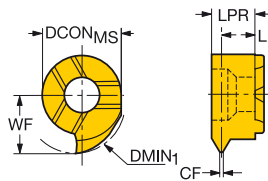
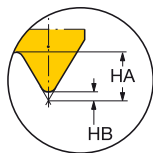
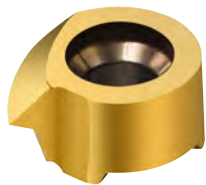

Roscas internas versão direita

CZC _{MS}	TPI	DMIN ₁	RE	Código para pedido	P	M	N	S	Dimensões, mm					
					1025	1025	1025	1025	DCON _{MS}	LPR	LF	WF	HA	HB
07	18.0	10.0	0.050	MB-07TH180NT-10R	*	*	*	*	7	3.8	2.9	5.8	1.4	0.0
07	14.0	10.0	0.070	MB-07TH140NT-10R	*	*	*	*	7	3.8	2.7	5.8	1.5	0.1

Roscas internas versão esquerda

CZC _{MS}	TPI	DMIN ₁	RE	Código para pedido	P	M	N	S	Dimensões, mm					
					1025	1025	1025	1025	DCON _{MS}	LPR	LF	WF	HA	HB
07	18.0	10.0	0.050	MB-07TH180NT-10L	*	*	*	*	7	3.8	2.9	5.8	1.4	0.0
07	14.0	10.0	0.070	MB-07TH140NT-10L	*	*	*	*	7	3.8	2.7	5.8	1.5	0.1

CZC_{MS} para corresponder com CZC_{WS} no adaptador.

R = versão direita, L = versão esquerda



F2

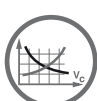

B134



C83



H36



H25



Cabeça inteira de metal duro CoroCut® MB para torneamento de roscas

ACME 29° Perfil parcial

TCTR 2G
STDNO ANSI B1.5-1988

B

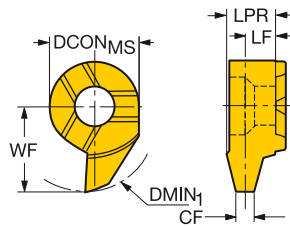
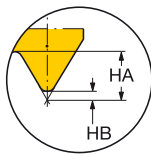

Roscas internas versão direita

C

CZC _{MS}	TPI	DMIN ₁	Código para pedido	P	M	N	S	Dimensões, mm						
				1025	1025	1025	1025	DCON _{MS}	CF	LPR	LF	WF	HA	HB
07	16.0	11.0	MB-07TH160AC-11R	*	*	*	*	7	0.5	3.9	3.3	6.8	2.1	1.0
07	14.0	11.0	MB-07TH140AC-11R	*	*	*	*	7	0.6	3.9	3.2	6.8	2.3	1.2
07	12.0	11.0	MB-07TH120AC-11R	*	*	*	*	7	0.7	3.9	3.1	6.8	2.7	1.4
07	10.0	11.0	MB-07TH100AC-11R	*	*	*	*	7	0.8	3.9	3.0	6.8	3.3	1.6
07	8.0	11.0	MB-07TH080AC-11R	*	*	*	*	7	1.0	3.9	2.8	6.8	4.1	2.0

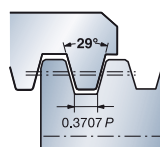

D

STUB-ACME 29° Perfil parcial

TCTR 2G
STDNO ANSI B1.8-1988

E

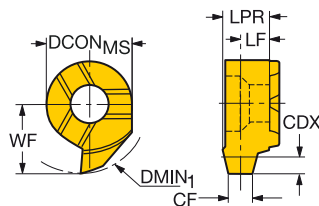
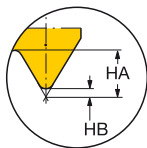

Roscas internas versão direita

F

CZC _{MS}	TPI	DMIN ₁	Código para pedido	P	M	N	S	Dimensões, mm						
				1025	1025	1025	1025	DCON _{MS}	CF	LPR	LF	WF	HA	HB
07	16.0	10.0	MB-07TH160SA-10R	*	*	*	*	7	0.6	4.0	3.4	5.8	1.9	1.1
07	14.0	10.0	MB-07TH140SA-10R	*	*	*	*	7	0.7	4.0	3.3	5.8	2.2	1.3
07	12.0	10.0	MB-07TH120SA-10R	*	*	*	*	7	0.8	4.0	3.2	5.8	2.5	1.6
07	10.0	10.0	MB-07TH100SA-10R	*	*	*	*	7	0.9	3.9	3.1	5.8	3.0	1.8
07	8.0	10.0	MB-07TH080SA-10R	*	*	*	*	7	1.2	3.7	2.5	5.8	3.7	2.3

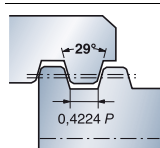

G

CZC_{MS} para corresponder com CZC_{WS} no adaptador.

R = versão direita

H

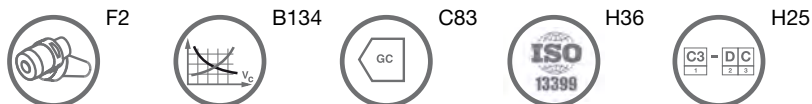

Recomendações de velocidade de corte

ISO P								
N° MC	No. CMC	Material	Força de corte específica k_{ct} N/mm ²	Dureza Brinell HB	Classes			
					GC1125	GC1135	GC1020	H13A
Velocidade de corte (V_c) m/min								
P1.1.Z.AN	01.1	Aços sem liga C = 0.1-0.25%	1500	125	230	205	185	160
P1.2.Z.AN	01.2	C = 0.25-0.55%	1600	150	195	170	155	130
P1.3.Z.AN	01.3	C = 0.55-0.80%	1700	170	180	160	145	125
Aços baixa-liga (elementos de liga ≤5%)								
P2.1.Z.AN	02.1	Não endurecidos	1700	180	155	140	125	115
P2.1.Z.AN	02.12	Aços para rolamento de esferas	1800	210	145	125	115	105
P2.5.Z.HT	02.2	Endurecidos e temperados	1850	275	120	105	95	80
P2.5.Z.HT	02.2	Endurecidos e temperados	2050	350	95	85	75	65
Aços alta-liga (elementos de liga >5%)								
P3.0.Z.AN	03.11	Recozidos	1950	200	140	120	110	105
P3.0.Z.HT	03.21	Aços-ferramenta endurecidos	3000	325	115	100	80	70
Aços fundidos								
P1.5.C.UT	06.1	Sem liga	1550	180	220	200	180	170
P2.6.C.UT	06.2	Baixa-liga (elementos de liga ≤5%)	1600	200	150	130	120	95
P3.0.C.UT	06.3	Alta-liga (elementos de liga >5%)	2050	225	120	105	95	85
P3.2.C.AQ	06.33	Aços-manganês, 12-14% Mn	2900	250	40	38	35	33
ISO M								
Barras/forjados Ferríticos/martensíticos								
P5.0.Z.AN	05.11	Não endurecidos	1800	200	160	145	130	90
P5.0.Z.PH	05.12	Endurecidos PH	2850	330	115	100	90	70
P5.0.Z.HT	05.13	Endurecidos	2350	330	105	95	85	65
Barras/forjados Austeníticos								
M1.0.Z.AQ	05.21	Austeníticos	1800	180	140	130	120	75
M1.0.Z.PH	05.22	Endurecidos PH	2850	330	100	90	80	60
M2.0.Z.AQ	05.23	Super austeníticos	2250	200	80	75	70	50
Aços inoxidáveis - Barras/forjados Austeníticos-ferríticos (Duplex)								
M3.1.Z.AQ	05.51	Não-soldáveis ≥ 0.05%C	2000	230	110	100	90	-
M3.2.Z.AQ	05.52	Soldáveis < 0.05%C	2450	260	90	80	70	-
Aços inoxidáveis - Fundidos Ferríticos/martensíticos								
P5.0.C.UT	15.11	Não endurecidos	1700	200	120	100	90	90
P5.0.C.UT	15.12	Endurecidos PH	2450	330	90	80	70	55
P5.0.C.HT	15.13	Endurecidos	2150	330	70	65	60	50
Aços inoxidáveis - Fundidos Austeníticos								
M1.0.C.UT	15.21	Austeníticos	1700	180	120	110	100	80
M1.0.C.UT	15.22	Endurecidos PH	2450	330	70	65	60	50
M2.0.C.AQ	15.23	Super austeníticos	2150	200	90	80	70	40
Aços inoxidáveis - Fundidos Austeníticos-ferríticos (Duplex)								
M3.1.C.AQ	15.51	Não-soldáveis ≥ 0.05%C	1800	230	100	95	85	-
M3.2.C.AQ	15.52	Soldáveis < 0.05%C	2250	260	75	70	65	-
ISO K								
Ferros fundidos maleáveis								
K1.1.C.NS	07.1	Ferríticos (cavacos curtos)	790	130	170	150	135	95
K1.1.C.NS	07.2	Perlíticos (cavacos longos)	900	230	125	110	100	70
Ferros fundidos cinzentos								
K2.1.C.UT	08.1	Baixa resistência à tensão	890	180	160	140	130	85
K2.2.C.UT	08.2	Alta resistência à tensão	970	220	140	130	120	80
Ferros nodulares SG								
K3.1.C.UT	09.1	Ferríticos	900	160	140	135	125	110
K3.3.C.UT	09.2	Perlíticos	1350	250	110	100	90	80
K3.4.C.UT	09.3	Martensíticos	2100	380	80	75	65	60
ISO N								
Ligas de alumínio Forjadas/forjadas e								
N1.2.Z.UT	30.11	+ trabalhadas a frio, não envelhecidas	400	60	500	500	500	500
N1.2.Z.AG	30.12	Envelhecidas	650	100	500	500	500	450
Ligas de alumínio								
N1.3.C.UT	30.21	Fundidas, não-envelhecidas	600	75	500	500	455	425
N1.3.C.AG	30.22	Fundidas ou fundidas e envelhecidas	700	90	400	325	280	250
N1.4.C.NS	30.41	Fundidas Si 13-15%	700	130	300	270	245	210
N1.4.C.NS	30.42	Fundidas Si 16-22%	700	130	300	270	245	210
Cobre e ligas de cobre								
N3.3.U.UT	33.1	Ligas de corte livre, ≥1% Pb	550	110	500	460	420	370
N3.2.C.UT	33.2	Latão, bronzes com chumbo, ≤1% Pb	550	90	300	270	245	210
N3.1.U.UT	33.3	Bronze e cobre sem chumbo incl. cobre eletrolítico	1350	100	210	190	175	150

Recomendações de velocidade de corte

ISO S									
Nº MC	No. CMC	Material	Força de corte específica k_{c1} N/mm ²	Dureza Brinell HB	Classes				
					GC1125	GC1135	GC1020	H13A	CB7015
Velocidade de corte (V_c) m/min									
Ligas resistentes ao calor									
À base de ferro									
S1.0.U.AN	20.11	Recozidas	2400	200	55	50	45	45	-
S1.0.U.AG	20.12	Envelhecidas	2500	280	35	35	30	30	-
À base de níquel									
S2.0.Z.AN	20.21	Recozidas	2650	250	25	25	20	19	-
S2.0.Z.AG	20.22	Envelhecidas	2900	350	15	15	13	13	-
S2.0.C.NS	20.24	Fundidas	3000	320	13	13	10	11	-
Ligas à base de cobalto									
S3.0.Z.AN	20.31	Recozidas	2700	200	30	30	25	22	-
S3.0.Z.AG	20.32	Envelhecidas	3000	300	20	18	15	14	-
S3.0.C.NS	20.33	Fundidas	3100	320	20	18	15	15	-
Ligas de titânio									
S4.1.Z.UT	23.1	Comercial puro (99.5% Ti)	1300	400 Rm	170	160	140	120	-
S4.2.Z.AN	23.21	α , ligas próximo α e $\alpha + \beta$, recozidas	1400	950 Rm	70	65	60	50	-
S4.3.Z.AG	23.22	ligas $\alpha + \beta$ em condições envelhecidas, ligas β recozidas ou envelhecidas	1400	1050 Rm	60	55	50	40	-
ISO H									
Aços extra-duros									
Endurecidos e temperados									
H1.1.Z.HA	04.1		2750	47 HRC	60	50	50	-	130
H1.3.Z.HA	04.1		4300	60 HRC	39	32	32	-	130
Ferros fundidos coquilhados									
Fundidos ou fundidos e envelhecidos									
H2.0.C.UT	10.1		2250	400	45	40	35	50	-

CoroThread® 266

Rosca (Passo) mm

Fios/polegada

O ângulo de inclinação é calculado usando-se a fórmula:



$$\lambda = \tan^{-1} \left(\frac{P}{d_2 \times \pi} \right)$$

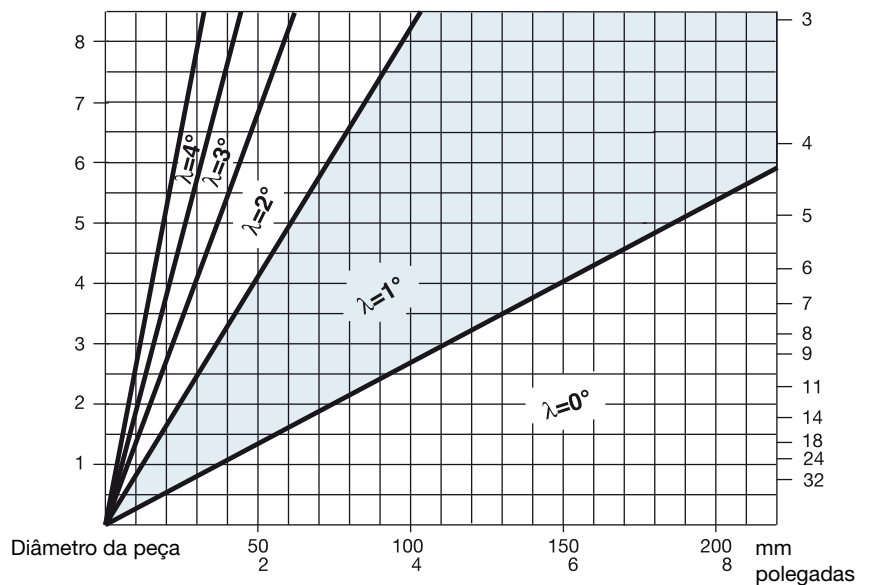

P = Passo

d₂ = Diâmetro efetivo da rosca

λ = Ângulo de inclinação.



Faixa de passos	Tamanho da pastilha	Ângulo de inclinação	Calços	
				
mm			Para ferramenta externa versão direita Para ferramenta interna versão esquerda	Para ferramenta externa versão esquerda Para ferramenta interna versão direita
0.5-3.0	16	-2° -1° 0° 1° 2° 3° 4°	5322 389-22 5322 389-21 5322 389-10 5322 389-11 ¹⁾ 5322 389-12 5322 389-13 5322 389-14	5322 390-22 5322 390-21 5322 390-10 5322 390-11 ¹⁾ 5322 390-12 5322 390-13 5322 390-14
2.5-7.0	22	-2° -1° 0° 1° 2° 3° 4°	5322 379-22 5322 379-21 5322 379-10 5322 379-11 ¹⁾ 5322 379-12 5322 379-13 5322 379-14	5322 380-22 5322 380-21 5322 380-10 5322 380-11 ¹⁾ 5322 380-12 5322 380-13 5322 380-14
8.0	27	0° 1° 2° 3° 4°	5322 387-10 5322 387-11 ¹⁾ 5322 387-12 5322 387-13 5322 387-14	5322 388-10 5322 388-11 ¹⁾ 5322 388-12 5322 388-13 5322 388-14

Faixa de passos	Tamanho da pastilha	Ângulo de inclinação	Calços para suportes 266R/LFA	
				
mm			Para ferramenta externa versão direita Para ferramenta interna versão esquerda	Para ferramenta externa versão esquerda Para ferramenta interna versão direita
0.5-3.0	16	-2° -1° 0° 1° 2° 3° 4°	5322 391-22 5322 391-21 5322 391-10 5322 391-11 ¹⁾ 5322 391-12 5322 391-13 5322 391-14	5322 392-22 5322 392-21 5322 392-10 5322 392-11 ¹⁾ 5322 392-12 5322 392-13 5322 392-14
2.5-7.0	22	0° 1° 2° 3° 4°	5322 393-10 5322 393-11 ¹⁾ 5322 393-12 5322 393-13 5322 393-14	5322 394-10 5322 394-11 ¹⁾ 5322 394-12 5322 394-13 5322 394-14

1) Fornecidos com a ferramenta.

Nota!

Os dois últimos números no código do calço indicam + ou - e o ângulo de inclinação efetivo com o calço montado no suporte, por exemplo 5322 379-11 = ângulo + 1° e 5322 379-21 = ângulo - 1°.

CoroThread® 266

TPI	Ângulo de inclinação				
	4°	3°	2° (-2°)	1° (-1°)	0°
	Diâmetro da rosca, polegadas				
32	<.16	.16-.23	.23-.38	.38-1.14	>1.14
28	<.16	.16-.26	.26-.43	.43-1.30	>1.30
24	<.22	.22-.30	.30-.51	.51-1.52	>1.52
20	<.26	.26-.36	.36-.61	.61-1.82	>1.82
18	<.29	.29-.40	.40-.68	.68-2.03	>2.03
16	<.33	.33-.46	.46-.76	.76-2.28	>2.28
14	<.37	.37-.52	.52-.87	.87-2.61	>2.61
13	<.40	.40-.56	.56-.94	.94-2.81	>2.81
12	<.43	.43-.61	.61-1.01	1.01-3.04	>3.04
11	<.47	.47-.66	.66-1.11	1.11-3.32	>3.32
10	<.52	.52-.73	.73-1.22	1.22-3.65	>3.65
9	<.58	.58-.81	.81-1.35	1.35-4.05	>4.05
8	<.65	.65-.91	.91-1.52	1.52-4.56	>4.56
7	<.74	.74-1.04	1.04-1.74	1.74-5.21	>5.21
6	<.87	.87-1.22	1.22-2.03	2.03-6.08	>6.08
5	<1.04	1.04-1.46	1.46-2.43	2.43-7.30	>7.30
4	<1.30	1.30-1.82	1.82-3.04	3.04-9.12	>9.12
3	<1.74	1.74-2.43	2.43-4.05	4.05-12.15	>12.15

Passo, mm	Ângulo de inclinação				
	4°	3°	2° (-2°)	1° (-1°)	0°
	Diâmetro da rosca, polegadas				
0.50	<.10	.10-.14	.14-.72	.24-.72	>.72
0.75	<.15	.15-.22	.22-.36	.36-1.08	>1.08
1.00	<.20	.20-.29	.29-.48	.48-1.44	>1.44
1.25	<.26	.26-.36	.36-.60	.60-1.80	>1.80
1.50	<.31	.31-.43	.43-.72	.72-2.15	>2.15
1.75	<.36	.36-.50	.50-.84	.84-2.51	>2.51
2.00	<.41	.41-.57	.57-.96	.96-2.87	>2.87
2.50	<.51	.51-.72	.72-1.20	1.20-3.59	>3.59
3.00	<.62	.62-.86	.86-1.44	1.44-4.31	>4.31
3.50	<.72	.72-1.00	1.00-1.68	1.68-5.03	>5.03
4.00	<.82	.82-1.15	1.15-1.92	1.92-5.74	>5.74
4.50	<.92	.92-1.29	1.29-2.15	2.15-6.46	>6.46
5.00	<1.02	1.02-1.44	1.44-2.39	2.39-7.18	>7.18
5.50	<1.13	1.13-1.58	1.58-2.63	2.63-7.90	>7.90
6.00	<1.23	1.23-1.72	1.72-2.87	2.87-8.62	>8.62
7.00	<1.26	1.26-2.00	2.00-3.35	3.35-10.04	>10.04
8.00	<1.64	1.64-2.30	2.30-3.83	3.83-11.84	>11.84

O ângulo de inclinação é calculado usando-se a fórmula:

$$\lambda = \tan^{-1} \left(\frac{P}{d_2 \times \pi} \right)$$

P = Passo

d₂ = Diâmetro efetivo da rosca

λ = Ângulo de inclinação.

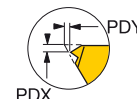

ISO métrica (MM), externa

	Passo, mm														
	0.50	0.75	1.00	1.25	1.50	1.75	2.00	2.50	3.00	3.50	4.00	4.50	5.00	5.50	6.00
PDY	1.32	1.32	1.32	1.32	1.32	1.32	1.32	1.32	1.32	1.67	1.67	1.67	1.38	1.08	0.88
PDX	0.50	0.50	0.80	0.80	1.00	1.20	1.40	1.40	1.80	2.50	2.50	2.50	2.50	2.50	2.80
N° de passadas	Penetração radial por passada														
1	0.10	0.16	0.16	0.17	0.20	0.17	0.20	0.20	0.20	0.24	0.24	0.27	0.29	0.27	0.30
2	0.09	0.15	0.15	0.15	0.19	0.17	0.19	0.19	0.19	0.23	0.22	0.25	0.28	0.26	0.29
3	0.08	0.12	0.14	0.14	0.18	0.16	0.18	0.18	0.19	0.22	0.22	0.24	0.27	0.26	0.29
4	0.07	0.07	0.12	0.13	0.16	0.15	0.17	0.17	0.18	0.21	0.21	0.23	0.26	0.25	0.28
5			0.08	0.12	0.14	0.14	0.16	0.17	0.17	0.21	0.21	0.23	0.25	0.25	0.27
6				0.08	0.08	0.13	0.15	0.16	0.17	0.20	0.20	0.22	0.25	0.24	0.26
7						0.11	0.13	0.15	0.16	0.18	0.19	0.21	0.24	0.23	0.26
8						0.08	0.08	0.14	0.15	0.17	0.18	0.20	0.23	0.23	0.25
9								0.12	0.14	0.16	0.17	0.19	0.22	0.22	0.24
10								0.08	0.13	0.15	0.16	0.18	0.20	0.21	0.23
11									0.12	0.13	0.15	0.17	0.19	0.20	0.22
12									0.08	0.08	0.14	0.16	0.17	0.19	0.20
13											0.12	0.14	0.15	0.18	0.19
14											0.08	0.10	0.10	0.16	0.17
15														0.14	0.15
16														0.10	0.10
Penetração total	0.34	0.50	0.65	0.79	0.95	1.11	1.26	1.56	1.88	2.18	2.49	2.79	3.10	3.39	3.70

ISO métrica (MM), interna

	Passo, mm														
	0.50	0.75	1.00	1.25	1.50	1.75	2.00	2.50	3.00	3.50	4.00	4.50	5.00	5.50	6.00
PDY	1.30	1.30	1.30	1.30	1.30	1.30	1.30	1.30	1.30	1.64	1.64	1.64	1.35	1.06	0.87
PDX	0.50	0.50	0.80	0.80	1.00	1.20	1.40	1.40	1.80	2.50	2.50	2.50	2.50	2.50	2.40
N° de passadas	Penetração radial por passada														
1	0.10	0.15	0.15	0.16	0.20	0.16	0.19	0.19	0.19	0.22	0.24	0.23	0.26	0.25	0.28
2	0.09	0.14	0.14	0.15	0.18	0.15	0.18	0.18	0.18	0.21	0.22	0.23	0.26	0.25	0.27
3	0.08	0.12	0.13	0.14	0.17	0.15	0.17	0.17	0.18	0.20	0.22	0.22	0.25	0.24	0.26
4	0.07	0.07	0.12	0.13	0.15	0.14	0.16	0.17	0.17	0.20	0.21	0.22	0.24	0.24	0.26
5			0.08	0.11	0.13	0.13	0.15	0.16	0.16	0.19	0.21	0.21	0.24	0.23	0.26
6				0.08	0.08	0.12	0.14	0.15	0.16	0.18	0.20	0.20	0.23	0.22	0.24
7						0.11	0.12	0.14	0.15	0.17	0.19	0.20	0.22	0.22	0.24
8						0.08	0.08	0.13	0.14	0.16	0.18	0.19	0.21	0.22	0.23
9								0.12	0.14	0.15	0.17	0.18	0.20	0.20	0.22
10								0.08	0.12	0.14	0.16	0.17	0.19	0.20	0.21
11									0.11	0.12	0.15	0.16	0.18	0.19	0.20
12									0.08	0.08	0.14	0.15	0.16	0.18	0.19
13											0.12	0.14	0.15	0.17	0.18
14											0.08	0.10	0.10	0.16	0.16
15														0.14	0.15
16														0.10	0.10
Penetração total	0.34	0.48	0.63	0.77	0.92	1.05	1.20	1.48	1.78	2.03	2.31	2.61	2.88	3.19	3.44

ISO pol. (UN), externa

	Passo, mm																	
	32	28	24	20	18	16	14	13	12	11	10	9	8	7	6	5	4.5	4
PDY	1.32	1.32	1.32	1.32	1.32	1.32	1.32	1.32	1.32	1.32	1.32	1.32	1.32	1.67	1.67	1.38	1.09	0.79
PDX	0.50	0.80	0.80	0.80	1.00	1.00	1.20	1.40	1.40	1.40	1.40	1.80	1.80	2.50	2.50	2.50	2.65	2.90
N° de passadas	Penetração radial por passada																	
1	0.17	0.15	0.18	0.18	0.20	0.19	0.18	0.20	0.22	0.21	0.21	0.21	0.22	0.25	0.24	0.29	0.28	0.32
2	0.16	0.14	0.16	0.17	0.18	0.18	0.18	0.19	0.21	0.20	0.20	0.20	0.21	0.24	0.23	0.29	0.28	0.32
3	0.13	0.13	0.15	0.15	0.17	0.17	0.17	0.18	0.20	0.19	0.19	0.19	0.20	0.23	0.23	0.28	0.27	0.31
4	0.08	0.11	0.13	0.14	0.15	0.16	0.16	0.17	0.19	0.18	0.18	0.19	0.20	0.22	0.22	0.27	0.26	0.30
5		0.08	0.08	0.12	0.13	0.14	0.15	0.16	0.17	0.17	0.17	0.18	0.19	0.21	0.21	0.26	0.26	0.29
6				0.08	0.08	0.12	0.14	0.14	0.15	0.16	0.16	0.17	0.18	0.20	0.21	0.25	0.25	0.28
7						0.08	0.12	0.13	0.15	0.15	0.15	0.16	0.17	0.19	0.20	0.24	0.24	0.27
8							0.08	0.08	0.08	0.13	0.14	0.15	0.16	0.18	0.19	0.23	0.23	0.26
9										0.08	0.12	0.14	0.15	0.17	0.18	0.22	0.22	0.25
10											0.08	0.12	0.14	0.15	0.17	0.21	0.22	0.24
11												0.08	0.12	0.13	0.16	0.19	0.21	0.23
12													0.08	0.08	0.15	0.18	0.19	0.22
13															0.14	0.15	0.18	0.20
14															0.10	0.10	0.17	0.18
15																	0.15	0.16
16																	0.10	0.10
Penetração total	0.54	0.60	0.70	0.84	0.92	1.04	1.17	1.24	1.35	1.47	1.62	1.79	2.02	2.26	2.64	3.17	3.51	3.94

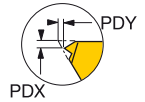

ISO pol. (UN), interna

	Passo, mm																	
	32	28	24	20	18	16	14	13	12	11	10	9	8	7	6	5	4.5	4
PDY	1.30	1.30	1.30	1.30	1.30	1.30	1.30	1.30	1.30	1.30	1.30	1.30	1.30	1.64	1.64	1.35	1.06	0.87
PDX	0.50	0.80	0.80	0.80	1.00	1.00	1.20	1.40	1.40	1.40	1.40	1.80	1.80	2.50	2.50	2.50	2.50	2.60
N° de passadas	Penetração radial por passada																	
1	0.16	0.14	0.16	0.16	0.18	0.17	0.16	0.18	0.20	0.19	0.19	0.19	0.22	0.21	0.23	0.26	0.25	0.28
2	0.14	0.13	0.15	0.16	0.17	0.16	0.16	0.16	0.19	0.18	0.18	0.18	0.21	0.21	0.23	0.26	0.25	0.27
3	0.13	0.12	0.14	0.14	0.16	0.15	0.15	0.15	0.18	0.18	0.17	0.18	0.20	0.20	0.22	0.25	0.24	0.26
4	0.08	0.11	0.12	0.13	0.14	0.14	0.14	0.14	0.17	0.17	0.17	0.17	0.20	0.19	0.22	0.24	0.24	0.26
5		0.08	0.08	0.12	0.13	0.13	0.14	0.14	0.16	0.16	0.16	0.16	0.19	0.19	0.21	0.24	0.23	0.25
6				0.08	0.08	0.12	0.13	0.13	0.14	0.15	0.15	0.16	0.18	0.18	0.20	0.23	0.22	0.24
7						0.08	0.11	0.11	0.13	0.14	0.14	0.15	0.17	0.18	0.20	0.22	0.22	0.24
8						0.08	0.08	0.08	0.12	0.13	0.14	0.16	0.17	0.19	0.21	0.21	0.21	0.23
9									0.08	0.12	0.14	0.15	0.16	0.18	0.20	0.20	0.20	0.22
10										0.08	0.12	0.14	0.15	0.17	0.19	0.20	0.20	0.21
11												0.11	0.12	0.14	0.16	0.18	0.19	0.20
12												0.08	0.08	0.13	0.15	0.16	0.18	0.19
13														0.12	0.14	0.15	0.17	0.18
14														0.08	0.10	0.10	0.16	0.16
15																	0.14	0.15
16																	0.10	0.10
Penetração total	0.51	0.58	0.66	0.78	0.86	0.96	1.07	1.15	1.25	1.36	1.48	1.78	2.03	2.31	2.61	2.88	3.19	3.44

Whitworth (WH), externa e interna

	Passo, mm																	
	28	26	20	19	18	16	14	12	11	10	9	8	7	6	5	4.5	4	
Externa PDY	1.32	1.32	1.32	1.32	1.32	1.32	1.32	1.32	1.32	1.32	1.32	1.32	1.67	1.67	1.38	0.99	0.59	
Externa PDX	0.80	0.80	0.80	0.80	1.00	1.00	1.40	1.40	1.40	1.40	1.80	1.80	2.50	2.50	2.50	2.65	2.75	
Interna PDY				1.30	1.30	1.30	1.30	1.30	1.30	1.30	1.30	1.30	1.64	1.64	1.35	0.96	0.67	
Interna PDX				0.80	0.80	1.00	1.20	1.40	1.40	1.40	1.80	1.80	2.50	2.50	2.50	2.65	2.75	
N° de passadas	Penetração radial por passada																	
1	0.16	0.17	0.19	0.20	0.17	0.17	0.20	0.23	0.22	0.22	0.22	0.23	0.26	0.25	0.31	0.30	0.34	
2	0.15	0.16	0.18	0.18	0.16	0.16	0.19	0.22	0.21	0.21	0.21	0.22	0.26	0.25	0.30	0.29	0.33	
3	0.14	0.14	0.16	0.17	0.16	0.15	0.18	0.21	0.20	0.20	0.20	0.21	0.25	0.24	0.29	0.29	0.32	
4	0.12	0.13	0.15	0.15	0.15	0.15	0.17	0.19	0.19	0.19	0.20	0.21	0.24	0.23	0.28	0.28	0.31	
5	0.08	0.08	0.13	0.13	0.13	0.14	0.16	0.18	0.18	0.18	0.19	0.20	0.23	0.23	0.28	0.27	0.30	
6			0.08	0.08	0.12	0.13	0.14	0.16	0.17	0.17	0.18	0.19	0.22	0.22	0.27	0.26	0.29	
7					0.08	0.11	0.12	0.14	0.15	0.16	0.17	0.18	0.20	0.21	0.25	0.25	0.28	
8						0.08	0.08	0.08	0.13	0.15	0.16	0.17	0.19	0.20	0.24	0.25	0.27	
9									0.08	0.13	0.14	0.16	0.18	0.19	0.23	0.24	0.26	
10										0.08	0.12	0.14	0.16	0.18	0.22	0.23	0.25	
11											0.08	0.12	0.14	0.17	0.20	0.22	0.24	
12												0.08	0.08	0.16	0.18	0.20	0.22	
13														0.14	0.16	0.19	0.21	
14														0.10	0.10	0.17	0.19	
15																0.15	0.16	
16																0.10	0.10	
Penetração total	0.64	0.68	0.88	0.92	0.97	1.08	1.23	1.42	1.54	1.70	1.87	2.10	2.39	2.78	3.32	3.69	4.06	

Round 30° DIN 405 (RN), externa

	Passo, TPI			
	10	8	6	4
PDY	1.33	1.33	1.43	1.38
PDX	0.83	1.05	1.50	2.60
N° de passadas	Penetração radial por passada			
1	0.21	0.21	0.24	0.30
2	0.20	0.20	0.23	0.29
3	0.19	0.19	0.22	0.28
4	0.18	0.19	0.21	0.27
5	0.16	0.18	0.20	0.26
6	0.15	0.17	0.19	0.25
7	0.13	0.15	0.18	0.24
8	0.08	0.14	0.17	0.23
9		0.12	0.16	0.22
10		0.08	0.15	0.21
11			0.13	0.19
12			0.08	0.18
13				0.15
14				0.10
Penetração total	1.30	1.63	2.17	2.95

Round 30° DIN 405 (RN), interna

	Passo, TPI			
	10	8	6	4
PDY	1.30	1.30	1.45	1.35
PDX	1.85	1.05	1.35	2.60
N° de passadas	Penetração radial por passada			
1	0.22	0.21	0.24	0.30
2	0.21	0.20	0.23	0.29
3	0.20	0.20	0.22	0.29
4	0.18	0.19	0.21	0.28
5	0.17	0.18	0.21	0.27
6	0.15	0.17	0.20	0.26
7	0.13	0.16	0.19	0.25
8	0.08	0.14	0.17	0.24
9		0.12	0.16	0.23
10		0.08	0.15	0.21
11			0.13	0.20
12			0.08	0.18
13				0.16
14				0.10
Penetração total	1.34	1.64	2.18	2.98

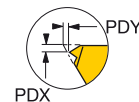

ACME (AC), externa

	Passo, mm								
	16	14	12	10	8	6	5	4	3
PDY	1.33	1.33	1.33	1.33	1.50	1.37	1.37	0.76	0.54
PDX	1.00	1.10	1.20	1.30	1.50	1.90	2.10	2.40	3.30
N° de passadas	Penetração radial por passada								
1	0.22	0.20	0.20	0.20	0.20	0.24	0.26	0.28	0.31
2	0.20	0.19	0.19	0.20	0.20	0.23	0.25	0.28	0.31
3	0.19	0.18	0.18	0.19	0.19	0.23	0.25	0.27	0.30
4	0.17	0.17	0.17	0.18	0.18	0.22	0.24	0.26	0.30
5	0.14	0.15	0.16	0.17	0.18	0.21	0.23	0.26	0.29
6	0.08	0.13	0.15	0.16	0.17	0.20	0.23	0.25	0.28
7		0.08	0.13	0.15	0.16	0.20	0.22	0.24	0.28
8			0.08	0.14	0.15	0.19	0.21	0.23	0.27
9				0.12	0.14	0.18	0.20	0.22	0.26
10				0.08	0.13	0.17	0.19	0.22	0.25
11					0.12	0.16	0.18	0.21	0.24
12					0.08	0.14	0.16	0.19	0.23
13						0.10	0.14	0.18	0.22
14							0.10	0.17	0.21
15								0.15	0.20
16								0.10	0.19
17									0.17
18									0.15
19									0.100
Penetração total	0.99	1.10	1.26	1.60	1.91	2.46	2.87	3.51	4.57

NPT (NT), externa e interna

		Passo, TPI				
		27	18	14	11½	8
Externa	PDY	1.03	1.03	1.03	1.03	1.03
	PDX	0.80	1.00	1.20	1.40	1.60
Interna	PDY	0.72	1.01	1.01	1.01	1.01
	PDX	0.85	1.20	1.20	1.40	1.60
N° de passadas	Penetração radial por passada					
1	0.15	0.17	0.18	0.18	0.21	
2	0.15	0.17	0.17	0.17	0.21	
3	0.14	0.16	0.16	0.17	0.20	
4	0.13	0.15	0.16	0.16	0.20	
5	0.11	0.14	0.15	0.16	0.19	
6	0.08	0.13	0.15	0.15	0.18	
7		0.11	0.14	0.15	0.18	
8		0.08	0.13	0.14	0.17	
9			0.11	0.13	0.17	
10			0.08	0.12	0.16	
11				0.11	0.15	
12				0.08	0.14	
13					0.13	
14					0.11	
15					0.08	
Penetração total	0.62	0.90	1.20	1.51	2.05	

ACME (AC), interna

	Passo, mm								
	16	14	12	10	8	6	5	4	3
PDY	1.30	1.30	1.33	1.33	1.14	1.33	0.92	0.81	0.54
PDX	0.80	1.00	1.10	1.20	1.50	2.00	2.20	2.40	3.30
N° de passadas	Penetração radial por passada								
1	0.22	0.21	0.21	0.21	0.21	0.24	0.26	0.29	0.31
2	0.21	0.20	0.20	0.20	0.20	0.23	0.26	0.28	0.31
3	0.19	0.19	0.19	0.20	0.20	0.23	0.25	0.27	0.30
4	0.17	0.17	0.18	0.19	0.19	0.22	0.24	0.27	0.29
5	0.14	0.16	0.16	0.18	0.18	0.21	0.24	0.26	0.29
6	0.08	0.13	0.15	0.17	0.17	0.21	0.23	0.25	0.28
7		0.08	0.13	0.16	0.17	0.20	0.22	0.24	0.27
8			0.08	0.14	0.16	0.19	0.21	0.23	0.27
9				0.12	0.15	0.18	0.20	0.23	0.26
10				0.08	0.13	0.17	0.19	0.22	0.25
11					0.12	0.16	0.18	0.21	0.24
12					0.08	0.14	0.16	0.20	0.23
13						0.10	0.15	0.18	0.22
14							0.10	0.17	0.21
15								0.15	0.20
16								0.10	0.19
17									0.17
18									0.15
19									0.100
Penetração total	1.02	1.14	1.30	1.64	1.95	2.48	2.90	3.54	4.56

NPTF (NT), externa e interna

		Passo, mm				
		27	18	14	11½	8
Externa	PDY	1.03	1.03	1.03	1.03	1.03
	PDX	0.80	1.00	1.20	1.40	1.60
Interna	PDY			1.01	1.01	1.01
	PDX			1.20	1.40	1.60
N° de passadas	Penetração radial por passada					
1	0.14	0.16	0.17	0.17	0.19	
2	0.13	0.16	0.17	0.17	0.19	
3	0.13	0.15	0.16	0.16	0.18	
4	0.12	0.14	0.16	0.16	0.18	
5	0.11	0.13	0.15	0.15	0.18	
6	0.08	0.12	0.15	0.15	0.17	
7		0.11	0.13	0.14	0.17	
8		0.08	0.12	0.14	0.16	
9			0.11	0.13	0.16	
10			0.08	0.12	0.15	
11				0.11	0.14	
12				0.08	0.14	
13					0.13	
14					0.12	
15					0.11	
16					0.08	
Penetração total	0.70	1.06	1.41	1.69	2.36	

Stub-ACME (SA), externa e interna

	Passo, mm								
	16	14	12	19	8	6	5	4	3
Externa PDY	1.32	1.32	1.32	1.32	1.23	1.67	1.67	1.67	1.76
Externa PDX	0.90	1.00	1.10	1.20	1.50	1.80	2.00	2.40	3.10
Interna PDY		1.64	1.33	1.30	1.20	1.64	1.64	1.64	1.76
Interna PDX		2.40	1.10	1.20	1.50	1.80	2.00	2.40	3.10
N° de passadas	Penetração radial por passada								
1	0.18	0.20	0.18	0.21	0.22	0.24	0.25	0.24	0.25
2	0.16	0.18	0.17	0.20	0.21	0.23	0.24	0.24	0.24
3	0.15	0.17	0.16	0.19	0.19	0.22	0.23	0.23	0.24
4	0.13	0.14	0.15	0.17	0.18	0.21	0.22	0.22	0.23
5	0.08	0.08	0.13	0.15	0.17	0.19	0.21	0.21	0.22
6			0.08	0.13	0.15	0.18	0.19	0.20	0.22
7				0.08	0.13	0.16	0.18	0.19	0.21
8					0.08	0.14	0.16	0.18	0.20
9						0.08	0.14	0.17	0.19
10							0.09	0.16	0.18
11								0.14	0.17
12								0.09	0.16
13									0.15
14									0.13
15									0.09
Penetração total	0.70	0.77	0.87	1.13	1.33	1.64	1.90	2.27	2.90

MJ, externa

	Passo, mm	
	1.5	2
PDY	1.32	1.32
PDX	1.00	1.40
N° de passadas	Penetração radial por passada	
1	0.20	0.19
2	0.18	0.18
3	0.17	0.17
4	0.15	0.16
5	0.13	0.15
6	0.08	0.14
7		0.12
8		0.08
Penetração total	0.92	1.21

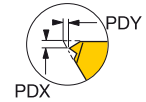

Trapezoidal (TR), externa e interna

BSPT (PT), externa e interna

		Passo, mm							
		1.5	2	3	4	5	6	7	8
Externa	PDY	1.37	1.37	1.27	1.42	1.42	0.81	0.81	0.54
	PDX	1.00	1.10	1.60	1.90	2.10	2.40	2.40	3.30
Interna	PDY		1.40	1.29	1.45	1.45	0.83	1.03	0.54
	PDX		1.00	1.60	1.90	2.10	2.40	2.40	3.30
N° de passadas		Penetração radial por passada							
1		0.22	0.22	0.20	0.24	0.27	0.29	0.34	0.32
2		0.21	0.21	0.19	0.23	0.27	0.29	0.33	0.31
3		0.19	0.20	0.18	0.22	0.26	0.28	0.32	0.31
4		0.17	0.19	0.18	0.22	0.25	0.27	0.32	0.30
5		0.14	0.17	0.17	0.21	0.24	0.27	0.31	0.29
6		0.08	0.16	0.17	0.20	0.23	0.26	0.30	0.29
7			0.13	0.16	0.19	0.22	0.25	0.29	0.28
8			0.08	0.15	0.18	0.21	0.24	0.28	0.27
9				0.14	0.17	0.20	0.23	0.26	0.26
10				0.13	0.16	0.19	0.22	0.25	0.25
11				0.11	0.14	0.17	0.21	0.24	0.25
12				0.08	0.13	0.16	0.20	0.22	0.24
13					0.08	0.13	0.19	0.21	0.23
14						0.08	0.17	0.19	0.22
15							0.15	0.16	0.20
16							0.10	0.10	0.19
17									0.17
18									0.15
19									0.10
Penetração total		1.02	1.36	1.86	2.37	2.88	3.63	4.12	4.62

		Passo, mm				
		28	19	14	11	8
Externa	PDY	1.32	1.32	1.32	1.40	1.32
	PDX	0.80	0.80	1.20	1.40	1.80
Interna	PDY	1.30	1.30	1.30	1.30	1.30
	PDX	0.80	0.80	1.20	1.40	1.80
N° de passadas		Penetração radial por passada				
1		0.15	0.19	0.19	0.22	0.22
2		0.14	0.18	0.18	0.21	0.21
3		0.13	0.17	0.17	0.20	0.21
4		0.12	0.15	0.16	0.19	0.20
5		0.08	0.13	0.15	0.18	0.19
6			0.08	0.14	0.16	0.18
7				0.12	0.15	0.17
8				0.08	0.13	0.16
9					0.08	0.15
10						0.14
11						0.12
12						0.08
Penetração total		0.62	0.90	1.20	1.51	2.05

UNJ, externa

		Passo, mm									
		32	28	24	20	18	16	14	12	10	8
Externa	PDY	1.32	1.32	1.32	1.32	1.32	1.32	1.32	1.32	1.32	1.32
	PDX	0.50	0.80	0.80	0.80	1.00	1.00	1.20	1.40	1.40	1.80
N° de passadas		Penetração radial por passada									
1		0.16	0.14	0.16	0.16	0.18	0.17	0.17	0.20	0.19	0.20
2		0.14	0.13	0.15	0.15	0.17	0.16	0.16	0.19	0.19	0.20
3		0.13	0.12	0.14	0.14	0.16	0.16	0.16	0.18	0.18	0.19
4		0.08	0.11	0.12	0.13	0.15	0.15	0.15	0.17	0.17	0.18
5			0.08	0.08	0.12	0.13	0.13	0.14	0.16	0.16	0.18
6					0.08	0.08	0.12	0.13	0.15	0.15	0.17
7						0.08	0.11	0.13	0.14	0.14	0.16
8							0.08	0.08	0.13	0.13	0.15
9									0.12	0.12	0.14
10									0.08	0.08	0.13
11											0.12
12											0.08
Penetração total		0.51	0.57	0.66	0.78	0.87	0.97	1.10	1.27	1.52	1.90

Multidentes

		ISO métrica					ISO métrica, externa				Whitworth (WH)			NPT
		Passo					Passo				Passo			Passo
		1.00	1.5	2.00	2.50	3.00	18	16	14	12	19	14	11	11½
Externa	PDY	1.62	1.42	1.91	1.98	2.79	2.14	1.52	1.79	1.91	2.04	1.73	1.88	1.67
	PDX	2.02	2.20	2.90	3.75	4.40	3.45	2.40	2.70	3.10	3.30	2.70	3.40	3.40
N° de passadas		Penetração radial por passada												
1		0.34	0.36	0.47	0.46	0.55	0.49	0.39	0.44	0.52	0.49	0.47	0.45	0.50
2		0.31	0.33	0.46	0.43	0.52	0.43	0.36	0.41	0.47	0.43	0.43	0.43	0.48
3			0.26	0.33	0.40	0.48		0.29	0.32	0.36		0.33	0.39	0.44
4					0.27	0.33							0.27	0.31
Penetração total		0.65	0.95	1.26	1.56	1.88	0.92	1.04	1.17	1.35	0.92	1.23	1.54	1.73
		Passo					Passo				Passo			Passo
		1.00	1.50	2.00	2.50	3.00	18	16	14	12	19	14	11	11½
Interna	PDY	1.63	1.41	1.82	1.98	2.79				1.92		1.72	1.85	1.64
	PDX	2.40	2.25	2.85	3.75	4.40				2.95		2.70	3.40	3.40
N° de passadas		Penetração radial por passada												
1		0.33	0.35	0.46	0.45	0.52				0.47		0.45	0.43	0.50
2		0.30	0.32	0.42	0.42	0.49				0.44		0.41	0.41	0.48
3			0.25	0.32	0.36	0.45				0.34		0.32	0.39	0.44
4					0.25	0.32							0.27	0.31
Penetração total		0.63	0.92	1.20	1.48	1.78				1.25		1.18	1.50	1.73

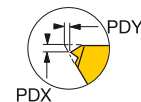

Perfis de rosca API

Pastilha	Passo, TPI	PDY	PDX	N° de passadas															Penetração total			
				1	2	3	4	5	6	7	8	9	10	11	12	13	14	15				
API 60° V-0.038R				Penetração radial por passada																		
266RG-22V381A0402E	4	0.88	2.50	0.36	0.35	0.33	0.32	0.30	0.29	0.27	0.25	0.23	0.20	0.16	0.08						3.08	
266RL-22V381A0402E	4	0.87	2.50	0.36	0.35	0.33	0.32	0.30	0.29	0.27	0.25	0.23	0.20	0.16	0.08						3.08	
266RG-22V381A0403E	4	0.88	2.50	0.36	0.34	0.33	0.32	0.30	0.29	0.27	0.25	0.23	0.20	0.16	0.08						3.07	
266RL-22V381A0403E	4	0.87	2.50	0.36	0.34	0.33	0.32	0.30	0.29	0.27	0.25	0.23	0.20	0.16	0.08						3.07	
API 60° V-0.040																						
226RG-22V401A0503E	5	1.38	2.50	0.35	0.33	0.32	0.31	0.29	0.28	0.26	0.24	0.22	0.19	0.16	0.08						2.98	
226RL-22V401A0503E	5	1.35	2.50	0.35	0.33	0.32	0.31	0.29	0.28	0.26	0.24	0.22	0.19	0.16	0.08						2.98	
API 60° V-0.050																						
266RG-22V501A0402E	4	0.88	2.80	0.34	0.34	0.33	0.31	0.30	0.29	0.28	0.27	0.25	0.24	0.22	0.20	0.18	0.15	0.08				3.74
266RL-22V501A0402E	4	0.87	2.80	0.34	0.34	0.33	0.31	0.30	0.29	0.28	0.27	0.25	0.24	0.22	0.20	0.18	0.15	0.08				3.74
266RG-22V501A0403E	4	0.88	2.80	0.34	0.34	0.32	0.31	0.30	0.29	0.28	0.27	0.25	0.24	0.22	0.20	0.18	0.15	0.08				3.73
266RL-22V501A0403E	4	0.87	2.90	0.34	0.34	0.32	0.31	0.30	0.29	0.28	0.27	0.25	0.24	0.22	0.20	0.18	0.15	0.08				3.73
API Round 60°?																						
266RG-22RD01A100E	10	1.32	1.30	0.18	0.18	0.17	0.16	0.16	0.15	0.14	0.13	0.11	0.08								1.40	
266RL-22RD01A100E	10	1.30	1.30	0.18	0.18	0.17	0.16	0.16	0.15	0.14	0.13	0.11	0.08								1.40	
266RG-22RD01A080E	8	1.32	1.50	0.19	0.19	0.18	0.18	0.17	0.16	0.16	0.15	0.14	0.13	0.11	0.08						1.80	
266RL-22RD01A080E	8	1.30	1.50	0.20	0.19	0.18	0.18	0.17	0.16	0.16	0.15	0.14	0.13	0.11	0.08						1.81	
API Buttress																						
226RG-22BU01A050E	5	1.87	2.00	0.20	0.19	0.18	0.18	0.17	0.16	0.15	0.14	0.13	0.12	0.08							1.65	
226RL-22BU01A050E	5	1.67	2.00	0.20	0.19	0.18	0.18	0.17	0.16	0.15	0.14	0.13	0.12	0.08							1.65	
226RG-22BU01A0501E	5	1.67	2.00	0.20	0.19	0.18	0.18	0.17	0.16	0.15	0.14	0.13	0.12	0.08							1.65	
226RL-22BU01A0501E	5	1.67	2.00	0.20	0.19	0.18	0.18	0.17	0.16	0.15	0.14	0.13	0.12	0.08							1.65	

Recomendações de penetração

O tipo de penetração, número de passadas e o valor da penetração podem ter um impacto decisivo sobre a operação de rosqueamento. As recomendações de penetração são indicadas para valores iniciais. Um número apropriado de passadas deve ser determinado por tentativa e erro. Quanto mais dura for a peça maior o número de passadas.

- O diâmetro da peça não deve ter mais de 0,14 mm (0,006 pol.) que o diâmetro máximo da rosca para otimização da vida útil da ferramenta.
- Deve-se evitar a penetração menor que 0,05 mm (0,002 pol.), e para aços inoxidáveis austenísticos não deve ser menor que 0,08 mm (0,003 pol.).

- Quando usar uma classe de CBN (nitreto cúbico de boro), o valor máx. de penetração deve ser 0,07 mm (0,003 pol.).
- Para pastilhas com geometria C, não deve ser usado uma passada em vazio (um passe sem penetração).
- Para pastilhas multidentes, é essencial que as recomendações na página C80 sejam usadas.
- Para pastilhas com perfil em V, o número de passadas recomendado que é usado para pastilhas de perfil completo pode ser usado.

C

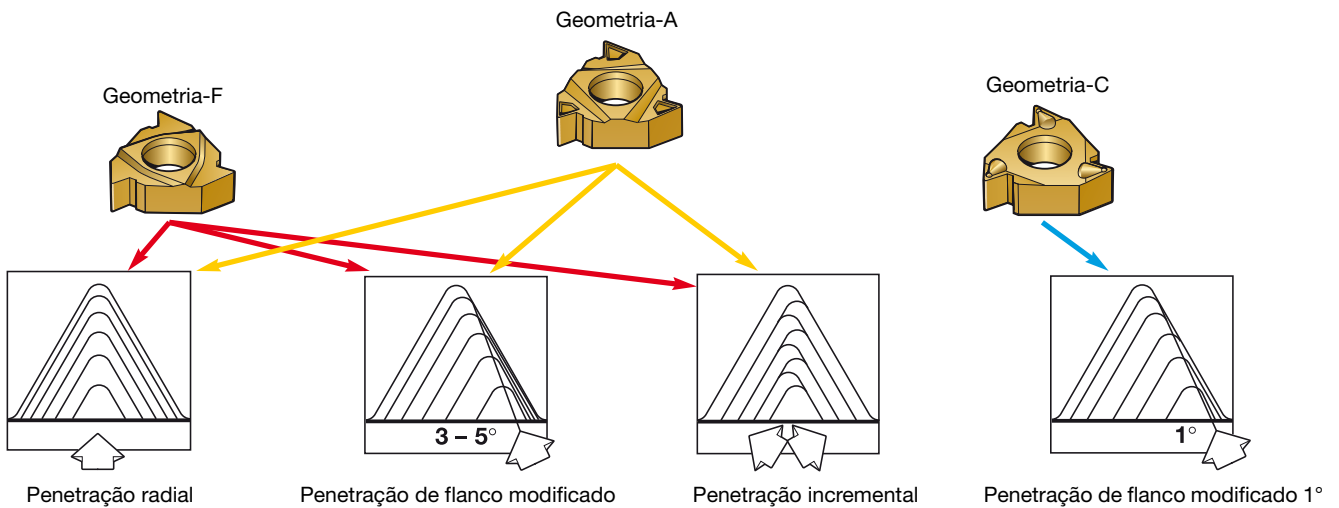

D

E

Velocidade de corte

As recomendações de velocidade de corte inicial são fornecidas à página C73. Uma observação cuidadosa da aresta de corte pode auxiliar na obtenção dos melhores resultados possíveis na área de rosqueamento.

- Velocidade de corte muito baixa pode resultar em aresta postiça
- Velocidade de corte muito alta pode resultar em deformação plástica da aresta

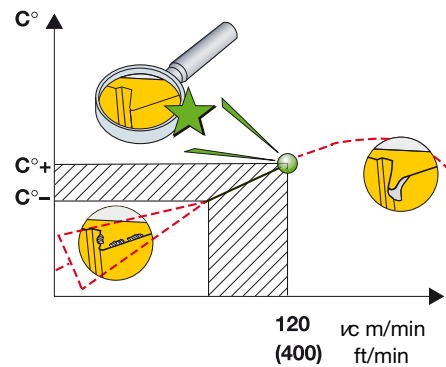

F

Fórmula

Fórmula para calcular a penetração para cada passada em uma série reduzida.

$$\Delta_{apx} = \frac{a_p}{\sqrt{nap-1}} \times \sqrt{\phi}$$

- Δ_{ap} Penetração radial
- x Passada real (em uma série de 1 a nap)
- a_p Profundidade total da rosca
- nap Número de penetrações. Veja página C77
- ϕ 1ª passada = 0,3
- 2ª passada = 1
- 3ª e demais passadas = x-1

G

H

Classes para rosqueamento

P Aços, ferros fundidos, aços inoxidáveis martensíticos, ferros maleáveis com cavacos longos



GC1125 (HC) - P20 (P05-P35)

Classe com cobertura PVD e resistência muito boa ao desgaste para várias aplicações de rosqueamento em aços. Deve ser usada com velocidades de corte elevadas e tempos de corte longos.



GC1020 (HC) - P20 (P10-P40)

Boa classe com cobertura PVD para uso geral em operações de torneamento de aços. Combina boa resistência ao desgaste e agudeza da aresta em aços baixo teor de carbono.



GC1135 (HC) - P25 (P10-P45)

Classe de uso geral com cobertura PVD com boa resistência ao desgaste e tenacidade da aresta de corte para rosqueamento de diversos tipos de aço. Deve ser usada com velocidades de corte médias.

M Aços inoxidáveis austeníticos/ferríticos/martensíticos, aços fundidos, aços-manganês, ligas de ferros fundidos, ferros maleáveis, aços de corte livre.



GC1125 (HC) - M20 (M10-M30)

Classe com cobertura PVD para aços inoxidáveis e outros materiais pastosos com velocidade de corte mais alta.



GC1020 (HC) - M20 (M10-M30)

Boa classe com cobertura PVD de uso geral com boa resistência ao desgaste e agudeza da aresta em materiais não ferrosos.



GC1135 (HC) - M25 (M10-M35)

Classe de uso geral com cobertura PVD com boa resistência ao desgaste e tenacidade da aresta de corte muito boa para aços inoxidáveis e outros materiais pastosos. Deve ser usada com velocidades de corte médias. Primeira escolha na área M para operações de rosqueamento com exigência de tenacidade.

K Ferros fundidos, ferros fundidos coquilhados, ferros maleáveis de cavacos curtos.



GC1125 (HC) - K15 (K05-K20)

Classe com cobertura PVD. Combina a resistência superior ao desgaste de uma classe com cobertura com aresta viva e tenacidade de uma classe sem cobertura. Otimizada para rosqueamento de aços e para velocidades médias a altas.



GC1020 (HC) - K10 (K01-K20)

Classe de uso geral, competitiva para rosqueamento. Trabalha melhor com velocidades de corte média ou baixa, com uma cobertura fina ideal para arestas de corte vivas.



GC1135 (HC) - K20 (K10-K30)

Boa classe de uso geral, com cobertura, e boa resistência ao desgaste e tenacidade da aresta de corte para rosqueamento em aços. Deve ser usada com velocidades de corte médias.

N Metais não-ferrosos



GC1125 (HC) - N25 (N15-N35)

Classe com cobertura PVD. Combina a resistência superior ao desgaste de uma classe com cobertura com aresta viva e tenacidade de uma classe sem cobertura. Otimizada para rosqueamento de aços e para velocidades médias a altas.



GC1020 (HC) - N25 (N10-N30)

Classe de uso geral, competitiva para rosqueamento. Trabalha melhor em velocidades de corte média ou baixa, com uma cobertura fina ideal para arestas de corte vivas.



GC1135 (HC) - N25 (N10-N30)

Classe PVD otimizada para aços inoxidáveis e superligas resistentes ao calor. A melhor escolha para perfis vivos em todos os materiais e para velocidade baixa a média.

Letras-símbolo especificando a designação de materiais de corte duros:

Metais duros:

HW	Metal duro sem cobertura contendo principalmente carboneto de tungstênio (WC)
HT	Metal duro sem cobertura, também chamado cermet, contendo principalmente carbonetos de titânio (TiC) ou nitretos de titânio (TiN) ou ambos
HC	Metais duros como acima, porém com cobertura

Cerâmicas:

CA	Cerâmicas à base de óxido contendo principalmente óxido de alumínio (Al ₂ O ₃)
CM	Cerâmicas mistas contendo principalmente óxido de alumínio (Al ₂ O ₃) e outros elementos além de óxidos
CN	Cerâmicas à base de nitreto, principalmente nitreto de silício (Si ₃ N ₄)
CC	Cerâmicas como acima, porém com cobertura

Diamante:

DP Diamante policristalino¹⁾

Nitreto de boro:

BN Nitreto de boro policristalino¹⁾

¹⁾ Diamante policristalino e nitreto de boro policristalino são também denominados materiais de corte superduros.

Classes para rosqueamento

S

Super ligas e ligas resistentes ao calor

**GC1020 (HC)** – S20 (S05-S30)

Uma classe de metal duro com cobertura PVD para operações exigindo tenacidade como a usinagem de super ligas. Deve ser usada com velocidades de corte baixas.

H

Materiais endurecidos

**CB7015 (BN)** – H15 (H01-H25)

Essa classe tem um baixo teor de Nitreto Cúbico de Boro o que a torna adequada para aplicações de rosqueamento em aços endurecidos.

C**GC1125 (HC)** – S20 (S10-S25)

Classe de metal duro com cobertura PVD para operações de usinagem de super ligas com exigência de tenacidade. Deve ser usada para velocidades de corte mais baixas.

D**GC1135 (HC)** - S25 (S10-S35)

Boa classe de metal duro de uso geral com cobertura PVD para rosqueamento difícil de super ligas. Deve ser usada com baixas velocidades de corte. Primeira escolha na área S.

P M K N S O**E****GC1105 (HC)** - S15 (S10-S20)

Classe de metal duro com cobertura PVD de alta dureza e boa resistência contra deformação plástica propiciando excelente desempenho e desgaste de flanco uniforme.

F**GC1025 (HC)** - S25 (S15-S35)

Uma classe com cobertura PVD para operações que exijam tenacidade, recomendada para cortes interrompidos. Para uso com baixas velocidades de corte.

G

Letras-símbolo especificando a designação de materiais de corte duros:

Metais duros:

HW	Metal duro sem cobertura contendo principalmente carboneto de tungstênio (WC)
HT	Metal duro sem cobertura, também chamado cermet, contendo principalmente carbonetos de titânio (TiC) ou nitretos de titânio (TiN) ou ambos
HC	Metais duros como acima, porém com cobertura

Cerâmicas:

CA	Cerâmicas à base de óxido contendo principalmente óxido de alumínio (Al ₂ O ₃)
CM	Cerâmicas mistas contendo principalmente óxido de alumínio (Al ₂ O ₃) e outros elementos além de óxidos
CN	Cerâmicas à base de nitreto, principalmente nitreto de silício (Si ₃ N ₄)
CC	Cerâmicas como acima, porém com cobertura

Diamante:

DP Diamante policristalino¹⁾

Nitreto de boro:

BN Nitreto de boro policristalino¹⁾

¹⁾ Diamante policristalino e nitreto de boro policristalino são também denominados materiais de corte superduros.

Ferramentas multifunção

CoroPlex™ TT	D2
Pastilhas	A152
Ferramentas	D3-D4
CoroPlex™ TB	D5
Pastilhas	A152
Ferramentas	D6
CoroPlex™ MT	D7
Pastilhas	A40
Ferramentas	D8

CoroPlex™ TT

Duas ferramentas de torneamento em uma

Aplicação

- Torneamento externo
- Torneamento interno
- Perfilamento

Área de aplicação ISO:



Características e benefícios

- Tempo de troca de ferramenta reduzido
- Troca Rápida com Coromant Capto®
- Solução com refrigeração para máquinas multitarefas
- Porta-ferramentas flexíveis otimizadas no comprimento e na estabilidade



CoroPlex TT é uma ferramenta conjugada com excelente flexibilidade. Com duas pastilhas para torneamento na mesma ferramenta, há uma economia de tempo significativa na troca da ferramenta. CoroPlex TT oferece uma variedade de soluções para a maioria das operações de torneamento. www.sandvik.coromant.com/coroplextt

Pastilhas

- Pastilhas tipo T-Max P - C, D
- Geometrias e classes de pastilha para todos os materiais

Ferramentas

- Unidades de corte Coromant Capto®

Com fuso da ferramenta inclinado a 45°

- Faceamento e torneamento longitudinal
- Perfilamento

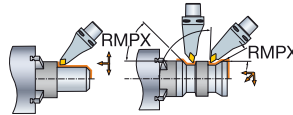

Com fuso da ferramenta inclinado a 90°

- Torneamento longitudinal externo
- Faceamento externo
- Torneamento interno

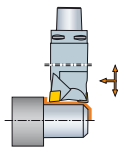

A152



F2

Ferramenta multifunção CoroPlex™ TT para torneamento

Fixação rígida

Coromant Capto® - Refrigeração interna



- CNMM
- CNMG
- CNMA, CNGA

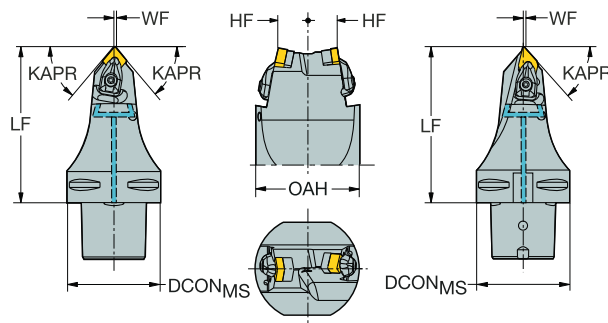

- DNMM, DNMX
- DNMG
- DNMA, DNGA

		CZC _{MS}	KAPR	CNSC	Código para pedido	Dimensões, mm						MIID			
						DCON _{MS}	LF	WF	HF	OAH	BAR		KG	NM	
		C5		1	C5-T-DCM12DDM15L115	50				70	80	1.8			
		12	50				115	0.5	20				3.9	CNMG 12 04 08	
		15	48					115	0.5	20			3.9	DNMG 15 06 08	
			C6		1	C6-T-DCM12DDM15L105	63				70	80	1.8		
		12	50					105	0.5	20			3.9	CNMG 12 04 08	
		15	48					105	0.5	20			3.9	DNMG 15 06 08	
			C6		1	C6-T-DCM12DDM15L130	63					80	2.5		
		12	50					130	0.5	20	70			3.9	CNMG 12 04 08
		15	48					130	0.5	20	70			3.9	DNMG 15 06 08
			C8		1	C8-T-DCM16DDM15L160	80					80	4.7		
	16	50					160	0.5	24				3.9	CNMG 12 04 08	
	15	48					160	0.5	24				3.9	DNMG 15 06 08	
		C10		1	C10-T-DCM19DDM15L180	100					80	6.2			
	19	50					180	0.5	24				6.4	CNMG 19 06 12	
	15	48					180	0.5	24				3.9	DNMG 15 06 08	



A152



F2



H36



H5



A

FERRAMENTAS MULTIFUNÇÃO

Ferramenta multifunção

Ferramenta multifunção CoroPlex™ TT para torneamento

Fixação rígida

Coromant Capto® - Refrigeração interna

KAPR

95°

B



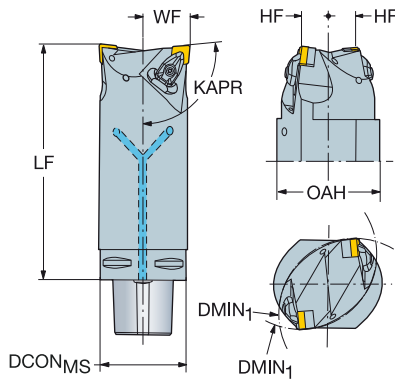

C

-  CNMM
-  CNMG
-  CNMA, CNGA

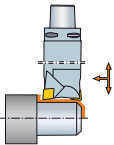

D



				Dimensões, mm											
		CZC _{MS}	DMIN ₁	CNSC	Código para pedido	DCON _{MS}	LF	WF	HF	OAH	BAR	KG	NM	CICT	MIID
	12	C5	110	1	C5-T-DCL12DCL12L130	50	130	26	20	69	80	2.7	3.9	2	CNMG 12 04 08
	12	C6	110	1	C6-T-DCL12DCL12L165	63	165	33	20	75	80	4.7	3.9	2	CNMG 12 04 08
	16	C8	115	1	C8-T-DCL16DCL16L200	80	200	33	20	80	80	7.0	6.4	2	CNMG 16 06 12

E

F

G

H



A152



F2



H36



H5

D 4

CoroPlex™ TB

Barra de mandrilar multifuncional para torneamento dedicada para máquinas multitarefas e centros de torneamento.

Aplicação

- Soluções integradas para centros de torneamento: Alto volume, como transmissão automotiva, rolamentos etc.
- Soluções modulares para máquinas multitarefas e centros de torneamento grandes, como no setor de petróleo e gás

Área de aplicação ISO:



Características e benefícios

- Controle de cavacos e vida útil da ferramenta mais longa
- Tempos de set-up reduzidos com Coromant Capto®
- Troca rápida de ferramentas para redução do tempo de máquinas paradas
- Redução dos custos com manutenção e com tempo de máquinas paradas
- Troca rápida e modularidade com Coromant Capto®
- Duas pastilhas na mesma ferramenta
- Maior número de posições da ferramenta

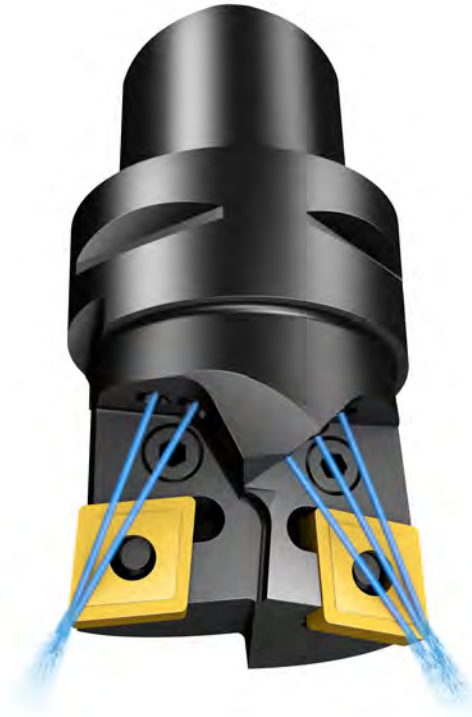

www.sandvik.coromant.com/coroplextb

Pastilhas

- T-Max P - Pastilhas tipo C
- Geometrias e classes de pastilha para todos os materiais

Ferramentas

- Unidades de corte Coromant Capto®

Exemplo de aplicação – engrenagem com CoroPlex TB

O exemplo mostra como é possível usar a mesma ferramenta para torneamento de diâmetro interno e externo sem tempo de indexação entre as operações.

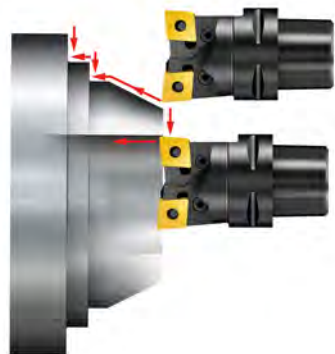

A152



F2

A

Ferramenta multifunção CoroPlex™ TB para torneamento

Fixação por alavanca

Coromant Capto® - Refrigeração interna

B



KAPR

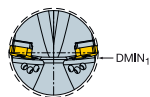

95°

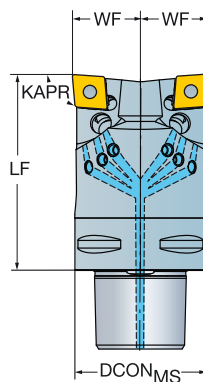

C



- CNMM
- CNMG
- CNMA, CNGA

D

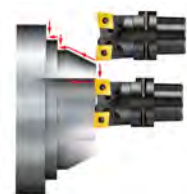

				Código para pedido	Dimensões, mm									
	CZC _{MS}	DMIN ₁	CNSC		DCON _{MS}	LF	WF	HF	BAR	KG	NM	CICT	MIID	
	12	C4	43	3	C4-TB-CN12CN12-060	40	60	21.0	0.0	80	0.5	5.0	2	CNMG 12 04 08
	12	C5	53	3	C5-TB-CN12CN12-075	50	75	26.0	0.0	80	1.0	5.0	2	CNMG 12 04 08
	12	C6	66	3	C6-TB-CN12CN12-090	63	90	32.0	0.0	80	2.0	5.0	2	CNMG 12 04 08

E

F

G

H



D 6



CoroPlex™ MT

Ferramenta multifuncional para fresamento e torneamento, especiais para máquinas multitarefas.

Aplicação

- Soluções integradas para centros de torneamento: Alto volume, como transmissão automotiva, rolamentos etc.
- Soluções modulares para máquinas multitarefas e centros de torneamento grandes, como no setor de petróleo e gás

Área de aplicação ISO:



Características e benefícios

- Troca rápida e modularidade com Coromant Capto®
- Maior número de posições da ferramenta
- Uma ferramenta para fresamento e duas para torneamento em uma
- Tempo de troca de ferramenta reduzido
- Economia de alojamento de ferramentas no magazine
- Aplicação estacionária como uma ferramenta para torneamento, externo ou interno



www.sandvik.coromant.com/coroplexmt

Pastilhas

- Pastilhas CoroTurn 107 tipo C e D
- Pastilhas CoroMill 390, consulte o catálogo Ferramentas rotativas

Ferramentas

- Unidades de corte Coromant Capto®

Uma ferramenta para uso rotativo e estacionário

As pastilhas CoroMill 390 estão posicionadas um pouco à frente das pastilhas CoroTurn – de modo axial e radial – para garantir que as pastilhas de torneamento não estejam em corte quando a ferramenta for aplicada como rotativa. Por isso é necessário parar o avanço e a rotação durante o torneamento interno de um furo cego, antes que as pastilhas CoroMill 390 entrem em contato com a face do fundo.

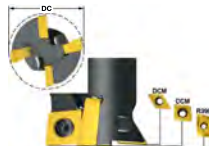

Comprimentos otimizados da ferramenta para acessibilidade em operações de usinagem multitarefas

Os corpos da ferramenta foram ampliados em 65 mm comparado com as ferramentas convencionais correspondentes, para permitir uso livre de posições de trabalho possíveis na usinagem multitarefas, sem qualquer necessidade de extensões. O comprimento e o desenho do corpo da ferramenta foram otimizados para cada tamanho Coromant Capto®, a fim de proporcionar a melhor acessibilidade relativa aos tamanhos de placas mais comuns.



A40



F2

A

FERRAMENTAS MULTIFUNÇÃO

Ferramenta multifunção

Ferramenta multifunção CoroPlex™ MT para torneamento e fresamento

Fixação por parafuso

Coromant Capto® - Refrigeração interna

B



C

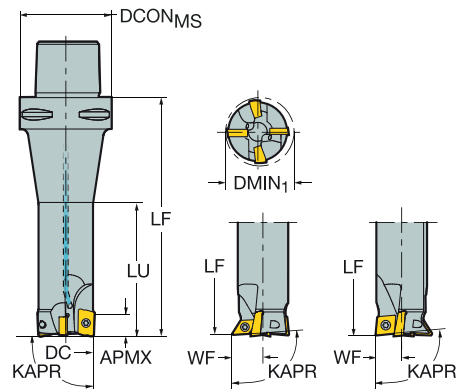
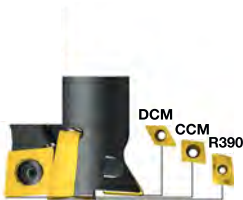

D



CZC _{MS}	DMIN ₁	CNSC	Código para pedido	Dimensões, mm								MIID
				DCON _{MS}	DC	LF	LU	APMX	KG	NM		
07	C5	35	3	M-32C5-39011C09D07	50	32.0	130	81	10.0	1.1	3.0	R390-11..
07	C6	35	3	M-32C6-39011C09D07	63	32.0	165	81	10.0	1.9	3.0	DCMT 07 02 04
18	C6	43	3	M-40C6-39018C12D11	63	40.0	165	92	10.0	2.0	3.0	R390-18..
18	C8	43	3	M-40C8-39018C12D11	80	40.0	200	92	10.0	3.6	3.0	DCMT 11 T3 08

E

F

G

H



A40



F2



H36



H5

D 8

SANDVIK
Coromant

Sistemas de fixação

Unidades de fixação adaptadas à máquina

E2-E3

Unidades de fixação não específicas para máquina

VDI para unidade de fixação Coromant Capto®	E4-E5
VDI para adaptador CoroTurn® SL	E6
VDI para CoroChuck™ 935	E7
VDI para adaptador de haste retangular	E8
VDI para adaptador de lâminas	E9
VDI para adaptador VL	E10
Bloco de ferramenta para lâminas	E11
Unidade de fixação Coromant Capto® para haste retangular	E12
Unidade de fixação Coromant Capto® para haste cilíndrica com planos	E13
Haste cilíndrica com planos para adaptador VL	E14
Unidade de fixação Coromant Capto®	E15

Unidades de fixação adaptadas à máquina

Aplicação

- Torneamento — dois e quatro eixos
- Máquinas multitarefas

Características técnicas

- Troca rápida com sistema de ferramentas Coromant Capto®
- Refrigeração interna em todas as unidades de fixação
- Alta rigidez e precisão para posicionamento e estabilidade precisos da ferramenta



O programa de unidades de fixação mostrado nesse catálogo é apenas uma parte da oferta total. Nossas unidades de fixação de uso geral podem ser encontradas nas páginas a seguir. Para unidades de fixação específicas para a máquina, veja o link abaixo.

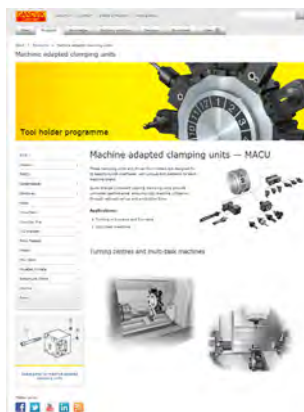

<http://www.sandvik.coromant.com/macu>

As unidades de fixação Coromant Capto® Troca Rápida proporcionam desempenho inigualável, assegurando que a utilização da máquina seja otimizada por meio do tempo reduzido de produção e set-up.



Programa

Encontre abaixo a interface mais adequada para sua máquina. Acesse www.sandvik.coromant.com/mac para obter mais informações e pedir as unidades de fixação específicas para a máquina, bem como os porta-ferramentas acionados de sua escolha.

Centros de torneamento com opção para fresamento

Máquina	Interface	Modelo
Biglia	BI55A	B301, B501, B650, B658, B1200, BV210, BV315, B446, B465, B545, B565, B745, B765, B750, B1250 (torre com 16 estações), Quattro B445, B470
Biglia	BI55B	B446, B465, B545, B565, B745, B765, B750, B1250 (torre com 16 estações), Quattro B445, B470
DMG MORI	MS40A	DuraTurn 2050, 2550 MC, NL 1500, 2000 (20stn), NT 1000, 3100, 3150, 3200, NTX 1000, 2000, NZ/NZX 1500, 2000
DMG MORI	MS60A	NL, NLX 1500-4000 MC/ Y/ SMC/ CY , NT4200, 4250, NT4300, 5400, (NZL 2500), NZX 2500
DMG MORI	MS75A	NZX 4000, NLX6000
DMG MORI	MS110A	NZX 6000
DMG MORI	GM40V	CTX beta 4A, CTX beta
Doosan	BT45A	Lynx 220 M/LM, 220 LMS/LY/LSY, Puma MX1600 ST , Lynx 2100 M/MS
Doosan	BT55A	Puma TT1500, 1800 MS/SY Puma 230-280 M/MS, Puma 1500-2500 M/MS, Puma TL2000, 2500M, Lynx 300 M
Doosan	BT65A	Puma 2100, 2600, 3100 M/MS/Y/SY, TT2000, 2500 MS/SY, MX2000, 2500, 2600 T/ST/SY, 300 M/MS
Doosan	BT65A/B	Puma GT3100 M/LM
Doosan	BT75A	Puma 400, 480M/LM, V550 M, VT750 M, M-2SP
Doosan	BT85A	Puma 600/700/800 LM, VT900 M
Emag	EM55A	Torre VL2, VLC100, VL4 tamanho 330 & 360
Emag	EM65A	VL6
Emag	EM65B	VT4
Emag	EM75A	VL8
Emag	EM68A	VLC 250 , VL 3, 5, VSC 200, 250 , VTC 250
Hwacheon	BT55A	Cutex 160 MC
Hwacheon	BT65A/B/C	Cutex 240 MC/SMC, Hi-Tech 200 MC, Hi-Tech 450 MC/SMC/YMC/YSMC, T2 MC/SMC/YMC/YSMC
Hwacheon	BT75A/B	Hi-Tech 550 MC, VT 550 MC
Hwacheon	BT85A/B/C	Hi-Tech 850 MC/YMC, VT 950, 1150 MC
Hyundai Wia	BT55A	L160, 230MA/LMA/LMSA, LM1600, 1800 TTSY, SKT160, 180 TTMS/TTSY (BMT55)
Hyundai Wia	BT65A/B	L300 M/MS, L2100 Y/SY, L2600 Y/SY, LM2000, 2500 TTM/TTMS/TTSY, SKT250, 300 M/MS, SKT200, 250 TT M/MS/SY
Hyundai Wia	BT75A/B	L400, 500 MA/MC/LMC, LV800RM / SKT-V80RM, SKT400M
Hyundai Wia	BT85A/B	L600, 700, 800 M/LM, SKT600, 700 LM
Mazak	MZ40V	QTN200, 250M, MS, MSY
Mazak	MZ40X	Hyper Quadrex 200MSY, MultiPlex 6200, 6250Y
Mazak	MZ50V	QTN 300, 350, 400, 450M, MY, Hyper Quadrex 450M, STN 500, 550M, MTN 900M
Mazak	MZ68A	QTN 200M, 250M
Mazak	MZ68B	QTS 200M, 250M
Mazak	MZ68C	QTS 100M, 150M
Mazak	MZ80A	QTS 300M, 350M
Mazak	MZ-F	Cybertech Turn 4500/5500M, MT, MTN1600
Muratec Murata	MA-C	MT100
Muratec Murata	MA-E	MT200
Nakamura	NA44A	WT-100, WY-100, Super NTY3, NTJ-100
Nakamura	NA55A	WT-150, 250 II, Super NTJ, NTM3, NTJX, SC-200, 250, TW-10, 20 (16stn)
Nakamura	NA65A	WT-300, Super NTX, TW-20 (12stn), SC-300
Nakamura	NA75A	TW-30, SC-450, STW-40
Okuma	OK55A	LT 2000 EX, M, MY (16 stn.)
Okuma	OK60A	LB2000, 2500, 3000 EX
Okuma	OK60B	LB4000 EX
Okuma	OK60C	LT3000 EX, M, MY
Okuma	OK80A	LB45 III MY

Centros de torneamento sem opção para fresamento

Máquina	Interface	Modelo
DMG MORI	MS-A	DuraTurn 2030, 2050, 2550, NLX 2500, (CMZ TC 15 - 35, TL 20, 25)
DMG MORI	MS-B	SL400, 404
DMG MORI	MS-C	SL65, 600, 603, 75
DMG MORI	MS-D	CL2000
DMG MORI	GM40V (Trifix)	CTX beta 4A, CTX beta
Doosan	DO-A	Puma 2100, 2600, 3100
Doosan	DO-B	Puma 400
Doosan	DO-C	Puma 480, 600, 700, 800, 5100LB
Doosan	DO-D	Puma V550
Doosan	DO-E	Puma VT750
Doosan	DO-F	Puma VT900
Doosan	DO-G	Lynx 220, 2100A / LA/ B/ LB, 220 A/B, LSA/LSC
Fuji	FJ-A	DLFn
Mazak	MZ-A	QTS 200
Mazak	MZ-B	QTN 150, 200, 250, 300, 350, Quick Turn 18 (8 STN), QTS 300, 350
Mazak	MZ-C	QTN 400, 450, MTN 900
Mazak	MZ-D	ST50, STN 500, 550 métrico
Mazak	MZ-E	ST60, 80, STN600, 800 métrico
Mazak	MZ-G	ST50, STN 500, 550 pol.
Mazak	MZ-H	ST60, 80, STN600, 800 pol.
Muratec Murata	MA-A	MW120
Muratec Murata	MA-B	MW200
Muratec Murata	MA-D	MW40
Okuma	OK-A	SpaceTurn LB2000
Okuma	OK-B	LB/LU2500, 3000, 4000 EX, LU25, Captain L470, LB15, LB400, Genos L400
Okuma	OK-E	LU35, LB35
Okuma	OK-F	LU45, LB45

VDI para unidade de fixação Coromant Capto®

Interface VDI no lado da máquina de acordo com DIN 69880

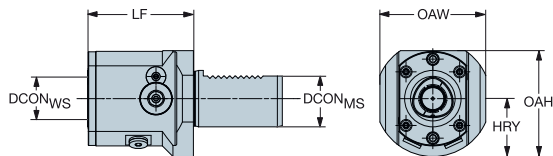

B

C

				Dimensões, mm												
CZC _{MS}	CZC _{WS}	CNSC	CXSC	Código para pedido	DCON _{MS}	DCON _{WS}	LF	OAW	OAH	HRY	BAR	NM	KG			
30	C3	6	2	C3-R/LC2030-00060M	30	32	60	50	61	34	80	35	1.4			
40	C4	6	2	C4-R/LC2040-00075M	40	40	75	75	75	41	80	50	2.4			
	C5	6	2	C5-R/LC2040-00085M	40	50	85	75	82	41	80	70	3.5			
50	C4	6	2	C4-R/LC2050-00065M	50	40	65	70	83	49	80	50	2.8			
	C5	6	2	C5-R/LC2050-00085M	50	50	85	83	90	49	80	70	4.5			
60	C5	6	2	C5-R/LC2060-00075M	60	50	75	80	100	58	80	70	5.7			
	C6	6	2	C6-R/LC2060-00095	60	63	95	84	111	58	80	90	7.4			

D

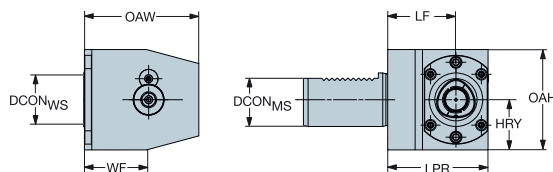
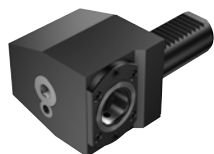

E

				Dimensões, mm												
CZC _{MS}	CZC _{WS}	CNSC	CXSC	Código para pedido	DCON _{MS}	DCON _{WS}	LPR	LF	WF	OAW	OAH	HTB	HRY	BAR	NM	KG
30	C3	6	2	C3-R/LC2030-41020M	30	32	60	41	20.0	74	57	38	30	80	35	2.2
		6	2	C3-R/LC2030-41030M	30	32	60	41	30.0	74	57	41	30	80	35	2.2
40	C4	6	2	C4-R/LC2040-51030M	40	40	75	51	30.0	86	75	54	38	80	50	3.9
		6	2	C4-R/LC2040-51040M	40	40	75	51	40.0	86	75	60	38	80	50	4.2
		6	2	C5-R/LC2040-53030M	40	50	85	53	30.0	99	82	47	41	80	70	4.8
50	C5	6	2	C5-R/LC2040-53040M	40	50	85	53	40.0	99	82	53	41	80	70	5.1
		6	2	C5-R/LC2050-53030M	50	50	85	53	30.0	99	86	59	43	80	70	6.3
		6	2	C5-R/LC2050-53040M	50	50	85	53	40.0	99	86	65	43	80	70	6.5
60	C5	6	2	C5-R/LC2060-43040M	60	50	75	43	40.0	99	94	76	53	80	70	7.3
		6	2	C6-R/LC2060-53040	60	63	95	53	40.0	122	105	70	53	80	90	9.8

Para componentes, visite www.sandvik.coromant.com

Nota! Aperte o parafuso com um torquímetro. Informações à página G16.

R = versão direita, L = versão esquerda

Mostrado versão direita

G

H



G1



H36



H5



E18

VDI para unidade de fixação Coromant Capto®

Interface VDI no lado da máquina de acordo com DIN 69880

Fixação por parafuso central

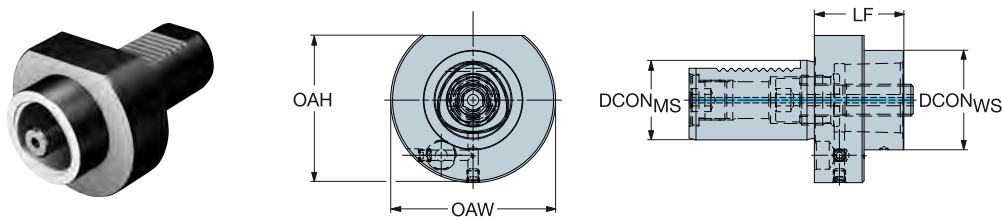

				Dimensões, mm										
CZC _{MS}	CZC _{WS}	CNSC	CXSC	Código para pedido	DCON _{MS}	DCON _{WS}	BD ₁	LB ₁	LF	OAW	OAH	BAR	NM	KG
30	C3	7	1	C3-NC3000-V30-035	30.0	32.0	32.0	15.0	35.0	68.0	62.0	80	45.0	0.8
	C4	7	1	C4-NC3000-V30-060	30.0	40.0	40.0	40.0	60.0	68.0	62.0	80	55.0	0.9
40	C3	7	1	C3-NC3000-V40-030	40.0	32.0	40.0	10.0	30.0	83.0	74.0	80	45.0	1.4
	C4	7	1	C4-NC3000-V40-030	40.0	40.0	40.0	5.0	30.0	83.0	74.0	80	55.0	1.5
	C5	7	1	C5-NC3000-V40-045	40.0	50.0	50.0	20.0	45.0	83.0	74.0	80	95.0	1.6
50	C6	7	1	C6-NC3000-V40-090	40.0	63.0	63.0	70.0	90.0	83.0	74.0	80	170.0	2.5
	C3	7	1	C3-NC3000-V50-035	50.0	32.0	32.0	10.0	35.0	98.0	84.0	80	45.0	2.4
	C4	7	1	C4-NC3000-V50-040	50.0	40.0	40.0	15.0	40.0	98.0	84.0	80	55.0	2.5
	C5	7	1	C5-NC3000-V50-050	50.0	50.0	50.0	25.0	50.0	98.0	84.0	80	95.0	2.6
	C6	7	1	C6-NC3000-V50-070	50.0	63.0	63.0	45.0	70.0	98.0	84.0	80	170.0	3.1
60	C8	7	1	C8-NC3000-V50-100	50.0	80.0	80.0	75.0	100.0	98.0	90.0	80	170.0	4.5
	C5	7	1	C5-NC3000-V60-050	60.0	50.0	50.0	20.0	50.0	123.0	104.0	80	95.0	4.3
	C6	7	1	C6-NC3000-V60-050	60.0	63.0	63.0	20.0	50.0	123.0	104.0	80	170.0	4.2
	C8	7	1	C8-NC3000-V60-085	60.0	80.0	80.0	55.0	85.0	123.0	104.0	80	170.0	5.7

Interface no lado da máquina de acordo com DIN 69881

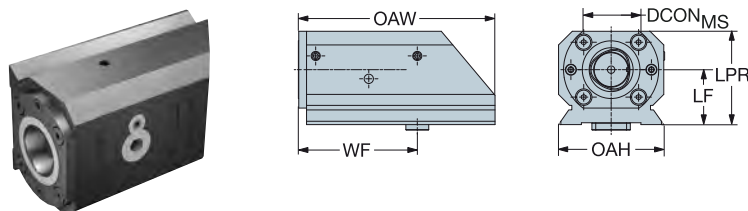

				Dimensões, mm										
CZC _{MS}	CZC _{WS}	CNSC	CXSC	Código para pedido	DCON _{WS}	LPR	LF	WF	OAW	OAH	BAR	NM	KG	
90	C5	2	2	C5-R/LC090-130L	50	82	50	130.0	210	90	80	70	9.7	
115	C6	2	2	C6-R/LC115-130L	63	102	60	130.0	215	115	80	90	16.7	
140	C6	2	2	C6-R/LC140-165L	63	102	60	165.0	310	140	80	90	25.0	
				C6-R/LC140-205L	63	102	60	205.0	350	140	80	90	28.2	
140	C8	2	2	C8-R/LC140-165L	80	120	70	135.0	310	140	80	130	30.3	
				C8-R/LC140-205L	80	120	70	165.0	350	140	80	130	35.1	

Para componentes, visite www.sandvik.coromant.com

N = neutra, R = versão direita, L = versão esquerda
Mostrado versão direita



G1



H36



H5



VDI para adaptador CoroTurn® SL

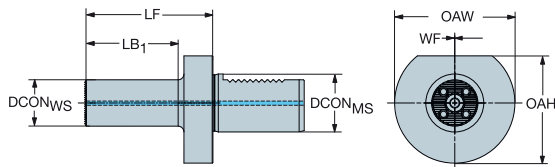

Dimensões, mm

CZC _{MS}	CZC _{WS}	CNSC	CXSC	Código para pedido	DCON _{MS}	DCON _{WS}	OAW	LF	LB ₁	BAR	NM	KG
30	32	7	1	VDI30-32-SL32N 088	30.0	32.0	68	88.0	64.0	150	35.00	1.25
40	32	7	1	VDI40-32-SL32N 088	40.0	32.0	83	88.0	64.0	150	50.00	1.80
40	40	7	1	VDI40-40-SL40N 104	40.0	40.0	83	104.0	80.0	150	50.00	2.20
50	40	7	1	VDI50-40-SL40N 109	50.0	40.0	98	109.0	80.0	150	50.00	3.30

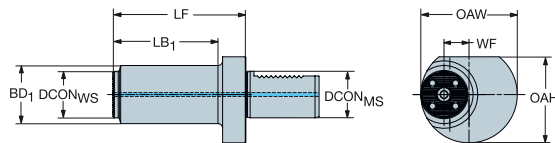

Dimensões, mm

CZC _{MS}	CZC _{WS}	CNSC	CXSC	Código para pedido	DCON _{MS}	DCON _{WS}	OAW	LF	WF	LB ₁	BD ₁	BAR	NM	KG
40	40	7	1	VDI40-50-SL40R/L 114	40.0	40.0	83	114.0	21	90.0	50.0	150	50.00	2.80
50	40	7	1	VDI50-50-SL40R/L 119	50.0	40.0	98	119.0	29	90.0	50.0	150	50.00	3.85
60	40	7	1	VDI50-60-SL40R/L 119	60.0	40.0	123	119.0	41	90.0	60.0	150	90.00	4.45

Para componentes, visite www.sandvik.coromant.com

R = versão direita, L = versão esquerda



VDI para CoroChuck™ 935

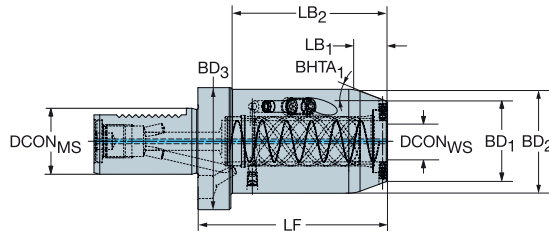

				Dimensões, mm																
CZC _{MS}	CZC _{WS}	CNSC	CXSC	Código para pedido	DCON _{MS}	DCON _{WS}	LSC	LF	LB ₁	LB ₂	BD ₁	BD ₂	BD ₃	BHTA ₁	BAR	NM	KG			
40	20	1	1	935-VDI40-EF20-090	40.0	20.0	80	90.0	18.0	70.0	43.9	57.0	83.0	20°	80	10.00	2.38			
	25	1	1	935-VDI40-EF25-115	40.0	25.0	100	115.0	20.0	95.0	48.4	63.0	83.0	20°	80	10.00	3.07			
50	20	1	1	935-VDI50-EF20-070	50.0	20.0	80	70.0	18.0	45.0	43.9	57.0	98.0	20°	80	10.00	2.98			
	25	1	1	935-VDI50-EF25-100	50.0	25.0	100	100.0	20.0	75.0	48.4	63.0	98.0	20°	80	10.00	3.67			

Para a lista completa de componentes, acesse www.sandvik.coromant.com



H36



H5



VDI para adaptador de haste retangular

Interface no lado da máquina de acordo com DIN 69880

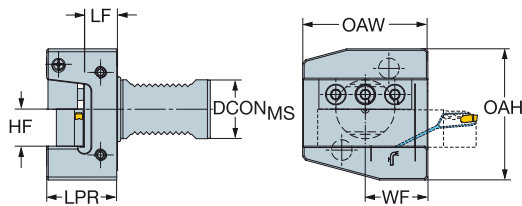

Dimensões, mm

CZC _{MS}	CZC _{WS}	CNSC	CXSC	Código para pedido	DCON _{MS}	LPR	LF	WF	HF	OAW	OAH	BAR	NM	KG
30	20 x 20	6	6	ASHA-R/L-VDI30-20-HP	30.0	35.5	15.5	35.0	20.0	70.0	73.0	80	10	1.3
40	25 x 25	6	6	ASHA-R/L-VDI40-25-HP	40.0	48.0	23.0	42.5	25.0	85.0	89.0	80	25	2.6
50	25 x 25	6	6	ASHA-R/L-VDI50-25-HP	50.0	48.0	23.0	50.0	25.0	100.0	110.0	80	25	4.4

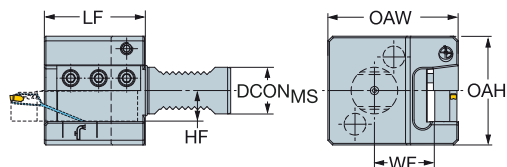

Dimensões, mm

CZC _{MS}	CZC _{WS}	CNSC	CXSC	Código para pedido	DCON _{MS}	LF	WF	HF	OAW	OAH	RADH	RADW	BAR	NM	KG
30	20 x 20	6	6	ASHN-VDI30-20-HP	30.0	70.0	35.5	20.0	85.5	70.0	35.0	55.5	80	10	2.0
40	25 x 25	6	6	ASHN-VDI40-25-HP	40.0	85.0	25.5	25.0	92.5	88.0	44.0	50.5	80	25	3.2

Para componentes, visite www.sandvik.coromant.com

N = neutra, R = versão direita, L = versão esquerda
Mostrado versão direita



VDI para adaptador de lâminas

Interface no lado da máquina de acordo com DIN 69880

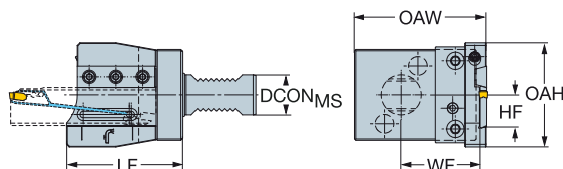

				Dimensões, mm												
CZC _{MS}	CZC _{WS}	CNSC	CXSC	Código para pedido	DCON _{MS}	LF	WF	HF	OAW	OAH	BAR	NM	KG			
25	21L	6	2	APBL-VDI25-21-HP	25.0	80.0	38.0	21.4	84.0	73.0	80	10	1.4			
	21R	6	2	APBR-VDI25-21-HP	25.0	80.0	38.0	21.4	84.0	73.0	80	10	1.4			
30	25L	6	2	APBL-VDI30-25-HP	30.0	87.0	46.0	25.0	98.5	78.0	80	10	1.9			
	25R	6	2	APBR-VDI30-25-HP	30.0	87.0	46.0	25.0	98.5	78.0	80	10	1.7			
40	25L	6	2	APBL-VDI40-25-HP	40.0	80.0	67.5	25.0	118.5	100.0	80	10	3.2			
	25R	6	2	APBR-VDI40-25-HP	40.0	80.0	67.5	25.0	118.5	100.0	80	10	3.2			

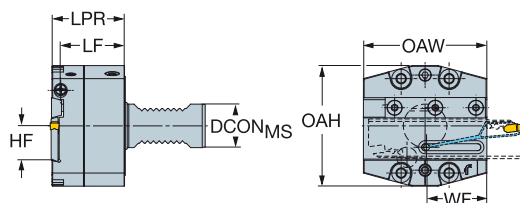
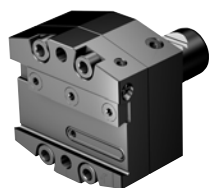

				Dimensões, mm												
CZC _{MS}	CZC _{WS}	CNSC	CXSC	Código para pedido	DCON _{MS}	LPR	LF	WF	HF	OAW	OAH	BAR	NM	KG		
30	25L	6	3	APBA-L-VDI30-25-HP	30.0	50.5	45.5	42.5	25.0	85.0	83.0	80	10	2.7		
	25R	6	3	APBA-R-VDI30-25-HP	30.0	50.5	45.5	42.5	25.0	85.0	83.0	80	10	2.7		
40	25L	6	3	APBA-L-VDI40-25-HP	40.0	50.5	45.5	42.5	25.0	85.0	83.0	80	10	3.0		
	25R	6	3	APBA-R-VDI40-25-HP	40.0	50.5	45.5	42.5	25.0	85.0	83.0	80	10	2.9		
50	25L	6	3	APBA-L-VDI50-25-HP	50.0	50.5	45.5	42.5	25.0	85.0	92.0	80	10	3.6		
	25R	6	3	APBA-R-VDI50-25-HP	50.0	50.5	45.5	42.5	25.0	85.0	92.0	80	10	3.6		

Para componentes, visite www.sandvik.coromant.com

R = versão direita, L = versão esquerda
Mostrado versão direita



VDI para adaptador VL

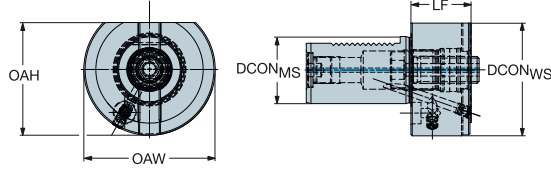
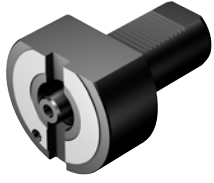

C

					Dimensões, mm							
CZC _{MS}	CZC _{WS}	CNSC	CXSC	Código para pedido	DCON _{MS}	DCON _{WS}	LF	OAW	OAH	BAR	NM	KG
50	80	7	1	VL80-NC3000-V50	50.0	80.0	45.0	98.0	84.0	80	190	3.2
60	80	7	1	VL80-NC3000-V60	60.0	80.0	45.0	123.0	104.5	80	190	5.4

Para componentes, visite www.sandvik.coromant.com

N = neutra

D

E

F

G

H



Bloco de ferramenta para lâminas

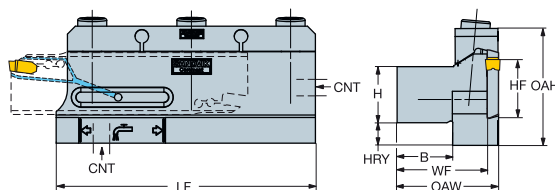

						Dimensões, mm											(BAR)	(KG)
CZC _{MS}	CZC _{WS}	OHX	CNSC	CXSC	Código para pedido	B	H	LF	WF	HF	OAW	OAH	RADW	CNT				
20 x 20	21L	5.0	2	2	BA-LGC2020-21M	20.0	20.0	85.0	34.0	20.0	39.0	46.0	39.0	G 1/8-28	70	0.7		
	25L	5.0	2	2	BA-LGC2020-25M	20.0	20.0	115.0	35.0	20.0	40.0	51.0	40.0	G 1/8-28	70	1.1		
	21R	5.0	2	2	BA-RGC2020-21M	20.0	20.0	85.0	34.0	20.0	39.0	46.0	39.0	G 1/8-28	70	0.7		
	25R	5.0	2	2	BA-RGC2020-25M	20.0	20.0	115.0	35.0	20.0	40.0	51.0	40.0	G 1/8-28	70	1.1		
25 x 25	21L	5.0	2	2	BA-LGC2525-21M	25.0	25.0	85.0	39.0	25.0	44.0	48.0	44.0	G 1/8-28	70	0.9		
	25L	5.0	2	2	BA-LGC2525-25M	25.0	25.0	115.0	40.0	25.0	45.5	52.0	45.5	G 1/8-28	70	1.3		
	21R	5.0	2	2	BA-RGC2525-21M	25.0	25.0	85.0	39.0	25.0	44.0	48.0	44.0	G 1/8-28	70	0.8		
	25R	5.0	2	2	BA-RGC2525-25M	25.0	25.0	115.0	40.0	25.0	45.5	52.0	45.5	G 1/8-28	70	1.3		
32 x 32	25L	5.0	2	2	BA-LGC3232-25M	32.0	32.0	115.0	46.0	32.0	52.5	54.0	52.5	G 1/8-28	70	1.6		
	45L	5.0	2	2	BA-LGC3232-45	32.0	32.0	155.0	47.0	45.0	55.0	77.0	55.0	G 1/8-28	70	2.9		
	25R	5.0	2	2	BA-RGC3232-25M	32.0	32.0	115.0	46.0	32.0	52.5	54.0	52.5	G 1/8-28	70	1.6		
	45R	5.0	2	2	BA-RGC3232-45	32.0	32.0	155.0	47.0	45.0	55.0	77.0	55.0	G 1/8-28	70	2.9		
40 x 40	45L	5.0	2	2	BA-LGC4040-45	40.0	40.0	155.0	55.0	45.0	63.0	77.0	63.0	G 1/8-28	70	3.5		
	45R	5.0	2	2	BA-RGC4040-45	40.0	40.0	155.0	55.0	45.0	63.0	77.0	63.0	G 1/8-28	70	3.5		

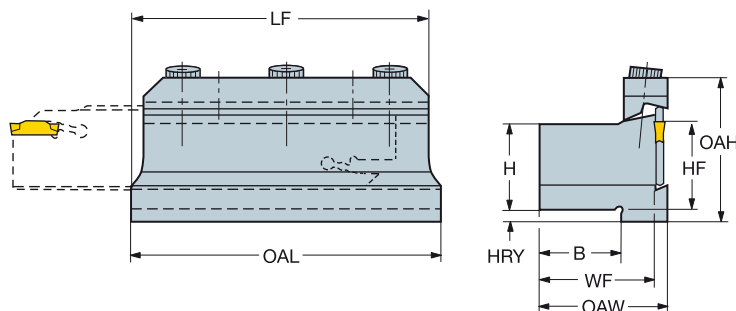

					Dimensões, mm											(KG)
CZC _{MS}	CZC _{WS}	OHX	DSGN	Código para pedido	B	H	LF	WF	HF	OAW	OAH	RADH	RADW			
20 x 20	21	5.0	1	151.2-2020-21M	20.0	20.0	80.0	33.0	20.0	38.0	45.5	20.0	13.4	0.6		
	25	5.0	1	151.2-2020-25	20.0	20.0	120.0	33.1	25.0	38.1	52.5	20.0	13.5	1.0		
25 x 20	21	5.0	1	151.2-2520-21	20.0	25.0	80.0	33.1	25.0	38.1	45.5	25.0	13.5	0.6		
	25	5.0	1	151.2-2520-25	20.0	25.0	120.0	33.0	25.0	38.0	52.5	25.0	13.4	1.1		
32 x 32	25	5.0	1	151.2-3232-25	32.0	32.0	120.0	45.0	32.0	50.0	54.5	32.0	13.4	1.6		
	45	5.0	1	151.2-3232-45	32.0	32.0	160.0	45.0	32.0	52.0	82.5	32.0	13.4	2.9		
40 x 40	45	5.0	1	151.2-4040-45	40.0	40.0	160.0	53.0	40.0	60.0	82.5	40.0	13.4	3.6		
	93	0.0	1	151.2-5050-93	50.0	50.0	178.0	68.5	50.5	78.1	152.3	50.0	13.5	8.2		

Para componentes, visite www.sandvik.coromant.com

R = versão direita, L = versão esquerda

Mostrado versão direita



H36



H5



Unidade de fixação Coromant Capto® para haste retangular

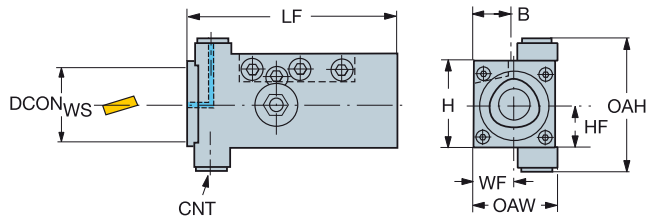

Dimensões, mm

CZC _{MS}	CZC _{WS}	CNSC	CXSC	Código para pedido	DCON _{WS}	B	H	LF	WF	HF	OAW	OAH	CNT	BAR	NM	KG
40 x 20	C3	2	2	C3-R/LC2085-4038M	32	20	40	95	19.0	20	38	62	G 1/8-28	80	35	1.3
50 x 25	C4	2	2	C4-R/LC2085-5048	40	25	50	125	24.0	25	48	58	G 1/8-28	80	50	2.3
64 x 32	C5	2	2	C5-R/LC2085-6464	50	32	64	146	32.0	32	64	72	G 1/8-28	80	70	4.4

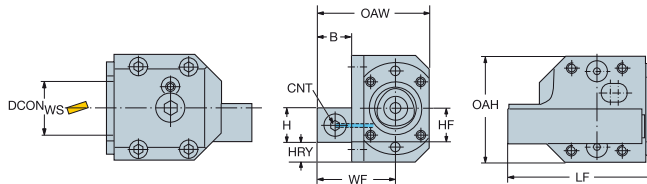
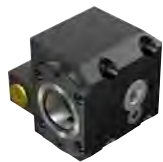

Dimensões, mm

CZC _{MS}	CZC _{WS}	CNSC	CXSC	Código para pedido	DCON _{WS}	B	H	LF	WF	HF	OAW	OAH	HRV	CNT	BAR	NM	KG
25 x 26	C4	1	2	C4-R/LC2080-59110A	40	26	25	110	59.0	25	83	77	13	G 1/4-19	80	50	2.9
32 x 33.5	C5	1	2	C5-R/LC2080-77110A	50	33	32	110	77.0	32	109	92	14	G 1/4-19	80	70	5.1
40 x 40	C6	1	2	C6-R/LC2080-93140	63	40	40	140	93.0	40	135	105	13	G 1/4-19	80	90	11.4

Para componentes, visite www.sandvik.coromant.com

R = versão direita, L = versão esquerda
Mostrado versão direita



G1



H36



H5

Unidade de fixação Coromant Capto® para haste cilíndrica com planos

Haste cilíndrica com planos para Coromant Capto®

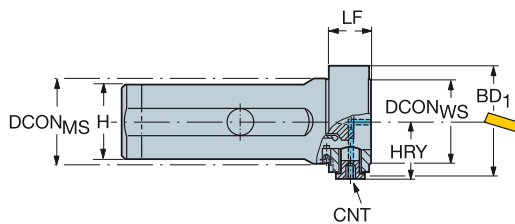

Fixação segmentada

				Dimensões, mm											
CZC _{MS}	CZC _{WS}	CNSC	CXSC	Código para pedido	DCON _{MS}	DCON _{WS}	H	LF	OAW	OAH	HRY	CNT	BAR	NM	KG
32	C3	2	2	C3-NC2000-08018-32	32	32	30	18	45	45	26	G 1/8-28	80	35	0.6
40	C4	2	2	C4-NC2000-10020-40	40	40	37	20	51	51	28	G 1/8-28	80	50	1.1
50	C4	2	2	C4-NC2000-12020-50	50	40	47	20	51	51	28	G 1/8-28	80	50	1.6
	C5	2	2	C5-NC2000-12024-50	50	50	47	24	61	61	33	G 1/8-28	80	70	2.1
60	C5	2	2	C5-NC2000-14024-60	60	50	57	24	61	61	33	G 1/8-28	80	70	3.1

N = neutra

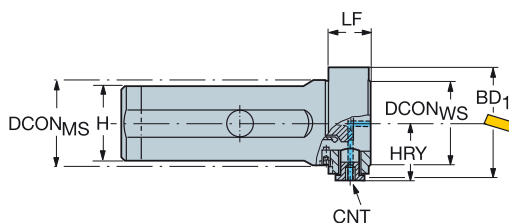
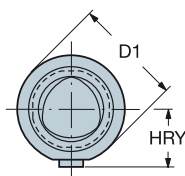

Parafuso central ativado

				Dimensões, mm										
CZC _{MS}	CZC _{WS}	CNSC	CXSC	Código para pedido	DCON _{MS}	DCON _{WS}	H	BD ₁	LF	CNT	BAR	NM	KG	
32	C3	2	2	C3-NC3000-08018-32	32.0	32.0	30.0	45.5	18.0	G 1/8-28	80	35	0.6	
40	C3	2	2	C3-NC3000-10018-40	40.0	32.0	37.0	45.5	18.0	G 1/8-28	80	35	1.1	
	C4	2	2	C4-NC3000-10020-40	40.0	40.0	37.0	51.5	20.0	G 1/8-28	80	50	1.1	
50	C5	2	2	C5-NC3000-12024-50	50.0	50.0	47.0	61.5	24.0	G 1/8-28	80	70	2.1	
60	C6	2	2	C6-NC3000-14054-60	60.0	63.0	57.0	70.0	54.0	G 1/8-28	80	85	4.2	

Para componentes, visite www.sandvik.coromant.com

N = neutra



G1



H36



H5

A

Haste cilíndrica com planos para adaptador VL

POR

B

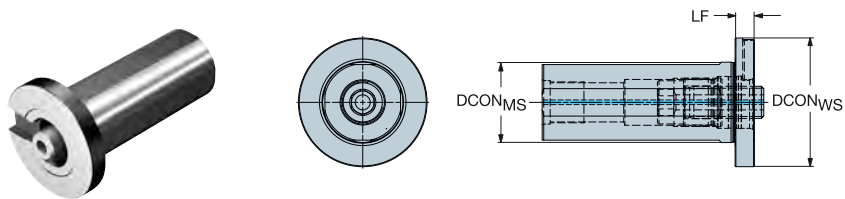

C

				Dimensões, mm							
CZC _{MS}	CZC _{WS}	CNSC	CXSC	Código para pedido	DCON _{MS}	DCON _{WS}	H	LF	BAR	NM	KG
50	80	1	1	VL80-NC3000-50	50.0	80.0	47.0	12.0	80	190	1.8
60	80	1	1	VL80-NC3000-60	60.0	80.0	57.0	12.0	80	190	3.0

Para componentes, visite www.sandvik.coromant.com

N = neutra

D

E

F

G

H



H36



H5

Unidade de fixação manual

Para aplicações especiais

Coromant Capto®

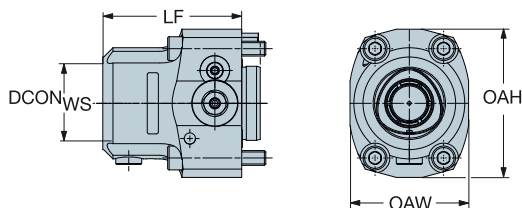

					Dimensões, mm									(BAR)	(NM)	(KG)
CZC _{MS}	CZC _{WS}	CNSC	CXSC	Código para pedido	DCON _{WS}	B	H	LF	OAW	OAH						
64 x 80	C5	6	1	C5-R/LC2095-00075	50	64	80	75	64	80	200	70	1.9			
74 x 135	C6	6	1	C6-R/LC2095-00090	63	74	135	90	74	135	200	90	4.3			
93 x 155	C8	6	1	C8-R/LC2095-00110	80	93	155	110	93	155	200	130	7.3			
126 x 208	C10	6	1	C10-R/LC2095-00182	100	126	208	182	126	208	200	285	19.6			

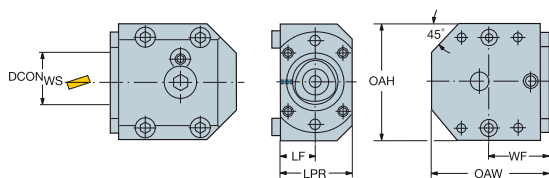

					Dimensões, mm											(BAR)	(NM)	(KG)
CZC _{MS}	CZC _{WS}	CNSC	CXSC	Código para pedido	DCON _{WS}	B	H	LPR	LF	WF	OAW	OAH						
73 x 54	C3	6	2	C3-R/LC2090-19039M	32	73	54	38	19	39.0	73	54	80	35	1.1			
86 x 77	C4	6	2	C4-R/LC2090-24043A	40	86	77	48	24	43.0	86	77	80	50	2.2			
100 x 92	C5	6	2	C5-R/LC2090-32048A	50	100	92	64	32	48.0	100	92	80	70	3.7			
122 x 105	C6	6	2	C6-R/LC2090-42060	63	122	105	84	42	60.0	122	105	80	90	7.0			
146 x 133	C8	6	2	C8-R/LC2090-50088	80	146	133	100	50	88.0	146	133	80	130	13.3			

Para componentes, visite www.sandvik.coromant.com

Nota! Aperte o parafuso com um torquímetro. Informações à página G16.

R = versão direita, L = versão esquerda

Mostrado versão direita



G1



H36



H5

VDI

Como escolher a ferramenta certa - CoroCut® QD

Versão da ferramenta

Axial
VDI
Lâmina

Como escolher a ferramenta certa

Versão direita ou versão esquerda
Ferramentas e adaptadores

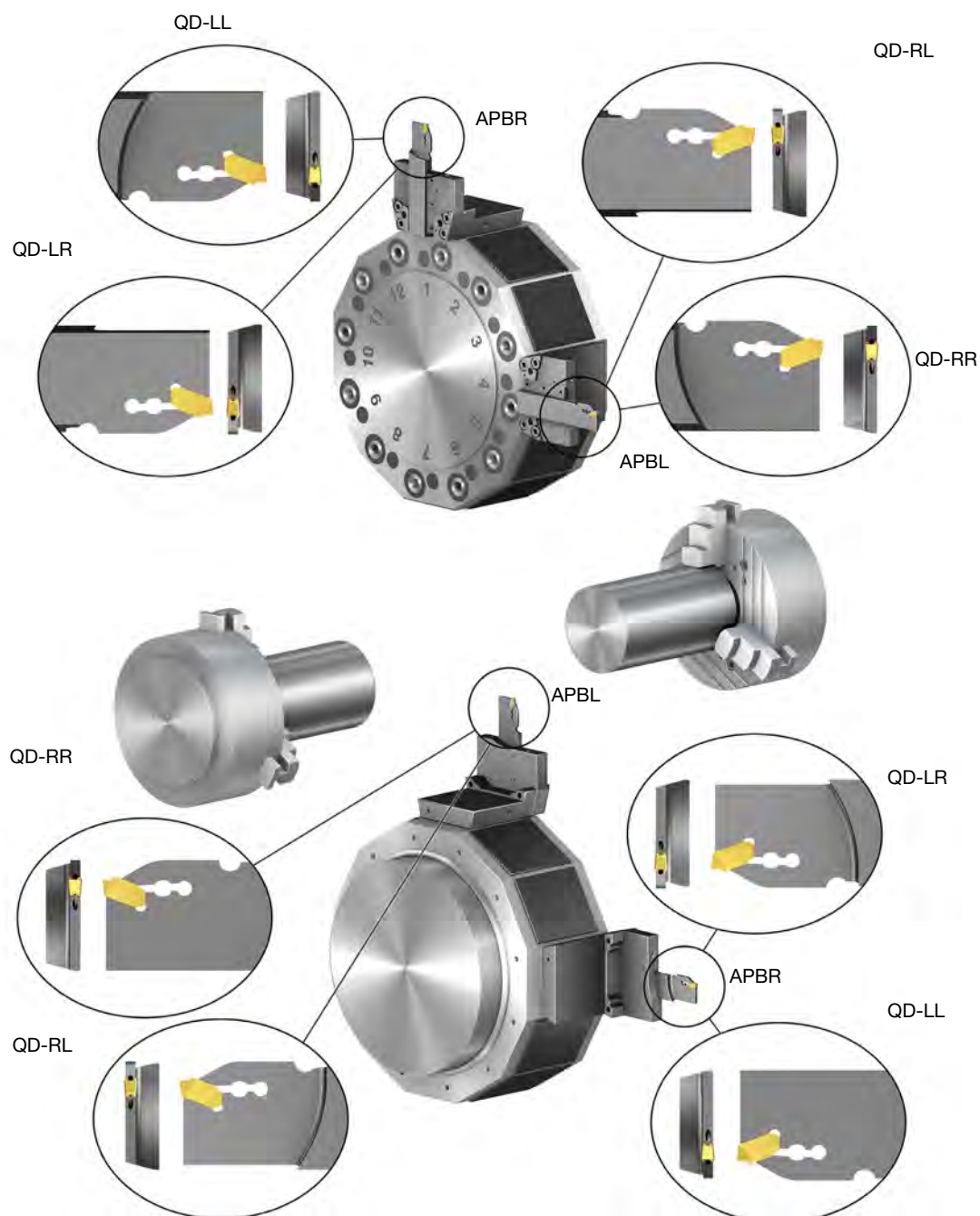

VDI

Como escolher a ferramenta certa

Versão da ferramenta

Radial

Lâmina VDI
Haste QS

Como escolher a ferramenta certa

Versão direita ou versão esquerda
Ferramentas e adaptadores

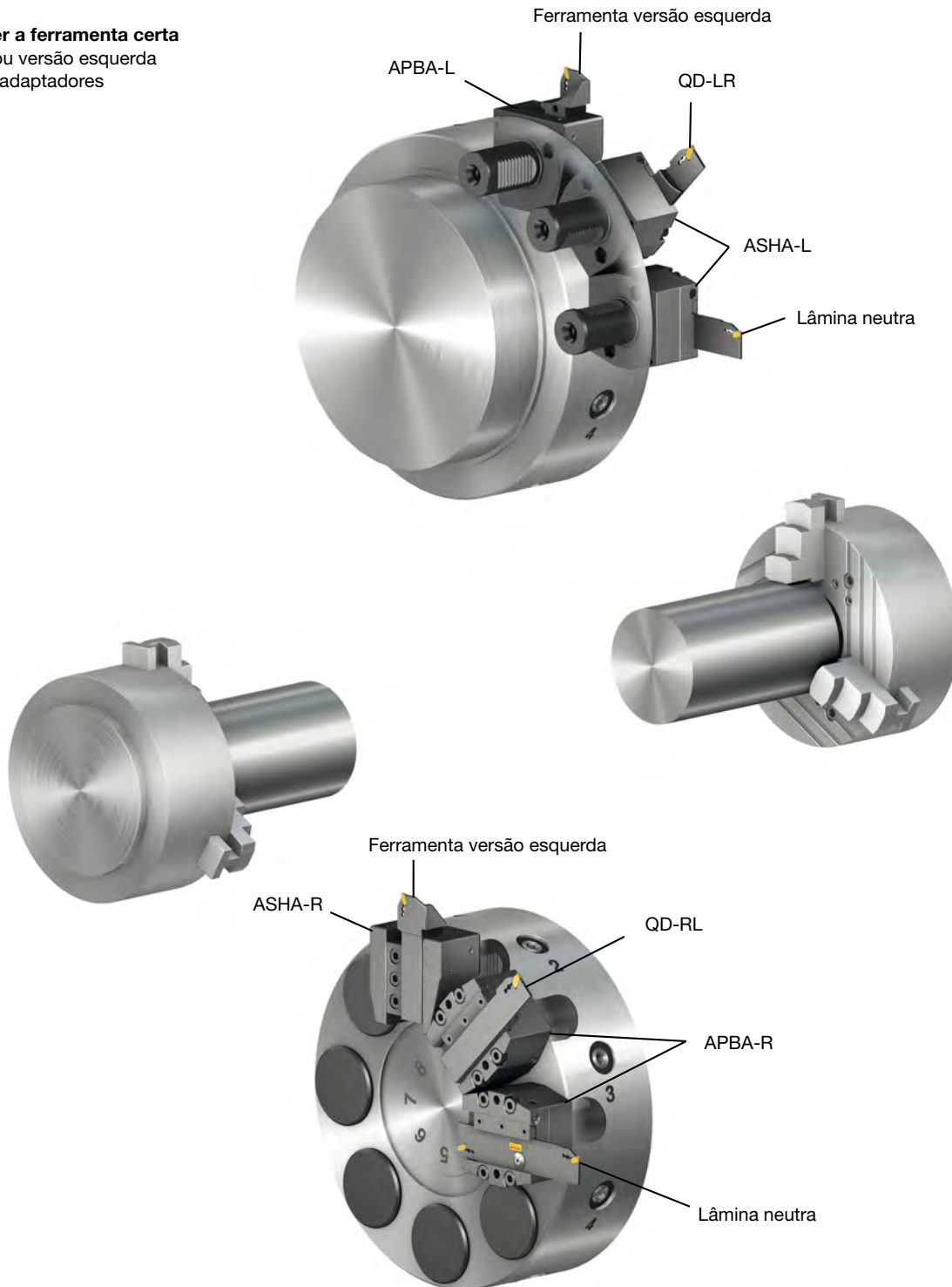

VDI

Como escolher a ferramenta certa - Coromant® Capto

Usinagem externa

Direção horária do fuso



Nota: A flange do polígono deve ser girada em 180°.

Direção anti-horária do fuso



Nota: A flange do polígono deve ser girada em 180°.

Usinagem interna

Direção horária do fuso



Nota: A flange do polígono deve ser girada em 180°.

Direção anti-horária do fuso



Nota: A flange do polígono deve ser girada em 180°.

Adaptadores para ferramentas de torneamento

Adaptadores convencionais

Coromant Capto®	F3-F23
HSK	F24-F29
Haste retangular	F31-F35
Haste cilíndrica	F36-F38
Haste cilíndrica com plano	F39-F45
CoroTurn® SL	F46-F50
Parafuso	F50

Adaptadores antivibratórios

Coromant Capto®	F54-F59
HSK	F61
Haste cilíndrica	F63-F66

Adaptadores convencionais

		Lado da máquina						
		Coromant Capto®	HSK	Haste retangular	Haste cilíndrica	Haste cilíndrica com planos	Parafuso	CoroTurn® SL
Lado da peça	Coromant Capto®	-Extensão -Redução -90° F3-F6						
	CoroTurn® SL	-Adaptador -Minitorre -SL70 F7-F16	-Adaptador -SL70	-Adaptador	-Adaptador	-Adaptador	-Adaptador	-Redução -Troca rápida -SL70 -Minitorre -570-80 para SL Troca Rápida F48-F50
	Haste retangular	-Adaptador -Mini-torre F17	-Adaptador F28					-Adaptador F52
	CoroChuck™ 935	-Adaptador F19	-Adaptador F29			-Adaptador F41		
	Haste cilíndrica	-Adaptador -EasyFix -Minitorre F20-F21	-Adaptador F30					
	CoroTurn® XS	-Adaptador F22		-Adaptador F33		-Adaptador -Dupla extremidade F42-F44		
	Lâmina	-Adaptador F23	-Adaptador F30					
	CoroCut® MB			-Adaptador F35	-Adaptador F38	-Adaptador F45		
	VL					-Adaptador E14		

Adaptadores antivibratórios

		Lado da máquina	
		Coromant Capto®	Haste cilíndrica
Lado da peça	Coromant Capto®		-Adaptador F63
	CoroTurn® SL	-Adaptador -Duas cabeças -Reforçado com metal duro -Elíptica F54-F59	-Adaptador -Reforçado com metal duro F63-F66
	CoroTurn® SL Troca Rápida	-Adaptador F59	-Adaptador -Reforçado com metal duro F66

Adaptador de extensão Coromant Capto®

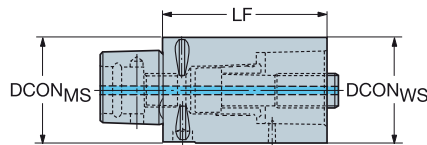

				Dimensões, mm						
CZC _{MS}	CZC _{WS}	CNSC	CXSC	Código para pedido	DCON _{MS}	DCON _{WS}	LF	BAR	NM	KG
C3	C3	3	1	C3-391.01-32 060A	32,0	32,0	60,0	80	45,00	0,36
				C3-391.01-32 080A	32,0	32,0	80,0	80	45,00	0,47
				C3-391.01-32 095	32,0	32,0	95,0	80	45,00	0,56
C4	C4	3	1	C4-391.01-40 060A	40,0	40,0	60,0	80	55,00	0,57
				C4-391.01-40 080A	40,0	40,0	80,0	80	55,00	0,70
				C4-391.01-40 120	40,0	40,0	120,0	80	55,00	1,11
C5	C5	3	1	C5-391.01-50 080A	50,0	50,0	80,0	80	95,00	1,15
				C5-391.01-50 100A	50,0	50,0	100,0	80	95,00	1,38
				C5-391.01-50 150	50,0	50,0	150,0	80	95,00	2,17
C6	C6	3	1	C6-391.01-63 100A	63,0	63,0	100,0	80	170,00	2,26
				C6-391.01-63 140A	63,0	63,0	140,0	80	170,00	3,17
				C6-391.01-63 185	63,0	63,0	185,0	80	170,00	4,19
C8	C8	3	1	C8-391.01-80 100A	80,0	80,0	100,0	80	170,00	3,70
				C8-391.01-80 125A	80,0	80,0	125,0	80	170,00	4,64
				C8-391.01-80 200	80,0	80,0	200,0	80	170,00	7,47
C10	C10	3	1	C10-391.01-100 140	100,0	100,0	140,0	80	380,00	7,93
				C10-391.01-100 200	100,0	100,0	200,0	80	380,00	11,49

Versão curta, somente para fixação por segmento

				Dimensões, mm						
CZC _{MS}	CZC _{WS}	CNSC	CXSC	Código para pedido	DCON _{MS}	DCON _{WS}	LF	BAR	NM	KG
C3	C3	3	1	C3-391.01-32 035	32,0	32,0	35,0	80	45,00	0,22
C4	C4	3	1	C4-391.01-40 040	40,0	40,0	40,0	80	55,00	0,40
C5	C5	3	1	C5-391.01-50 050	50,0	50,0	50,0	80	95,00	0,73
C6	C6	3	1	C6-391.01-63 060	63,0	63,0	60,0	80	170,00	1,36
C8	C8	3	1	C8-391.01-80 065	80,0	80,0	65,0	80	170,00	2,41

Versão curta, somente para fixação por segmento

Polígono rotacionado a 180°

				Dimensões, mm						
CZC _{MS}	CZC _{WS}	CNSC	CXSC	Código para pedido	DCON _{MS}	DCON _{WS}	LF	BAR	NM	KG
C5	C5	3	1	C5-391.01R-50 050	50,0	50,0	50,0	80	95,00	0,74
C6	C6	3	1	C6-391.01R-63 060	63,0	63,0	60,0	80	170,00	1,36
C8	C8	3	1	C8-391.01R-80 065	80,0	80,0	65,0	80	170,00	2,40

Para componentes, visite www.sandvik.coromant.com

Nota!

Não é possível usar suportes básicos e fixação por parafuso central.



G1



H36



H35



H5

Adaptador de redução Coromant Capto®

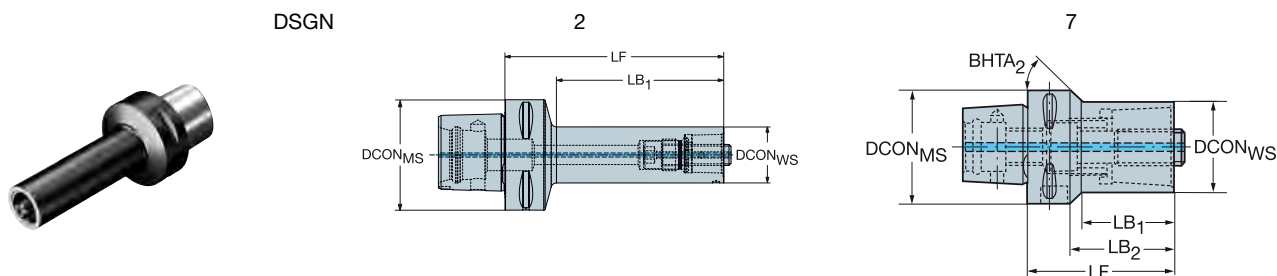

					Dimensões, mm													
CZC _{MS}	CZC _{WS}	CNSC	CXSC	DSGN	Código para pedido	DCON _{MS}	DCON _{WS}	LF	LB ₁	LB ₂	LB ₃	BD ₂	BD ₃	BHTA ₂	BAR	NM	KG	
C4	C3	3	1	2	C4-391.02-32 055A	40.0	32.0	55.0	31.0	55.0		40.0		0°	80	45.00	0.49	
	C3	3	1	2	C4-391.02-32 120	40.0	32.0	120.0	95.7	120.0		40.0		0°	80	45.00	0.81	
C5	C3	3	1	2	C5-391.02-32 060A	50.0	32.0	60.0	34.8	60.0		50.0		0°	80	45.00	0.68	
	C3	3	1	2	C5-391.02-32 120	50.0	32.0	120.0	94.4	120.0		50.0		0°	80	45.00	0.99	
	C4	3	1	2	C5-391.02-40 065A	50.0	40.0	65.0	40.0	65.0		50.0		0°	80	55.00	0.80	
C6	C4	3	1	2	C5-391.02-40 140	50.0	40.0	140.0	115.5	140.0		50.0		0°	80	55.00	1.46	
	C3	3	1	2	C6-391.02-32 070A	63.0	32.0	70.0	39.0	70.0		63.0		0°	80	45.00	1.12	
D	C3	3	1	2	C6-391.02-32 125	63.0	32.0	125.0	95.6	125.0		63.0		0°	80	45.00	1.43	
	C4	3	1	2	C6-391.02-40 080A	63.0	40.0	80.0	51.4	80.0		63.0		0°	80	55.00	1.32	
	C4	3	1	2	C6-391.02-40 145	63.0	40.0	145.0	116.7	145.0		63.0		0°	80	55.00	1.86	
	C5	3	1	2	C6-391.02-50 080A	63.0	50.0	80.0	51.5	80.0		63.0		0°	80	95.00	1.53	
	C5	3	1	2	C6-391.02-50 175	63.0	50.0	175.0	148.1	175.0		63.0		0°	80	95.00	2.79	
	C8	C3	3	1	2	C8-391.02-32 060B	80.0	32.0	60.0	20.7	60.0		80.0		0°	80	45.00	2.07
	C3	3	1	2	C8-391.02-32 135	80.0	32.0	135.0	95.7	135.0		80.0		0°	80	45.00	2.53	
E	C4	3	1	2	C8-391.02-40 070B	80.0	40.0	70.0	31.4	70.0		80.0		0°	80	55.00	2.20	
	C4	3	1	2	C8-391.02-40 155	80.0	40.0	155.0	116.4	155.0		80.0		0°	80	55.00	2.97	
	C5	3	1	2	C8-391.02-50 080B	80.0	50.0	80.0	42.8	80.0		80.0		0°	80	95.00	2.43	
	C5	3	1	2	C8-391.02-50 185	80.0	50.0	185.0	147.8	185.0		80.0		0°	80	95.00	3.88	
	C6	3	1	2	C8-391.02-63 080B	80.0	63.0	80.0	44.5	80.0		80.0		0°	80	170.00	2.65	
	C6	3	1	7	C8-391.02-63 120A	80.0	63.0	120.0	12.0	90.0	120.0	63.0	80.0	6°	80	170.00	4.10	
	C6	3	1	2	C8-391.02-63 200	80.0	63.0	200.0	164.5	200.0		80.0		0°	80	170.00	5.37	
F	C10	C3	3	1	7	C10-391.02-32 085	100.0	32.0	85.0	29.4	49.0	85.0	32.0	100.0	60°	80	45.00	4.15
	C4	3	1	7	C10-391.02-40 090	100.0	40.0	90.0	36.7	54.0	90.0	40.0	100.0	60°	80	55.00	4.25	
	C5	3	1	7	C10-391.02-50 095	100.0	50.0	95.0	44.6	59.0	95.0	50.0	100.0	60°	80	95.00	4.42	
	C6	3	1	7	C10-391.02-63 095	100.0	63.0	95.0	48.3	59.0	95.0	63.0	100.0	60°	80	170.00	4.68	
	C6	3	1	2	C10-391.02-63 200	100.0	63.0	200.0	155.8	200.0		100.0		0°	80	170.00	6.92	
	C8	3	1	7	C10-391.02-80 100	100.0	80.0	100.0	58.2	64.0	100.0	80.0	100.0	60°	80	170.00	5.25	
	C8	3	1	2	C10-391.02-80 200	100.0	80.0	200.0	158.1	200.0		100.0		0°	80	170.00	8.92	

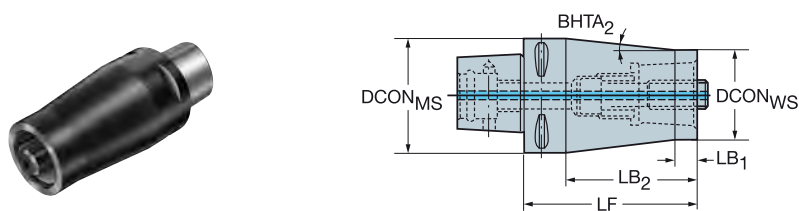

					Dimensões, mm												
CZC _{MS}	CZC _{WS}	CNSC	CXSC	Código para pedido	DCON _{MS}	DCON _{WS}	LF	LB ₁	LB ₂	BHTA ₂	BAR	NM	KG				
C4	C3	3	1	C4-391.02-32 070A	40.0	32.0	70.0	12.0	50.0	6°	80	45.00	0.59				
C5	C3	3	1	C5-391.02-32 150	50.0	32.0	150.0	5.0	128.2	8°	80	45.00	1.65				
	C4	3	1	C5-391.02-40 085A	50.0	40.0	85.0	12.0	65.0	5°	80	45.00	1.10				
C6	C3	3	1	C6-391.02-32 185	63.0	32.0	185.0	5.0	162.2	11°	80	45.00	2.99				
	C4	3	1	C6-391.02-40 185	63.0	40.0	185.0	5.0	162.2	8°	80	55.00	3.23				
C5	3	1	C6-391.02-50 110A	63.0	50.0	110.0	12.0	88.0	5°	80	95.00	2.23					
C8	C4	3	1	C8-391.02-40 200	80.0	40.0	200.0	5.0	169.2	13°	80	55.00	5.42				
	C5	3	1	C8-391.02-50 200	80.0	50.0	200.0	5.0	169.2	10°	80	95.00	5.84				

Para componentes, visite www.sandvik.coromant.com



Adaptador de redução Coromant Capto®

Versão curta, somente para fixação por segmento

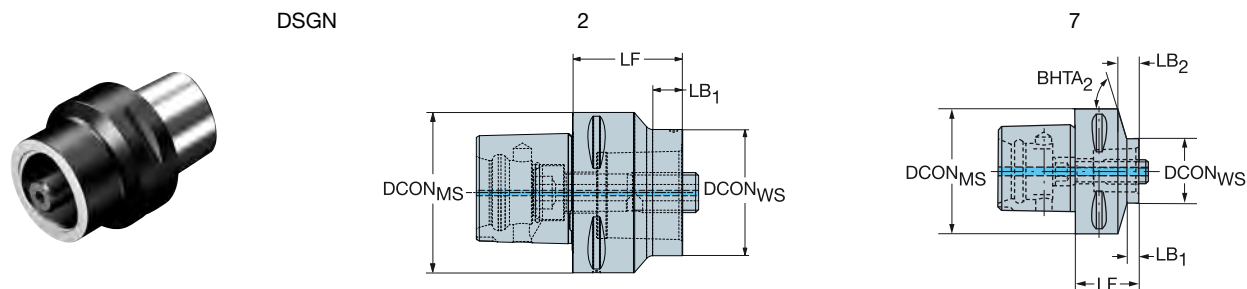

					Dimensões, mm												
CZC _{MS}	CZC _{WS}	CNSC	CXSC	DSGN	Código para pedido	DCON _{MS}	DCON _{WS}	LF	LB ₁	LB ₂	LB ₃	BD ₂	BD ₃	BHTA ₂	BAR	NM	KG
C5	C3	3	1	2	C5-391.02-32 033A	50.0	32.0	33.0	5.0	33.0		50.0		0°	80	45.00	0.54
	C4	3	1	2	C5-391.02-40 040A	50.0	40.0	40.0	15.0	40.0		50.0		0°	80	55.00	0.59
C6	C3	3	1	2	C6-391.02-32 032	63.0	32.0	32.0	6.0	32.0		63.0		0°	80	45.00	0.91
	C4	3	1	2	C6-391.02-40 040	63.0	40.0	40.0	11.0	40.0		63.0		0°	80	55.00	0.98
	C5	3	1	2	C6-391.02-50 050A	63.0	50.0	50.0	20.0	50.0		63.0		0°	80	95.00	1.11
C8	C5	3	1	2	C8-391.02-50 045A	80.0	50.0	45.0	5.0	45.0		80.0		0°	80	95.00	2.00
	C6	3	1	2	C8-391.02-63 055A	80.0	63.0	55.0	15.0	55.0		80.0		0°	80	170.00	2.15
C10	C6	3	1	7	C10-391.02-63 055	100.0	63.0	55.0	14.0	19.0	55.0	63.0	100.0	75°	80	170.00	3.70
	C8	3	1	7	C10-391.02-80 065	100.0	80.0	65.0	25.4	29.0	65.0	80.0	100.0	70°	80	170.00	3.92

Polígono rotacionado a 180°

					Dimensões, mm												
CZC _{MS}	CZC _{WS}	CNSC	CXSC	DSGN	Código para pedido	DCON _{MS}	DCON _{WS}	LF	LB ₁	BAR	NM	KG					
C8	C6	3	1	2	C8-391.02R-63 055A	80.0	63.0	55.0	15.0	80	170.00	2.13					

Para componentes, visite www.sandvik.coromant.com

Nota!

Não é possível usar suportes básicos e fixação por parafuso central.



G1



H36



H35



H5

Adaptador de redução Coromant Capto® deslocado

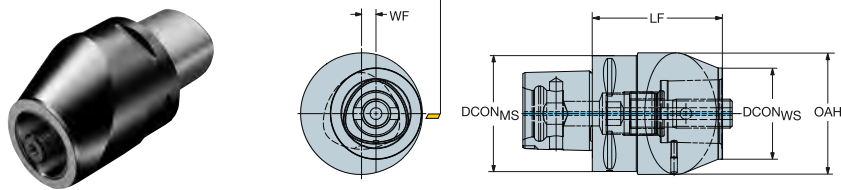

Apenas para fixação por segmento

		Dimensões, mm																
CZC _{MS}	CZC _{WS}	CNSC	CXSC	Código para pedido	DCON _{MS}	DCON _{WS}	LB ₁	LF	WF	OAW	OAH	RADH	RADW	DIX	BAR	NM	KG	
C8	C6	3	1	C8-391.02-63 090R/L	80.0	63.0	3.0	90.0	10.0	80.0	84.0	42.0	42.0	84	80	170.0	3.5	
C10	C8	3	1	C10-391.02-80 080R/L	100.0	80.0	3.0	80.0	13.0	100.0	107.0	53.5	53.5	107	80	170.0	5.2	

Não é possível usar suportes básicos e fixação por parafuso central.

Adaptador de redução Coromant Capto® deslocado com troca rápida

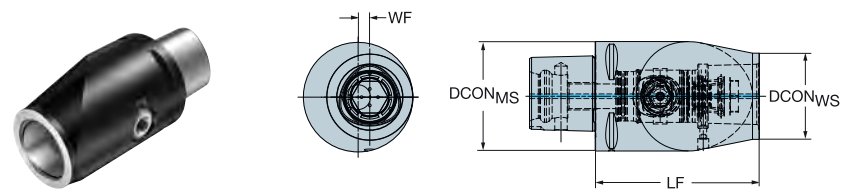

		Dimensões, mm																
CZC _{MS}	CZC _{WS}	CNSC	CXSC	DSGN	Código para pedido	DCON _{MS}	DCON _{WS}	LF	WF	BAR	NM	KG						
C6	C5	3	1	2	C6-QC-C5-100R/L07	63.0	50.0	100.0	6.5	150	70.0	2.0						
C8	C6	3	1	2	C8-QC-C6-120R/L09	80.0	63.0	120.0	8.5	150	90.0	4.2						
C10	C6	3	1	2	C10-QC-C6-125R19	100.0	63.0	125.0	18.5	150	130.0	6.2						

Adaptador de redução Coromant Capto® 90°

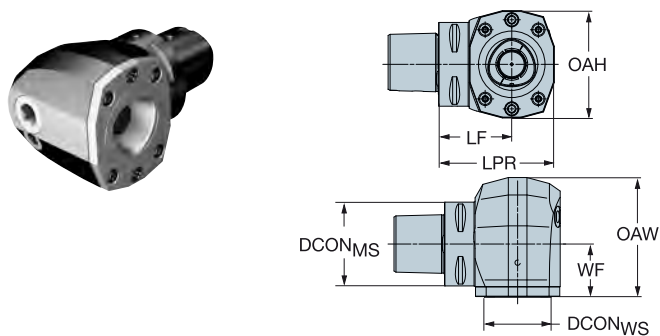

		Dimensões, mm																
CZC _{MS}	CZC _{WS}	CNSC	CXSC	Código para pedido	DCON _{MS}	DCON _{WS}	LPR	LF	WF	OAW	OAH	RADW	BAR	NM	KG			
C5	C4	3	1	C5-R/L-C4-L-44035	50.0	40.0	68.0	44.0	35.0	79.0	66.0	35.0	200	50.0	1.7			
		3	1	C5-R/L-C4-R-44035	50.0	40.0	68.0	44.0	35.0	79.0	66.0	35.0	200	50.0	1.7			
C6	C5	3	1	C6-R/L-C5-L-55040	63.0	50.0	87.0	55.0	40.0	90.0	81.0	40.0	200	70.0	3.1			
		3	1	C6-R/L-C5-R-55040	63.0	50.0	87.0	55.0	40.0	90.0	81.0	40.0	200	70.0	3.2			
C8	C6	3	1	C8-R/L-C6-L-72050	80.0	63.0	106.0	69.0	50.0	109.0	104.5	50.0	200	90.0	6.2			
		3	1	C8-R/L-C6-R-72050	80.0	63.0	106.0	69.0	50.0	109.0	104.5	50.0	200	90.0	6.2			

Para componentes, visite www.sandvik.coromant.com

R = versão direita, L = versão esquerda



Coromant Capto® para adaptador CoroTurn® SL

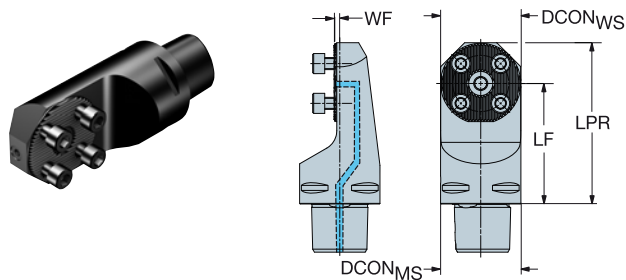

Para usinagem de canais frontais

				Dimensões, mm								
CZC _{MS}	CZC _{WS}	CNSC	CXSC	Código para pedido	DCON _{MS}	DCON _{WS}	LPR	LF	WF	BAR	NM	KG
C4	32	3	1	C4-SL-32-60-R/LF	40.0	32.0	76.3	60.0	6.5	150	8.8	0.5
C5	32	3	1	C5-SL-32-75-R/LF	50.0	32.0	91.3	75.0	11.5	150	8.8	0.9
C6	32	3	1	C6-SL-32-90-R/LF	63.0	32.0	106.3	90.0	16.5	150	8.8	1.5
	40	3	1	C6-SL-40-90-R/LF	63.0	40.0	110.3	90.0	12.5	150	17.0	1.6

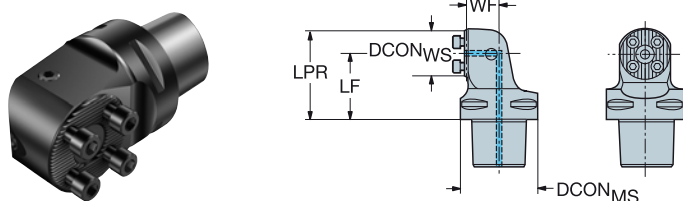

				Dimensões, mm								
CZC _{MS}	CZC _{WS}	CNSC	CXSC	Código para pedido	DCON _{MS}	DCON _{WS}	LPR	LF	WF	BAR	NM	KG
C4	25	3	1	C4-570-25-R/LF	40.0	25.0	49.8	37.0	13.0	70	3.7	0.3
	32	3	1	C4-570-32-R/LF	40.0	32.0	59.8	43.5	13.0	70	8.8	0.5
	40	3	1	C4-570-40-R/LF	40.0	40.0	68.8	48.5	13.0	70	17.0	0.6
C5	25	3	1	C5-570-25-R/LF	50.0	25.0	48.8	36.0	21.0	70	3.7	0.5
	32	3	1	C5-570-32-R/LF	50.0	32.0	58.3	42.0	21.0	70	8.8	0.7
	40	3	1	C5-570-40-R/LF	50.0	40.0	66.3	46.0	21.0	70	17.0	0.9
C6	32	3	1	C6-570-32-R/LF	63.0	32.0	54.8	38.5	31.0	70	8.8	1.0
	40	3	1	C6-570-40-R/LF	63.0	40.0	62.8	42.5	31.0	70	17.0	1.2
C8	32	3	1	C8-570-32-R/LF	80.0	32.0	62.3	46.0	41.0	70	8.8	2.0
	40	3	1	C8-570-40-R/LF	80.0	40.0	70.3	50.0	41.0	70	17.0	2.3

Para componentes, visite www.sandvik.coromant.com

R = versão direita, L = versão esquerda

Para corresponder com o tamanho do acoplamento, CZC_{WS} para cabeças CoroCut® SL e T-Max Q-Cut® SL respectivamente. 0° versão direita encaixa-se em cabeças versão esquerda, 45° versão direita encaixa-se em cabeças versão direita. 90° versão esquerda e direita encaixa-se em cabeças versão esquerda e direita. 90° versão neutra encaixa-se em cabeças versão direita e esquerda.



G1



H36



H5



H2

Coromant Capto® para adaptador CoroTurn® SL

DSGN

1

2

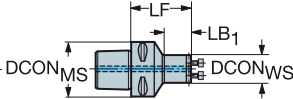
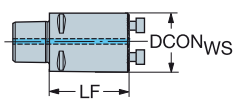

Dimensões, mm

CZC _{MS}	CZC _{WS}	CNSC	CXSC	DSGN	Código para pedido	DCON _{MS}	DCON _{WS}	LB ₁	LF	BAR	NM	KG
C3	32	3	1	1	C3-570-32-NG	32.0	32.0	22.0	22.0	150	8.8	0.1
C4	32	3	1	2	C4-570-32-NG	40.0	32.0	8.0	32.0	150	8.8	0.3
	40	3	1	1	C4-570-40-NG	40.0	40.0	32.0	32.0	150	17.0	0.4
C5	40	3	1	2	C5-570-40-NG	50.0	40.0	17.0	42.0	150	17.0	0.7
C6	40	3	1	2	C6-570-40-NG	63.0	40.0	16.0	47.0	150	17.0	1.1

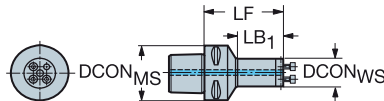

Dimensões, mm

CZC _{MS}	CZC _{WS}	OHX	CNSC	CXSC	Código para pedido	DCON _{MS}	DCON _{WS}	LB ₁	LF	BAR	NM	KG
C3	20	50.0	3	1	C3-570-2C 20 050	32.0	20.0	32.0	50.0	70	2.8	0.2
	25	64.0	3	1	C3-570-2C 25 064	32.0	25.0	46.0	64.0	70	3.7	0.3
	32	37.0	3	1	C3-570-2C 32 037	32.0	32.0	37.0	37.0	70	8.8	0.2
		53.0	3	1	C3-570-2C 32 053	32.0	32.0	53.0	53.0	70	8.8	0.4
C4	16	48.0	3	1	C4-570-2C 16 048	40.0	16.0	23.0	48.0	70	2.0	0.3
	20	58.0	3	1	C4-570-2C 20 058	40.0	20.0	34.0	58.0	70	2.8	0.4
	25	64.0	3	1	C4-570-2C 25 064	40.0	25.0	42.0	64.0	70	3.7	0.4
	32	74.0	3	1	C4-570-2C 32 074	40.0	32.0	51.0	74.0	70	8.8	0.6
	40	53.0	3	1	C4-570-2C 40 053	40.0	40.0	40.0	53.0	70	17.0	0.6
		73.0	3	1	C4-570-2C 40 073	40.0	40.0	73.0	73.0	70	17.0	0.8
C5	16	52.0	3	1	C5-570-2C 16 052	50.0	16.0	28.0	52.0	70	2.0	0.5
	20	59.0	3	1	C5-570-2C 20 059	50.0	20.0	33.0	59.0	70	2.8	0.6
	25	67.0	3	1	C5-570-2C 25 067	50.0	25.0	41.0	67.0	70	3.7	0.6
	32	75.0	3	1	C5-570-2C 32 075	50.0	32.0	48.0	75.0	70	8.8	0.8
	40	94.0	3	1	C5-570-2C 40 094	50.0	40.0	72.0	94.0	70	17.0	1.2
C6	16	56.0	3	1	C6-570-2C 16 056	63.0	16.0	28.0	56.0	70	2.0	0.9
	20	68.0	3	1	C6-570-2C 20 068	63.0	20.0	40.0	67.0	70	2.8	1.0
	25	82.0	3	1	C6-570-2C 25 082	63.0	25.0	55.0	82.0	70	3.7	1.1
	32	81.0	3	1	C6-570-2C 32 081	63.0	32.0	51.0	81.0	70	8.8	1.2
	40	92.0	3	1	C6-570-2C 40 092	63.0	40.0	63.0	92.0	70	17.0	1.4
C8	40	110.0	3	1	C8-570-2C 40 110	80.0	40.0	78.0	110.0	150	17.0	2.5

Para componentes, visite www.sandvik.coromant.com



G1



H36



H5



H2

Coromant Capto® para adaptador CoroTurn® SL



Cx-570-2C..R/L

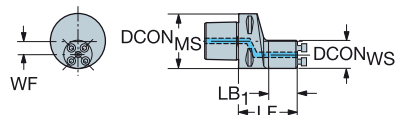

Cx-570-2C..R/L40

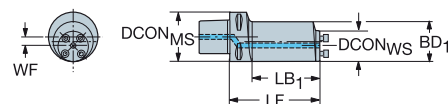

				Dimensões, mm									
CZC _{MS}	CZC _{WS}	CNSC	CXSC	Código para pedido	DCON _{MS}	DCON _{WS}	BD ₁	LB ₁	LF	WF	BAR	NM	KG
C4	16	3	1	C4-570-2C 16 041R/L	40.0	16.0	16.0	12.0	41.0	12.0	70	2	0.3
	20	3	1	C4-570-2C 20 047R/L	40.0	20.0	20.0	20.0	47.0	10.0	70	2	0.3
	25	3	1	C4-570-2C 25 051R/L	40.0	25.0	25.0	25.0	51.0	7.5	70	3	0.4
	32	3	1	C4-570-2C 32 056R/L	40.0	32.0	32.0	32.0	56.0	4.0	70	8	0.5
C5	20	3	1	C5-570-2C 20 050R	50.0	20.0	20.0	20.0	50.0	15.0	70	2	0.5
	25	3	1	C5-570-2C 25 054R/L	50.0	25.0	25.0	25.0	54.0	12.5	70	3	0.6
	32	3	1	C5-570-2C 32 061R/L	50.0	32.0	32.0	32.0	61.0	9.0	70	8	0.8
	40	3	1	C5-570-2C 40 075R/L	50.0	40.0	40.0	48.0	75.0	5.0	70	17	1.0
C6	25	3	1	C6-570-2C 25 056R/L	63.0	25.0	25.0	25.0	56.0	19.0	70	3	0.9
	32	3	1	C6-570-2C 32 066R/L	63.0	32.0	32.0	32.0	66.0	15.5	70	8	1.1
	40	3	1	C6-570-2C 40 080R/L	63.0	40.0	40.0	48.0	80.0	11.5	70	17	1.4
		3	1	C6-570-2C 50 097R/L40	63.0	40.0	50.0	68.0	97.0	12.0	70	17	1.9
		3	1	C6-570-2C 60 112R/L40	63.0	40.0	60.0	88.0	112.0	10.0	70	17	2.7
C8	40	3	1	C8-570-2C 40 089R/L	80.0	40.0	40.0	89.0	89.0	20.0	150	17	2.3

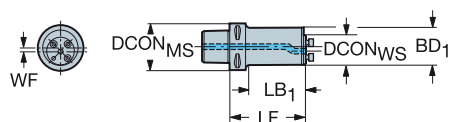

				Dimensões, mm									
CZC _{MS}	CZC _{WS}	CNSC	CXSC	Código para pedido	DCON _{MS}	DCON _{WS}	BD ₁	LB ₁	LF	WF	BAR	NM	KG
C5	40	3	1	C5-570-2C 50 073-40R/L	50.0	40.0	50.0	73.0	73.0	5.0	70	17	1.2
		3	1	C5-570-2C 50 098-40R/L	50.0	40.0	50.0	98.0	98.0	5.0	70	17	1.6
C6	40	3	1	C6-570-2C 50 124-40R/L	63.0	40.0	50.0	98.0	124.0	5.0	70	17	2.3
		3	1	C6-570-2C 60 148-40R/L	63.0	40.0	60.0	123.0	148.0	10.0	70	17	3.5
C8	40	3	1	C8-570-2C 50 107-40R/L	80.0	40.0	50.0	73.0	107.0	20.0	150	17	2.8
		3	1	C8-570-2C 50 133-40R/L	80.0	40.0	50.0	104.0	133.0	5.0	150	17	3.2
		3	1	C8-570-2C 60 125-40R/L	80.0	40.0	60.0	94.0	125.0	20.0	150	17	3.7
		3	1	C8-570-2C 60 158-40R/L	80.0	40.0	60.0	131.0	158.0	10.0	150	17	4.4

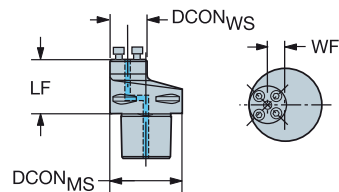

					Dimensões, mm							
CZC _{MS}	CZC _{WS}	OHX	CNSC	CXSC	Código para pedido	DCON _{MS}	DCON _{WS}	LF	WF	BAR	NM	KG
C5	32	42.0	3	1	C5-570-32-R/LG	50.0	32.0	42.0	9.0	150	8	0.6
	40	40.0	3	1	C5-570-40-R/LG	50.0	40.0	40.0	11.0	150	17	0.6
C6	32	47.0	3	1	C6-570-32-R/LG	63.0	32.0	47.0	15.5	150	8	1.0
	40	40.0	3	1	C6-570-40-R/LG	63.0	40.0	45.0	21.0	150	17	1.0
C8	32	66.0	3	1	C8-570-32-R/LGM	80.0	32.0	66.0	24.0	150	8	2.0
	40	67.0	3	1	C8-570-40-R/LGM	80.0	40.0	67.0	20.0	150	17	2.1
C10	40	78.0	3	1	C10-570-40-R/LG	100.0	40.0	78.0	30.0	150	17	4.1

Para componentes, visite www.sandvik.coromant.com

R = versão direita, L = versão esquerda



G1



H36



H5



H2

A

Coromant Capto® para adaptador CoroTurn® SL

Desenho específico adaptado à máquina

B

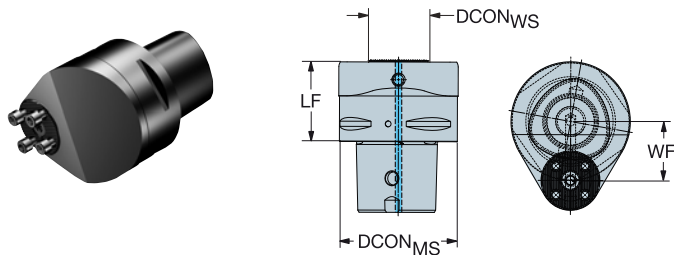

C

Mazak

				Dimensões, mm							
CZC _{MS}	CZC _{WS}	CNSC	CXSC	Código para pedido	DCON _{MS}	DCON _{WS}	LF	WF	BAR	NM	KG
C8	40	3	1	C8-570-40-LG-040-MZ	80.0	40.0	55.0	40.0	150	17.0	2.7

Mori Seiki - NT6600

D

				Dimensões, mm							
CZC _{MS}	CZC _{WS}	CNSC	CXSC	Código para pedido	DCON _{MS}	DCON _{WS}	LF	WF	BAR	NM	KG
C8	40	3	1	C8-570-40-RG-040-MS	80.0	40.0	55.0	40.0	150	17.0	2.8

Adaptado para tornos verticais

E

				Dimensões, mm							
CZC _{MS}	CZC _{WS}	CNSC	CXSC	Código para pedido	DCON _{MS}	DCON _{WS}	LF	WF	BAR	NM	KG
C6	40	3	1	C6-570-40-RG-045	63.0	40.0	62.0	45.0	150	17.0	1.8

Okuma Multus B750**WFL M100, M120, M150**

F

				Dimensões, mm							
CZC _{MS}	CZC _{WS}	CNSC	CXSC	Código para pedido	DCON _{MS}	DCON _{WS}	LF	WF	BAR	NM	KG
C8	40	3	1	C8-570-40-LG-040	80.0	40.0	55.0	40.0	150	17.0	2.7

Para componentes, visite www.sandvik.coromant.com

R = versão direita, L = versão esquerda

G

H



Coromant Capto® para adaptador CoroTurn® SL

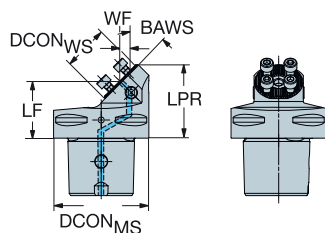

				Dimensões, mm								
CZC _{MS}	CZC _{WS}	CNSC	CXSC	Código para pedido	DCON _{MS}	DCON _{WS}	LPR	LF	WF	BAR	NM	KG
C5	32	3	1	C5-570-32-R/LX-045	50.0	32.0	45.0	34.0	6.0	70	8.8	0.5
C6	32	3	1	C6-570-32-R/LX-045	63.0	32.0	48.0	37.5	12.5	70	8.8	0.9
	40	3	1	C6-570-40-R/LX-045-060	63.0	40.0	74.0	60.0	14.5	150	17.0	1.2

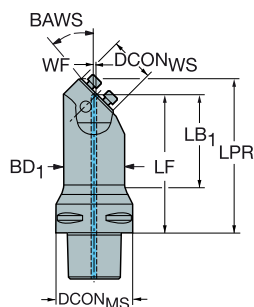

				Dimensões, mm										
CZC _{MS}	CZC _{WS}	CNSC	CXSC	Código para pedido	DCON _{MS}	DCON _{WS}	BD ₁	LB ₁	LPR	LF	WF	BAR	NM	KG
C5	32	3	1	C5-570-32-RX-045-L1	50.0	32.0	40.0	70.0	101.0	90.0	2.0	70	8.8	1.1
C6	32	3	1	C6-570-32-RX-045-L1	63.0	32.0	45.0	68.0	111.0	100.0	2.0	70	8.8	1.7
	40	3	1	C6-570-40-RX-045-L1	63.0	40.0	45.0	71.0	114.0	100.0	5.0	70	17.0	1.8
C8	40	3	1	C8-570-40-RX-045-L1	80.0	40.0	50.0	74.0	149.0	135.0	5.0	70	17.0	3.6

Para componentes, visite www.sandvik.coromant.com

R = versão direita, L = versão esquerda

Para corresponder com o tamanho do acoplamento, CZC_{WS} para cabeças CoroCut® SL e T-Max Q-Cut® SL respectivamente. 0° versão direita encaixa-se em cabeças versão esquerda, 45° versão direita encaixa-se em cabeças versão direita. 90° versão esquerda e direita encaixa-se em cabeças versão esquerda e direita. 90° versão neutra encaixa-se em cabeças versão direita e esquerda.



G1



H36



H5



H2

Coromant Capto® para adaptador CoroTurn® SL

Versão curta, somente para fixação por segmento

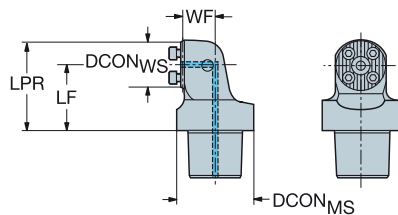

					Dimensões, mm							
CZC _{MS}	CZC _{WS}	CNSC	CXSC	Código para pedido	DCON _{MS}	DCON _{WS}	LPR	LF	WF	BAR	NM	KG
C3	25	3	1	C3-570-25-R/LF-T	32.0	25.0	36.3	23.5	17.0	70	3.7	0.2
	32	3	1	C3-570-32-R/LF-T	32.0	32.0	43.3	27.0	17.0	70	8.8	0.3
C4	32	3	1	C4-570-32-R/LF-T	40.0	32.0	43.3	27.0	20.0	70	8.8	0.4
	40	3	1	C4-570-40-R/LF-T	40.0	40.0	51.3	31.0	20.0	70	17.0	0.5
C5	32	3	1	C5-570-32-R/LF-T	50.0	32.0	43.3	27.0	27.0	70	8.8	0.5
	40	3	1	C5-570-40-R/LF-T	50.0	40.0	51.3	31.0	27.0	70	17.0	0.7

					Dimensões, mm							
CZC _{MS}	CZC _{WS}	CNSC	CXSC	Código para pedido	DCON _{MS}	DCON _{WS}	LPR	LF	WF	BAR	NM	KG
C4	32	3	1	C4-570-32-R/LX-045-T	40.0	32.0	33.0	22.0	1.0	70	8.8	0.3

Para componentes, visite www.sandvik.coromant.com

R = versão direita, L = versão esquerda

Para corresponder com o tamanho do acoplamento, CZC_{WS} para cabeças CoroCut® SL e T-Max Q-Cut® SL respectivamente. 0° versão direita encaixa-se em cabeças versão esquerda, 45° versão direita encaixa-se em cabeças versão direita. 90° versão esquerda e direita encaixa-se em cabeças versão esquerda e direita. 90° versão neutra encaixa-se em cabeças versão direita e esquerda.

Nota: Somente para fixação segmentada. Não pode ser usado em suportes básicos e extensão/reduções. Não pode ser usado para troca automática da ferramenta. Não tem canais para garras.



Minitorre Coromant Capto® para quatro cabeças CoroTurn® SL

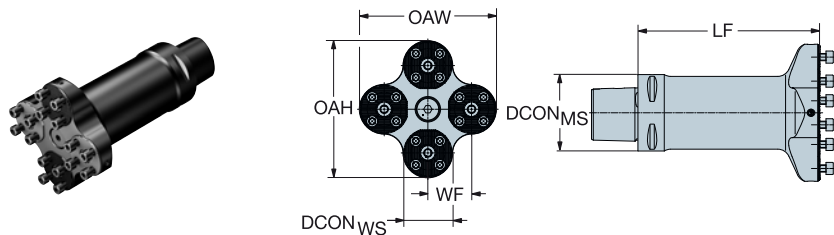

				Dimensões, mm									(BAR)	(NM)	(KG)
CZC _{MS}	CZC _{WS}	CNSC	CXSC	Código para pedido	DCON _{MS}	DCON _{WS}	LF	WF	OAW	OAH					
C6	40	3	1	C6-4-SL40 113 150-AX	63.0	40.0	150.0	36.0	113.0	113.0	150	17.0	4.4		
C8	40	3	1	C8-4-SL40 113 180-AX	80.0	40.0	180.0	36.0	113.0	113.0	150	17.0	6.1		

Barra de mandrilar para duas cabeças CoroTurn® SL

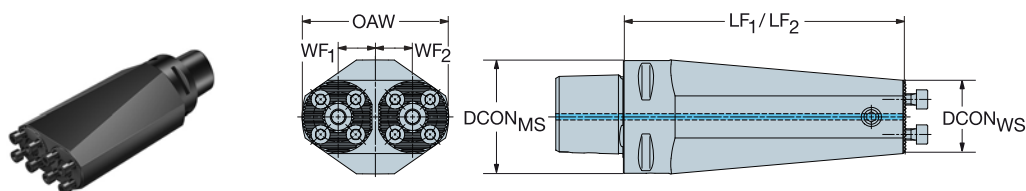

				Dimensões, mm										(BAR)	(NM)	(KG)
CZC _{MS}	CZC _{WS}	CNSC	CXSC	Código para pedido	DCON _{MS}	DCON _{WS}	LF	WF	OAW	DIX						
C6	32	3	1	C6-SL-2C65 150-32-2	63.0	32.0	150.0	16.5	65.0	65	70	8.8	3.5			
C8	40	3	1	C8-SL-2C81 180-40-2	80.0	40.0	180.0	20.5	81.0	81	70	17.0	6.9			

Para componentes, visite www.sandvik.coromant.com



A

Coromant Capto® para adaptador CoroTurn® SL70

POR

B

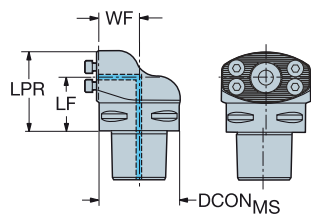

C

				Dimensões, mm							
CZC _{MS}	CZC _{MS}	CNSC	CXSC	Código para pedido	DCON _{MS}	LPR	LF	WF	BAR	NM	KG
C5	70	3	1	C5-SL70-R/LF-043	50.0	63.3	43.0	33.0	150	30.0	1.4
C6	70	3	1	C6-SL70-R/LF-043	63.0	63.2	43.0	33.0	150	30.0	1.7
C8	70	3	1	C8-SL70-R/LF-051	80.0	71.3	51.0	41.5	150	30.0	3.2
C10	70	3	1	C10-SL70-R/LF-070	100.0	90.2	70.0	51.5	150	30.0	6.2

D

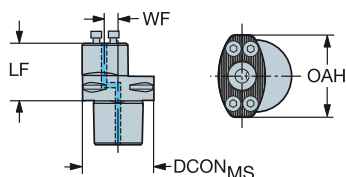

E

				Dimensões, mm								
CZC _{MS}	CZC _{MS}	CNSC	CXSC	Código para pedido	DCON _{MS}	LF	WF	OAW	OAH	BAR	NM	KG
C5	70	3	1	C5-SL70-R/LG-050	50.0	50.0	11.5	56.8	70.5	150	30.0	1.0
C6	70	3	1	C6-SL70-R/LG-050	63.0	50.0	11.5	63.0	70.5	150	30.0	1.3
C8	70	3	1	C8-SL70-R/LG-090	80.0	90.0	35.0	95.0	70.5	150	30.0	3.1
C10	70	3	1	C10-SL70-R/LG-100	100.0	100.0	48.0	118.0	70.5	150	30.0	5.2

F

Para componentes, visite www.sandvik.coromant.com

R = versão direita, L = versão esquerda

G

H



G1



H36



H5



H2

Coromant Capto® para adaptador CoroTurn® SL70

BAWS 45°

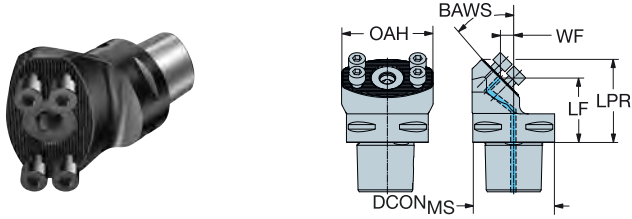

				Dimensões, mm								
CZC _{MS}	CZC _{WS}	CNSC	CXSC	Código para pedido	DCON _{MS}	LPR	LF	WF	OAH	BAR	NM	KG
C5	70	3	1	C5-SL70-R/LX-045-050M	50.0	65.0	50.0	6.0	70.5	150	30.0	0.9
C6	70	3	1	C6-SL70-R/LX-045-050M	63.0	64.0	50.0	10.0	70.5	150	30.0	1.3
				C6-SL70-RX-045-100	63.0	113.0	100.0	5.0	70.5	150	30.0	2.6
C8	70	3	1	C8-SL70-R/LX-045-090M	80.0	104.0	90.0	18.0	80.0	150	30.0	3.4

BAWS 135°

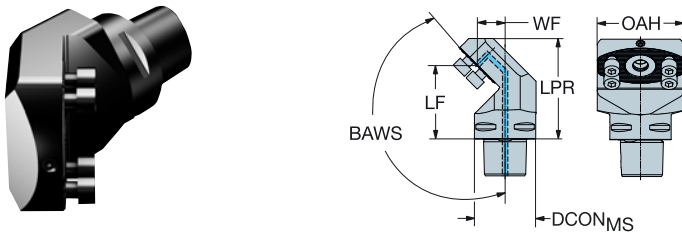

				Dimensões, mm								
CZC _{MS}	CZC _{WS}	CNSC	CXSC	Código para pedido	DCON _{MS}	LPR	LF	WF	OAH	BAR	NM	KG
C5	70	3	1	C5-SL70-R/LX-135-060	50.0	82.0	60.0	23.0	70.5	150	30.0	1.6

BAWS 5°

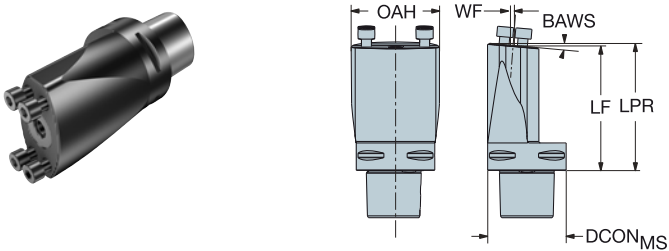

				Dimensões, mm								
CZC _{MS}	CZC _{WS}	CNSC	CXSC	Código para pedido	DCON _{MS}	LPR	LF	WF	OAW	BAR	NM	KG
C6	70	3	1	C6-SL70-R/LX-005-100	63.0	102.0	100.0	11.0	70.5	150	30.0	2.1

Para componentes, visite www.sandvik.coromant.com

R = versão direita, L = versão esquerda



G1



H36



H5



H2

A

Coromant Capto® para adaptador CoroTurn® SL70

POR

B

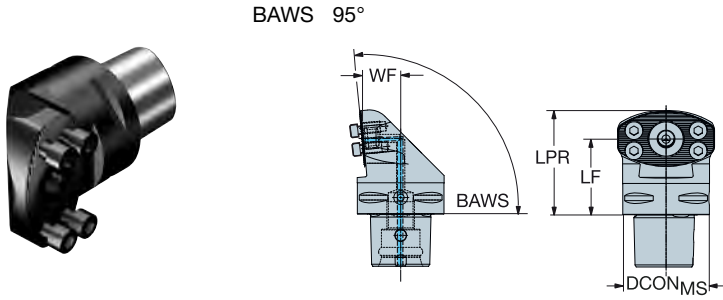

C

				Dimensões, mm								
CZC _{MS}	CZC _{WS}	CNSC	CXSC	Código para pedido	DCON _{MS}	LPR	LF	WF	OAW	BAR	NM	KG
C6	70	3	1	C6-SL70-R/LX-005-055	63.0	75.7	55.0	28.0	70.5	150	30.0	1.6

D

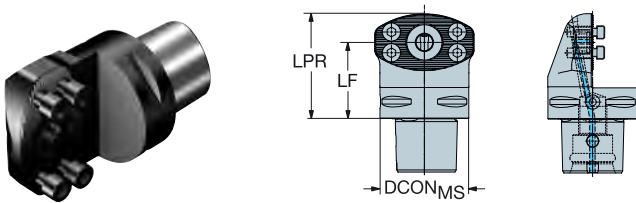

E

				Dimensões, mm							
CZC _{MS}	CZC _{WS}	CNSC	CXSC	Código para pedido	DCON _{MS}	LPR	LF	OAW	BAR	NM	KG
C6	70	3	1	C6-SL70-RF-054-00	63.0	74.3	54.0	70.5	150	30.0	1.3

Para a lista completa de componentes, acesse www.sandvik.coromant.com

R = versão direita, L = versão esquerda

F

G

H



H36



H5

Coromant Capto® para adaptador com haste retangular

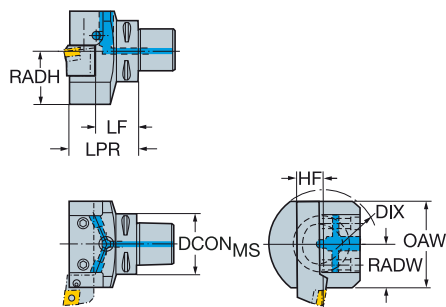

				Dimensões, mm												
CZC _{MS}	CZC _{WS}	CNSC	CXSC	Código para pedido	DCON _{MS}	LPR	LF	WF	HF	OAW	OAH	RADH	RADW	DIX	BAR	KG
C5	20 x 20	3	6	C5-ASHA-065-20HP	50.0	65.0	45.0	32.0	20.0	64.0	69.0	37.0	32.0	85	150	1.4
C6	20 x 20	3	6	C6-ASHA-070-20HP	63.0	70.0	50.0	32.0	20.0	64.0	69.0	37.0	32.0	85	150	1.8
	25 x 25	3	6	C6-ASHA-080-25HP	63.0	80.0	55.0	38.0	25.0	76.0	78.0	46.0	38.0	100	150	2.4
C8	25 x 25	3	6	C8-ASHA-075-25HP	80.0	75.0	50.0	38.0	25.0	80.0	86.0	46.0	38.0	103	150	3.0

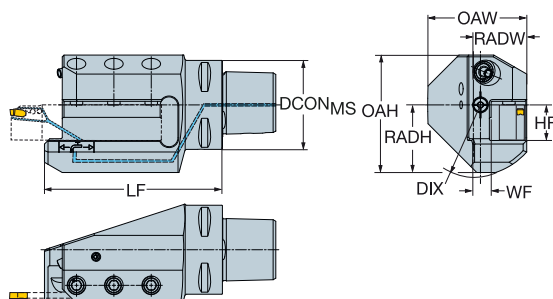

				Dimensões, mm												
CZC _{MS}	CZC _{WS}	CNSC	CXSC	Código para pedido	DCON _{MS}	LF	WF	HF	OAW	OAH	RADH	RADW	DIX	BAR	KG	
C5	20 x 20	3	5	C5-ASHR/L-095-20HP	50.0	95.0	10.0	20.0	55.5	69.0	37.0	30.0	85	150	1.6	
C6	20 x 20	3	6	C6-ASHR/L-105-20HP	63.0	105.0	10.0	20.0	63.5	69.0	37.0	30.0	85	150	2.3	
	25 x 25	3	6	C6-ASHR/L-122-25HP	63.0	122.0	13.0	25.0	70.0	78.0	46.0	38.0	100	150	3.1	
C8	25 x 25	3	5	C8-ASHR/L-122-25HP	80.0	122.0	15.0	25.0	80.0	86.0	46.0	40.0	103	150	4.3	

Para componentes, visite www.sandvik.coromant.com

N = neutra



G1



H36



H5

A

Coromant Capto® para adaptador com haste retangular

POR

B

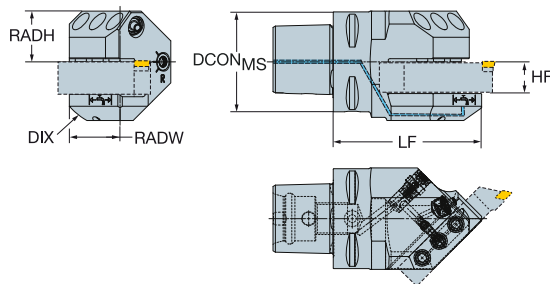

C

Dimensões, mm

CZC _{MS}	CZC _{WS}	CNSC	CXSC	Código para pedido	DCON _{MS}	LF	HF	OAW	OAH	RADH	RADW	DIX	BAR	KG
C5	20 x 20	3	6	C5-ASHR/L45-085-20HP	50.0	85.0	20.0	64.0	69.0	37.0	32.0	85	150	1.6
C6	20 x 20	3	6	C6-ASHR/L45-095-20HP	63.0	95.0	20.0	64.0	69.0	37.0	32.0	85	150	2.2
	25 x 25	3	6	C6-ASHR/L45-114-25HP	63.0	114.0	25.0	72.0	78.0	46.0	36.0	100	150	2.8

D

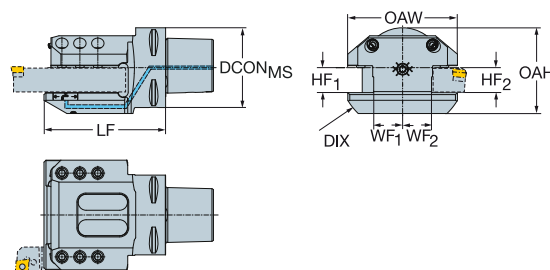

E

Dimensões, mm

CZC _{MS}	CZC _{WS}	CNSC	CXSC	Código para pedido	DCON _{MS}	LF ₁	LF ₂	WF ₁	WF ₂	HF ₁	HF ₂	OAW	OAH	RADH	RADW	DIX	BAR	KG
C6	25 x 25	3	6	C6-ASHS-122-25HP	63.0	122.0	122.0	20.0	20.0	25.0	25.0	90.0	78.0	46.0	45.0	114	150	4.1
C8	25 x 25	3	6	C8-ASHS-122-25HP	80.0	122.0	122.0	30.0	30.0	25.0	25.0	110.0	78.0	46.0	55.0	128	150	4.7

F

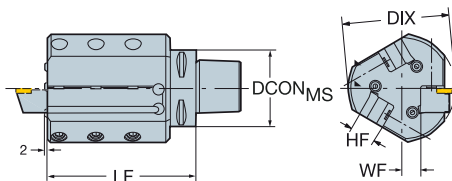

G

Dimensões, mm

CZC _{MS}	CZC _{WS}	CNSC	CXSC	Código para pedido	DCON _{MS}	LF	WF	HF	DIX	BAR	KG
C5	20 x 20	3	5	C5-ASHR3-36123-20	50.0	123.0	16.0	20.0	90	80	3.6
C6	20 x 20	3	5	C6-ASHR/L3-36125-20	63.0	125.0	16.0	20.0	90	80	3.9

Para componentes, visite www.sandvik.coromant.com

R = versão direita, L = versão esquerda

H



G1



H36



H5

Coromant Capto® para CoroChuck™ 935

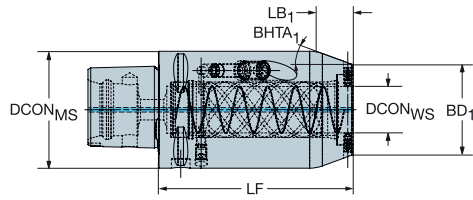

Dimensões, mm

CZC _{MS}	CZC _{WS}	CNSC	CXSC	Código para pedido	DCON _{MS}	DCON _{WS}	LSC	LF	LB ₁	BD ₁	BHTA ₁	BAR	NM	KG
C6	25	3	1	935-C6-EF25-105	63.0	25.0	100	105.0	20.0	48.4	20°	80	10.00	2.28

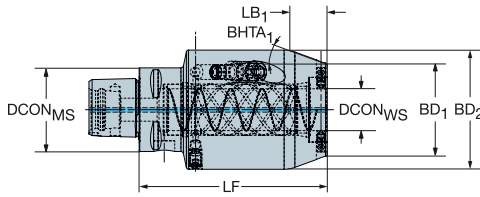

Dimensões, mm

CZC _{MS}	CZC _{WS}	CNSC	CXSC	Código para pedido	DCON _{MS}	DCON _{WS}	LSC	LF	LB ₁	BD ₁	BD ₂	BHTA ₁	BAR	NM	KG
C4	20	3	1	935-C4-EF20-090	40.0	20.0	80	90.0	18.0	43.9	57.0	20°	80	10.00	1.32
C5	20	3	1	935-C5-EF20-090	50.0	20.0	80	90.0	18.0	43.9	57.0	20°	80	10.00	1.52
	25	3	1	935-C5-EF25-110	50.0	25.0	100	110.0	20.0	48.4	63.0	20°	80	10.00	2.08

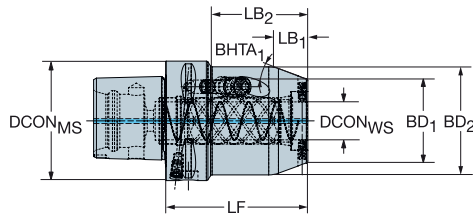

Dimensões, mm

CZC _{MS}	CZC _{WS}	CNSC	CXSC	Código para pedido	DCON _{MS}	DCON _{WS}	LSC	LF	LB ₁	LB ₂	BD ₁	BD ₂	BHTA ₁	BAR	NM	KG
C6	20	3	1	935-C6-EF20-075	63.0	20.0	80	75.0	18.0	51.0	43.9	57.0	20°	80	10.00	1.55
C8	20	3	1	935-C8-EF20-075	80.0	20.0	80	75.0	18.0	41.0	43.9	57.0	20°	80	10.00	2.41
	25	3	1	935-C8-EF25-090	80.0	25.0	100	90.0	20.0	56.0	48.4	63.0	20°	80	10.00	2.74

Para a lista completa de componentes, acesse www.sandvik.coromant.com

H36



H5

Coromant Capto® para adaptador com haste cilíndrica

Haste cilíndrica com plano conforme ISO 9766

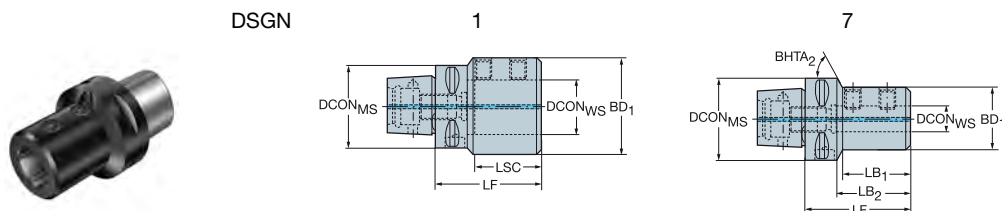

		Dimensões, mm																	
CZCMS	CZCWS	CNSC	CXSC	DSGN	Código para pedido	DCONMS	DCONWS	LSC	LF	LB1	LB2	LB3	BD1	BD2	BD3	BHTA2	BAR	NM	KG
C3	20	3	1	1	C3-391.27-20 060	32.0	20.0	51	60.0	60.0			40.0				20	12.00	0.46
	25	3	1	1	C3-391.27-25 080	32.0	25.0	57	80.0	80.0			45.0				20	20.00	0.70
C4	20	3	1	1	C4-391.27-20 060	40.0	20.0	51	60.0	60.0			40.0				20	12.00	0.55
	25	3	1	1	C4-391.27-25 077	40.0	25.0	57	77.0	77.0			45.0				20	20.00	0.75
	32	3	1	1	C4-391.27-32 088	40.0	32.0	61	88.0	88.0			52.0				20	30.00	0.99
C5	20	3	1	7	C5-391.27-20 060	50.0	20.0	51	60.0	37.7	40.0	60.0	40.0	40.0	50.0	65°	20	12.00	0.74
	25	3	1	7	C5-391.27-25 071	50.0	25.0	57	71.0	46.7	51.0	71.0	45.0	45.0	50.0	30°	20	20.00	0.46
	32	3	1	1	C5-391.27-32 075	50.0	32.0	61	75.0	75.0			52.0				20	30.00	0.97
C6	20	3	1	7	C6-391.27-20 070	63.0	20.0	51	70.0	43.8	48.0	70.0	40.0	40.0	63.0	70°	20	12.00	1.18
	25	3	1	7	C6-391.27-25 070A	63.0	25.0	57	72.0	45.8	50.0	72.0	45.0	45.0	63.0	65°	20	20.00	1.23
	32	3	1	7	C6-391.27-32 075	63.0	32.0	61	75.0	49.8	53.0	75.0	52.0	52.0	63.0	60°	20	30.00	1.30
	40	3	1	1	C6-391.27-40 085	63.0	40.0	71	85.0	85.0			65.0				20	40.00	1.74

Adaptador para buchas Easy Fix longas para Silent Tools

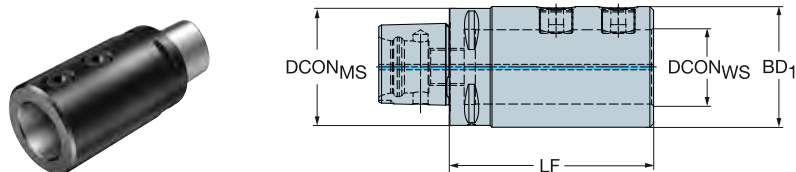

		Dimensões, mm																	
CZCMS	CZCWS	CNSC	CXSC	Código para pedido	DCONMS	DCONWS	BD1	LF	BAR	KG									
C6	40	3	1	C6-131-00110-40	63.0	40.0	80.0	110.0	80	2.1									
C8	40	3	1	C8-131-00110-40	80.0	40.0	80.0	110.0	80	2.9									

Para componentes, visite www.sandvik.coromant.com



Minitorre Coromant Capto® para duas barras de mandril

BAWS 30°

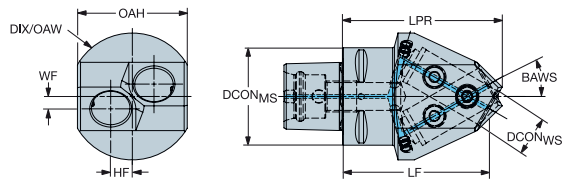

				Dimensões, mm											
CZC _{MS}	CZC _{WS}	CNSC	CXSC	Código para pedido	DCON _{MS}	DCON _{WS}	LPR	LF	WF	HF	OAW	OAH	DIX	BAR	KG
C6	25	3	1	C6-ABB-25-2	63.0	25.0	103.1	95.0	8.0	14.0	82.0	70.4	82	80	2.5

Para componentes, visite www.sandvik.coromant.com

H36



H5

Coromant Capto® para adaptador CoroTurn® XS

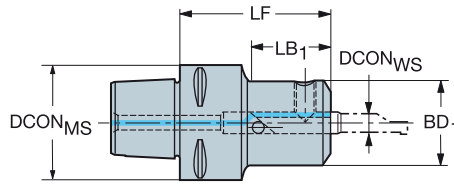
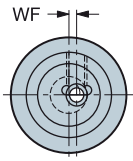

				Dimensões, mm												
CZC _{MS}	CZC _{WS}	CNSC	CXSC	Código para pedido	DCON _{MS}	DCON _{WS}	BD ₁	LB ₁	LF	WF	(BAR)	(NM)	(KG)			
C3	4	3	1	C3-CXS-42-04	32.0	4.0	21.0	22.0	42.0	1.1	10	7.0	0.2			
	5	3	1	C3-CXS-42-05	32.0	5.0	22.0	22.0	42.0	1.3	10	7.0	0.2			
	6	3	1	C3-CXS-42-06	32.0	6.0	23.5	22.0	42.0	2.0	10	7.0	0.2			
	7	3	1	C3-CXS-42-07	32.0	7.0	25.0	22.0	42.0	2.9	10	7.0	0.2			
	10	3	1	C3-CXS-42-10	32.0	10.0	21.0	27.0	42.0	0.0	10	7.0	0.2			
C4	4	3	1	C4-CXS-47-04	40.0	4.0	21.0	22.0	47.0	1.1	10	7.0	0.3			
	5	3	1	C4-CXS-47-05	40.0	5.0	22.0	22.0	47.0	1.3	10	7.0	0.3			
	6	3	1	C4-CXS-47-06	40.0	6.0	23.5	22.0	47.0	2.0	10	7.0	0.3			
	7	3	1	C4-CXS-47-07	40.0	7.0	25.0	22.0	47.0	2.9	10	7.0	0.3			
	10	3	1	C4-CXS-47-10	40.0	10.0	22.0	27.0	47.0	0.0	10	7.0	0.3			
C5	4	3	1	C5-CXS-49-04	50.0	4.0	21.0	22.0	49.0	1.1	10	7.0	0.6			
	5	3	1	C5-CXS-49-05	50.0	5.0	22.0	22.0	49.0	1.3	10	7.0	0.5			
	6	3	1	C5-CXS-49-06	50.0	6.0	23.5	22.0	49.0	2.0	10	7.0	0.5			
	7	3	1	C5-CXS-49-07	50.0	7.0	25.0	22.0	49.0	2.9	10	7.0	0.6			
C6	4	3	1	C6-CXS-95-04	63.0	4.0	21.0	22.0	95.0	1.1	10	7.0	1.4			
	5	3	1	C6-CXS-95-05	63.0	5.0	22.0	22.0	95.0	1.3	10	7.0	1.4			
	6	3	1	C6-CXS-95-06	63.0	6.0	23.5	22.0	95.0	2.0	10	7.0	1.5			
	7	3	1	C6-CXS-95-07	63.0	7.0	25.0	22.0	95.0	2.9	10	7.0	1.5			

Para componentes, visite www.sandvik.coromant.com



Coromant Capto® para adaptador de lâminas

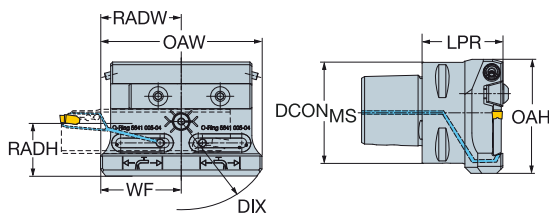

					Dimensões, mm															
CZC _{MS}	CZC _{MS}	CNSC	CXSC	Código para pedido	DCON _{MS}	LPR	LF	WF	HF	OAW	OAH	RADH	RADW	DIX	BAR	NM	KG			
C5	21	3	6	C5-APBA-040-21HP	50.0	40.0	35.0	40.0	21.0	80.0	56.5	30.0	40.0	96	70	10.0	0.8			
C6	25	3	6	C6-APBA-050-25HP	63.0	50.0	45.0	41.0	25.0	82.0	69.0	37.0	41.0	103	70	10.0	1.5			
C8	25	3	6	C8-APBA-050-25HP	80.0	50.0	45.0	41.0	25.0	82.0	80.0	37.0	41.0	103	70	10.0	2.3			

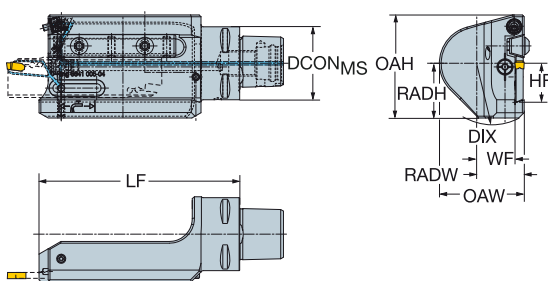

					Dimensões, mm															
CZC _{MS}	CZC _{MS}	OHN	CNSC	CXSC	Código para pedido	DCON _{MS}	LF	WF	HF	OAW	OAH	RADH	RADW	DIX	BAR	NM	KG			
C4	21L		3	6	C4-APBL-122-21HP	40.0	122.0	21.0	21.0	46.5	48.5	32.0	26.0	75	70	10	1.0			
	21R		3	6	C4-APBR-122-21HP	40.0	122.0	21.0	21.0	46.5	48.5	32.0	26.0	75	70	10	1.0			
C5	21L		3	6	C5-APBL-122-21HP	50.0	122.0	26.0	21.0	56.5	48.5	32.0	31.0	85	70	10	1.3			
	25L	150.0	3	6	C5-APBL-150-25HP	50.0	150.0	26.0	25.0	56.3	69.0	37.0	31.0	90	70	10	1.8			
	21R		3	6	C5-APBR-122-21HP	50.0	122.0	26.0	21.0	56.5	48.5	32.0	31.0	85	70	10	1.3			
	25R	150.0	3	6	C5-APBR-150-25HP	50.0	150.0	26.0	25.0	56.3	69.0	37.0	31.0	90	70	10	1.8			
C6	25L		3	6	C6-APBL-160-25HP	63.0	160.0	32.0	25.0	69.0	69.0	37.0	37.0	100	70	10	2.4			
	25R		3	6	C6-APBR-160-25HP	63.0	160.0	32.0	25.0	69.0	69.0	37.0	37.0	100	70	10	2.4			
C8	25L		3	6	C8-APBL-160-25HP	80.0	160.0	40.5	25.0	86.0	81.0	37.0	45.5	111	70	10	3.3			
	45L		3	6	C8-APBL-235-45HP	80.0	235.0	40.5	45.0	98.5	102.5	62.0	48.0	144	70	10	6.5			
	25R		3	6	C8-APBR-160-25HP	80.0	160.0	40.5	25.0	86.0	81.0	37.0	45.5	111	70	10	3.3			
	45R		3	6	C8-APBR-235-45HP	80.0	235.0	40.5	45.0	98.5	102.5	62.0	48.0	144	70	10	6.5			
C10	45L		3	6	C10-APBL-240-45HP	100.0	240.0	52.5	45.0	110.5	112.5	62.0	60.0	158	70	10	9.2			
	45R		3	6	C10-APBR-240-45HP	100.0	240.0	52.5	45.0	110.5	112.5	62.0	60.0	158	70	10	9.2			

Para componentes, visite www.sandvik.coromant.com

R = versão direita, L = versão esquerda



G1



H36



H5



Interface HSK do lado da máquina

B

C

D

E

F

G

H

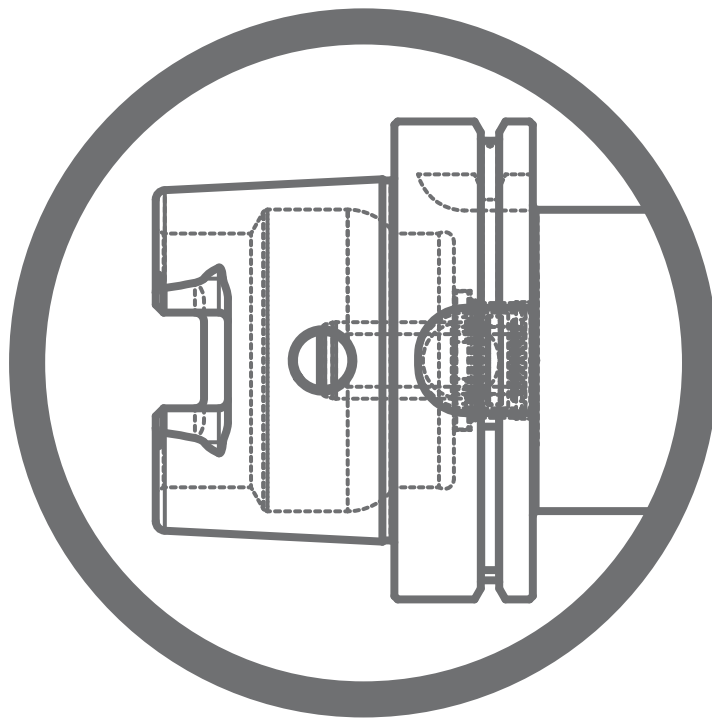

HSK para adaptador CoroTurn® SL

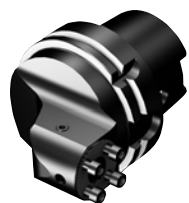

BAWS

90°

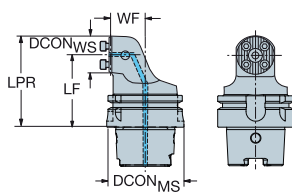

45°

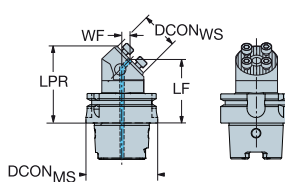

0°

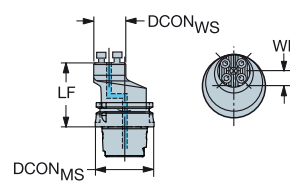

BAWS 90°

				Dimensões, mm								
CZC _{MS}	CZC _{WS}	CNSC	CXSC	Código para pedido	DCON _{MS}	DCON _{WS}	LPR	LF	WF	BAR	NM	KG
63	32	1	1	392.T63SL-32RF	63.0	32.0	76.0	60.0	31.0	70	8.8	1.1
	40	1	1	392.T63SL-40RF	63.0	40.0	85.3	65.0	31.0	70	17.0	1.4
100	40	1	1	392.T100SL-40RF	100.0	40.0	90.3	70.0	51.5	70	17.0	3.5

BAWS 45°

				Dimensões, mm								
CZC _{MS}	CZC _{WS}	CNSC	CXSC	Código para pedido	DCON _{MS}	DCON _{WS}	LPR	LF	WF	BAR	NM	KG
63	32	1	1	392.T63SL-32RX-045	63.0	32.0	66.0	55.0	5.0	70	8.8	0.9
	40	1	1	392.T63SL-40RX-045	63.0	40.0	74.0	60.0	5.0	70	17.0	1.1

BAWS 0°

				Dimensões, mm								
CZC _{MS}	CZC _{WS}	CNSC	CXSC	Código para pedido	DCON _{MS}	DCON _{WS}	LF	WF	BAR	NM	KG	
63	32	1	1	392.T63SL-32RG	63.0	32.0	67.0	15.5	150	8.8	1.0	
	40	1	1	392.T63SL-40RG	63.0	40.0	67.0	11.5	150	17.0	1.2	
100	40	1	1	392.T100SL-40RG	100.0	40.0	78.0	30.0	70	17.0	3.1	

Para componentes, visite www.sandvik.coromant.com

R = versão direita



G1



H36



H5



H2

A

HSK para adaptador CoroTurn® SL

POR

B

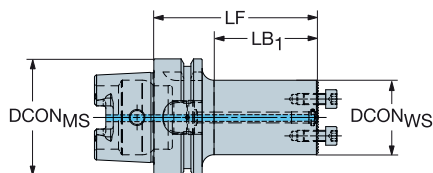

C

Dimensões, mm

CZC _{MS}	CZC _{WS}	CNSC	CXSC	Código para pedido	DCON _{MS}	DCON _{WS}	LB ₁	LF	BAR	NM	KG
63	32	1	1	HT06-32-SL32N 094	63.0	32.0	64.0	94.0	150	8.8	1.0
	40	1	1	HT06-40-SL40N 110	63.0	40.0	80.0	110.0	150	17.0	1.4

D

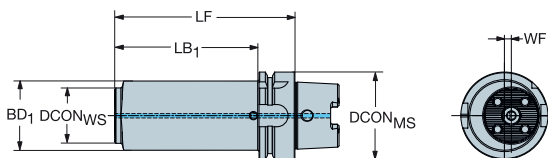

E

Dimensões, mm

CZC _{MS}	CZC _{WS}	CNSC	CXSC	Código para pedido	DCON _{MS}	DCON _{WS}	BD ₁	LB ₁	LF	WF	BAR	NM	KG
63	40	1	1	HT06-50-SL40R/L 130	63.0	40.0	50.0	100.0	130.0	5.0	150	17.0	2.2

CXSC=1 deve ser usada com cabeças de corte com refrigeração de alta precisão
 Para a lista completa de componentes, acesse www.sandvik.coromant.com

R = versão direita

F

G

H



H36



H5

HSK para adaptador CoroTurn® SL70

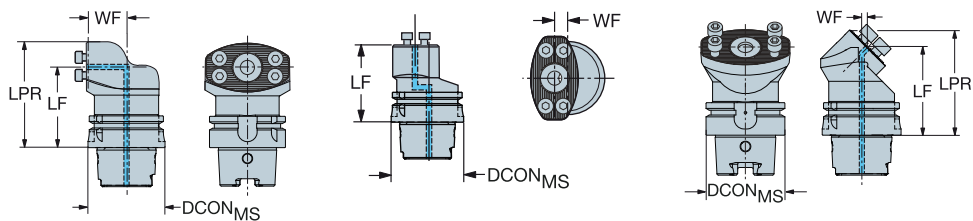

BAWS 90°

				Dimensões, mm								
CZC _{MS}	CZC _{WS}	CNSC	CXSC	Código para pedido	DCON _{MS}	LPR	LF	WF	OAW	BAR	NM	KG
63	70	1	1	392.T63SL70RF	63.0	87.3	67.0	33.0	70.0	150	30.0	1.9
100	70	1	1	392.T100SL70RF	100.0	90.3	70.0	51.5	100.0	150	30.0	4.5

BAWS 45°

				Dimensões, mm								
CZC _{MS}	CZC _{WS}	CNSC	CXSC	Código para pedido	DCON _{MS}	LPR	LF	WF	OAW	BAR	NM	KG
63	70	1	1	392.T63SL70RX-045	63.0	84.0	70.0	5.0	70.0	150	30.0	1.5
100	70	1	1	392.T100SL70RX-045	100.0	105.0	90.0	5.0	100.0	150	30.0	3.7

BAWS 0°

				Dimensões, mm								
CZC _{MS}	CZC _{WS}	CNSC	CXSC	Código para pedido	DCON _{MS}	LF	WF	BAR	NM	KG		
63	70	1	1	392.T63SL70RG	63.0	70.0	11.5	150	30.0	1.4		
100	70	1	1	392.T100-SL70RG	100.0	110.0	48.0	150	30.0	4.6		

Para componentes, visite www.sandvik.coromant.com

R = versão direita



G1



H36



H5



H2

A

HSK para adaptador com haste retangular

POR

B

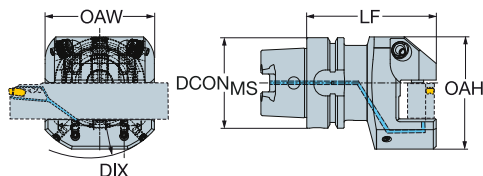

C

		Dimensões, mm														
CZC _{MS}	CZC _{WS}	CNSC	CXSC	Código para pedido	DCON _{MS}	LPR	LF	WF	HF	OAW	OAH	RADH	RADW	DIX	BAR	KG
63	25 x 25	1	6	HT06-ASHA-090-25HP	63.0	90.0	65.0	38.0	25.0	76.0	78.0	46.0	38.0	100	150	2.2
100	25 x 25	1	6	HT10-ASHA-090-25HP	100.0	90.0	65.0	38.0	25.0	99.9	99.9	46.0	38.0	103	150	4.0

D

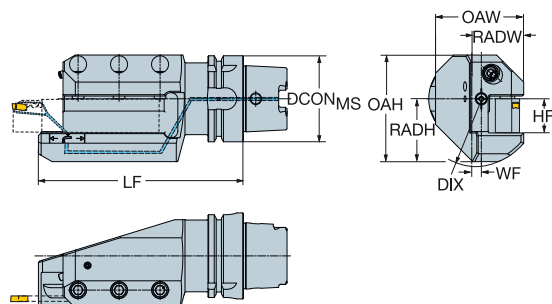

E

		Dimensões, mm														
CZC _{MS}	CZC _{WS}	CNSC	CXSC	Código para pedido	DCON _{MS}	LF	WF	HF	OAW	OAH	RADH	RADW	DIX	BAR	KG	
63	25 x 25	3	6	HT06-ASHR/L-132-25HP	63.0	132.0	13.0	25.0	69.5	78.0	46.0	38.0	100	150	3.1	
100	25 x 25	3	6	HT10-ASHR/L-132-25HP	100.0	132.0	15.0	25.0	99.9	99.9	46.0	40.0	103	150	4.7	

F

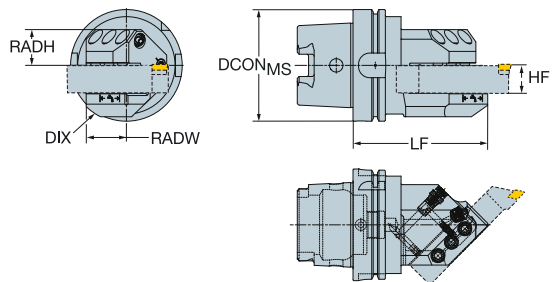

G

		Dimensões, mm														
CZC _{MS}	CZC _{WS}	CNSC	CXSC	Código para pedido	DCON _{MS}	LF	HF	OAW	OAH	RADH	RADW	DIX	BAR	KG		
100	25 x 25	3	6	HT10-ASHR/L45-122-25HP	100.0	122.0	25.0	99.9	99.9	46.0	36.0	103	150	4.3		

Para componentes, visite www.sandvik.coromant.com

R = versão direita, L = versão esquerda

H



G1



H36



H5

HSK para CoroChuck™ 935

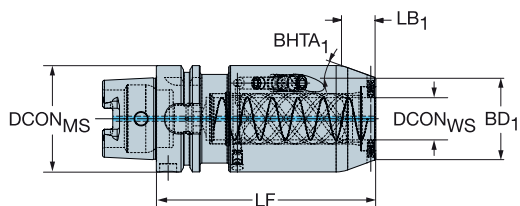

				Dimensões, mm														
CZC _{MS}	CZC _{WS}	CNSC	CXSC	Código para pedido	DCON _{MS}	DCON _{WS}	LSC	LF	LB ₁	LB ₂	LB ₃	BD ₁	BD ₂	BD ₃	BHTA ₁	BAR	NM	KG
63	20	1	1	935-HT06-EF20-110	63.0	20.0	80	110.0	18.0	84.0	110.0	43.9	57.0	63.0	20°	80	10.00	1.95
	25	1	1	935-HT06-EF25-130	63.0	25.0	100	130.0	20.0	130.0		48.4	63.0		20°	80	10.00	2.50

Para componentes, visite www.sandvik.coromant.com



H36



H5

A
B
C
D
E
F
G
H

ADAPTADORES PARA FERRAMENTAS DE TORNEAMENTO Interface HSK do lado da máquina

HSK para adaptador com haste cilíndrica

				Dimensões, mm										
CZC _{MS}	CZC _{WS}	CNSC	CXSC	Código para pedido	DCON _{MS}	DCON _{WS}	BD ₁	LF	BAR	KG				
63	25	1	7	392.T63-131-124-25	63.0	25.0	63.0	124.0	80	2.6				
	40	1	7	392.T63-131-132-40	63.0	40.0	80.0	132.0	80	3.3				

HSK para adaptador de lâminas

				Dimensões, mm															
CZC _{MS}	CZC _{WS}	CNSC	CXSC	Código para pedido	DCON _{MS}	LF	WF	HF	OAW	OAH	RADH	RADW	DIX	BAR	NM	KG			
63	25L	3	6	HT06-APBL-175-25HP	63.0	175.0	32.0	25.0	69.0	69.0	37.0	37.0	100	70	10	2.5			
	25R	3	6	HT06-APBR-175-25HP	63.0	175.0	32.0	25.0	69.0	69.0	37.0	37.0	100	70	10	2.5			

Para componentes, visite www.sandvik.coromant.com

R = versão direita, L = versão esquerda

F 30

Interface do lado da máquina Haste retangular

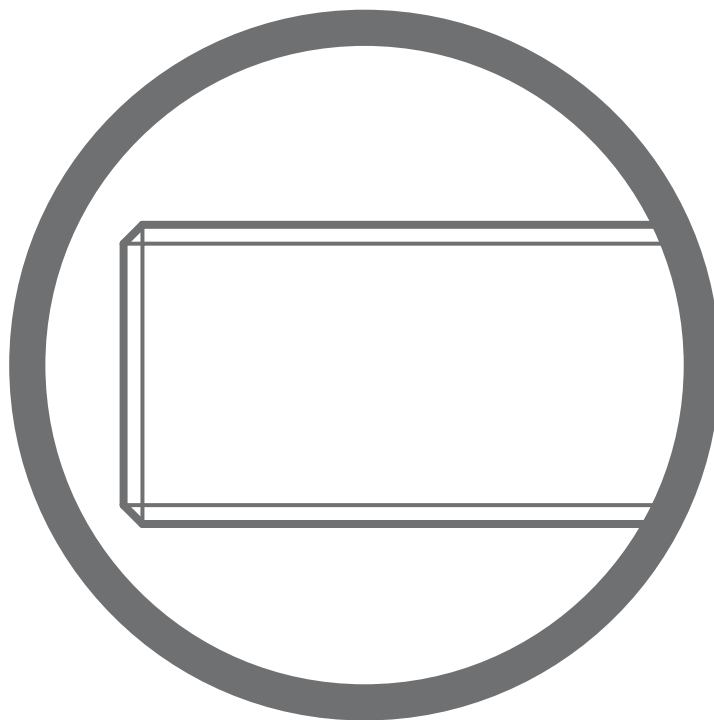

Haste retangular para adaptador CoroTurn® SL

B



570-xxR/LF

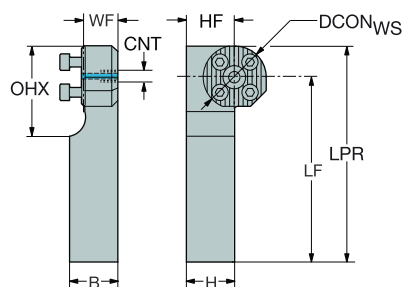

570-xxR/LF-J/N

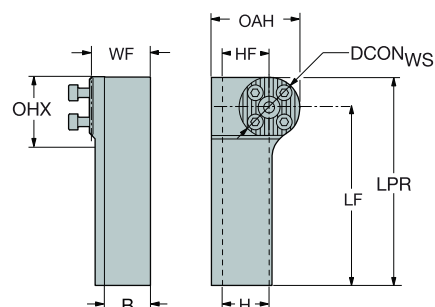

C

						Dimensões, mm													
CZC _{MS}	CZC _{WS}	OHX	CNSC	CXSC	Código para pedido	DCON _{WS}	B	H	LPR	LF	WF	HF	OAH	CNT	BAR	NM	KG		
20 x 20	32	29.0	2	1	570-32R/LF-2020	32.0	20.0	20.0	113.7	97.7	18.0	20.0		G 1/8-28	70	8.8	0.4		
25 x 25	32	32.0	2	1	570-32R/LF-2525	32.0	25.0	25.0	131.7	115.7	18.0	25.0		G 1/8-28	70	8.8	0.6		
		25.0	0	0	570-32R/LF-2525N	32.0	25.0	25.0	135.7	119.7	32.5	25.0	47.3			8.8	0.9		
32 x 32	40	30.0	0	0	570-40R/LF-2525N	40.0	25.0	25.0	131.7	111.3	32.5	25.0	51.3			17.0	0.9		
		30.0	2	1	570-32R/LF-3232	32.0	32.0	32.0	151.7	135.7	26.0	32.0		G 1/8-28	70	8.8	1.2		
	40	36.0	2	1	570-40R/LF-3232	40.0	32.0	32.0	154.0	134.0	26.0	32.0		G 1/8-28	70	17.0	1.3		

Para componentes, visite www.sandvik.coromant.com

R = versão direita, L = versão esquerda

J ou N no código = adaptador reforçado com áreas de apoio maiores. A refrigeração não é possível.

D

E

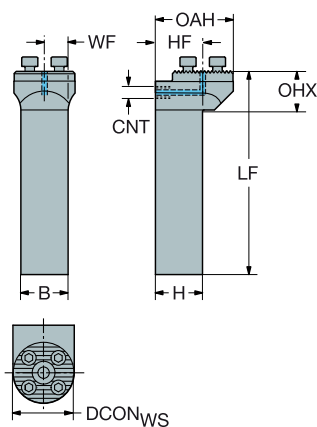
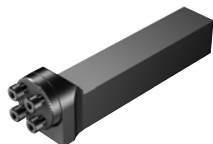

F

						Dimensões, mm													
CZC _{MS}	CZC _{WS}	OHX	CNSC	CXSC	Código para pedido	DCON _{WS}	B	H	LF	WF	HF	OAH	CNT	BAR	NM	KG			
20 x 20	25	21.0	2	1	570-25NG-2020	25.0	20.0	20.0	111.0	10.0	20.0	32.6	G 1/8-28	80	3.7	0.4			
	32	21.0	2	1	570-32NG-2020	32.0	20.0	20.0	103.0	10.0	20.0	36.2	G 1/8-28	80	8.8	0.4			
25 x 25	25	21.0	2	1	570-25NG-2525	25.0	25.0	25.0	132.0	12.5	25.0	37.6	G 1/8-28	80	3.7	0.7			
	32	21.0	2	1	570-32NG-2525	32.0	25.0	25.0	132.0	12.5	25.0	41.2	G 1/8-28	80	8.8	0.7			
	40	25.0	2	1	570-40NG-2525	40.0	25.0	25.0	132.0	12.5	25.0	45.2	G 1/8-28	80	17.0	0.0			
32 x 32	32	21.0	2	1	570-32NG-3232	32.0	32.0	32.0	152.0	16.0	32.0	48.2	G 1/8-28	80	8.8	1.2			
	40	26.0	2	1	570-40NG-3232	40.0	32.0	32.0	152.0	16.0	32.0	52.2	G 1/8-28	80	17.0	1.3			

Para componentes, visite www.sandvik.coromant.com

N = neutra

H



H36



H5



H2

Haste retangular para adaptador CoroTurn® XS

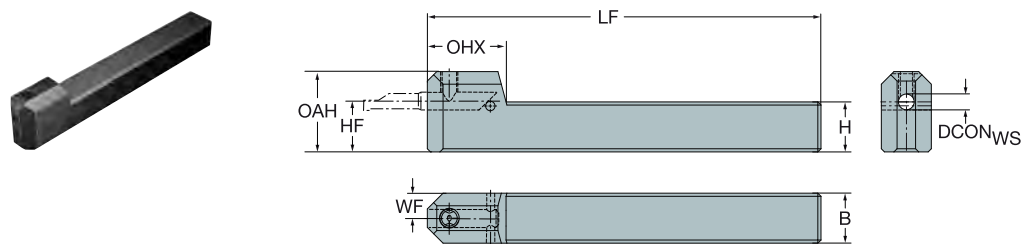

			Dimensões, mm											
CZC _{MS}	CZC _{WS}	OHX	Código para pedido	DCON _{WS}	B	H	LF	WF	HF	OAH	(NM)	(KG)		
12 x 12	4	19.0	CXS-1212-04FN	4.0	12.0	12.0	100.0	6.0	12.0	21.0	7.0	0.1		
	5	25.0	CXS-1212-05FN	5.0	12.0	12.0	100.0	6.0	12.0	21.5	7.0	0.1		
	6	26.0	CXS-1212-06FN	6.0	12.0	12.0	100.0	6.0	12.0	22.0	7.0	0.1		
16 x 16	4	19.0	CXS-1616-04FN	4.0	16.0	16.0	125.0	8.0	16.0	25.0	7.0	0.2		
	5	25.0	CXS-1616-05FN	5.0	16.0	16.0	125.0	8.0	16.0	25.5	7.0	0.2		
	6	26.0	CXS-1616-06FN	6.0	16.0	16.0	125.0	8.0	16.0	26.0	7.0	0.2		
	7	26.5	CXS-1616-07FN	7.0	16.0	16.0	125.0	8.0	16.0	26.5	7.0	0.2		
20 x 20	4	19.0	CXS-2020-04FN	4.0	20.0	20.0	125.0	10.0	20.0	29.0	7.0	0.4		
	5	25.0	CXS-2020-05FN	5.0	20.0	20.0	125.0	10.0	20.0	29.5	7.0	0.4		
	6	25.5	CXS-2020-06FN	6.0	20.0	20.0	125.0	10.0	20.0	30.0	7.0	0.4		
	7	26.5	CXS-2020-07FN	7.0	20.0	20.0	125.0	10.0	20.0	30.5	7.0	0.4		
	8	32.5	CXS-2020-08FN	8.0	20.0	20.0	125.0	10.0	20.0	31.0	7.0	0.4		
25 x 25	10	34.5	CXS-2020-10FN	10.0	20.0	20.0	125.0	10.0	20.0	32.0	7.0	0.4		
	5	25.9	CXS-2525-05FN	5.0	25.0	25.0	150.0	12.5	25.0	34.5	7.0	0.7		
	6	25.5	CXS-2525-06FN	6.0	25.0	25.0	150.0	12.5	25.0	35.0	7.0	0.7		
	7	26.5	CXS-2525-07FN	7.0	25.0	25.0	150.0	12.5	25.0	35.5	7.0	0.7		
	8	32.5	CXS-2525-08FN	8.0	25.0	25.0	150.0	12.5	25.0	36.0	7.0	0.7		
	10	34.5	CXS-2525-10FN	10.0	25.0	25.0	150.0	12.5	25.0	37.0	7.0	0.7		

Para componentes, visite www.sandvik.coromant.com

N = neutra



H36



H5



B115

Haste retangular para adaptador CoroTurn® XS

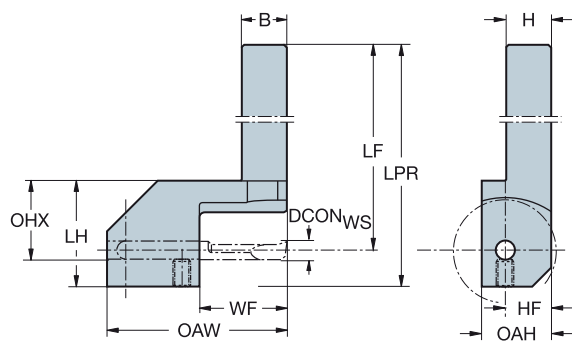

		Dimensões, mm																	
CZC _{MS}	CZC _{WS}	OHN	OHX	CNSC	CXSC	Código para pedido	DCON _{WS}	B	H	LPR	LF	WF	HF	OAW	OAH	CNT	BAR	NM	KG
10 x 10	4	29.0	29.0	1	2	CXS-1010-04R/L	4.0	10.0	10.0	99.0	89.0	18.0	10.0	36.5	16.0	M 5	10	7.0	0.1
	5	29.0	29.0	1	2	CXS-1010-05R/L	5.0	10.0	10.0	99.0	89.0	23.0	10.0	48.0	16.0	M 5	10	7.0	0.1
	6	29.0	29.0	1	2	CXS-1010-06R/L	6.0	10.0	10.0	99.0	89.0	28.0	10.0	53.0	16.0	M 5	10	7.0	0.1
12 x 12	4	29.0	29.0	1	2	CXS-1212-04R/L	4.0	12.0	12.0	99.0	89.0	18.0	12.0	36.5	18.0	M 5	10	7.0	0.1
	5	29.0	29.0	1	2	CXS-1212-05R/L	5.0	12.0	12.0	99.0	89.0	23.0	12.0	48.0	18.0	M 5	10	7.0	0.2
	6	29.0	29.0	1	2	CXS-1212-06R/L	6.0	12.0	12.0	99.0	89.0	28.0	12.0	53.0	18.0	M 5	10	7.0	0.2
16 x 16	5	29.0	34.0	1	2	CXS-1616-05R	5.0	16.0	16.0	104.0	94.0	23.0	16.0	48.0	22.0	M 5	10	7.0	0.3
	6	34.0	34.0	1	2	CXS-1616-06R/L	6.0	16.0	16.0	104.0	94.0	28.0	16.0	53.0	22.0	M 5	10	7.0	0.3

Para componentes, visite www.sandvik.coromant.com

R = versão direita, L = versão esquerda



H36

H5

B115

Haste retangular para adaptador CoroCut® MB

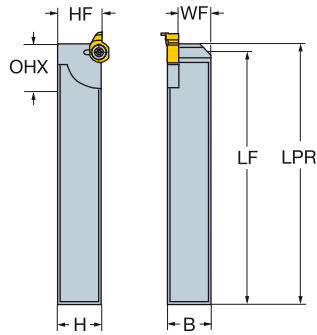

			Dimensões, mm											
CZC _{MS}	CZC _{WS}	OHX	Código para pedido	DCON _{WS}	B	H	LPR	LF	WF	HF	NM	KG		
12 x 12	09	20.0	MBG-1212-09R/L	9.0	12.0	12.0	100.0	95.5	15.1	12.0	3.0	0.1		
16 x 16	09	20.0	MBG-1616-09R/L	9.0	16.0	16.0	120.0	115.5	19.1	16.0	3.0	0.2		
20 x 20	09	20.0	MBG-2020-09R/L	9.0	20.0	20.0	120.0	115.5	23.1	20.0	3.0	0.4		
25 x 25	09	20.0	MBG-2525-09R/L	9.0	25.0	25.0	150.0	145.5	28.1	25.0	3.0	0.7		

O furo mín. geral depende da pastilha, veja a respectiva página para pedido da pastilha

Nota: As ferramentas versão direita usam pastilhas versão esquerda e vice-versa.

Para componentes, visite www.sandvik.coromant.com

R = versão direita,
L = versão esquerda



H36



H5



B122

Interface do lado da máquina Haste cilíndrica

B

C

D

E

F

G

H

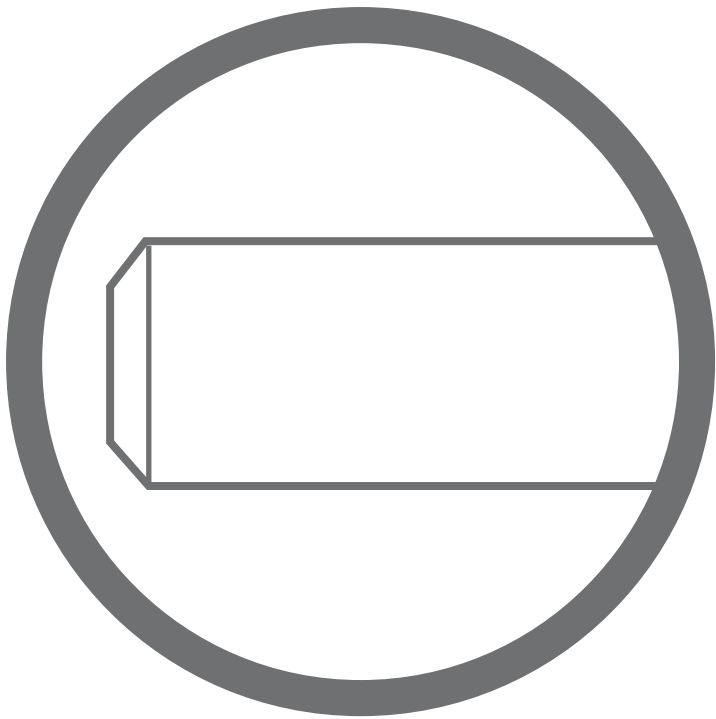

Haste cilíndrica para adaptador CoroTurn® SL

Com ranhura para bucha EasyFix

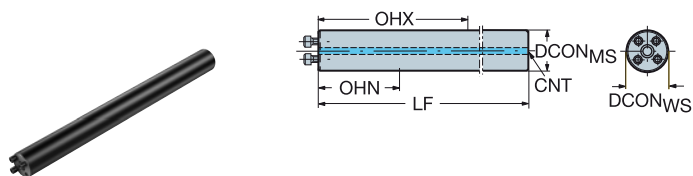

							Dimensões, mm					
CZC _{MS}	CZC _{WS}	OHN	OHX	CNSC	CXSC	Código para pedido	DCON _{MS}	DCON _{WS}	LF	BAR	NM	KG
16	16	16.0	41.0	1	1	SL-2C 16 105	16.0	16.0	105.0	150	2.0	0.1
20	20	20.0	60.0	1	1	SL-2C 20 140	20.0	20.0	140.0	150	2.8	0.3
25	25	25.0	100.0	1	1	SL-2C 25 200	25.0	25.0	200.0	150	3.7	0.7

Haste cilíndrica para adaptador CoroTurn® SL inteiriço de metal duro

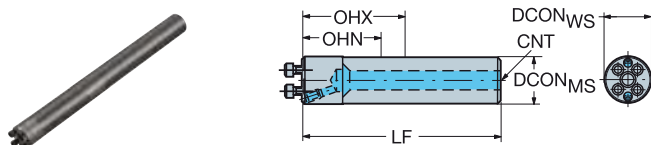

Com ranhura para bucha EasyFix

							Dimensões, mm					
CZC _{MS}	CZC _{WS}	OHN	OHX	CNSC	CXSC	Código para pedido	DCON _{MS}	DCON _{WS}	LF	BAR	NM	KG
16	16	16.0	76.0	1	3	570-2C 16 170 CR	16.0	16.0	170.0	150	2.0	0.4
20	20	20.0	100.0	1	3	570-2C 20 200 CR	20.0	20.0	200.0	150	2.8	0.8
25	25	25.0	130.0	1	3	570-2C 25 250 CR	25.0	25.0	250.0	150	3.7	1.5

Para componentes, visite www.sandvik.coromant.com



H36



H5



H2

Haste cilíndrica para adaptador CoroCut® MB

Com ranhura para bucha EasyFix

Haste de metal duro

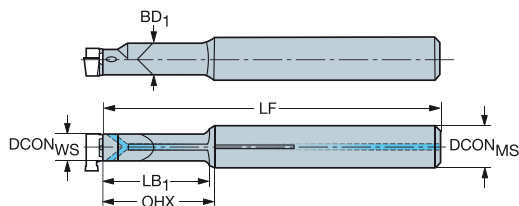

Dimensões, mm

CZC _{MS}	CZC _{WS}	OHX	CNSC	CXSC	Código para pedido	DCON _{MS}	DCON _{WS}	BD ₁	LB ₁	LF	BAR	KG
12	07	24.0	1	1	MB-E12-24-07R	12.0	7.0	7.4	20.1	88.1	10	0.1
		32.0	1	1	MB-E12-32-07R	12.0	7.0	7.4	28.1	96.1	10	0.1
		48.0	1	1	MB-E12-48-07R	12.0	7.0	7.4	44.1	111.1	10	0.1
		64.0	1	3	MB-E12-64-07R	12.0	7.0	9.0	60.1	126.1	80	0.1
	09	34.0	1	1	MB-E12-34-09R	12.0	9.0	9.5	28.7	94.7	10	0.1
		45.0	1	1	MB-E12-45-09R	12.0	9.0	9.5	39.7	104.7	10	0.1
		64.0	1	1	MB-E12-64-09R	12.0	9.0	9.5	59.7	124.7	10	0.0
16	09	34.0	1	1	MB-E16-34-09R	16.0	9.0	9.5	28.7	94.7	10	0.2
		45.0	1	1	MB-E16-45-09R	16.0	9.0	9.5	39.7	104.7	10	0.2
		64.0	1	1	MB-E16-64-09R	16.0	9.0	9.5	58.7	124.7	10	0.2
		75.0	1	3	MB-E16-75-09R	16.0	9.0	11.0	69.8	134.8	80	0.2
		42.0	1	1	MB-E16-42-11R	16.0	11.0	11.0	42.0	94.4	10	0.2
	11	60.0	1	1	MB-E16-60-11R	16.0	11.0	11.0	60.0	124.4	10	0.3
		85.0	1	1	MB-E16-85-11R	16.0	11.0	11.0	85.0	154.4	10	0.4
20	11	85.0	1	1	MB-E20-85-11R	20.0	11.0	11.0	85.0	154.4	10	0.5

O furo mín. geral depende da pastilha, veja a respectiva página para pedido da pastilha

Para componentes, visite www.sandvik.coromant.com



H36



H5



B122

Interface do lado da máquina Haste cilíndrica com plano

B

C

D

E

F

G

H

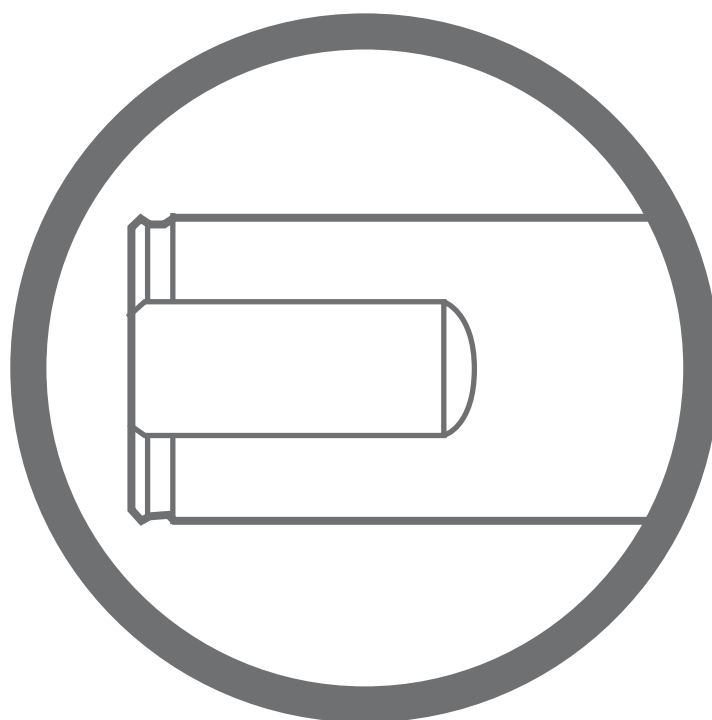

Haste cilíndrica com planos para adaptador CoroTurn® SL

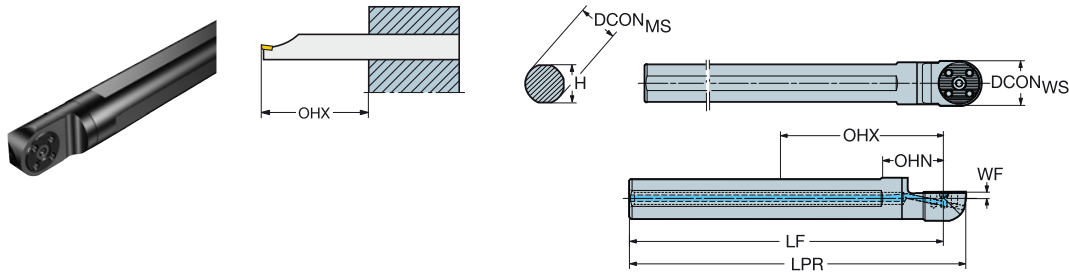

Barras de mandril para canais frontais

							Dimensões, mm										
CZC _{MS}	CZC _{WS}	OHN	OHX	CNSC	CXSC	Código para pedido	DCON _{MS}	DCON _{WS}	H	LPR	LF	WF	BAR	NM	KG		
25	32	41.0	100.0	1	1	SL-25-32NF	25.0	32.0	23.0	216.0	200.0	5.9	70	8.8	0.8		
32	32	41.0	128.0	1	1	SL-32-32NF	32.0	32.0	30.0	266.0	250.0	5.9	70	8.8	1.4		
40	32	50.0	160.0	1	1	SL-40-32NF	40.0	32.0	37.0	320.0	300.0	5.9	70	8.8	2.7		
40	40	50.0	160.0	1	1	SL-40-40NF	40.0	40.0	37.0	320.0	300.0	5.9	70	17.0	2.7		
50	32	50.0	200.0	1	1	SL-50-32NF	50.0	32.0	47.0	375.0	350.0	12.0	70	8.8	5.5		

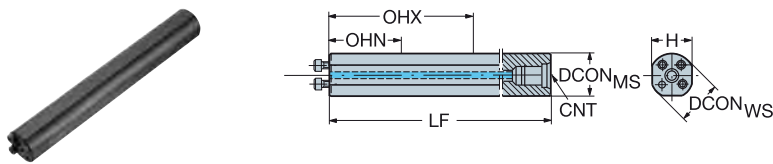

							Dimensões, mm										
CZC _{MS}	CZC _{WS}	OHN	OHX	CNSC	CXSC	Código para pedido	DCON _{MS}	DCON _{WS}	H	LF	WF	CNT	BAR	NM	KG		
16	16	0.0	44.0	1	3	570-2C 16 105	16.0	16.0	15.0	105.0	0.0	G 1/8-28	150	2.0	0.1		
20	20	0.0	60.0	1	3	570-2C 20 140	20.0	20.0	18.0	140.0	0.0	G 1/4-19	150	2.8	0.3		
25	25	0.0	80.0	1	3	570-2C 25 200	25.0	25.0	23.0	200.0	0.0	G 1/4-19	150	3.7	0.7		
32	32	0.0	96.0	1	1	570-2C 32 218	32.0	32.0	30.0	218.0	0.0	G 3/8-19	150	8.8	1.1		
40	40	0.0	128.0	1	1	570-2C 40 283	40.0	40.0	37.0	283.0	0.0	G 1/2-14	150	17.0	2.4		
50	40	0.0	168.0	1	1	570-2C 50 368-40	50.0	40.0	47.0	368.0	5.0	G 1/2-14	150	17.0	5.2		
60	40	0.0	208.0	1	1	570-2C 60 468-40	60.0	40.0	57.0	468.0	10.0	G 1/2-14	150	17.0	9.4		

Para componentes, visite www.sandvik.coromant.com



Haste cilíndrica com planos para CoroChuck™ 935

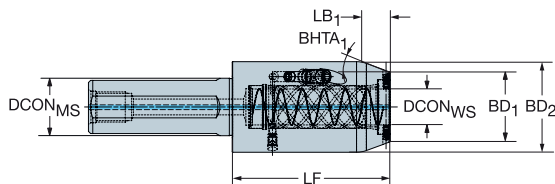

				Dimensões, mm													
CZC _{MS}	CZC _{WS}	CNSC	CXSC	Código para pedido	DCON _{MS}	DCON _{WS}	LSC	LF	LB ₁	BD ₁	BD ₂	BHTA ₁	BAR	NM	KG		
40	20	1	1	935-L40-EF20-070	40.0	20.0	100	70.0	18.0	43.9	57.0	20°	80	10.00	1.92		
	25	1	1	935-L40-EF25-110	40.0	25.0	100	110.0	20.0	48.4	63.0	20°	80	10.00	2.95		
50	20	1	1	935-L50-EF20-070	50.0	20.0	120	70.0	18.0	53.9	57.0	20°	80	10.00	2.74		
	25	1	1	935-L50-EF25-090	50.0	25.0	120	90.0	20.0	48.4	63.0	20°	80	10.00	3.32		

Para a lista completa de componentes, acesse www.sandvik.coromant.com



H36



H5

Adaptador CoroTurn® XS de haste cilíndrica com planos

Cilíndrica com dois planos

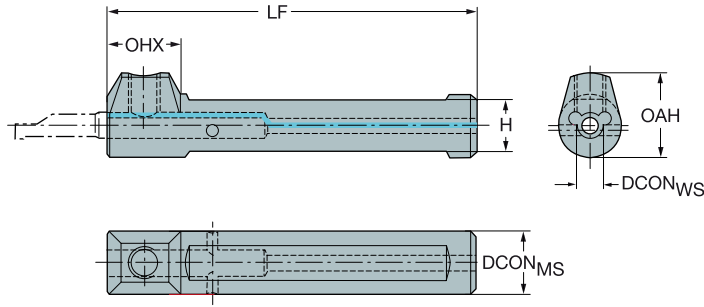

Haste de aço

							Dimensões, mm									
CZC _{MS}	CZC _{WS}	OHX	CNSC	CXSC	DSGN	Código para pedido	DCON _{MS}	DCON _{WS}	H	LF	OAH	BAR	NM	KG		
10	4	14.0	1	1	1	CXS-A10-04	10.0	4.0	8.0	65.0	14.5	10	7.0	0.0		
	5	14.0	1	1	1	CXS-A10-05	10.0	5.0	8.0	65.0	15.0	10	7.0	0.0		
12	4	14.0	1	1	1	CXS-A12-04	12.0	4.0	10.0	70.0	15.5	10	7.0	0.0		
	5	14.0	1	1	1	CXS-A12-05	12.0	5.0	10.0	70.0	16.0	10	7.0	0.0		
16	6	14.0	1	1	1	CXS-A12-06	12.0	6.0	10.0	70.0	16.5	10	7.0	0.0		
	4	14.0	1	1	1	CXS-A16-04	16.0	4.0	14.0	75.0	17.5	10	7.0	0.1		
	5	14.0	1	1	1	CXS-A16-05	16.0	5.0	14.0	75.0	18.0	10	7.0	0.1		
	6	14.0	1	1	1	CXS-A16-06	16.0	6.0	14.0	75.0	18.5	10	7.0	0.1		
	7	14.0	1	1	1	CXS-A16-07	16.0	7.0	14.0	75.0	19.0	10	7.0	0.1		
	8	14.0	1	1	1	CXS-A16-08	16.0	8.0	14.0	75.0	19.5	10	7.0	0.0		
20	4	14.0	1	1	1	CXS-A20-04	20.0	4.0	18.0	90.0	20.0	10	7.0	0.2		
	5	14.0	1	1	1	CXS-A20-05	20.0	5.0	18.0	90.0	20.0	10	7.0	0.2		
	6	14.0	1	1	1	CXS-A20-06	20.0	6.0	18.0	90.0	22.0	10	7.0	0.2		
	7	14.0	1	1	1	CXS-A20-07	20.0	7.0	18.0	90.0	22.0	10	7.0	0.2		
	8	14.0	1	1	1	CXS-A20-08	20.0	8.0	18.0	90.0	25.0	10	7.0	0.0		
25	10	14.0	1	1	1	CXS-A20-10	20.0	10.0	18.0	90.0	25.0	10	7.0	0.2		
	8	14.0	1	1	1	CXS-A25-08	25.0	8.0	23.0	110.0	25.0	10	7.0	0.4		
	10	14.0	1	1	1	CXS-A25-10	25.0	10.0	23.0	110.0	25.0	10	7.0	0.4		

Para componentes, visite www.sandvik.coromant.com



Adaptador CoroTurn® XS de haste cilíndrica com planos

Cilíndrica com dois planos

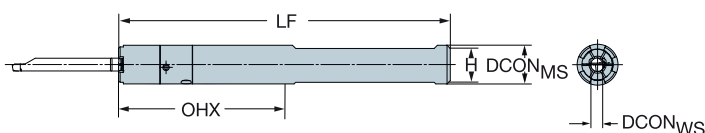

Haste de aço

							Dimensões, mm										
CZC _{MS}	CZC _{WS}	OHX	CNSC	CXSC	DSGN	Código para pedido	DCON _{MS}	DCON _{WS}	H	BD ₁	LB ₁	LF	BAR	NM	KG		
12 (x 10)	4	22.0	1	3	2	CXS-A12-04-X	12.0	4.0	11.0	14.5	70.0	70.0	80	20.0	0.0		
	5	23.0	1	3	2	CXS-A12-05-X	12.0	5.0	11.0	14.5	70.0	70.0	80	20.0	0.0		
16 (x 14)	4	22.0	1	3	2	CXS-A16-04-X	16.0	4.0	15.0	14.5	13.0	75.0	80	20.0	0.1		
	5	23.0	1	3	2	CXS-A16-05-X	16.0	5.0	15.0	14.5	14.0	75.0	80	20.0	0.1		
	6	26.5	1	3	2	CXS-A16-06-X	16.0	6.0	15.0	16.5	75.0	75.0	80	20.0	0.1		
	7	26.5	1	3	2	CXS-A16-07-X	16.0	7.0	15.0	16.5	75.0	75.0	80	20.0	0.1		
25	4	24.0	1	3	2	CXS-A25-04-X	25.0	4.0	24.0	14.5	13.0	110.0	80	20.0	0.3		
	5	25.0	1	3	2	CXS-A25-05-X	25.0	5.0	24.0	14.5	14.0	110.0	80	20.0	0.3		
	6	26.5	1	3	2	CXS-A25-06-X	25.0	6.0	24.0	16.5	17.5	110.0	80	20.0	0.3		
	7	26.0	1	3	2	CXS-A25-07-X	25.0	7.0	24.0	16.5	17.5	110.0	80	20.0	0.3		

Haste de metal duro

							Dimensões, mm						
CZC _{MS}	CZC _{WS}	OHX	CNSC	CXSC		Código para pedido	DCON _{MS}	DCON _{WS}	H	LF	BAR	NM	KG
12 (x 10)	4	53.0	1	3		CXS-E12-04-X	12.0	4.0	11.0	103.0	80	8.0	0.1
	5	58.0	1	3		CXS-E12-05-X	12.0	5.0	24.0	108.0	80	8.0	0.2

Para componentes, visite www.sandvik.coromant.com



H36



H5



B115

A
B
C
D
E
F
G
H

Haste cilíndrica com planos para adaptador CoroTurn® XS com dupla extremidade

FOR

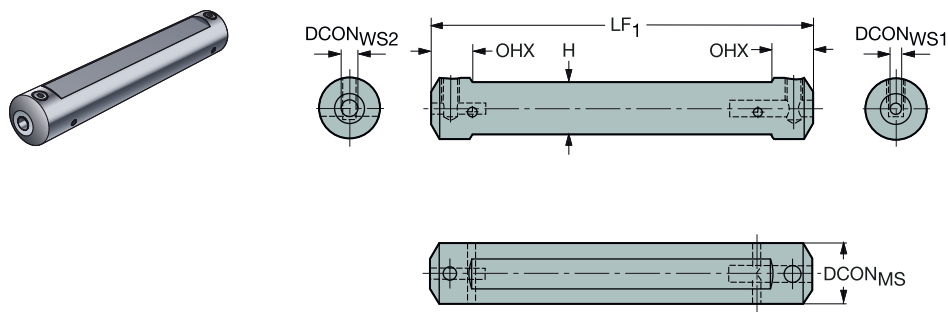

					Dimensões, mm							
CZC _{MS}	CZC _{WS}	OHN	CNSC	CXSC	Código para pedido	DCON _{MS}	DCON _{WS}	H	LF	BAR	NM	KG
20	6	15.0	1	1	CXS-A20-04-06	20.0	6.0	18.0	140.0	10	7	0.3

Para componentes, visite www.sandvik.coromant.com



Haste cilíndrica com planos para adaptador CoroCut® MB

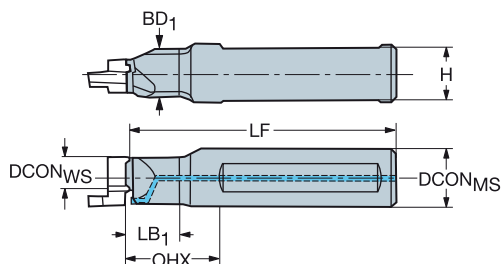

Haste de aço

					Dimensões, mm									
CZC _{MS}	CZC _{WS}	OHX	CNSC	CXSC	Código para pedido	DCON _{MS}	DCON _{WS}	H	BD ₁	LB ₁	LF	(BAR)	(KG)	
16	09	15.7	1	1	MB-A16-05-09R/L-HP	16.0	9.0	14.0	16.0	5.3	64.7	80	0.1	
		20.0	1	1	MB-A16-20-09R/L-HP	16.0	9.0	14.0	9.0	20.0	74.7	80	0.1	
20	11	5.6	1	1	MB-A20-05-11R/L-HP	20.0	11.0	18.0	11.0	5.6	79.4	80	0.2	

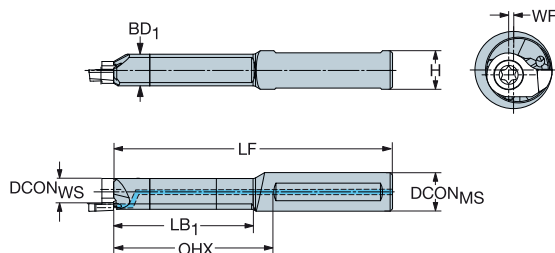

Haste de metal duro

					Dimensões, mm									
CZC _{MS}	CZC _{WS}	OHX	CNSC	CXSC	Código para pedido	DCON _{MS}	DCON _{WS}	H	BD ₁	LB ₁	LF	WF	(BAR)	(KG)
12	07	27.0	1	3	MB-E12-24-07	12.0	7.0	10.0	7.4	20.1	87.9	0.0	10	0.0
		35.0	1	3	MB-E12-32-07	12.0	7.0	10.0	7.4	28.1	96.1	0.0	10	0.1
		50.0	1	3	MB-E12-48-07	12.0	7.0	10.0	7.4	44.1	111.1	0.0	10	0.2
09	09	34.0	1	3	MB-E12-34-09	12.0	9.0	10.0	9.5	28.7	94.7	0.0	10	0.1
		45.0	1	3	MB-E12-45-09	12.0	9.0	10.0	9.5	39.7	104.7	0.0	10	0.1
		64.0	1	3	MB-E12-64-09	12.0	9.0	10.0	9.5	59.7	124.7	0.0	10	0.1
16	09	45.0	1	3	MB-E16-45-09	16.0	9.0	14.0	9.5	39.7	104.7	0.0	10	0.2
		64.0	1	3	MB-E16-64-09	16.0	9.0	14.0	9.5	58.7	124.7	0.0	10	0.2
		42.0	1	3	MB-E16R/L-42-09	16.0	9.0	15.0	13.0	36.7	94.8	1.0	80	0.2
		60.0	1	3	MB-E16R/L-60-09	16.0	9.0	15.0	13.0	56.7	114.8	1.0	80	0.1

O furo mín. geral depende da pastilha, veja a respectiva página para pedido da pastilha
Para componentes, visite www.sandvik.coromant.com

R = versão direita, L = versão esquerda



H36



H5



B122

Interface do lado da máquina com parafuso e CoroTurn® SL

B

C

D

E

F

G

H

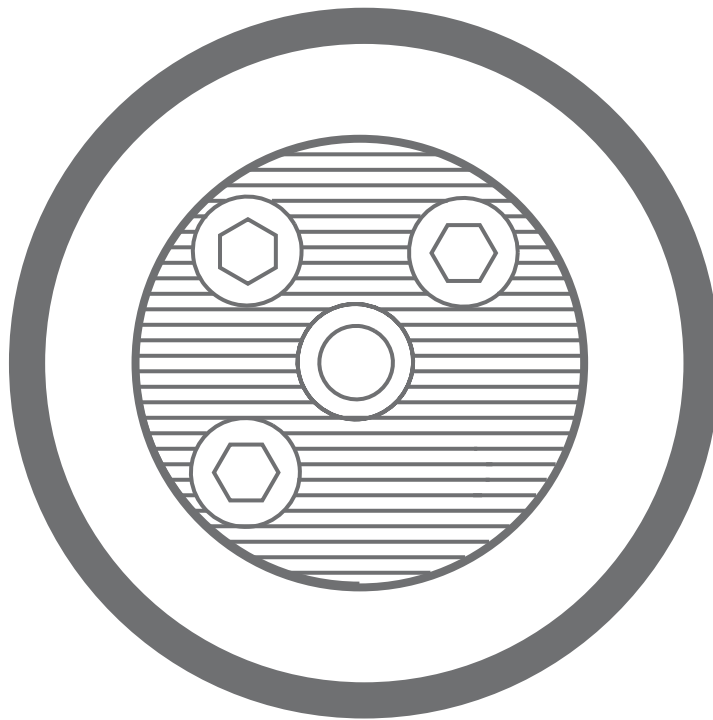

Coromant Capto® para adaptador Coromant Capto® com troca rápida

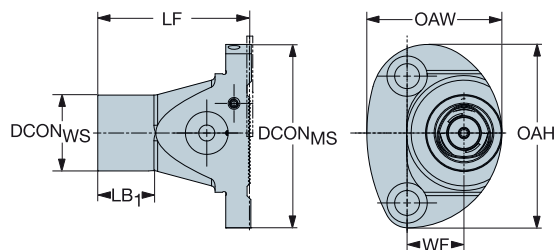

				Dimensões, mm											
CZC _{MS}	CZC _{WS}	CNSC	CXSC	Código para pedido	DCON _{MS}	DCON _{WS}	H	LB ₁	LF	WF	OAW	OAH	BAR	NM	KG
80	C3	1	1	C3-QC-SL80-R	80.0	32.0	37.5	24.5	64.0	24.0	57.0	77.4	150	35.0	0.5
100	C3	1	1	C3-QC-SL100-R	100.0	32.0	37.5	24.5	64.0	34.0	80.0	76.5	150	35.0	0.7

Para a lista completa de componentes, acesse www.sandvik.coromant.com

R = versão direita



H36



H5

A

Adaptador de redução CoroTurn® SL

B

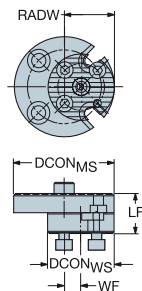
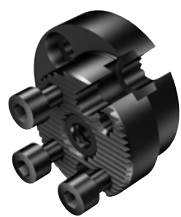

C

Dimensões, mm

CZC _{MS}	CZC _{WS}	CNSC	CXSC	Código para pedido	DCON _{MS}	DCON _{WS}	BD ₁	LB ₁	LF	WF	OAW	RADW	NM	KG
40	32	1	1	570-40 22-32	40.0	32.0	50.0	22.0	22.0	8.0	44.0	24.0	8.8	0.2
50	32	1	1	570-50 23-32	50.0	32.0	50.0	11.4	23.0	9.0	50.0	25.0	8.8	0.2
	40	1	1	570-50 23-40	50.0	40.0	50.0	11.4	23.0	10.0	55.0	30.0	17.0	0.2
60	40	1	1	570-60 23-40	60.0	40.0	60.0	11.4	23.0	10.0	60.0	30.0	17.0	0.4

D

Minitorre para quatro cabeças CoroTurn® SL

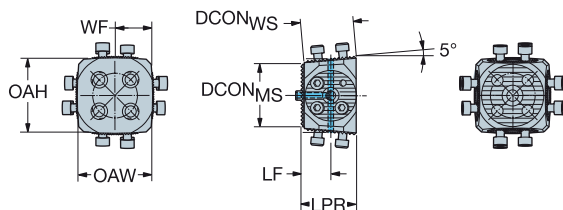

E

Dimensões, mm

CZC _{MS}	CZC _{WS}	CNSC	CXSC	Código para pedido	DCON _{MS}	DCON _{WS}	LPR	LF	WF	OAW	OAH	BAR	NM	KG
40	32	1	1	570-4-32-40-050-RA	40.0	32.0	34.5	18.0	23.0	49.3	49.3	20	8.8	0.4

Para componentes, visite www.sandvik.coromant.com

F

G

H



H36



H5



H2

CoroTurn® SL troca rápida para adaptador CoroTurn® SL

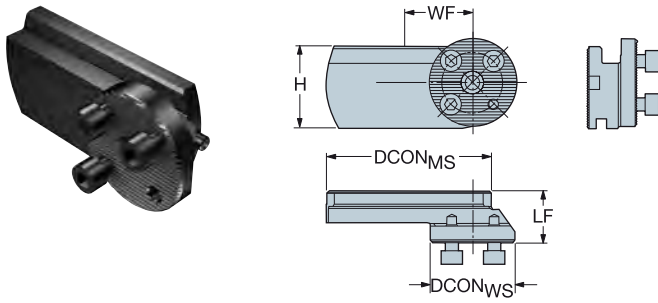

		Dimensões, mm									
CZC _{MS}	CZC _{WS}	Código para pedido	DCON _{MS}	DCON _{WS}	H	LF	WF	HF	NM	KG	
80	40	570-80 23-40R/L	80.0	40.0	37.5	23.0	70.0	20.0	17.0	0.3	

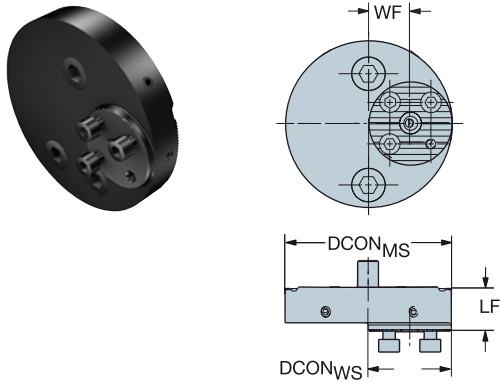

		Dimensões, mm										
CZC _{MS}	CZC _{WS}	CNSC	CXSC	Código para pedido	DCON _{MS}	DCON _{WS}	H	LF	WF	BAR	NM	KG
80	40	1	1	570-80 20 20-40R	80.0	40.0	37.5	20.0	20.0	80	17.0	0.8
100	40	1	1	570-100 20 30-40R	100.0	40.0	37.5	20.0	30.0	80	17.0	1.1

Para componentes, visite www.sandvik.coromant.com

R = versão direita, L = versão esquerda



H36



H5



H2

A

CoroTurn® SL para adaptador CoroTurn® SL troca rápida

B

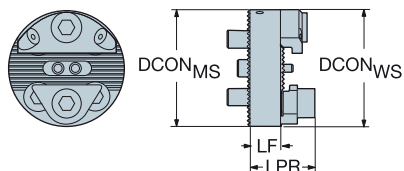

C

				Dimensões, mm						
CZC _{MS}	CZC _{WS}	CNSC	CXSC	Código para pedido	DCON _{MS}	DCON _{WS}	LPR	LF	BAR	KG
32	32	1	2	SL-32 11-32-QC	32.0	32.0	19.5	11.0	70	0.1
40	32	1	2	SL-40 12-32-QC	40.0	32.0	21.8	12.0	70	0.1

570-80 para adaptador CoroTurn® SL troca rápida

D

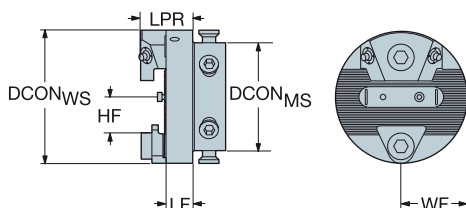

Conversão do acoplamento 580 para o CoroTurn® SL troca rápida

E

				Dimensões, mm							
CZC _{MS}	CZC _{WS}	CNSC	CXSC	Código para pedido	DCON _{MS}	DCON _{WS}	LPR	LF	BAR	NM	KG
80	80	1	2	570-80 17-580-80	65.0	80.0	32.5	17.0	80	50.0	1.1

Parafuso para adaptador CoroTurn® SL

F

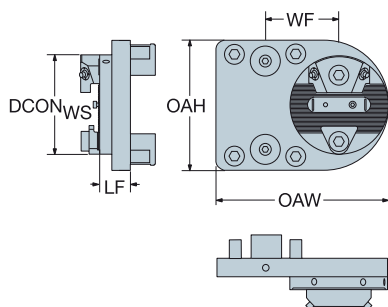
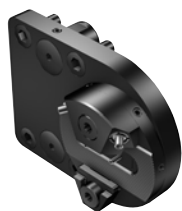

G

O adaptador é compatível com todas as barras de mandril a partir de 200 mm de diâmetro

				Dimensões, mm										
CZC _{MS}	CZC _{WS}	CNSC	CXSC	Código para pedido	DCON _{WS}	B	H	LF	WF	OAW	OAH	BAR	NM	KG
122 x 105	80	1	1	570-80 200R	80.0	122.0	105.0	25.0	59.5	139.0	104.0	80	50.0	2.3

Para componentes, visite www.sandvik.coromant.com

H



H36



H5



H2

CoroTurn® SL troca rápida para adaptador CoroTurn® SL70

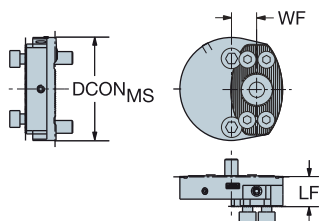

				Dimensões, mm							
CZC _{MS}	CZC _{MS}	CNSC	CXSC	Código para pedido	DCON _{MS}	H	LF	WF	<input type="radio"/> BAR	<input type="radio"/> NM	<input type="radio"/> KG
80	70	1	1	SL70-80 23-RG	80.0	37.5	23.0	20.0	<input type="radio"/>	<input type="radio"/>	<input type="radio"/>

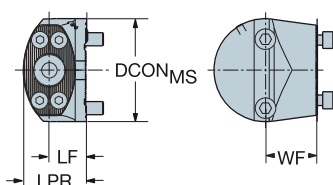

				Dimensões, mm								
CZC _{MS}	CZC _{MS}	CNSC	CXSC	Código para pedido	DCON _{MS}	H	LPR	LF	WF	<input type="radio"/> BAR	<input type="radio"/> NM	<input type="radio"/> KG
80	70	1	1	SL70-80 40-RF	80.0	37.5	48.0	28.0	40.0	<input type="radio"/>	<input type="radio"/>	<input type="radio"/>

Para componentes, visite www.sandvik.coromant.com



H36



H5



H2

A

CoroTurn® SL para adaptador de haste retangular

B

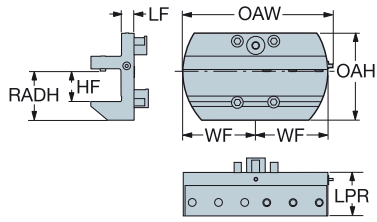

C

		Dimensões, mm											(BAR)	(KG)	
CZC _{MS}	CZC _{WS}	CNSC	CXSC	Código para pedido	B	H	LPR	LF	WF	HF	OAW	OAH	RADH		
122 x 105	32 x 32	1	2	570-200 3232-M	122.0	105.0	55.0	23.0	97.4	32.0	205.0	115.0	60.0	80	8.6

D

CoroTurn® SL troca rápida para adaptador de haste retangular

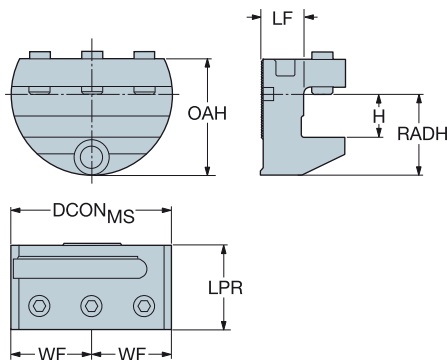

E

		Dimensões, mm										(KG)
CZC _{MS}	CZC _{WS}	Código para pedido	DCON _{MS}	H	LPR	LF	WF	HF	OAW	OAH		
80	20 x 20	570-80 20 2020R	80.0	37.5	40.0	20.0	38.5	20.0	77.0	56.0	0.7	

Para componentes, visite www.sandvik.coromant.com

G

H



H36



H5



H2

Silent Tools®

Adaptadores com mecanismo antivibratório

Aplicação

- Torneamento, rosqueamento e usinagem de canais
- Em operações com longos balanços (3–14xD ou tendência à vibração)

Minimiza vibrações com longos balanços (acima de 3xD)

Os adaptadores Silent Tools minimizam a vibração por meio de um amortecedor dentro da ferramenta que mantém boa produtividade e tolerâncias estreitas mesmo com longos balanços



● ● ● ● SilentTools®

Torneamento

Barras de mandril antivibratórias e adaptadores Silent Tools também possibilitam manter a boa produtividade e as tolerâncias estreitas para ferramentas com longos balanços, acima de 3 x o diâmetro da barra. As barras antivibratórias Silent Tools possibilitam usinar até 10 x o diâmetro da barra e nossas barras reforçadas com metal duro antivibratórias vão ainda mais além; até 14 x o balanço da ferramenta do diâmetro da barra.

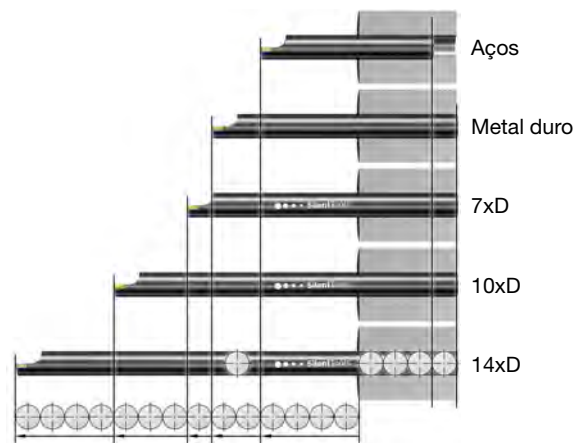

Podem ser combinadas com cabeças de corte CoroTurn SL para solução personalizada de torneamento, rosqueamento e usinagem de canais



O sistema antivibratório consiste em uma massa pesada, apoiada por elementos de mola de borracha



E5

Coromant Capto® para adaptador antivibratório CoroTurn® SL

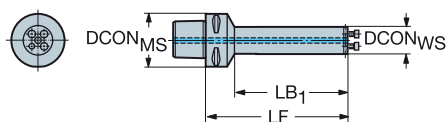

●●●● SilentTools®

				Dimensões, mm								
CZC _{MS}	CZC _{WS}	CNSC	CXSC	Código para pedido	DCON _{MS}	DCON _{WS}	LB ₁	LF	BAR	NM	KG	
C3	16	3	3	C3-570-3C 16 082	32.0	16.0	63.4	82.0	70	2.0	0.2	
	20	3	3	C3-570-3C 20 101	32.0	20.0	82.9	101.0	70	2.8	0.3	
	25	3	3	C3-570-3C 25 125	32.0	25.0	107.6	125.0	70	3.7	0.6	
		3	3	C3-570-3C 25 180	32.0	25.0	161.8	180.0	70	3.7	0.8	
	32	3	1	C3-SL-3C 25 125	32.0	25.0	106.8	125.0	70	3.7	0.6	
		3	1	C3-SL-3C 25 180	32.0	25.0	161.8	180.0	70	3.7	0.8	
C4	16	3	3	C4-570-3C 16 088	40.0	16.0	63.3	88.0	70	2.0	0.4	
	20	3	3	C4-570-3C 20 107	40.0	20.0	82.8	107.0	70	2.8	0.5	
	25	3	3	C4-570-3C 25 132	40.0	25.0	108.5	132.0	70	3.7	0.8	
3		3	C4-570-3C 25 180	40.0	25.0	155.7	180.0	70	3.7	0.9		
D	32	3	1	C4-SL-3C 25 132	40.0	25.0	107.7	132.0	70	3.7	0.8	
		3	1	C4-SL-3C 25 180	40.0	25.0	155.7	180.0	70	3.7	1.0	
	3	1	C4-570-3C 32 154	40.0	32.0	131.4	154.0	70	8.8	0.0		
	3	1	C4-570-3C 32 224	40.0	32.0	200.6	224.0	70	8.8	2.0		
40	3	1	C4-570-3C 40 173	40.0	40.0	173.0	173.0	70	17.0	1.7		
	3	1	C4-570-3C 40 288	40.0	40.0	288.0	288.0	70	17.0	3.4		
C5	16	3	3	C5-570-3C 16 085	50.0	16.0	58.5	85.0	70	2.0	0.5	
	20	3	3	C5-570-3C 20 109	50.0	20.0	83.5	109.0	70	2.8	0.7	
	25	3	3	C5-570-3C 25 133	50.0	25.0	107.7	133.0	70	3.7	1.0	
		3	3	C5-570-3C 25 180	50.0	25.0	154.3	180.0	70	3.7	1.2	
	32	3	3	C5-570-3C 25 230	50.0	25.0	201.0	230.0	70	3.7	1.4	
		3	1	C5-SL-3C 25 133	50.0	25.0	106.6	133.0	70	3.7	1.0	
	32	3	1	C5-SL-3C 25 180	50.0	25.0	154.3	180.0	70	3.7	1.2	
		3	1	C5-SL-3C 25 230	50.0	25.0	200.5	230.0	70	3.7	1.4	
	40	3	1	C5-570-3C 32 154	50.0	32.0	129.6	154.0	70	8.8	1.4	
		3	1	C5-570-3C 32 224	50.0	32.0	199.3	224.0	70	8.8	1.8	
3		1	C5-570-3C 32 288	50.0	32.0	261.0	288.0	70	8.8	2.4		
3		1	C5-570-3C 40 194	50.0	40.0	170.7	194.0	70	17.0	2.2		
E	32	3	1	C5-570-3C 40 288	50.0	40.0	263.4	288.0	70	17.0	3.6	
		3	1	C5-570-3C 40 368	50.0	40.0	344.5	368.0	70	17.0	4.2	
	40	3	1	C5-570-3C 40 368	50.0	40.0	344.5	368.0	70	17.0	4.2	
F	C6	16	3	3	C6-570-3C 16 088	63.0	16.0	58.5	88.0	70	2.0	1.0
		20	3	3	C6-570-3C 20 108	63.0	20.0	78.5	108.0	70	2.8	1.0
	25	3	3	C6-570-3C 25 132	63.0	25.0	103.0	132.0	70	3.7	1.5	
		3	3	C6-570-3C 25 180	63.0	25.0	146.8	180.0	70	3.7	1.6	
	32	3	3	C6-570-3C 25 230	63.0	25.0	197.0	230.0	70	3.7	1.7	
		3	1	C6-SL-3C 25 132	63.0	25.0	101.9	132.0	70	3.7	1.3	
		3	1	C6-SL-3C 25 180	63.0	25.0	146.8	180.0	70	3.7	1.5	
		3	1	C6-SL-3C 25 230	63.0	25.0	196.8	230.0	70	3.7	1.8	
	40	3	1	C6-570-3C 32 159	63.0	32.0	129.8	159.0	70	8.8	1.8	
		3	1	C6-570-3C 32 224	63.0	32.0	191.7	224.0	70	8.8	2.2	
		3	1	C6-570-3C 32 288	63.0	32.0	257.8	288.0	70	8.8	2.7	
		3	1	C6-570-3C 40 198	63.0	40.0	169.4	198.0	70	17.0	2.6	
G	C8	25	3	3	C8-570-3C 40 288	63.0	40.0	257.1	288.0	70	17.0	3.9
		3	1	C8-570-3C 40 368	63.0	40.0	338.9	368.0	70	17.0	4.2	
	32	3	3	C8-570-3C 25 147	80.0	25.0	107.6	147.0	70	3.7	2.3	
		3	1	C8-SL-3C 25 147	80.0	25.0	106.6	147.0	70	3.7	2.5	
40	3	1	C8-570-3C 32 172	80.0	32.0	133.6	172.0	70	8.8	2.8		
	3	1	C8-570-3C 32 224	80.0	32.0	184.5	224.0	70	8.8	3.6		
H	H2	3	1	C8-570-3C 40 224	80.0	40.0	186.6	224.0	70	17.0	3.7	
		3	1	C8-570-3C 40 288	80.0	40.0	246.5	288.0	70	17.0	5.2	
3	1	C8-570-3C 40 368	80.0	40.0	330.9	368.0	70	17.0	5.4			

CXSC=1 deve ser usada com cabeças de corte com refrigeração de precisão

CXSC=3 deve ser usada com cabeças de corte com refrigeração axial

Para componentes, visite www.sandvik.coromant.com



E5



G1



H36



H5



H2

Coromant Capto® para adaptador antivibratório CoroTurn® SL

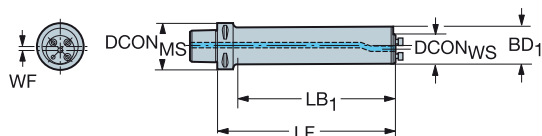

● ● ● SilentTools®

				Dimensões, mm												
CZC _{MS}	CZC _{WS}	CNSC	CXSC	Código para pedido	DCON _{MS}	DCON _{WS}	BD ₁	LB ₁	LF	WF	BAR	NM	KG			
C5	40	3	1	C5-570-3C 50 223-40R/L	50.0	40.0	50.0	223.0	223.0	5.0	70	17.0	3.6			
		3	1	C5-570-3C 50 368-40R/L	50.0	40.0	50.0	368.0	368.0	5.0	70	17.0	6.0			
		3	1	C5-570-3C 50 468-40R/L	50.0	40.0	50.0	468.0	468.0	5.0	70	17.0	7.7			
C6	40	3	1	C6-570-3C 50 247-40R/L	63.0	40.0	50.0	222.0	247.0	5.0	70	17.0	4.2			
		3	1	C6-570-3C 50 368-40R/L	63.0	40.0	50.0	341.2	368.0	5.0	70	17.0	6.0			
		3	1	C6-570-3C 50 468-40R/L	63.0	40.0	50.0	440.0	468.0	5.0	70	17.0	7.4			
		3	1	C6-570-3C 60 295-40R/L	63.0	40.0	60.0	273.0	295.0	10.0	70	17.0	6.8			
		3	1	C6-570-3C 60 448-40R/L	63.0	40.0	60.0	424.8	448.0	10.0	70	17.0	11.0			
C8	40	3	1	C6-570-3C 60 568-40R/L	63.0	40.0	60.0	545.0	568.0	10.0	70	17.0	12.2			
		3	1	C8-570-3C 50 297-40R/L	80.0	40.0	50.0	261.0	297.0	5.0	70	17.0	5.8			
		3	1	C8-570-3C 50 368-40R/L	80.0	40.0	50.0	330.9	368.0	5.0	70	17.0	7.5			
		3	1	C8-570-3C 50 468-40R/L	80.0	40.0	50.0	434.0	468.0	5.0	70	17.0	8.3			
		3	1	C8-570-3C 60 355-40R/L	80.0	40.0	60.0	320.3	355.0	10.0	70	17.0	8.9			
		3	1	C8-570-3C 60 448-40R/L	80.0	40.0	60.0	409.2	448.0	10.0	70	17.0	11.8			
		3	1	C8-570-3C 60 568-40R/L	80.0	40.0	60.0	531.3	568.0	10.0	70	17.0	13.0			

CXSC=1 deve ser usada com cabeças de corte com refrigeração de alta precisão

R = versão direita, L = versão esquerda

Para componentes, visite www.sandvik.coromant.com



E5



G1



H36



H5



H2

A

Coromant Capto® para adaptador antivibratório CoroTurn® SL

Para operações de rosqueamento e usinagem de canais

B

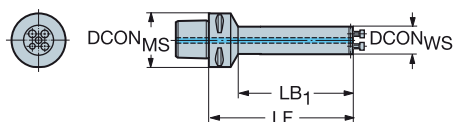

● ● ● SilentTools®

C

					Dimensões, mm							
CZC _{MS}	CZC _{WS}	OHX	CNSC	CXSC	Código para pedido	DCON _{MS}	DCON _{WS}	LB ₁	LF	BAR	NM	KG
C4	40	120.0	3	1	C4-570-4C 40 120	40.0	40.0	120.0	120.0	70	17.0	1.4
C5	40	120.0	3	1	C5-570-4C 40 120	50.0	40.0	98.0	120.0	70	17.0	1.6
C6	40	94.0	3	1	C6-570-4C 40 120	63.0	40.0	94.0	120.0	70	17.0	1.9

D

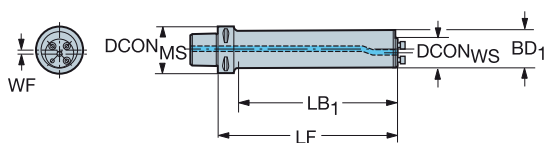

● ● ● SilentTools®

					Dimensões, mm									
CZC _{MS}	CZC _{WS}	OHX	CNSC	CXSC	Código para pedido	DCON _{MS}	DCON _{WS}	BD ₁	LB ₁	LF	WF	BAR	NM	KG
C5	40	150.0	3	1	C5-570-4C 50 150-40R/L	50.0	40.0	50.0	150.0	150.0	5.0	70	17.0	2.5
C6	40	150.0	3	1	C6-570-4C 50 150-40R/L	63.0	40.0	50.0	122.0	150.0	5.0	70	17.0	2.8
		180.0	3	1	C6-570-4C 60 180-40R/L	63.0	40.0	60.0	157.0	180.0	10.0	70	17.0	4.1
C8	40	147.0	3	1	C8-570-4C 60 180-40R/L	80.0	40.0	60.0	147.0	180.0	10.0	70	17.0	4.9

CXSC=1 deve ser usada com cabeças de corte com refrigeração de alta precisão

R = versão direita, L = versão esquerda

Para componentes, visite www.sandvik.coromant.com

F

G

H



E5



G1



H36



H5



H2

Coromant Capto® para adaptador antivibratório CoroTurn® SL

Barra de mandrilar reforçada com metal duro

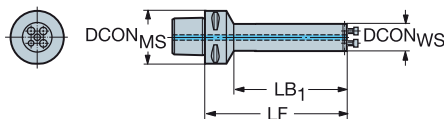

●●●● SilentTools®

				Dimensões, mm							
CZC _{MS}	CZC _{WS}	CNSC	CXSC	Código para pedido	DCON _{MS}	DCON _{WS}	LB ₁	LF	BAR	NM	KG
C6	25	3	1	C6-SL-3C 25 280 CR-M	63.0	25.0	248.2	280.0	70	3.7	2.0
		3	3	C6-SL3C25280CR	63.0	25.0	245.0	280.0	70	3.7	2.0
	32	3	1	C6-SL3C32352CR	63.0	32.0	317.0	352.0	70	8.8	3.5
	40	3	1	C6-SL3C40448CR	63.0	40.0	416.0	448.0	70	17.0	5.5
C8	25	3	1	C8-SL-3C 25 280 CR-M	80.0	25.0	248.2	280.0	70	3.7	3.0
		3	1	C8-SL3C32352CR	80.0	32.0	317.0	352.0	70	8.8	4.5
	40	3	1	C8-SL3C40448CR	80.0	40.0	416.0	448.0	70	17.0	6.5

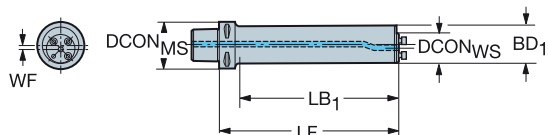

●●●● SilentTools®

				Dimensões, mm									
CZC _{MS}	CZC _{WS}	CNSC	CXSC	Código para pedido	DCON _{MS}	DCON _{WS}	BD ₁	LB ₁	LF	WF	BAR	NM	KG
C8	40	3	1	C8-SL3C50568CR-40R/L	80.0	40.0	50.0	528.0	568.0	5.0	70	17.0	11.0
		3	1	C8-SL3C60688CR-40R/L	80.0	40.0	60.0	648.0	688.0	10.0	70	17.0	17.7

CXSC=1 deve ser usada com cabeças de corte com refrigeração de precisão
CXSC=3 deve ser usada com cabeças de corte com refrigeração axial

R = versão direita, L = versão esquerda

Para componentes, visite www.sandvik.coromant.com



E5



G1



H36



H5



H2

Coromant Capto® para adaptador antivibratório CoroTurn® SL

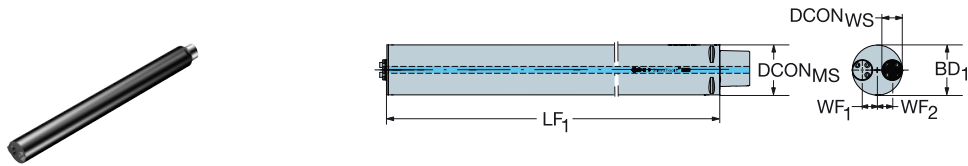

●●●● SilentTools®

Barra de mandrilar para duas cabeças CoroTurn® SL

					Dimensões, mm										
CZC _{MS}	CZC _{WS}	CNSC	CXSC	Código para pedido	DCON _{MS}	DCON _{WS}	BD ₁	LB ₁	LF ₁	LF ₂	WF ₁	WF ₂	BAR	NM	KG
C8	40	3	1	C8-570-3C 80 608-40-2	80.0	40.0	80.0	608.0	608.0	608.0	20.0	20.0	70	17.0	20.6
		3	1	C8-570-3C80365-40-2	80.0	40.0	80.0	365.0	365.0	365.0	20.0	20.0	70	17.0	13.1
C10	40	3	1	C10-SL3C100968-40-2	100.0	40.0	100.0	968.0	968.0	968.0	30.0	30.0	70	17.0	58.0
		3	1	C10-SL3C80768-40-2	100.0	40.0	80.0	729.0	768.0	768.0	20.0	20.0	70	17.0	29.5
C8	40	3	1	C8-570-3C80768-40-2	80.0	40.0	80.0	768.0	768.0	768.0	20.0	20.0	70	17.0	28.2

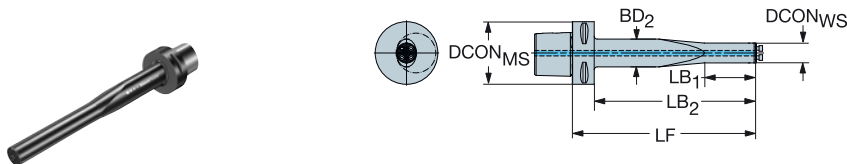

●●●● SilentTools®

Barra de mandrilar elíptica

					Dimensões, mm										
CZC _{MS}	CZC _{WS}	OHX	CNSC	CXSC	Código para pedido	DCON _{MS}	DCON _{WS}	LB ₁	LF	BAR	NM	KG			
C6	16	133.0	3	1	C6-SL-D 23E 133-16	63.0	16.0	46.0	133.0	70	2.0	1.0			
		185.0	3	1	C6-SL-D 28E 185-20	63.0	20.0	52.0	185.0	70	2.8	1.2			
		255.0	3	1	C6-SL-D 35E 230-25	63.0	25.0	64.0	230.0	70	3.7	1.9			
		313.0	3	1	C6-SL-D 45E 313-32	63.0	32.0	102.0	313.0	70	8.8	3.6			
		393.0	3	1	C6-SL-D 56E 393-40	63.0	40.0	124.0	393.0	70	17.0	5.7			
C8	16	133.0	3	1	C8-SL-D 23E 133-16	80.0	16.0	46.0	133.0	70	2.0	2.2			
		185.0	3	1	C8-SL-D 28E 185-20	80.0	20.0	52.0	185.0	70	2.8	2.4			
		230.0	3	1	C8-SL-D 35E 230-25	80.0	25.0	64.0	230.0	70	3.7	3.2			
		313.0	3	1	C8-SL-D 45E 313-32	80.0	32.0	102.0	313.0	70	8.8	4.2			
		393.0	3	1	C8-SL-D 56E 393-40	80.0	40.0	124.0	393.0	70	17.0	6.6			

CXSC=1 deve ser usada com cabeças de corte com refrigeração de alta precisão

Para componentes, visite www.sandvik.coromant.com



Coromant Capto® para adaptador antivibratório CoroTurn® SL troca rápida

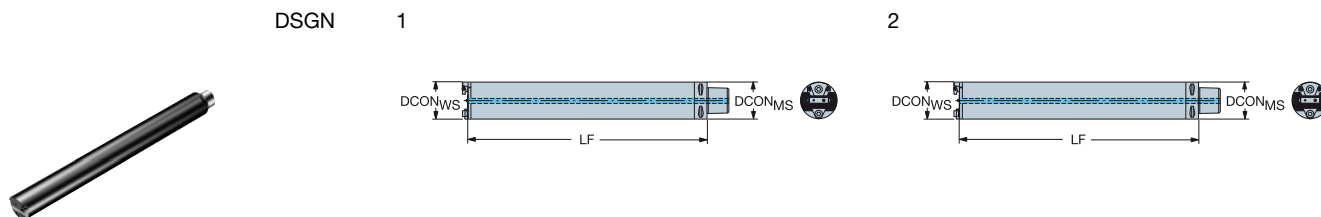

●●● SilentTools®

					Dimensões, mm							
CZC _{MS}	CZC _{WS}	CNSC	CXSC	DSGN	Código para pedido	DCON _{MS}	DCON _{WS}	LB ₁	LF	BAR	NM	KG
C6	80	3	1	1	C6-570-3C 80 355	63.0	80.0	355.0	355.0	70	50.0	12.0
C8	80	3	1	1	C8-570-3C 80 475	80.0	80.0	475.0	475.0	70	50.0	17.1
C10	100/80	3	1	1	C10-570-3C100955-80	100.0	100.0	955.0	955.0	70	50.0	55.8
	80	3	1	2	C10-570-3C80755-80	100.0	80.0	714.0	755.0	70	50.0	29.0

CXSC=1 deve ser usada com cabeças de corte com refrigeração de alta precisão

Para componentes, visite www.sandvik.coromant.com



E5



G1



H36



H5



H2

Interface HSK do lado da máquina

B

C

D

E

F

G

H

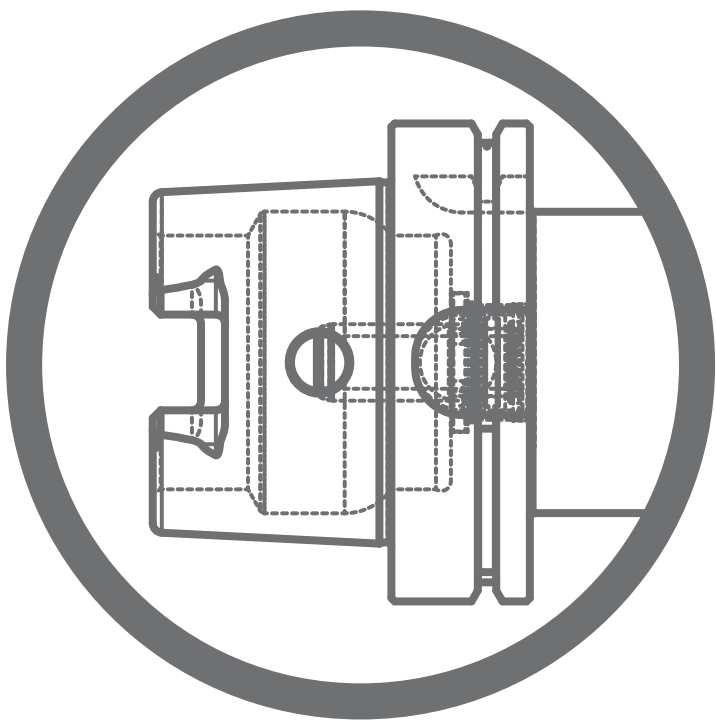

HSK para adaptador CoroTurn® SL com mecanismo antivibratório

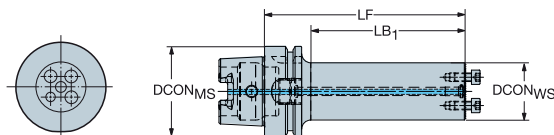

● ● ● SilentTools®

				Dimensões, mm							
CZC _{MS}	CZC _{WS}	CNSC	CXSC	Código para pedido	DCON _{MS}	DCON _{WS}	LB ₁	LF	BAR	NM	KG
63	32	1	1	HT06-SL32D-172	63.0	32.0	143.0	172.0	70	8.8	1.8
				HT06-SL40D-208	63.0	40.0	179.0	208.0	70	17.0	2.7
100	40	1	1	HT10-SL40D-208	100.0	40.0	176.0	208.0	70	17.0	4.0

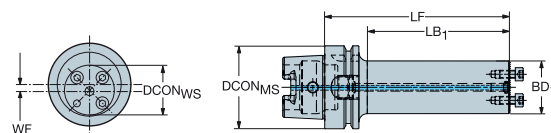

● ● ● SilentTools®

				Dimensões, mm									
CZC _{MS}	CZC _{WS}	CNSC	CXSC	Código para pedido	DCON _{MS}	DCON _{WS}	BD ₁	LB ₁	LF	WF	BAR	NM	KG
63	40	1	1	HT06-SL50D-268-40R	63.0	40.0	50.0	239.0	268.0	5.0	70	17.0	4.6
				HT10-SL50D-268-40R	100.0	40.0	50.0	236.0	268.0	5.0	70	17.0	5.8
				HT10-SL60D-328-40R	100.0	40.0	60.0	296.0	328.0	10.0	70	17.0	8.7

CXSC=1 deve ser usada com cabeças de corte com refrigeração de alta precisão

R = versão direita

Para a lista completa de componentes, acesse www.sandvik.coromant.com



H36



H5

Interface do lado da máquina Haste cilíndrica

B

C

D

E

F

G

H

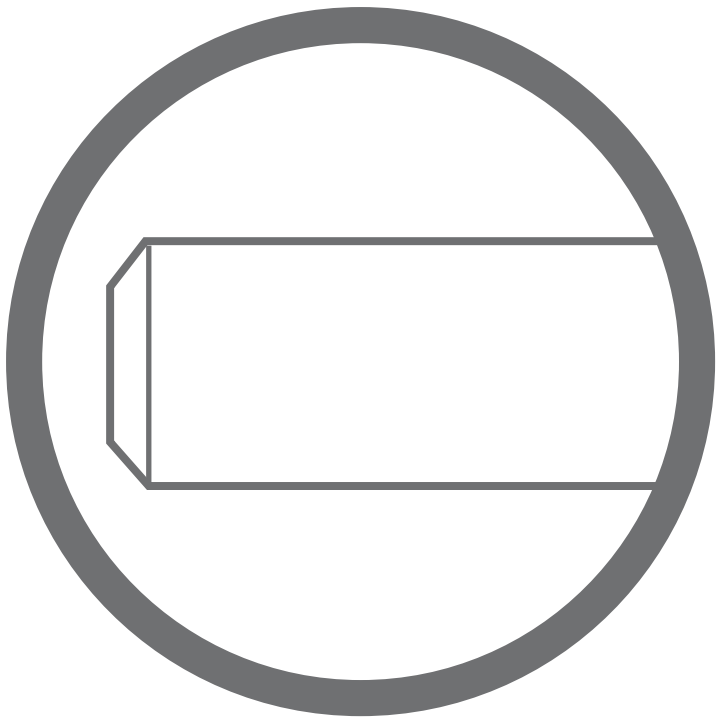

Haste cilíndrica para adaptador antivibratório Coromant Capto®

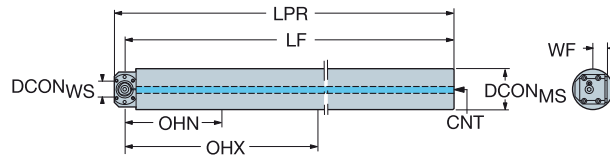

● ● ● SilentTools®

							Dimensões, mm										
CZC _{MS}	CZC _{WS}	OHN	OHX	CNSC	CXSC	Código para pedido	DCON _{MS}	DCON _{WS}	LB _I	LPR	LF	WF	CNT	BAR	NM	KG	
80	C3	298.0	778.0	1	1	CU-3C801200-C3	80.0	32.0	1234.0	1234.0	1215.0	37.0	G 3/4-14	70	35.0	58.0	
100	C3	378.0	978.0	1	1	CU-3C1001500-C3	100.0	32.0	1534.0	1534.0	1515.0	26.0	G 3/4-14	70	35.0	103.0	
	C4	373.0	973.0	1	1	CU-3C1001500-C4	100.0	40.0	1544.0	1544.0	1520.0	41.0	G 3/4-14	70	50.0	90.0	

CXSC=1 deve ser usada com cabeças de corte com refrigeração de alta precisão
Para componentes, visite www.sandvik.coromant.com



H36



H5

Haste cilíndrica para adaptador CoroTurn® SL antivibratório



570-3C

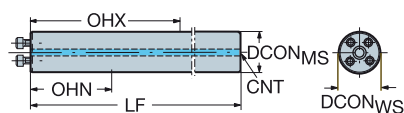

570-3C..-40

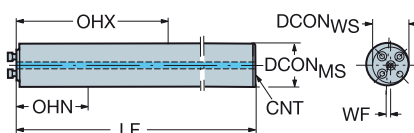

●●● SilentTools®

							Dimensões, mm									
CZC _{MS}	CZC _{WS}	OHN	OHX	CNSC	CXSC	Código para pedido	DCON _{MS}	DCON _{WS}	LF	WF	CNT	BAR	NM	KG		
16	16	55.0	92.0	1	3	570-3C 16 156	16.0	16.0	156.0	0.0	G 1/8-28	70	2.0	0.2		
20	20	70.0	120.0	1	3	570-3C 20 200	20.0	20.0	200.0	0.0	G 1/4-19	70	2.8	0.4		
25	25	88.0	158.0	1	3	570-3C 25 255	25.0	25.0	255.0	0.0	G 1/4-19	70	3.7	0.9		
		155.0	230.0	1	3	570-3C 25 330	25.0	25.0	330.0	0.0	G 1/4-19	70	3.7	1.2		
		88.0	158.0	1	1	SL-3C 25 255	25.0	25.0	255.0	0.0	G 1/4-19	70	3.7	0.9		
32	32	155.0	230.0	1	1	SL-3C 25 330	25.0	25.0	330.0	0.0	G 1/4-19	70	3.7	1.2		
		100.0	192.0	1	1	570-3C 32 320	32.0	32.0	320.0	0.0	G 3/8-19	70	8.8	1.9		
40	40	128.0	248.0	1	1	570-3C 32 416	32.0	32.0	416.0	0.0	G 3/8-19	70	8.8	2.6		
		192.0	288.0	1	1	570-3C 40 408	40.0	40.0	408.0	0.0	G 1/2-14	70	17.0	3.5		
50	40	248.0	368.0	1	1	570-3C 40 528	40.0	40.0	528.0	0.0	G 1/2-14	70	17.0	5.1		
		168.0	318.0	1	1	570-3C 50 518-40	50.0	40.0	518.0	5.0	G 1/2-14	70	17.0	7.3		
60	40	318.0	468.0	1	1	570-3C 50 668-40	50.0	40.0	668.0	5.0	G 1/2-14	70	17.0	9.3		
		208.0	388.0	1	1	570-3C 60 628-40	60.0	40.0	628.0	10.0	G 3/4-14	70	17.0	12.7		
		388.0	568.0	1	1	570-3C 60 808-40	60.0	40.0	808.0	10.0	G 3/4-14	70	17.0	16.5		

EasyFix para 16-25 mm

CXSC=1 deve ser usada com cabeças de corte com refrigeração de precisão
 CXSC=3 deve ser usada com cabeças de corte com refrigeração axial

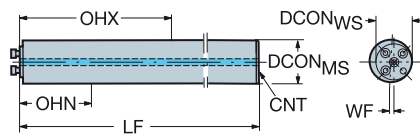

●●● SilentTools®

Para operações de rosqueamento e usinagem de canais

							Dimensões, mm									
CZC _{MS}	CZC _{WS}	OHN	OHX	CNSC	CXSC	Código para pedido	DCON _{MS}	DCON _{WS}	LF	WF	CNT	BAR	NM	KG		
40	40	80.0	128.0	1	1	570-4C 40 330	40.0	40.0	330.0	0.0	G 1/2-14	70	17.0	3.1		
50	40	90.0	168.0	1	1	570-4C 50 430-40	50.0	40.0	430.0	5.0	G 1/2-14	70	17.0	6.3		
60	40	90.0	208.0	1	1	570-4C 60 510-40	60.0	40.0	510.0	10.0	G 3/4-14	70	17.0	10.1		

CXSC=1 deve ser usada com cabeças de corte com refrigeração de alta precisão

Para componentes, visite www.sandvik.coromant.com



Haste cilíndrica para adaptador CoroTurn® SL antivibratório

Barra de mandrilhar reforçada com metal duro

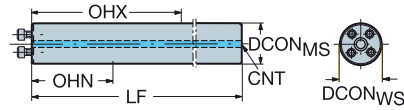

●●● SilentTools®

							Dimensões, mm							
CZC _{MS}	CZC _{WS}	OHN	OHX	CNSC	CXSC	Código para pedido	DCON _{MS}	DCON _{WS}	LF	WF	CNT	BAR	NM	KG
16	16	96.0	140.0	1	3	570-3C 16 204 CR	16.0	16.0	204.0	0.0		70	2.0	0.4
20	20	120.0	180.0	1	3	570-3C 20 260 CR	20.0	20.0	260.0	0.0		70	2.8	0.8
25	25	230.0	280.0	1	3	570-3C 25 380 CR	25.0	25.0	380.0	0.0	G 1/8-28	70	3.7	6.3
		280.0	330.0	1	3	570-3C 25 430 CR	25.0	25.0	430.0	0.0	G 1/8-28	70	3.7	6.4
		225.0	280.0	1	1	SL-3C 25 380 CR	25.0	25.0	380.0	0.0	G 1/8-28	70	3.7	6.0
		275.0	330.0	1	1	SL-3C 25 430 CR	25.0	25.0	430.0	0.0	G 1/8-28	70	3.7	6.2
32	32	288.0	352.0	1	1	570-3C 32 480 CR	32.0	32.0	480.0	0.0	G 1/4-19	70	8.8	10.2
		352.0	416.0	1	1	570-3C 32 544 CR	32.0	32.0	544.0	0.0	G 1/4-19	70	8.8	8.0
40	40	368.0	448.0	1	1	570-3C 40 608 CR	40.0	40.0	608.0	0.0	G 3/8-19	70	17.0	11.0
		448.0	528.0	1	1	570-3C 40 688 CR	40.0	40.0	688.0	0.0	G 3/8-19	70	17.0	13.0
50	40	468.0	568.0	1	1	570-3C 50 760-40 CR	50.0	40.0	760.0	5.0	G 1/2-14	70	17.0	22.0
		568.0	668.0	1	1	570-3C 50 861-40 CR	50.0	40.0	861.0	5.0	G 1/2-14	70	17.0	22.5
60	40	688.0	808.0	1	1	570-3C 60 1040-40 CR	60.0	40.0	1040.0	10.0	G 3/4-14	70	17.0	25.7
		588.0	688.0	1	1	570-3C 60 920-40 CR	60.0	40.0	920.0	10.0	G 3/4-14	70	17.0	28.0

EasyFix para 16-25 mm

CXSC=1 deve ser usada com cabeças de corte com refrigeração de precisão
CXSC=3 deve ser usada com cabeças de corte com refrigeração interna

Para componentes, visite www.sandvik.coromant.com



H36



H5



H2

Haste cilíndrica para adaptador CoroTurn® SL troca rápida antivibratório

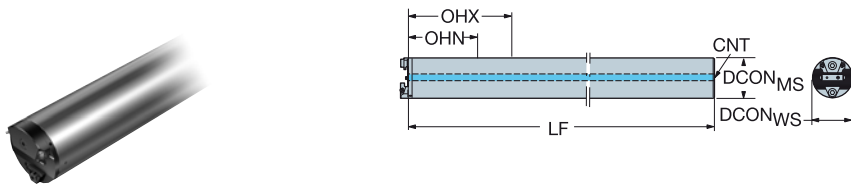

●●●● SilentTools®

						Dimensões, mm							
CZC _{MS}	CZC _{WS}	OHN	OHX	CNSC	CXSC	Código para pedido	DCON _{MS}	DCON _{WS}	LF	CNT	BAR	NM	KG
80	80	360.0	755.0	1	1	570-3C 80 1200	80.0	80.0	1200.0	G 3/4-14	70	50.0	43.4
		360.0	515.0	1	1	570-3C 80 880	80.0	80.0	880.0	G 3/4-14	70	50.0	31.3
100	100/80	415.0	655.0	1	1	570-3C 100 1100	100.0	100.0	1100.0	G 3/4-14	70	50.0	63.0
		415.0	955.0	1	1	570-3C 100 1500	100.0	100.0	1500.0	G 3/4-14	70	50.0	65.0

Barra de mandrilar reforçada com metal duro

						Dimensões, mm							
CZC _{MS}	CZC _{WS}	OHN	OHX	CNSC	CXSC	Código para pedido	DCON _{MS}	DCON _{WS}	LF	CNT	BAR	NM	KG
80	80	755.0	916.0	1	1	570-3C 80 1240 CR	80.0	80.0	1240.0	G 3/4-14	70	50.0	40.0
		916.0	1076.0	1	1	570-3C 80 1400 CR	80.0	80.0	1400.0	G 3/4-14	70	50.0	80.0
100	100/80	955.0	1155.0	1	1	570-3C 100 1560 CR	100.0	100.0	1560.0	G 3/4-14	70	50.0	125.0
		1155.0	1355.0	1	1	570-3C 100 1760 CR	100.0	100.0	1760.0	G 3/4-14	70	50.0	150.0

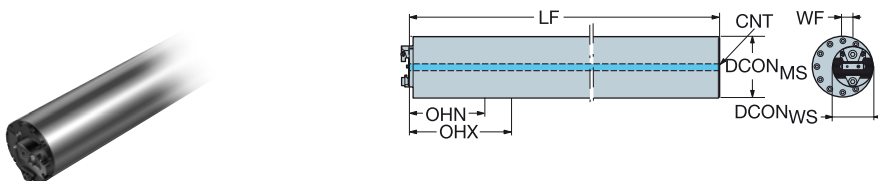

●●●● SilentTools®

						Dimensões, mm								
CZC _{MS}	CZC _{WS}	OHN	OHX	CNSC	CXSC	Código para pedido	DCON _{MS}	DCON _{WS}	LF	WF	CNT	BAR	NM	KG
120	80	795.0	1155.0	1	1	570-3C 120 1900R	120.0	80.0	1900.0	20.0	G 3/4-14	70	50.0	133.7
130	80	865.0	1255.0	1	1	570-3C 130 2000R	130.0	80.0	2000.0	25.0	G 3/4-14	70	50.0	188.0
140	80	935.0	1355.0	1	1	570-3C 140 2200R	140.0	80.0	2200.0	30.0	G 3/4-14	70	50.0	241.0
150	80	1005.0	1455.0	1	1	570-3C 150 2400R	150.0	80.0	2400.0	35.0	G 3/4-14	70	50.0	252.3
160	80	1075.0	1555.0	1	1	570-3C 160 2600R	160.0	80.0	2600.0	40.0	G 3/4-14	70	50.0	339.0
180	80	1215.0	1755.0	1	1	570-3C 180 2800R	180.0	80.0	2800.0	50.0	G 3/4-14	70	50.0	474.0
200	80	1355.0	1955.0	1	1	570-3C 200 3200R	200.0	80.0	3200.0	59.5	G 1"-11	70	50.0	728.0
220	80	1495.0	2155.0	1	1	570-3C 220 3450R	220.0	80.0	3450.0	70.0	G 1"-11	70	50.0	546.0
250	80	1705.0	2455.0	1	1	570-3C 250 4000R	250.0	80.0	4000.0	85.0	G 1"-11	70	50.0	980.1

CXSC=1 deve ser usada com cabeças de corte com refrigeração de alta precisão

Para componentes, visite www.sandvik.coromant.com

Se o balanço 16xD for necessário, entre em contato com o representante local



H36



H5



H2

Acessórios

Buchas e pinças	G2-G5
Limitador para sistema de fixação QS™	G6
Conectores para refrigeração	G7-G8
Coromant Capto®	G9-G14
CoroTurn® SL	G18-G19
Torquímetro e pontas	G20

EasyFix™

Buchas para barras cilíndricas

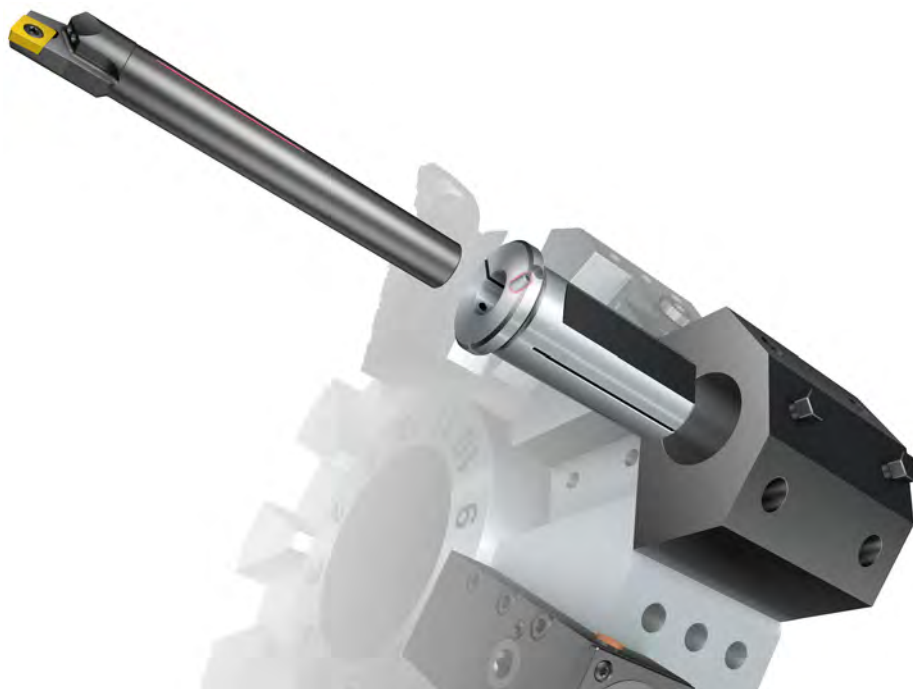

Características e benefícios

- Tempo de set-up rápido
- Simples de usar
- Vida útil da ferramenta mais longa
- Excelente acabamento superficial
- Posição e altura de centro da aresta de corte corretas

Refrigeração de precisão

O canal na bucha cilíndrica é vedado metalicamente, o que permite o uso do sistema de refrigeração existente. A vedação metálica oferece bom desempenho também para refrigeração de alta pressão.

- Vedação de silício para refrigeração com pressão até 20 bar (290 psi)
- Vedação metálica para refrigeração com pressão até 150 bar (2200 psi)

Corrija sempre a altura de centro

A solução de mecanismo tipo mola (pino esférico com mola) na bucha e o canal da barra fornecem a altura de centro correta da pastilha sempre que você fizer o set-up da ferramenta.



Bucha cilíndrica com posicionamento EasyFix™

ISO 9766

Selada metalicamente para refrigeração de alta pressão através da ferramenta

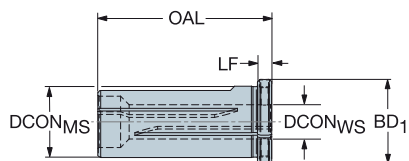

					Dimensões, mm									
CZC _{MS}	CZC _{WS}	CNSC	CXSC	Código para pedido	DCON _{MS}	DCON _{WS}	BD	H	LSC	OAL	LF	BAR	KG	
16	5	1	1	EF-16-05	16	5	21	14	43.0	48	5	150	0.070	
	6	1	1	EF-16-06	16	6	21	14	43.0	48	5	150	0.070	
	8	1	1	EF-16-08	16	8	21	14	43.0	48	5	150	0.067	
	10	1	1	EF-16-10	16	10	21	14	43.0	48	5	150	0.050	
	12	1	1	EF-16-12	16	12	21	14	43.0	48	5	150	0.051	
20	5	1	1	EF-20-05	20	5	25	18	50.0	55	5	150	0.120	
	6	1	1	EF-20-06	20	6	25	18	50.0	55	5	150	0.118	
	8	1	1	EF-20-08	20	8	25	18	50.0	55	5	150	0.115	
	10	1	1	EF-20-10	20	10	25	18	50.0	55	5	150	0.109	
	12	1	1	EF-20-12	20	12	25	18	50.0	55	5	150	0.099	
	16	1	1	EF-20-16	20	16	25	18	50.0	55	5	150	0.066	
25	5	1	1	EF-25-05	25	5	30	23	56.0	61	5	150	0.208	
	6	1	1	EF-25-06	25	6	30	23	56.0	61	5	150	0.199	
	8	1	1	EF-25-08	25	8	30	23	56.0	61	5	150	0.200	
	10	1	1	EF-25-10	25	10	30	23	56.0	61	5	150	0.190	
	16	1	1	EF-25-16	25	16	30	23	56.0	61	5	150	0.150	
	12	1	1	EF-25-12	25	12	30	23	80.0	61	5	150	0.178	
	20	1	1	EF-25-20	25	20	30	23	80.0	61	5	150	0.080	
32	5	1	1	EF-32-05	32	5	36	30	80.0	65	5	150	0.344	
	6	1	1	EF-32-06	32	6	36	30	80.0	65	5	150	0.345	
	8	1	1	EF-32-08	32	8	36	30	80.0	65	5	150	0.340	
	10	1	1	EF-32-10	32	10	36	30	80.0	65	5	150	0.350	
	12	1	1	EF-32-12	32	12	36	30	80.0	65	5	150	0.332	
	16	1	1	EF-32-16	32	16	36	30	80.0	65	5	150	0.299	
	20	1	1	EF-32-20	32	20	36	30	80.0	65	5	150	0.269	
	25	1	1	EF-32-25	32	25	36	30	80.0	65	5	150	0.120	
40	5	1	1	EF-40-05	40	5	44	38	100.0	75	5	150	0.606	
	6	1	1	EF-40-06	40	6	44	38	100.0	75	5	150	0.604	
	8	1	1	EF-40-08	40	8	44	38	100.0	75	5	150	0.620	
	10	1	1	EF-40-10	40	10	44	38	100.0	75	5	150	0.632	
	12	1	1	EF-40-12	40	12	44	38	100.0	75	5	150	0.629	
	16	1	1	EF-40-16	40	16	44	38	100.0	75	5	150	0.587	
	20	1	1	EF-40-20	40	20	44	38	100.0	75	5	150	0.562	
	25	1	1	EF-40-25	40	25	44	38	100.0	75	5	150	0.461	

B

C

D

E

F

G

H



F20



H36

A

ACESSÓRIOS

Buchas e pinças

Bucha cilíndrica com posicionamento EasyFix™

B

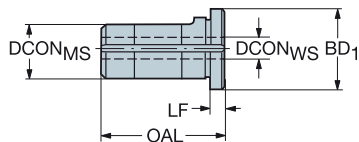

C

					Dimensões, mm									
CZC _{MS}	CZC _{WS}	CNSC	CXSC	Código para pedido	DCON _{MS}	DCON _{WS}	BD	H	LSC	OAL	LF	BAR	KG	
32	20	1	1	132L-3220085-B	32	20	38	30	80.0	85	5	20	0.326	
40	20	1	1	132L-4020105-B	40	20	46	38	100.0	105	5	20	0.758	
	25	1	1	132L-4025105-B	40	25	46	38	100.0	105	5	20	0.620	
50	20	1	1	132L-5020125-B	50	20	56	47	120.0	125	5	20	1.576	
	25	1	1	132L-5025125-B	50	25	56	47	120.0	125	5	20	1.396	

Ranhura para bucha EasyFix está disponível em todas as barras de mandril cilíndricas no diâmetro 5-25 mm

Bucha cilíndrica

D

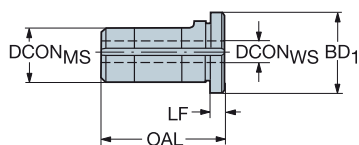

E

					Dimensões, mm									
CZC _{MS}	CZC _{WS}	CNSC	CXSC	Código para pedido	DCON _{MS}	DCON _{WS}	BD	LSC	OAL	LF	BAR	KG		
40	32	1	1	132L-40-32	40	32	50	123.0	128	5	150	0.430		
50	32	1	1	132L-50-32	50	32	60	123.0	128	5	150	1.100		
	40	1	1	132L-50-40	50	40	60	155.0	160	5	150	0.840		
60	32	1	1	132L-60-32	60	32	70	123.0	128	5	150	1.900		
	40	1	1	132L-60-40	60	40	70	155.0	160	5	150	1.900		
	50	1	1	132L-60-50	60	50	70	195.0	200	5	150	1.300		

Parafuso inferior (sem EasyFix)

F

G

H



H36

G 4

SANDVIK
Coromant

Bucha quadrada com posicionamento Easy-Fix

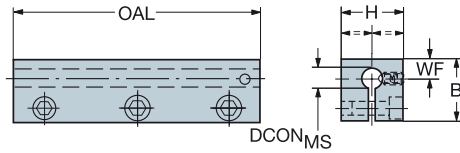

		Dimensões, mm									
CZC _{MS}	CZC _{WS}	Código para pedido	DCON _{MS}	B	H	LSC	OAL	WF	HF	(KG)	
20 x 20	5	131-2005-B	5	20	20	80.0	80	5.5	10.0	0.232	
	6	131-2006-B	6	20	20	80.0	80	6.0	10.0	0.228	
	8	131-2008-B	8	20	20	80.0	80	7.0	10.0	0.218	
	10	131-2010-B	10	20	20	80.0	80	7.5	10.0	0.201	
25 x 25	12	131-2512-B	12	25	25	80.0	80	9.0	12.5	0.328	
	16	131-2516-B	16	25	25	80.0	80	10.0	12.5	0.276	
32 x 40	20	131-3220-B	20	40	32	100.0	100	12.0	16.0	0.752	
	25	131-3225-B	25	40	32	100.0	100	14.5	16.0	0.630	



H36

A

Limitador para sistema de fixação QS™

B

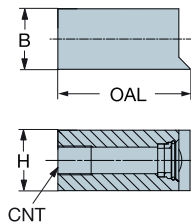
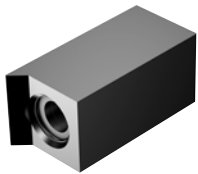

C

Dimensões, mm

Código para pedido	OAL	B	H	CNT
QS-2020HP	44.0	20.0	20.0	G1/8"
QS-2525HP	44.0	25.0	25.0	G1/8"

D

E

F

G

H



H36

Kit de conexão para refrigeração

Refrigeração de precisão











Comprimento do tubo, mm	Reta para conexão reta			Banjo para conexão reta			Banjo para conexão banjo		
	Kit	Componentes incluídos	Pçs	Kit	Componentes incluídos	Pçs	Kit	Componentes incluídos	Pçs
150	5693 066-011	5693 066-01 ¹⁾	1	5693 067-011	5693 067-01 ¹⁾	1	5693 068-011	5693 068-01 ¹⁾	1
		5692 063-01	1		5692 063-01	1		5692 063-01	1
		5692 063-02	1		5692 063-02	1		5692 063-02	1
		5692 063-03	2		5692 063-03	1		5692 063-03	1
		5692 063-04	1		5692 063-05	1		5692 063-04	1
		5692 063-08	2		5692 063-06	1		5692 063-05	2
200	5693 066-021	5693 066-02 ¹⁾	1	5693 067-021	5693 067-02 ¹⁾	1	5693 068-021	5693 068-02 ¹⁾	1
		5692 063-01	1		5692 063-01	1		5692 063-01	1
		5692 063-02	1		5692 063-02	1		5692 063-02	1
		5692 063-03	2		5692 063-03	1		5692 063-03	1
		5692 063-04	1		5692 063-05	1		5692 063-04	2
		5692 063-08	2		5692 063-06	1		5692 063-05	1
250	5693 066-031	5693 066-03 ¹⁾	1	5693 067-031	5693 067-03 ¹⁾	1	5693 068-031	5693 068-03 ¹⁾	1
		5692 063-01	1		5692 063-01	1		5692 063-01	1
		5692 063-02	1		5692 063-02	1		5692 063-02	1
		5692 063-03	2		5692 063-03	1		5692 063-03	1
		5692 063-04	1		5692 063-05	1		5692 063-04	2
		5692 063-08	2		5692 063-06	1		5692 063-05	1
300	5693 066-041	5693 066-04 ¹⁾	1	5693 067-041	5693 067-04 ¹⁾	1	5693 068-041	5693 068-04 ¹⁾	1
		5692 063-01	1		5692 063-01	1		5692 063-01	1
		5692 063-02	1		5692 063-02	1		5692 063-02	1
		5692 063-03	2		5692 063-03	1		5692 063-03	1
		5692 063-04	1		5692 063-05	1		5692 063-04	2
		5692 063-08	2		5692 063-06	1		5692 063-05	1
				5692 063-07	1	5692 063-06	2		
				5692 063-08	3	5692 063-07	1		
						5692 063-08	4		

¹⁾ Mangueira. Não pode ser pedida separadamente.

Outros componentes incluídos podem ser pedidos separadamente. A quantidade mínima para pedido é de 2 pçs.

Componentes incluídos

							
Plugue de conexão de refrigeração VDI G1/8\" data-bbox="71 808 178 838"/>	Plugue de bloqueio de refrigeração para VDI G1/8\" data-bbox="181 818 288 838"/>	G1/8\" data-bbox="298 823 368 838"/>	M10x1.5 5692 063-04	M10x1.5 5692 063-05	G1/8\" data-bbox="598 833 668 848"/>	G1/4\" data-bbox="701 828 841 843"/>	Arruela (M10) 5692 063-08

INFORMAÇÃO: Esse kit de conexão de refrigeração substitui os tubos CoroTurn HP (e tubo de extensão do adaptador 5692 067-01) 5693 065-01, 5693 065-02, 5693 065-03. "Kit de conexão CoroTurn HP" (5692 070-01) também está disponível para pedido para: conexão de tubo em aço ou cobre de Ø 6mm com acessórios; (5692 061-01) e (5692 062-01).

Conectores para refrigeração

FOR

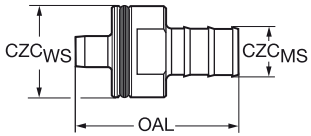
B	Para diâmetro da barra	Código para pedido	Dimensões, mm		
			D _{CON_{MS}}	CZC _{MS}	CZC _{WS}
	6	CS-060-054	5.4	6.0	25.0
	8	CS-080-066	6.6	8.0	28.5
	10	CS-100-086	8.6	10.0	28.5
	12	CS-120-086	8.6	12.0	38.0
	16	CS-160-137	13.7	16.0	40.0
	20	CS-200-137	13.7	20.0	40.0
	25	CS-250-137	13.7	25.0	44.0

C

D

E

F

G

H

Coromant Capto®

Três sistemas em um

Aplicação

- Coromant Capto trabalha em todos os tipos de máquinas
- Centros de torneamento - troca rápida e refrigeração de alta pressão
- Máquinas multitarefas e centros de usinagem - interface de fuso rotativo, ferramentas modulares e troca rápida
- Disponível em seis tamanhos, há uma solução Coromant Capto flexível para todas as necessidades: C3-C10



Características e benefícios

- Flexível com modularidade ampliada
- Alta precisão e estabilidade básicas
- Estoque de ferramentas minimizado
- Tempo de set-up reduzido
- Alta transmissão de torque
- Alta resistência à deflexão
- Troca de ferramenta rápida e automatizada
- Tecnologia avançada de olhal para processo seguro mesmo com pressões baixas
- Refrigeração interna de alta pressão, da máquina até a aresta de corte
- Balanceado e concêntrico
- Autocentrante

Troca rápida

- Centros de torneamento
- Tornos verticais

Porta-ferramentas acionados e unidades de fixação Coromant Capto reduzem o tempo de set-up e de troca da ferramenta para maior utilização da máquina.

Fuso integrado

- Máquinas multitarefas
- Tornos verticais
- Centros de usinagem com opção de torneamento

O Coromant Capto integrado ao fuso agrega estabilidade e versatilidade.

Sistema modular

- Centros de usinagem
- Máquinas multitarefas
- Tornos verticais

Os adaptadores Coromant Capto de interface de máquina combinados com os adaptadores de extensão e redução permitem a montagem de ferramentas com diferentes comprimentos e desenhos independentemente da interface da máquina.

Gama Coromant Capto®

O programa Coromant Capto inclui adaptadores de interface da máquina, unidades de fixação, porta-ferramentas, ferramentas de corte integradas, adaptadores e mandris.



Dispositivo de montagem

Dispositivo do corpo
Código para pedido:

Corpo do dispositivo de fixação para buchas
Código para pedido:

391.500

391.501

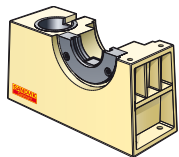

Código para pedido

Código para pedido



Bucha	Tipo de suporte, tamanho
391.540-C3	Coromant Capto tamanho C3
391.540-C4	Coromant Capto tamanho C4
391.540-C5	Coromant Capto tamanho C5
391.540-C6	Coromant Capto tamanho C6
391.540-C8	Coromant Capto Tamanho C8
391.540-C10	Coromant Capto tamanho C10
391.540-HA04	HSK 40 Formato A/C
391.540-HA05	HSK 50 Formato A/C
391.540-HA06	HSK 63 Formato A/C
391.540-HA08	HSK 80 Formato A/C
391.540-HA10	HSK 100 Formato A/C
391.540-30	MAS-BT/CAT/ISO 30
391.540-40	MAS-BT/CAT/ISO 40
391.540-50	MAS-BT/CAT/ISO 50

Flange	Anel	Tipo de suporte, tamanho
391.510-140 50	391.530-C3	Coromant Capto tamanho C3
391.510-140 50	391.530-C4	Coromant Capto tamanho C4
391.510-140 50	391.530-C5	Coromant Capto tamanho C5
391.510-140 50	391.530-C6	Coromant Capto tamanho C6
391.510-140 50	391.530-C8	Coromant Capto Tamanho C8
	391.530-C10*	Coromant Capto tamanho C10
391.510-HA04		HSK 40 Formato A
391.510-HA05		HSK 50 Formato A
391.510-HA06		HSK 63 Formato A
391.510-HA08		HSK 80 Formato A
391.510-HA10		HSK 100 Formato A
391.510-HA12		HSK 125 Formato A
391.510-55 30		MAS-BT 30
391.510-55 40		MAS-BT 40
391.510-55 50		MAS-BT 50
391.510-562-40		BIG-PLUS, MAS-BT 40
391.510-562-50		BIG-PLUS, MAS-BT 50
391.510-140 40		DIN 69871/40, ANSIB 5.50-40. ISO7388/1-40, CAT 40
391.510-140 50		DIN 69871/50, ANSIB 5.50-40. ISO7388/1-50, CAT 50
391.510-540 40		BIG-PLUS DIN69871/1-40, BIG-PLUS 7388/1-40, CAT 40
391.510-540 50		BIG-PLUS DIN69871/1-50, BIG-PLUS 7388/1-50, CAT 50
391.510-00 40		DIN 2080-40/NMTB 40
391.510-00 50		DIN 2080-50/NMTB 50
A391.510-45 40		ANSIB 5.50-2009, CAT-V 40-2009
A391.510-45 50		ANSIB 5.50-2009, CAT-V 50-2009
A391.510-545 40		BIG-PLUS ANSIB 5.50-2009, CAT-V 40-2009
A391.510-545 50		BIG-PLUS ANSIB 5.50-2009, CAT-V 50-2009

Nota: A chave é fornecida com a bucha.

* colar e flange combinados

Dispositivo de montagem 391.500

Dispositivo 391.501 para manutenção de ferramentas com acoplamentos Coromant Capto e HSK

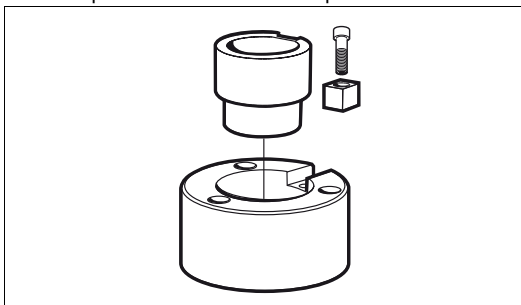
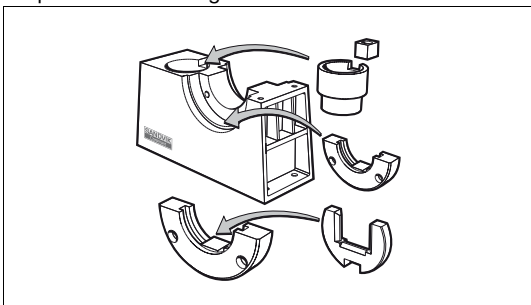

Escolha a flange, o anel e a bucha adequados à ferramenta a ser montada

Escolha a bucha adequada ao acoplamento. O dispositivo deve ser fixado à bancada com três parafusos (não fornecidos com o dispositivo)

Carrinho de ferramentas para Coromant Capto

Ferramentas de troca rápida



1. Suporte da bandeja
2. Bandejas de ferramentas
3. Suportes injetados (devem ser pedidos separadamente)

Código para pedido	O kit consiste em:		
CCW-KIT	TC-0	4 peças	Bandejas de ferramentas
	TCC-2	4 pares	Suportes para bandejas de ferramentas

Para solicitar um carrinho completo 1 pç CCW-KIT + porta-ferramentas

Bancada vertical



Código para pedido
BS-KIT

Para solicitar uma bancada vertical completa 1 pç BS-KIT + suportes injetados

Suportes injetados - devem ser pedidos separadamente



Código para pedido	Largura (B)	Número máx. de suportes em uma bandeja
C3-IC-1	58	C3 = 9
C4-IC-1	58	C4 = 9
C5-IC-1	65.5	C5 = 8
C6-IC-1	81.5	C6 = 6
C8-IC-1	105	C8 = 5
C10-IC-1	120	C10 = 4

Cassetes (assento poligonal)

Coromant Capto®

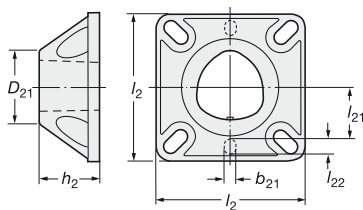
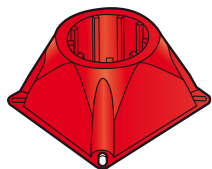
**-4000**

Cassetes de plástico para armazenagem (cor vermelha)

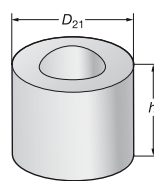
-6000-B

Blanks de alumínio para cassetes

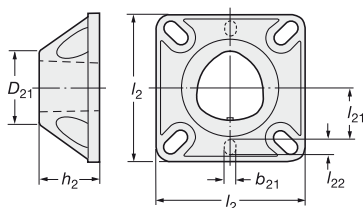
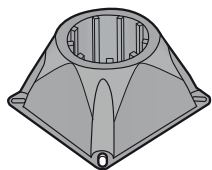
**-5000**

Cassete de plástico de alta resistência para armazenagem de ferramentas na máquina (cor preta)

Tamanho do acoplamento	Código para pedido	Dimensões, mm						Todos os cassetes de plástico conforme padrão de furo nos tamanhos 17 mm, 20 mm, 25 mm e 1".
		b_{21}	D_{21}	h_2	l_2	l_{21}	l_{22}	
C3	C3-C-4000	-	32	26	65	-	-	Plástico de alta resistência. Cor vermelha. Deve ser usado: - sozinho para estoque em posição vertical - com mecanismo tipo PL-01 para posição horizontal ou vertical
C4	C4-C-4000	6	50	39	74	26	8	
C5	C5-C-4000	6	50	39	74	26	8	
C6	C6-C-4000	8	80	63	116	41	10	
C8	C8-C-4000	8	80	63	116	41	10	Plástico de alta resistência reforçado (cor preta). Para armazenagem de ferramentas na máquina com mecanismo AL-01.
C4	C4-C-5000	6	50	39	74	26	8	
C5	C5-C-5000	6	50	39	74	26	8	
C6	C6-C-5000	8	80	63	116	41	10	
C8	C8-C-5000	8	80	63	116	41	10	
C10	C10-C-5000	8	100	80	150	60	68	Blanks de alumínio para cassete, para adaptação individual. Deve ser usado com AL-01.
C6	C6-C-6000-B	-	120	63	-	-	-	
C8	C8-C-6000-B	-	120	63	-	-	-	
C10	C10-C-6000-B	-	138	80	-	-	-	

Mecanismo de trava para cassetes

-PL

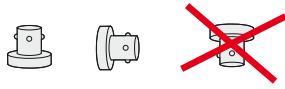
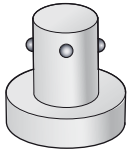

Mecanismo de travamento passivo

Para armazenar no sentido vertical para cima e horizontal. NUNCA armazenar invertido.

-AL

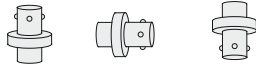
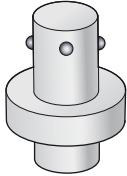

Mecanismo de travamento ativo

Para armazenar em todos os ângulos: vertical para cima e para baixo ou horizontal.

CZC	Código para pedido	Força de ação de empuxe, N	
C4	C4-PL-01	55	Mecanismo de trava central passivo. Fixação por mecanismo com mola. Encaixa-se diretamente em todos os cassetes tipo 4000.
C5	C5-PL-01	120	
C6	C6-PL-01	150	
C8	C8-PL-01	240	
CZC	Código para pedido	Peso da ferramenta máx. recomendado, Kg	
C4	C4-AL-01	40	Mecanismo de trava ativo – ação mecânica de empuxe. Encaixa-se diretamente em todos os cassetes tipo 5000/6000.
C5	C5-AL-01	60	
C6	C6-AL-01	75	
C8	C8-AL-01	110	
C10	C10-AL-01	150	
CZC	Código para pedido	Peso da ferramenta máx. recomendado, Kg	
C6	C6-AL-02	75	Mecanismo de trava ativo – ação mecânica de empuxe. Encaixa-se diretamente em todos os cassetes tipo 5000/6000.
C8	C8-AL-02	110	

B

C

D

E

F

G

H

Item de montagem

Ferramentas de extração para desmontagem do soquete poligonal nas unidades de fixação manual e automática

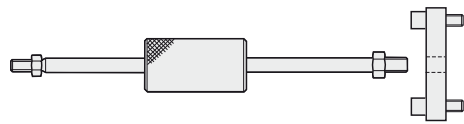

Ferramenta de extração

Ferramenta para extração

	Código para pedido
CZC	
C3	CC-ET-01
C4	CC-ET-01
C5	CC-ET-02
C6	CC-ET-02
C8	CC-ET-02

Nota: Ferramenta para extração deve ser pedida separadamente.

Use a ferramenta de remoção para remover a flange do polígono das unidades de fixação. Ela pode ser usada com a CC-ET-01/02.



	Código para pedido	Componentes	
CZC		Parafuso central	Parafuso periférico
C3	C3-WDT-01M	3214 030-463	5512 040-03
C4	C4-WDT-02	3214 030-464	5512 040-04
C5	C5-WDT-02	3214 030-516	5512 040-05
C6	C6-WDT-02	3214 030-516	5512 040-06
C8	C8-WDT-02	3214 030-516	3212 010-511

Plugue de proteção

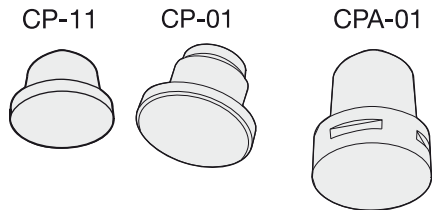

	Código para pedido		
CZC	Unidade manual	Unidade automática	Tipo 3000
C3	C3-CP-01	-	C3-CP-11
C4	C4-CP-01	C4-CPA-01	C4-CP-11
C5	C5-CP-01	C5-CPA-01	C5-CP-11
C6	C6-CP-01	C6-CPA-01	-
C8	C8-CP-01	C8-CPA-01	-
C10	-	C10-CPA-01	-

Unidade de pré-medição

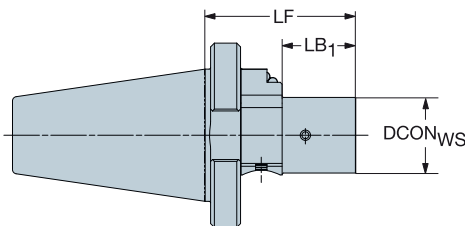

		Dimensões, mm							KG
CZC _{MS}	CZC _{WS}	Código para pedido	DCON _{WS}	LF	LB ₁	BD ₁	BD ₂		
50.0	C3	C3-PMU-150	32	75.0	36.0	32.0	97.5	3.02	
	C4	C4-PMU-150	40	80.0	39.0	40.0	97.5	3.21	
	C5	C5-PMU-150	50	90.0	45.0	50.0	97.5	3.60	
	C6	C6-PMU-150	63	107.0	56.0	63.0	97.5	4.42	
	C8	C8-PMU-150	80	127.0	60.0	80.0	97.5	5.80	

Item de montagem

Padrões de ajuste

Posição de verificação para garras do trocador

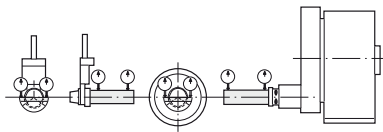

O sistema Coromant Capto garante precisão e repetibilidade excepcionais, porém é necessário que as outras peças, no processo total de usinagem, estejam posicionadas de modo correto e exato.

A Coromant oferece uma gama de padrões de ajuste axial e de altura de centro para os vários tamanhos de acoplamento, que são enfaticamente recomendados para ajuste de importantes parâmetros tais como:

Linha de centro da torre da ferramenta

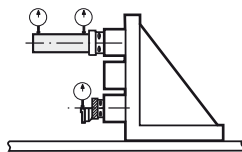

- A linha de centro da torre da ferramenta
- Orientação do fuso
- A posição da ferramenta para as garras do trocador
- A altura de centro da ferramenta e a posição da aresta de corte (f_1 e dimensões 1). Os padrões podem ser usados em um dispositivo de pré-medição
- Dispositivos da peça

Pré-ajuste da ferramenta

Controle geométrico do dispositivo da peça

Padrão axial

Padrões de ajuste MAS-11

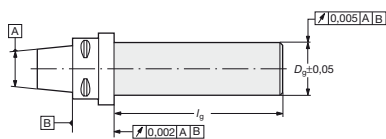

Tamanho do acoplamento	Código para pedido	Dimensões, mm	
		D_g	l_g
C3	C3-MAS-11	25	160
C4	C4-MAS-11	25	160
C5	C5-MAS-11	32	210
C6	C6-MAS-11	40	315
C8	C8-MAS-11	40	315
C10	C10-MAS-11	60	420

Padrão da altura de centro

Padrões de ajuste MAS-01

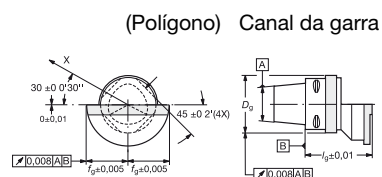

Tamanho do acoplamento	Código para pedido	Dimensões, mm		
		f_g	l_g	D_g
C3	C3-MAS-01	22	40	34
C4	C4-MAS-01	27	50	42
C5	C5-MAS-01	35	60	52
C6	C6-MAS-01	45	65	65
C8	C8-MAS-01	55	80	82
C10	C10-MAS-01	65	100	102

Padrão da altura de centro

Tamanho do acoplamento	Código para pedido	Dimensões, mm	
		l_g	D_g
C4	C4-MAS-25 140	140	25
C5	C5-MAS-32 145	145	32
C6	C6-MAS-40 180	180	40
C8	C8-MAS-40 240	240	40

Torquímetros

Coromant Capto®

Torquímetro para unidades de fixação manuais, troca rápida

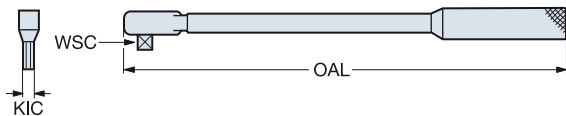

CZC	Torquímetro				Soquete		Unidade acionada	
	Código para pedido	Faixa de torque, Nm	WSC	OAL	Código para pedido	KIC	Código para pedido	KIC
C3	C-TK-01M	20-100	1/2"	400	5680 035-14	8	5680 035-17	5
C4	C-TK-01M	20-100	1/2"	400	5680 035-06	10	5680 035-14	8
C5	C-TK-01M	20-100	1/2"	400	5680 035-07	12	5680 035-06	10
C6	C-TK-01M	20-100	1/2"	400	5680 035-07	12	5680 035-07	12
C8	C-TK-02	40-200	1/2"	520	5680 035-07	12		
C10	C-TK-03	60-300	1/2"	620	5680 035-10	17		

Torquímetro para montagens modulares, fixação por parafuso central

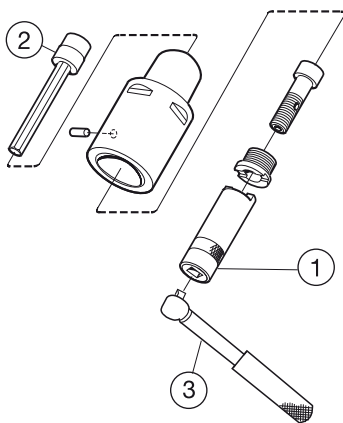

CZC	3. Torquímetro				2. Chave de extensão		1. Chave da porca de retenção	
	Código para pedido	Faixa de torque, Nm	WSC	OAL	Código para pedido	KIC	Código para pedido	KIC
C3	C-TK-02	40-200	1/2"	345	5680 015-05	8	5680 065-13	
C4	C-TK-02	40-200	1/2"	345	5680 015-05	8	5680 065-10	
C5	C-TK-02	40-200	1/2"	345	5680 015-01	10	5680 065-11	
C6	C-TK-02	40-200	1/2"	345	5680 015-02	14	5680 065-12	
C8	C-TK-02	40-200	1/2"	440	5680 015-02	14	5680 065-12	
C10	C-TK-04	80-400	3/4"	683	5680 015-06	17	5680 065-14	

Deve ser calibrado conforme a norma ISO 6789, precisão dentro de 4%

Torquímetros

Recomendações de torque

Valor de torque para Coromant Capto® :

Unidades de fixação manual tipos NC2000 e NC3000

CZC	Torque Nm
C3	35
C4	50
C5	70

Valor de torque para Coromant Capto® :

Unidades de fixação manual e porta-ferramentas acionados com mecanismo de came

CZC	Torque Nm
C3	35
C4	50
C5	70
C6	90
C8	130
C10	285

Coromant Capto® - pressão necessária:

Unidades de fixação hidromecânicas tipo 5000

CZC	Fixação Pressão, bar	Ejeção Pressão, bar
C4	100	100
C5	80	80
C6	80	80
C8	80	80
C10	80	80

Vazão de óleo necessária para todos os casos: 6 l/min

Suportes básicos Coromant Capto®

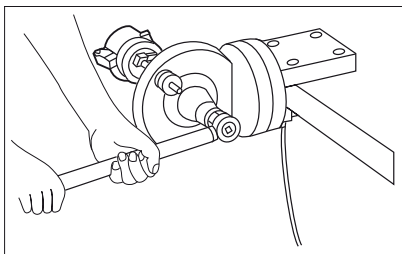

Fixação por parafuso central

CZC	Torque Nm
C3	45
C4	55
C5	95
C6	170
C8	170
C10	380

Ferramenta de ajuste da altura de centro

A nova ferramenta de ajuste pode ser usada para definir a altura de centro correta da aresta de corte para as barras de mandrilar CoroTurn® SL cilíndricas.

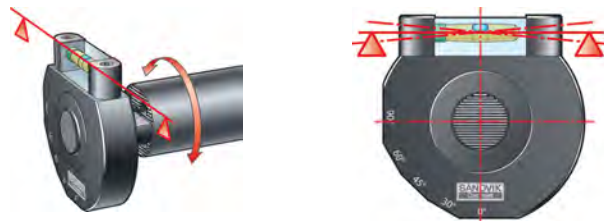

Acople à barra usando a aresta serrilhada.

Gire a barra para alcançar a altura de centro correta

C Procedimento para uso correto:

- Acople a ferramenta de ajuste à aresta serrilhada da barra de mandrilar cilíndrica
- Gire a barra de mandrilar até a posição certa
- Quando a bolha estiver na posição central, a barra fica paralela e está pronta para uso



Quando a bolha estiver na posição correta, a barra fica paralela.

D A ferramenta de ajuste de fácil uso oferece um método rápido e simples para a obtenção do ajuste correto das barras de mandrilar grandes, acima dos 25 mm (0.984 pol.) de diâmetro. Esta ferramenta de ajuste também pode ser usada para barras em máquinas multitarefas.

Código para pedido: SL-CHS-01

F Placa da capa



Acessórios (devem ser pedidos separadamente)

CZC _{WS}	Código para pedido
25	SL25-CP
32	SL32-CP
40	SL40-CP

Ferramentas para montagem

Informações de torque para adaptadores CoroTurn® SL



Tamanho	Bit	Tamanho da chaveta	Torquímetro	Valor de Torque Nm
16	5680 111-01	3/32"	5680 105-02	2.0 Nm
20	5680 111-01	7/64"	5680 105-02	2.8 Nm
25	5680 110-01	3mm	5680 105-05	3.7 Nm
32	5680 110-01	4mm	5680 105-06	8.8 Nm
40	5680 110-01	5mm	5680 099-01	17 Nm
70	5680 035-11	6mm	C-TK-01M	30 Nm

Bits hexagonais

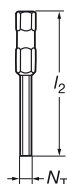

Bit	OAL		Caixa métrica	Caixa em polegadas
	mm	Polegadas	N _T mm	N _T Polegadas
5680 110-01	50	1.969	1.5, 2.0, 2.5, 3.0, 4.0, 5.0, 6.0	
5680 111-01	50	1.969		1/16", 5/64", 3/32", 7/64", 1/8", 9/64", 5/32", 3/16", 7/32", 1/4"

Ferramentas para montagem

Informação

Para obter melhor desempenho de nossas ferramentas, especialmente em cortes e canais, é muito importante ter o torque correto da pastilha.

No programa da Sandvik Coromant, há quatro torquímetros métricos que usam pontas para diferentes tamanhos Torx Plus disponíveis.

5680 105-01
5680 105-02
5680 105-03
5680 105-04



5680 105-05
5680 105-06
5680 105-07
5680 105-08



Torquímetro	Faixa de torque	
	Nm	Manipulo
5680 105-01	0.3 - 1.2	Reto
5680 105-02	1.2 - 3.0	Reto
5680 105-05	3.0 - 6.0	Angular
5680 105-06	4.0 - 8.8	Angular

Bit	OAL		NT
	mm	Torx Plus	
5680 084-01	50	8IP	
5680 084-02	50	15IP	
5680 084-03	89	15IP	
5680 084-04	50	7IP	
5680 084-05	50	9IP	
5680 084-06	50	10IP	
5680 084-07	50	20IP	
5680 084-08	89	20IP	
5680 084-09	89	25IP	
5680 084-10	89	30IP	
5680 084-11	50	6IP	
5680 084-12	80	27IP	
5680 084-13	35	50IP	

Bit	OAL		NT
	mm	Torx Plus	
5680 084-14	50	30IP	
5680 084-15	25	15IP	
5680 084-16	25	30IP	
5680 084-17	25	6IP	
5680 084-18	25	7IP	
5680 084-19	25	8IP	
5680 084-20	25	9IP	
5680 084-21	25	10IP	
5680 084-22	25	20IP	
5680 084-23	25	25IP	
5680 083-01	25	HEX3	
5680 083-04	50	HEX2,5	

Informações gerais

CoroTurn® SL

Sistema modular de adaptadores com cabeças de corte intercambiáveis

B

Aplicação

- Para torneamento, usinagem de canais e rosqueamento interno e externo
- É perfeito em combinação com as barras de mandril antivibratórias Silent Tools™ em operações com longos balanços ou tendência a vibrações
- C - Para todos os grupos de materiais

Características e benefícios

- A engenhosa interface Serration Lock (SL) é extremamente robusta e permite que você crie uma ampla gama de combinações de ferramentas com um estoque pequeno de adaptadores e cabeças de corte
- Adaptadores disponíveis para usinagem interna e externa
- Os olhais de alta precisão nas cabeças de corte fornecem a refrigeração exatamente onde ela é necessária para boa quebra de cavacos e vida útil mais longa da ferramenta
- O desgaste da ferramenta é concentrado principalmente na cabeça de corte intercambiável, aumentando a vida útil do adaptador
- Troca Rápida com Coromant Capto®
- Adaptadores com refrigeração interna para refrigeração eficiente



E O CoroTurn® SL está dividido em quatro sistemas diferentes:

F 1. Cabeças de corte, ferramentas convencionais e adaptadores



2. CoroTurn® SL70 para perfilamento e usinagem de bolsões



G 3. Troca rápida para diâmetros grandes



4. Troca rápida para diâmetros pequenos



Materiais de corte avançados

Em pastilhas com formato básico, negativas e positivas

Nitreto cúbico de boro (CBN)

A exclusiva gama de classes de CBN para torneamento de peças duras (HPT) com materiais desenvolvidos para alto desempenho na área de aplicação pretendida.



T-Max® P
 CoroTurn® 107
 CoroTurn® TR

Cerâmicas

A gama de classe de cerâmica inclui soluções para usinar ferros fundidos, super-ligas resistentes ao calor e materiais endurecidos.



T-Max®

Diamante policristalino (PCD)

Eficiente na usinagem de materiais não ferrosos.

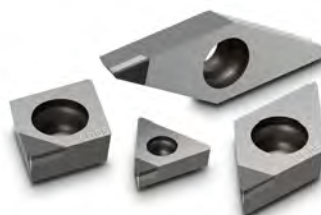

CoroTurn® 107
 T-Max®

Wiper

Pastilhas para maior produtividade

B

Para altas faixas de avanço sem afetar o acabamento superficial

Wiper

O desenho do raio de canto das pastilhas Wiper permite usinagem com faixas de avanço altas sem afetar o acabamento superficial ou a capacidade de quebrar cavacos.

- Duas vezes o avanço - mesmo acabamento superficial
- Mesmo avanço - acabamento superficial duas vezes melhor

TECHNOLOGY
Wiper

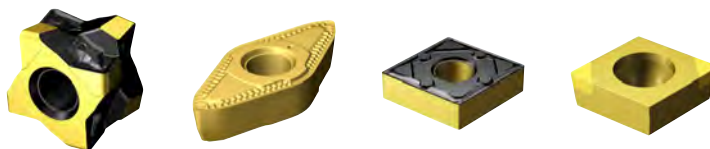

C

D

iLock™

Evitar o movimento da pastilha para melhor desempenho de usinagem

Aplicação

- Alta precisão dimensional
- Vida útil mais longa da ferramenta
- Bom controle de cavacos

As ferramentas com desenho iLock têm trilhos ou serrilhados no porta-ferramenta e canais correspondentes na pastilha para um travamento firme. Isso evita que as forças de corte afetem a posição da ferramenta.

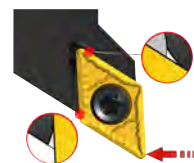

As forças de corte causam micromovimentos da pastilha em seu respectivo assento.

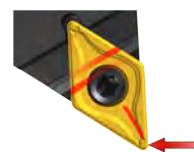

Com a interface tipo trilho em T no CoroTurn TR, a pastilha permanece fixa em sua posição.

G

H

CNSC

Código do tipo de entrada de refrigeração

Código	Descrição	Imagem
0	Sem refrigeração	
1	Entrada axial concêntrica	
2	Entrada radial	
3	Entrada axial concêntrica e radial	
4	Entrada axial concêntrica no círculo	
5	Entrada radial antes do adaptador	
6	Decentralizada sobre o flange	
7	Decentralizada sobre o flange e axial	
8	Decentralizada sobre canais na haste	

CXSC

Código do tipo de saída para refrigeração

Código	Descrição	Imagem
0	Sem saída de refrigeração	
1	Saída axial concêntrica	
2	Saída radial	
3	Saída inclinada axial	
4	Axial concêntrica no círculo	
5	Saída axial inclinada com olhal, ajustável	
6	Saída decentralizada com olhal, ajustável	
7	Decentralizada sobre canais na haste	
8	Axial ou decentralizada com olhal, ajustável	

Refrigeração de precisão

Suportes com olhais desenhados para refrigeração de alta precisão

Para controle de cavacos, segurança do processo e vida útil mais longa da ferramenta

Desenhados para pressão de refrigeração até 275 bar (4000 psi)



Os olhais de alta precisão fixos e pré-direcionados da Sandvik Coromant criam jatos laminares paralelos de refrigeração com alta velocidade, direcionados para o local exato da aresta da pastilha. As características e a precisão desses jatos fazem a diferença em termos de controle de cavacos e segurança do processo. Efeitos positivos começam a surgir sob baixa pressão de refrigeração, porém, com pressão mais alta, materiais mais difíceis podem ser usinados com sucesso.

Pastilhas para torneamento geral

C	N	M	G	12	04	08	-			-	PF
1	2	3	4	5	6	7		8	9		12

1 Formato da pastilha

C	D
K	R
S	T
V	W

2 Ângulo de folga da pastilha

B	C
E	N
P	O Descrição específica

3 Tolerâncias

Classe S	IC / W1	
G ±0.13	±0.025	
M ±0.13	±0.05 – ±0.15 ¹⁾	
U ±0.13	±0.08 – ±0.25 ¹⁾	
E ±0.025	±0.025	

¹⁾Varia de acordo com o tamanho do IC. Veja abaixo.

Círculo inscrito	Classe de tolerância	
IC mm	M	U
3.97		
5.0		
5.56		
6.0		
6.35	±0.05	±0.08
8.0		
9.525		
10.0		
12.0	±0.08	±0.13
12.7		
15.875		
16.0	±0.10	±0.18
19.05		
20.0		
25.0	±0.13	±0.25
25.4		
31.75	±0.15	±0.25
32.0		

Para pastilhas positivas iC é válido para um canto vivo. Veja as condições da aresta de corte F. (Figura 8).

4 Tipo de pastilha

A	Q
G	R
M	T
N	W
P	X
	Desenho especial

5 Tamanho da pastilha

C	D	R	S	T	V	W
06 09 12 16 19 25	06 07 11 13 15	05 08 09 10 12 15 16 19 20 25 31 32	09 12 15 19 25	05 06 11 16 22 27 33	11 13 16 22	02 04 06 08

Pastilhas para torneamento geral

6 Espessura da pastilha, S mm

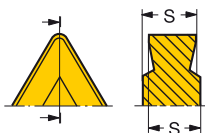

01	S = 1.59
T1	S = 1.98
02	S = 2.38
03	S = 3.18
T3	S = 3.97
04	S = 4.76
05	S = 5.56
06	S = 6.35
07	S = 7.94
09	S = 9.52
10	S = 10.00
12	S = 12.00

7 Raio de ponta, RE mm



00* = 0
01 = 0.1
02 = 0.2
04 = 0.4
05 = 0.5
08 = 0.8
10 = 1.0
12 = 1.2
15 = 1.5
16 = 1.6
24 = 2.4
32 = 3.2

8 Condições da aresta de corte

F	Aresta de corte viva
A	Aresta de corte com tratamento ER (ANSI)
E	Aresta de corte com tratamento ER
T	Fase negativa
K	Fases duplas negativas
S	Fase negativa e aresta de corte com tratamento ER

9 Versão da ferramenta

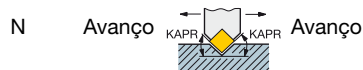
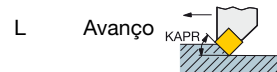

12 Opções do fabricante

O código ISO consiste de nove símbolos incluindo 8 e 9 que são usados apenas quando necessário. Além disso, o fabricante pode acrescentar mais três símbolos, por exemplo.

- WF = Wiper – acabamento
- WMX = Wiper, usinagem média
- PF = ISO P – acabamento
- PR = ISO P – desbaste
- HGR = Quebra-cavacos para remoção da camada endurecida

7 * Código de pastilhas redondas

Código 00 ou M0 na posição 7 é usado em pastilhas redondas no código métrico. M0 mostra que o diâmetro da pastilha tem uma dimensão métrica. No código imperial (polegadas), a posição 7 nunca é usada. É em branco.

A

Pastilhas para materiais de corte avançados

POR

B

C	N	G	A	12	04	08	T	010	20	R	A	WG
1	2	3	4	5	6	7	8	9	10	11	12	13

C

1 Formato da pastilha	
C	D
K	R
S	T
V	W

D

2 Ângulo de folga da pastilha	
B	C
E	N
P	O Descrição específica

E

3 Tolerâncias		
Classe S	IC / W1	
G ±0.13	±0.025	
M ±0.13	±0.05 – ±0.15 ¹⁾	
U ±0.13	±0.08 – ±0.25 ¹⁾	
E ±0.025	±0.025	
¹⁾ Varia de acordo com o tamanho do IC. Veja abaixo.		
Círculo inscrito IC mm	Classe de tolerância	
	M	U
3.97		
5.0		
5.56		
6.0	±0.05	±0.08
6.35		
8.0		
9.525		
10.0		
12.0	±0.08	±0.13
12.7		
15.875		
16.0	±0.10	±0.18
19.05		
20.0		
25.0	±0.13	±0.25
25.4		
31.75	±0.15	±0.25
32.0		
Para pastilhas positivas iC é válido para um canto vivo. Veja as condições da aresta de corte F. (Figura 8).		











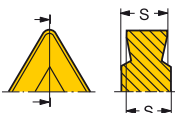





F

4 Tipo de pastilha	
A	Q
G	R
M	T
N	W
P	X
	Desenho especial

G

5 Tamanho da pastilha						
C	D	R	S	T	V	W
06 09 12 16 19 25	06 07 11 15	05 08 09 10 12 15 16 19 20 25 31 32	09 12 15 19 25	05 06 11 16 22 27 33	11 16 22	06 08

H

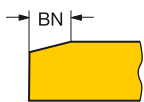
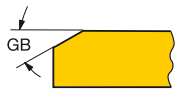
<p>6 Espessura da pastilha, S mm</p>  <table border="0"> <tr><td>01</td><td>s =</td><td>1.59</td></tr> <tr><td>T1</td><td>s =</td><td>1.98</td></tr> <tr><td>02</td><td>s =</td><td>2.38</td></tr> <tr><td>03</td><td>s =</td><td>3.18</td></tr> <tr><td>T3</td><td>s =</td><td>3.97</td></tr> <tr><td>04</td><td>s =</td><td>4.76</td></tr> <tr><td>05</td><td>s =</td><td>5.56</td></tr> <tr><td>06</td><td>s =</td><td>6.35</td></tr> <tr><td>07</td><td>s =</td><td>7.94</td></tr> <tr><td>09</td><td>s =</td><td>9.52</td></tr> <tr><td>10</td><td>s =</td><td>10.00</td></tr> <tr><td>12</td><td>s =</td><td>12.00</td></tr> </table>	01	s =	1.59	T1	s =	1.98	02	s =	2.38	03	s =	3.18	T3	s =	3.97	04	s =	4.76	05	s =	5.56	06	s =	6.35	07	s =	7.94	09	s =	9.52	10	s =	10.00	12	s =	12.00	<p>7 Raio de ponta, RE mm</p>  <table border="0"> <tr><td>00*</td><td>=</td><td>0</td></tr> <tr><td>01</td><td>=</td><td>0.1</td></tr> <tr><td>02</td><td>=</td><td>0.2</td></tr> <tr><td>04</td><td>=</td><td>0.4</td></tr> <tr><td>05</td><td>=</td><td>0.5</td></tr> <tr><td>08</td><td>=</td><td>0.8</td></tr> <tr><td>10</td><td>=</td><td>1.0</td></tr> <tr><td>12</td><td>=</td><td>1.2</td></tr> <tr><td>15</td><td>=</td><td>1.5</td></tr> <tr><td>16</td><td>=</td><td>1.6</td></tr> <tr><td>24</td><td>=</td><td>2.4</td></tr> <tr><td>32</td><td>=</td><td>3.2</td></tr> </table>	00*	=	0	01	=	0.1	02	=	0.2	04	=	0.4	05	=	0.5	08	=	0.8	10	=	1.0	12	=	1.2	15	=	1.5	16	=	1.6	24	=	2.4	32	=	3.2
01	s =	1.59																																																																							
T1	s =	1.98																																																																							
02	s =	2.38																																																																							
03	s =	3.18																																																																							
T3	s =	3.97																																																																							
04	s =	4.76																																																																							
05	s =	5.56																																																																							
06	s =	6.35																																																																							
07	s =	7.94																																																																							
09	s =	9.52																																																																							
10	s =	10.00																																																																							
12	s =	12.00																																																																							
00*	=	0																																																																							
01	=	0.1																																																																							
02	=	0.2																																																																							
04	=	0.4																																																																							
05	=	0.5																																																																							
08	=	0.8																																																																							
10	=	1.0																																																																							
12	=	1.2																																																																							
15	=	1.5																																																																							
16	=	1.6																																																																							
24	=	2.4																																																																							
32	=	3.2																																																																							
<p>8 Condições da aresta de corte</p> <table border="0"> <tr> <td>F</td> <td></td> <td>Aresta de corte viva</td> </tr> <tr> <td>E (A)</td> <td></td> <td>Aresta de corte com tratamento ER A (polegadas) E (métrica)</td> </tr> <tr> <td>T</td> <td></td> <td>Fase negativa</td> </tr> <tr> <td>K</td> <td></td> <td>Fases duplas negativas</td> </tr> <tr> <td>S</td> <td></td> <td>Fase negativa e aresta de corte com tratamento ER</td> </tr> </table>	F		Aresta de corte viva	E (A)		Aresta de corte com tratamento ER A (polegadas) E (métrica)	T		Fase negativa	K		Fases duplas negativas	S		Fase negativa e aresta de corte com tratamento ER	<p>12 Tipo de pastilha (CBN)</p> <p>Para permitir o atendimento de uma variedade de exigências de usinagem, vários tipos de pastilhas CBN e PCD foram fabricadas. Para fácil identificação dos diferentes tipos, a Sandvik Coromant usa uma letra para indicar as variantes.</p> <table border="0"> <tr> <td>A</td> <td>CBN, Pastilhas multiarestas - Totalmente intercambiável - CBN na parte superior a inferior dos cantos do corpo de metal duro</td> </tr> <tr> <td>B</td> <td>CBN, Pastilhas multiarestas - Totalmente intercambiável - CBN soldado nas partes superior e inferior dos cantos do corpo de metal duro.</td> </tr> <tr> <td>E</td> <td>CBN, Pastilhas com aresta única - Não intercambiáveis - CBN soldado na parte superior de um dos cantos do corpo de metal duro</td> </tr> <tr> <td>F</td> <td>CBN, Pastilhas multiarestas - Intercambiáveis - CBN soldado em cada canto do corpo de metal duro</td> </tr> <tr> <td>D</td> <td>CBN, Pastilhas com placa total de CBN - Intercambiáveis - CBN sinterizado na parte superior completa do corpo de metal duro</td> </tr> <tr> <td>M</td> <td>CBN, pastilhas sólidas - Totalmente intercambiável - Pastilha sólida de CBN</td> </tr> </table>	A	CBN, Pastilhas multiarestas - Totalmente intercambiável - CBN na parte superior a inferior dos cantos do corpo de metal duro	B	CBN, Pastilhas multiarestas - Totalmente intercambiável - CBN soldado nas partes superior e inferior dos cantos do corpo de metal duro.	E	CBN, Pastilhas com aresta única - Não intercambiáveis - CBN soldado na parte superior de um dos cantos do corpo de metal duro	F	CBN, Pastilhas multiarestas - Intercambiáveis - CBN soldado em cada canto do corpo de metal duro	D	CBN, Pastilhas com placa total de CBN - Intercambiáveis - CBN sinterizado na parte superior completa do corpo de metal duro	M	CBN, pastilhas sólidas - Totalmente intercambiável - Pastilha sólida de CBN																																													
F		Aresta de corte viva																																																																							
E (A)		Aresta de corte com tratamento ER A (polegadas) E (métrica)																																																																							
T		Fase negativa																																																																							
K		Fases duplas negativas																																																																							
S		Fase negativa e aresta de corte com tratamento ER																																																																							
A	CBN, Pastilhas multiarestas - Totalmente intercambiável - CBN na parte superior a inferior dos cantos do corpo de metal duro																																																																								
B	CBN, Pastilhas multiarestas - Totalmente intercambiável - CBN soldado nas partes superior e inferior dos cantos do corpo de metal duro.																																																																								
E	CBN, Pastilhas com aresta única - Não intercambiáveis - CBN soldado na parte superior de um dos cantos do corpo de metal duro																																																																								
F	CBN, Pastilhas multiarestas - Intercambiáveis - CBN soldado em cada canto do corpo de metal duro																																																																								
D	CBN, Pastilhas com placa total de CBN - Intercambiáveis - CBN sinterizado na parte superior completa do corpo de metal duro																																																																								
M	CBN, pastilhas sólidas - Totalmente intercambiável - Pastilha sólida de CBN																																																																								
<p>9 Largura do chanfro</p> <p>ISO mm</p> <table border="0"> <tr><td>010</td><td>BN =</td><td>0.10</td></tr> <tr><td>015</td><td>BN =</td><td>0.15</td></tr> <tr><td>020</td><td>BN =</td><td>0.20</td></tr> <tr><td>025</td><td>BN =</td><td>0.25</td></tr> <tr><td>070</td><td>BN =</td><td>0.70</td></tr> <tr><td>150</td><td>BN =</td><td>1.50</td></tr> <tr><td>200</td><td>BN =</td><td>2.00</td></tr> </table> 	010	BN =	0.10	015	BN =	0.15	020	BN =	0.20	025	BN =	0.25	070	BN =	0.70	150	BN =	1.50	200	BN =	2.00	<p>13 Geometria</p> <table border="0"> <tr> <td>HGR</td> <td>Quebra-cavacos para remoção de camada endurecida</td> </tr> <tr> <td>WG</td> <td>Geometria Wiper para usinagem geral Permite altas faixas de avanço em HPT Adequada para usinagem de acabamento de GCI</td> </tr> <tr> <td>WH</td> <td>Geometria Wiper otimizada para HPT Baixas forças de corte para acabamento superficial superior Desenhada para obter desempenho de pico nas faixas de avanço para acabamento HPT</td> </tr> <tr> <td>XA/XB</td> <td>Permite o uso de faixas de avanço mais altas que outras geometrias Wiper Mantém o acabamento superficial</td> </tr> </table>	HGR	Quebra-cavacos para remoção de camada endurecida	WG	Geometria Wiper para usinagem geral Permite altas faixas de avanço em HPT Adequada para usinagem de acabamento de GCI	WH	Geometria Wiper otimizada para HPT Baixas forças de corte para acabamento superficial superior Desenhada para obter desempenho de pico nas faixas de avanço para acabamento HPT	XA/XB	Permite o uso de faixas de avanço mais altas que outras geometrias Wiper Mantém o acabamento superficial																																											
010	BN =	0.10																																																																							
015	BN =	0.15																																																																							
020	BN =	0.20																																																																							
025	BN =	0.25																																																																							
070	BN =	0.70																																																																							
150	BN =	1.50																																																																							
200	BN =	2.00																																																																							
HGR	Quebra-cavacos para remoção de camada endurecida																																																																								
WG	Geometria Wiper para usinagem geral Permite altas faixas de avanço em HPT Adequada para usinagem de acabamento de GCI																																																																								
WH	Geometria Wiper otimizada para HPT Baixas forças de corte para acabamento superficial superior Desenhada para obter desempenho de pico nas faixas de avanço para acabamento HPT																																																																								
XA/XB	Permite o uso de faixas de avanço mais altas que outras geometrias Wiper Mantém o acabamento superficial																																																																								
<p>10 Angulo de chanfro, graus</p>  <table border="0"> <tr><td>15 GB =</td><td>15°</td><td>30 GB =</td><td>30°</td></tr> <tr><td>20 GB =</td><td>20°</td><td>35 GB =</td><td>35°</td></tr> <tr><td>25 GB =</td><td>25°</td><td></td><td></td></tr> </table>	15 GB =	15°	30 GB =	30°	20 GB =	20°	35 GB =	35°	25 GB =	25°			<p>11 Versão da pastilha</p> <p>Pastilhas desenhadas somente para usinagem na direção esquerda ou direita, conforme indicado abaixo.</p> <table border="0"> <tr> <td>R</td> <td>Desenho versão direita</td> </tr> <tr> <td>L</td> <td>Desenho versão esquerda</td> </tr> </table>	R	Desenho versão direita	L	Desenho versão esquerda																																																								
15 GB =	15°	30 GB =	30°																																																																						
20 GB =	20°	35 GB =	35°																																																																						
25 GB =	25°																																																																								
R	Desenho versão direita																																																																								
L	Desenho versão esquerda																																																																								

7 * Código de pastilhas redondas

Código 00 ou M0 na posição 7 é usado em pastilhas redondas no código métrico. M0 mostra que o diâmetro da pastilha tem uma dimensão métrica. No código imperial (polegadas), a posição 7 nunca é usada. É em branco.

Ferramentas convencionais e unidades de corte Coromant Capto®

Unidade de corte

C3	-	D	C	L	N	R	22	040	-	09	-	
1		2	3	4	5	6	9	10		11		12

Ferramenta convencional, métrica

D	C	L	N	R	25	25	M	12	-	2
2	3	4	5	6	7	8	10	11		13

1 Tamanho do acoplamento, mm

C = Coromant Capto®

DCON = tamanho do acoplamento

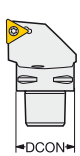

CZC _{MS}	DCON
C3	32
C4	40
C5	50
C6	63
C8	80

Coromant Capto®

2 Sistema de fixação





C Fixação por grampo	D Fixação Rígida (RC)	M, W Fixação por pino e grampo	P Fixação por alavanca	S Fixação por parafuso
------------------------------------	-------------------------------------	--	--------------------------------------	--------------------------------------

3 Formato da pastilha

C 	D
K 	R
S 	T
V 	W

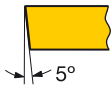
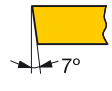
4 Tipo de suporte ângulo de posição (ângulo de ataque)

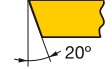
A 90° (0°) 	B 75° (15°) 	D 45° (45°) 	E 60° (30°) 	F 91° (-1°) 	G 91° (-1°) 	H 107.5° (-17.5°)
J 93° (-3°) 	K 75° (15°) 	L 95° (-5°) 	M 50° (40°) 	N 62.5° (27.5°) 	R 75° (15°) 	
S 45° (45°) 	T 60° (30°) 	U 93° (-3°) 	V 72.5° (17.5°) 	Y(X) 85° (5°) 	Y(Z) 85° (5°) 	

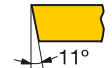
5 Ângulo de folga da pastilha	
B	 5°
C	 7°
D	 15°
E	 20°
N	 0°
P	 11°
O	Descrição específica

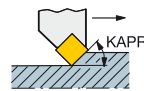
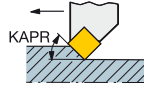
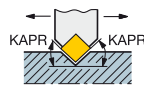

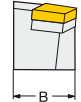

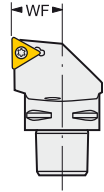

6 Versão da ferramenta	
R	 Avanço
L	 Avanço
N	 Avanço

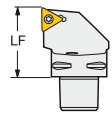
7 & 8 Tamanho da haste B, largura e H, altura	
7	<p>Altura da haste * Inteiros devem ser precedidos por 0, ex.: H = 8 mm indicado por 08</p> 
8	<p>Largura da haste * Inteiros devem ser precedidos por 0, ex.: B = 8 mm indicado por 08</p> 

9 Dimensão WF, Coromant Capto®	
	
Dimensão WF em mm (2 dígitos)	

10 Comprimento da ferramenta convencional	
	<p>A = 32 mm N = 150 mm B = 40 mm P = 170 mm C = 50 mm Q = 180 mm D = 60 mm R = 200 mm E = 70 mm S = 250 mm G = 80 mm T = 300 mm H = 100 mm U = 350 mm J = 110 mm V = 400 mm K = 125 mm W = 400 mm L = 140 mm M = 150 mm X = Especial</p>

10 Comprimento de ferramenta Coromant Capto®	
	Dimensão LF em mm (3 dígitos)

11 Tamanho da pastilha	
Comprimento da aresta de corte	
  	O comprimento da aresta de corte é indicado em mm.
  	Inteiro (sem arredondamentos).

12 Opções do fabricante	
Quando for necessário um símbolo suplementar, de no máximo 3 letras, pode ser acrescentado ao código ISO, separado por um traço, p. ex. W para desenho por cunha.	
13 Sistema de fixação para cerâmica	
-2 = Suportes CoroTurn® RC para pastilhas com furo	
-4 = Suportes CoroTurn® RC para pastilhas sem furo	

A

Barras de mandrilar

Barras de mandrilar Coromant Capto®

C3	-	S	C	L	C	R	-	11065	-	09	
1		5	6	7	8	9		13		10	11

B

Barras de mandrilar

S	40	V	-	S	C	L	C	R		12		-	ID
2	3	4		5	6	7	8	9		10		11	12

C

1 Tamanho do acoplamento

C = Coromant Capto®
 DCON = tamanho do acoplamento

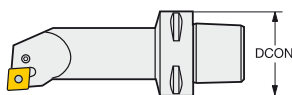

CZC _{MS}	DCON
C3	32
C4	40
C5	50
C6	63
C8	80

2 Tipo de barra

A = Barra de aço sólida com refrigeração interna.

E = Barra com haste de metal duro

F = Barra antivibratória com haste de metal duro

S = Barra de aço sólida sem refrigeração

3 Diâmetro da barra, mm

03
 04
 05
 06
 08
 10
 12
 16
 20
 24
 28
 32
 36
 40

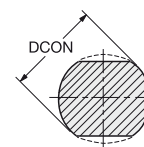

D

4 Comprimento da ferramenta, LF mm

Ferramenta convencional

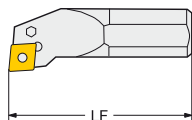

F = 80	S = 250
H = 100	T = 300
K = 125	U = 350
M = 150	V = 400
P = 170	W = 450
Q = 180	Y = 500
R = 200	X = Especial









5 Sistema de fixação









C	D	M,W	P	S
Fixação por grampo	Fixação Rígida (RC)	Fixação por pino e grampo	Fixação por alavanca	Fixação por parafuso





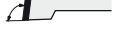

F

G



H

6 Formato da pastilha	
C 	D 
K 	R 
S 	T 
V 	W 

7 Tipo da barra, ângulo de posição (ângulo de ataque)	
F 91° (-1°) 	J 93° (-3°) 
K 75° (15°) 	L 95° (-5°) 
P 117.5° (-27.5°) 	Q 107.5° (-17.5°) 
U 93° (-3°) 	U-X 93° (-3°) 

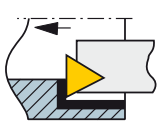
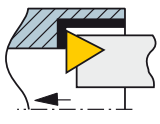
8 Ângulo de folga na aresta principal de corte	
B 	C 
D 	E 
N 	O Descrição específica
P 	

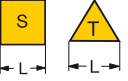
9 Versão da ferramenta
R 
L 

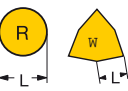
10 Comprimento da aresta de corte
Métrica
  

11 Opção do fabricante
Quando for necessário um símbolo suplementar, de no máximo 3 letras, pode ser acrescentado ao código ISO, separado por um traço, p. ex.
C = Recursos de refrigeração interna.
D = Dimensão WF estendida, + 1,0 mm (0,04")
E = Dimensão WF estendida, + 2,0 mm (0,08")
F = Dimensão WF estendida, + 3 mm (0,12")
G = Dimensões alteradas
L = Dimensão LF estendida
R = Haste redonda
W = Fixação por cunha
X = Mandrilamento reverso
B1 = Para pastilha com espessura de 03 = 3,18 mm.

12 Sistema de fixação Cerâmicas
ID = Grampo com placa de pressão

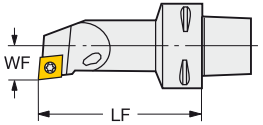
13 Tamanho da unidade de corte Coromant Capto, mm
WF x LF

Exemplo C4-SCLCR 11065-09 WF = 11 mm (2 dígitos) LF = 065 mm (3 dígitos)

CoroTurn® Prime

Chave de código para pastilhas



CP	-	A	11	08	-	M5	W	4325
1		2	3	4		5	6	7

1 Nome da família CoroTurn Prime

CP

4 Raio de ponta

04 = 0.4 mm

08 = 0.8 mm

6 W = Wiper (se disponível)

W

2 Tipo de pastilha

A = Variante para usinagem leve e perfilamento

B = Variante para usinagem em desbaste

5 Geometria da pastilha

L5 = Acabamento

M5 = Usinagem Média

7 Classe

4325

3 Tamanho da pastilha, IC

11 = 11 mm

Chave de código para suportes

Coromant Capto®



C4	-	CP	-	30	A	R	-	WF	LFx	-	11	C
1		2		3	4	5		6	7		8	9

Haste QS™



QS	-	CP	-	25	B	R	-	2020	-	11	B	
1		2		3	4	5		6		7	8	9

1 Tipo de conexão (e tamanho para Coromant Capto)

C4 = Capto, tamanho 4

QS = QS

5 Posicionamento da aresta de corte

R = versão direita

L = versão esquerda

7 Dimensão LFx Capto

LFx = Para dimensões Capto LF (3 dígitos)

2 Nome da família

6 Tamanho da haste

2020 = tamanho da haste HxB mm

8 Tamanho da pastilha, IC

11 = 11 mm

3 Ângulo de posição

25 = 25 graus, KAPR

30 = 30 graus, KAPR

6 Dimensão WF Capto

WF = para dimensões Capto WF (2 dígitos)

9 Tipo de refrigeração

A = Refrigeração de precisão (refrigeração superior)

B = Refrigeração de precisão (refrigeração inferior)

C = Refrigeração de precisão (Refrigeração superior e inferior)

Sem letra = Sem refrigeração

4 Tipo de pastilha

A = Variante para usinagem leve e perfilamento

B = Variante para usinagem em desbaste

CoroTurn® 300



Chave de código para pastilhas

3	-	80	-	10	11	08	-	8	-	L4
1		2		3	4	5		6		7

1 Nome da família CoroTurn 300

3

2 Ângulo de ponta das pastilhas

80 graus

3 Largura da pastilha

10 = 10 mm

4 Altura da pastilha

11 = 11 mm

5) Raio de ponta, RE

04 = 0.4 mm

08 = 0.8 mm

12 = 1,2 mm

6 Número de arestas

8

7 Geometria da pastilha

L4 = Acabamento

M5 = Usinagem Média

M5W = Wiper média

B

Chave de código para suportes

Coromant Capto®



C4	-	3	-	80	-	L	R	27	050	-	10	C
1		2		3		4	5	6	7		9	10

Haste QS™



QS	-	3	-	80	-	L	R	20	20	34	-	10	C
1		2		3		4	5	6	7	8		9	10

1 Tipo de conexão (e tamanho para Coromant Capto)

C4 = Capto, tamanho 4

QS = QS

2 Nome da família

3

3 Ângulo de ponta das pastilhas

80 graus

4 Ângulo de posição

L = 95 graus

5 Posicionamento da aresta de corte

R = versão direita

L = versão esquerda

N = neutra

6 Altura de haste

20 = 20 mm

6 Dimensão WF Capto

WF = Para dimensão Capto WF (2 dígitos, ex.: 27)

7 Largura da haste

20 = 20 mm

7 Dimensão LF Capto

LF = Para dimensão LF Capto (3 dígitos ex.: 050)

8 Comprimento funcional em mm

9 Largura da pastilha em mm

10 Tipo de refrigeração

A = Refrigeração de precisão (refrigeração superior)

B = Refrigeração de precisão (refrigeração inferior)

C = Refrigeração de precisão (Refrigeração superior e inferior)

Sem letra = Sem refrigeração

C

D

E

F

G

H

CoroTurn® TR

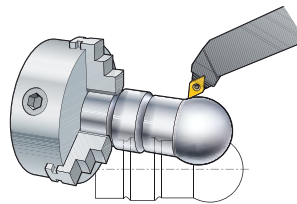
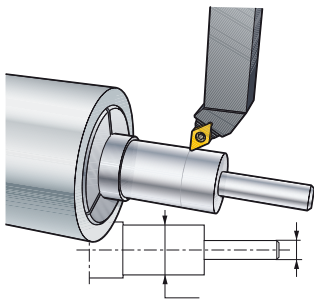

As operações de torneamento de perfis exigem muito da pastilha e do porta-ferramenta, devido às variações das forças. Isso pode causar problemas quanto à qualidade da peça na usinagem média ao acabamento.

Nessa área, o CoroTurn TR proporciona uma solução de desenho exclusiva, com uma interface de fixação inovadora, que possibilita um posicionamento altamente seguro e estável da pastilha no respectivo assento. Esse posicionamento firme melhora a qualidade e a produtividade nas operações de torneamento com pastilhas V (35°) e D (55°).

O novo desenho assegura que as exigências de qualidade sejam atendidas na usinagem externa e isso é bem apropriado para o torneamento de acabamento de perfis e usinagem média, em uma ampla gama de materiais.

Chave de código para pastilhas

TR	-	D	C	13	04	-	F
1		2	3	4	5		6

1 Nome da família CoroTurn TR

2 Formato da pastilha

D=55°, V=35°

3 Ângulo de folga da pastilha

C=7°, B=5°

Chave de código para suporte convencional

Métrica

TR	-	D	13	J	C	R	-	20	20	K
1		2	3	4	5	6		7	8	9

2 Formato da pastilha

D=55°, V=35°

3 Pastilha tamanho

4 Tipo de suporte, ângulo de posição

J=93°, N=63°

5 Ângulo de folga da pastilha

C=7°, B=5°

4 Tamanho da pastilha

Comprimento da aresta de corte, 13 mm

5) Raio de ponta, RE

04 = 0.4 mm

08 = 0.8 mm

12 = 1,2 mm

6 Tipo de suporte

R = versão direita

L = versão esquerda

N = neutra

7 Altura da haste, H mm

8 Largura da haste, B mm

9 Comprimento da haste, LF mm

K = 125 mm

M = 150 mm

P = 170 mm

2. Formato da pastilha

3/ 5. Ângulo de folga da pastilha

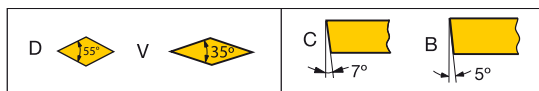

6 Geometria da pastilha

F = Acabamento

M = Usinagem média

Coromant Capto®

TR	-	C4	-	D	13	J	C	R	-	27	050
1		10		2	3	4	5	6		11	12



10 Tamanho do acoplamento Coromant Capto

11 Coromant Capto com dimensão WF em mm

12 comprimento da ferramenta Coromant Capto, mm

Pastilhas CoroCut® 1-2-3 arestas



N	123	H	2	-	0400	-	00	04	-	TF
1	2	3	4		5		6	7		8

1 Versão da pastilha	2 Código principal	3 Tamanho do assento
R 	123	CoroCut® 1-2 D G K E H L F J M R CoroCut® 3 T = versão direita U = versão esquerda Para corresponder com o tamanho do assento no suporte.
N 		
L 		

Intercambialidade do assento da pastilha:

Tamanho do assento da pastilha	Tamanho, mm	Suporte	Tamanho do assento da pastilha	Tamanho, mm	Suporte
D	1.5	D	H	4.0	H
E	2.0	E	J	5.0	J, H
F	2.5	F, E	K	6.0	K, J, H
G	3.0	G, F, E	L	8.0	L
			M	9.0	M
			R	15.0	R

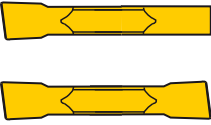
4 Número de arestas

1 ou 2 	3 
---	--

5 Largura da pastilha

P. ex.: 0400 = 4.0 mm 
--

6 Ângulo frontal

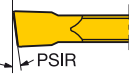
P. ex.: 00 = 0° 05 = 5° 

7 Raio de canto

P. ex.: 04 = 0.4 mm 08 = 0.8 mm 

8 Designação da geometria

Primeiro dígito: Tipo de operação A = Alumínio/perfilamento C = Corte T = Torneamento G = Canais R = Perfilamento B = Blank	Segundo dígito: E = Aresta de corte com tratamento ER F = Baixo avanço M = Médio avanço R = Alto avanço O = Otimizado para áreas especiais S = Aresta de corte viva G = Blank
---	--

Ferramentas CoroCut® 1-2-3 arestas

Coromant Capto®





C4	-	R	F	123	E	15	-	27055	B
1		2	3	4	5	6		7	8

Suporte convencional



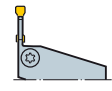
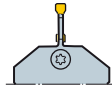
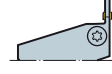





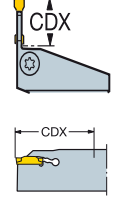
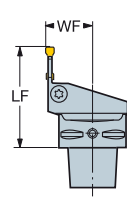
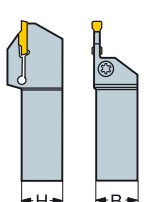
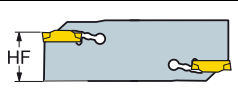
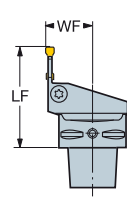
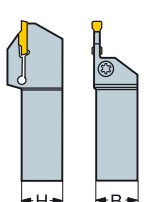
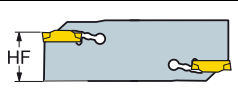
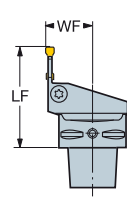
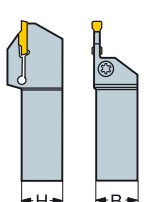
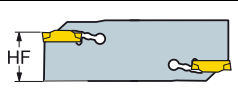

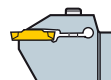
R	F	123	E	08	-	1616	B	-	007	064	B
2	3	4	5	6		7	8		10	12	13

Lâmina

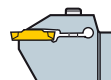
N	123	F	55	-	25	A	2
2	4	5	6		7	8	9

<p>1 Tamanho do acoplamento</p> <p>C = Coromant Capto® DCON = tamanho do acoplamento</p> <table border="1"> <tr> <td></td> <td>DCON</td> <td>mm</td> </tr> <tr> <td>C3</td> <td>32</td> <td></td> </tr> <tr> <td>C4</td> <td>40</td> <td></td> </tr> <tr> <td>C5</td> <td>50</td> <td></td> </tr> <tr> <td>C6</td> <td>63</td> <td></td> </tr> <tr> <td>C8</td> <td>80</td> <td></td> </tr> </table> 		DCON	mm	C3	32		C4	40		C5	50		C6	63		C8	80		<p>2 Versão da ferramenta</p> <p>R </p> <p>N </p> <p>L </p>	<p>3 Tipo de suporte</p> <p>F  0°</p> <p>G  90°</p> <p>X  1-70°</p> <p>4 Código principal</p> <p>123</p>
	DCON	mm																		
C3	32																			
C4	40																			
C5	50																			
C6	63																			
C8	80																			

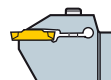
<p>5 Tamanho do assento da pastilha</p> <p>CoroCut® 1-2</p> <table border="1"> <tr> <td>D</td> <td>G</td> <td>K</td> </tr> <tr> <td>E</td> <td>H</td> <td>L</td> </tr> <tr> <td>F</td> <td>J</td> <td>M</td> </tr> <tr> <td></td> <td></td> <td>R</td> </tr> </table> <p>CoroCut® 3</p> <p>T = Corte versão direita</p> <p>U = Corte versão esquerda</p> <p>Para corresponder com o tamanho do assento na pastilha.</p>	D	G	K	E	H	L	F	J	M			R	<p>6 Limitações de usinagem</p>  <p>Profundidade de corte máxima, CDX em mm</p> <p>08 = 8 mm</p>	<p>7 Dimensão da unidade de corte/haste</p> <table border="1"> <tr> <td>Coromant Capto®</td> <td>Ferramenta convencional</td> </tr> <tr> <td></td> <td></td> </tr> <tr> <td>Por exemplo: WF 27 mm LF 55 mm</td> <td>Números inteiros devem ser precedidos por zero, p. ex., b = 8 mm é indicado por 08 H B 16 16</td> </tr> <tr> <td colspan="2"></td> </tr> <tr> <td colspan="2">Lâmina Dimensões em mm.</td> </tr> </table>	Coromant Capto®	Ferramenta convencional			Por exemplo: WF 27 mm LF 55 mm	Números inteiros devem ser precedidos por zero, p. ex., b = 8 mm é indicado por 08 H B 16 16			Lâmina Dimensões em mm.	
D	G	K																						
E	H	L																						
F	J	M																						
		R																						
Coromant Capto®	Ferramenta convencional																							
																								
Por exemplo: WF 27 mm LF 55 mm	Números inteiros devem ser precedidos por zero, p. ex., b = 8 mm é indicado por 08 H B 16 16																							
																								
Lâmina Dimensões em mm.																								

<p>8 Sistema de fixação</p> <table border="1"> <tr> <td>A Fixação por mola </td> <td>B Fixação por parafuso </td> <td>C Canais rasos </td> <td>D Fixação por parafuso reforçada </td> </tr> </table>	A Fixação por mola 	B Fixação por parafuso 	C Canais rasos 	D Fixação por parafuso reforçada 	<p>9 Número de assentos da pastilha</p> <p>1 = Assento de uma pastilha</p> <p>2 = Assentos de duas pastilhas</p>	<p>10 Ângulo do suporte</p> <p>007 = 7°</p> <p>045 = 45°</p> <p>070 = 70°</p> <p>Válido para suporte tipo = X</p>
A Fixação por mola 	B Fixação por parafuso 	C Canais rasos 	D Fixação por parafuso reforçada 			

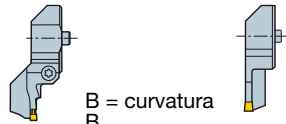
<p>11 Aplicação especial</p> <p>S = Suporte para usinagem de peças pequenas</p>	<p>12 Diâmetro mín. para primeiro corte, para canais frontais</p> <p>Diâmetro mín. para primeiro corte em mm.</p>	<p>13 Tipo de curvatura, para canais frontais</p>  <p>B = curvatura</p> <p>A = curvatura</p>
--	--	--

Pastilha CoroCut® QD para corte

Q	D	-	N	G	-	0300	00	02	-	CM
1	2		3	4		5	6	7		8

1 Sistema	2 Aplicação	3 Versão da pastilha
Q = CoroCut® QD	D = Cortes e canais profundos	N/R/L N = neutra R = versão direita L = versão esquerda

4 Tamanho do assento																								
<table> <tr> <td>Tamanho do assento da pastilha</td> <td>Tamanho do assento do suporte</td> </tr> <tr> <td>SSC mm</td> <td>SSC</td> </tr> <tr> <td>B 1.00 - 1.19</td> <td>B</td> </tr> <tr> <td>C 1.20 - 1.49</td> <td>C (B)</td> </tr> <tr> <td>D 1.50 - 1.99</td> <td>D</td> </tr> <tr> <td>E 2.00 - 2.30</td> <td>E</td> </tr> <tr> <td>F 2.31 - 2.99</td> <td>F (E)</td> </tr> <tr> <td>G 3.00 - 3.99</td> <td>G (F, E)</td> </tr> <tr> <td>H 4.00 - 4.99</td> <td>H</td> </tr> <tr> <td>J 5.00 - 5.99</td> <td>J</td> </tr> <tr> <td>K 6.00 - 7.80</td> <td>K (J)</td> </tr> <tr> <td>L 7.81 - 8.99</td> <td>L</td> </tr> </table>	Tamanho do assento da pastilha	Tamanho do assento do suporte	SSC mm	SSC	B 1.00 - 1.19	B	C 1.20 - 1.49	C (B)	D 1.50 - 1.99	D	E 2.00 - 2.30	E	F 2.31 - 2.99	F (E)	G 3.00 - 3.99	G (F, E)	H 4.00 - 4.99	H	J 5.00 - 5.99	J	K 6.00 - 7.80	K (J)	L 7.81 - 8.99	L
Tamanho do assento da pastilha	Tamanho do assento do suporte																							
SSC mm	SSC																							
B 1.00 - 1.19	B																							
C 1.20 - 1.49	C (B)																							
D 1.50 - 1.99	D																							
E 2.00 - 2.30	E																							
F 2.31 - 2.99	F (E)																							
G 3.00 - 3.99	G (F, E)																							
H 4.00 - 4.99	H																							
J 5.00 - 5.99	J																							
K 6.00 - 7.80	K (J)																							
L 7.81 - 8.99	L																							

5 Largura da pastilha	6 Ângulo frontal da pastilha	7 Raio do canto da pastilha
CW 0400 = 4 mm	PSIRL, PSIRR P. ex.: 00 = 0°	RE 04 = 0.40 mm

8 Geometria da pastilha														
<table> <tr> <td>Primeira letra</td> <td>Segunda letra</td> </tr> <tr> <td>C = Corte</td> <td>F = Baixo avanço</td> </tr> <tr> <td>T = Torneamento</td> <td>M = Médio avanço</td> </tr> <tr> <td>B = Blank</td> <td>R = Alto avanço</td> </tr> <tr> <td>G = Canais</td> <td>O = Otimizador</td> </tr> <tr> <td></td> <td>L = Baixo-carbono</td> </tr> <tr> <td></td> <td>G = Blank</td> </tr> </table>	Primeira letra	Segunda letra	C = Corte	F = Baixo avanço	T = Torneamento	M = Médio avanço	B = Blank	R = Alto avanço	G = Canais	O = Otimizador		L = Baixo-carbono		G = Blank
Primeira letra	Segunda letra													
C = Corte	F = Baixo avanço													
T = Torneamento	M = Médio avanço													
B = Blank	R = Alto avanço													
G = Canais	O = Otimizador													
	L = Baixo-carbono													
	G = Blank													

Lâmina CoroCut® QD para cortes

Q D - N N 2 G 60 C 25 A

1 2 3 4 5 6 7 8 9 10

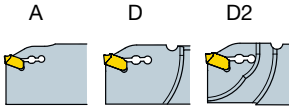
<p>1 Sistema</p> <p>Q = CoroCut® QD</p>	<p>2 Aplicação</p> <p>D = Cortes e canais profundos</p>	<p>3 Versão do acoplamento da ferramenta</p> <p>N R L</p>  <p>N = neutra, R = versão direita, L = versão esquerda</p>																								
<p>4 Versão da ferramenta - lado da pastilha</p> <p>N/R/L N = neutra R = versão direita L = versão esquerda</p>	<p>5 Número de assentos da pastilha</p> <p>1 = Uma pastilha 2 = Duas pastilhas</p>	<p>6 Tamanho do assento</p> <table border="1"> <thead> <tr> <th>Tamanho do assento da pastilha</th> <th>Tamanho do assento do suporte</th> </tr> </thead> <tbody> <tr> <td>SSC</td> <td>SSC</td> </tr> <tr> <td>B</td> <td>B</td> </tr> <tr> <td>C</td> <td>C (B)</td> </tr> <tr> <td>D</td> <td>D</td> </tr> <tr> <td>E</td> <td>E</td> </tr> <tr> <td>F</td> <td>F (E)</td> </tr> <tr> <td>G</td> <td>G (F, E)</td> </tr> <tr> <td>H</td> <td>H</td> </tr> <tr> <td>J</td> <td>J</td> </tr> <tr> <td>K</td> <td>K (J)</td> </tr> <tr> <td>L</td> <td>L</td> </tr> </tbody> </table>	Tamanho do assento da pastilha	Tamanho do assento do suporte	SSC	SSC	B	B	C	C (B)	D	D	E	E	F	F (E)	G	G (F, E)	H	H	J	J	K	K (J)	L	L
Tamanho do assento da pastilha	Tamanho do assento do suporte																									
SSC	SSC																									
B	B																									
C	C (B)																									
D	D																									
E	E																									
F	F (E)																									
G	G (F, E)																									
H	H																									
J	J																									
K	K (J)																									
L	L																									
<p>7 Profundidade de corte da ferramenta</p> <p>Profundidade de corte máx., CDX</p> <p>60 = 60 mm</p>	<p>8 Refrigeração interna</p> <p>C = Com refrigeração - = Sem refrigeração</p>																									
<p>9 Altura da lâmina</p> <p>Altura da aresta de corte, mm</p>	<p>10 Extremidade frontal</p> <p>A = Sem ou reforço reto D = 1 curva de reforço D2 = 2 curvas de reforço</p> 																									

Ferramenta convencional CoroCut® QD e QS para cortes e canais

QS - Q D - R F G 26 C 2525 D
1 2 3 4 5 6 7 8 9 10

1 Acoplamento SL QS Coromant Capto® C3-C8	2 Sistema Q = CoroCut® QD	3 Aplicação D = Cortes e canais profundos
---	---	---

4 Versão da ferramenta N/R/L N = neutra, R = versão direita, L = versão esquerda	5 Tipo de suporte F = 0° G = 90° X = Outros	6 Tamanho do assento <table style="width: 100%; border-collapse: collapse;"> <thead> <tr> <th style="text-align: left;">Tamanho do assento do suporte</th> <th style="text-align: center;">Tamanho mm</th> <th style="text-align: left;">Tamanho do assento da pastilha</th> </tr> </thead> <tbody> <tr> <td>SSC</td> <td></td> <td>SSC</td> </tr> <tr> <td>B</td> <td style="text-align: center;">1.00 - 1.19</td> <td>B</td> </tr> <tr> <td>C (B)</td> <td style="text-align: center;">1.20 - 1.49</td> <td>C</td> </tr> <tr> <td>D</td> <td style="text-align: center;">1.50 - 1.99</td> <td>D</td> </tr> <tr> <td>E</td> <td style="text-align: center;">2.00 - 2.30</td> <td>E</td> </tr> <tr> <td>F (E)</td> <td style="text-align: center;">2.31 - 2.99</td> <td>F</td> </tr> <tr> <td>G (F, E)</td> <td style="text-align: center;">3.00 - 3.99</td> <td>G</td> </tr> <tr> <td>H</td> <td style="text-align: center;">4.00 - 4.99</td> <td>H</td> </tr> <tr> <td>J</td> <td style="text-align: center;">5.00 - 5.99</td> <td>J</td> </tr> <tr> <td>K (J)</td> <td style="text-align: center;">6.00 - 7.80</td> <td>K</td> </tr> <tr> <td>L</td> <td style="text-align: center;">7.81 - 8.99</td> <td>L</td> </tr> </tbody> </table>	Tamanho do assento do suporte	Tamanho mm	Tamanho do assento da pastilha	SSC		SSC	B	1.00 - 1.19	B	C (B)	1.20 - 1.49	C	D	1.50 - 1.99	D	E	2.00 - 2.30	E	F (E)	2.31 - 2.99	F	G (F, E)	3.00 - 3.99	G	H	4.00 - 4.99	H	J	5.00 - 5.99	J	K (J)	6.00 - 7.80	K	L	7.81 - 8.99	L
Tamanho do assento do suporte	Tamanho mm	Tamanho do assento da pastilha																																				
SSC		SSC																																				
B	1.00 - 1.19	B																																				
C (B)	1.20 - 1.49	C																																				
D	1.50 - 1.99	D																																				
E	2.00 - 2.30	E																																				
F (E)	2.31 - 2.99	F																																				
G (F, E)	3.00 - 3.99	G																																				
H	4.00 - 4.99	H																																				
J	5.00 - 5.99	J																																				
K (J)	6.00 - 7.80	K																																				
L	7.81 - 8.99	L																																				

7 Profundidade de corte da ferramenta Profundidade de corte máx., CDX 60 = 60 mm	8 Refrigeração interna C = Com refrigeração - = Sem refrigeração	
---	---	--

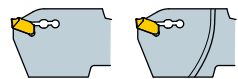
9 Tamanho/diâm. da haste ou acoplamento <table style="width: 100%;"> <tr> <td style="width: 30%;">Haste</td> <td>4 dígitos</td> </tr> <tr> <td>QS</td> <td>4 dígitos</td> </tr> <tr> <td>SL</td> <td>2 dígitos</td> </tr> </table>	Haste	4 dígitos	QS	4 dígitos	SL	2 dígitos	10 Extremidade frontal (reforço) S = Pequena A = Sem reforço D = Curva reforçada Desenhado para máquinas com cabeçote móvel 
Haste	4 dígitos						
QS	4 dígitos						
SL	2 dígitos						

CoroTurn® XS

Ferramentas de corte para torneamento

CXS	04	T	098	A	10	-	22	06	R
1	2	3	4	13	5		9	10	12

Ferramentas de corte para usinagem de canais

CXS	06	F	100	-	62	15	A	R
1	2	3	6		9	10	11	12

Ferramentas de corte para rosqueamento

CXS	04	TH	050	VM	-	42	15	R
1	2	3	7	8		9	10	12

1 Código principal

CXS = CoroTurn® XS

2 Tamanho da pastilha mm



04 = 4 mm
05 = 5 mm
06 = 6 mm
07 = 7 mm

3 Tipo de operação

T = Torneamento
TE = Torneamento em cópia, dimensão f_1 expandida
F = Canais frontais
G = Canais
GX = Pré-corte
R = Raio completo para perfilamento
TH = Rosqueamento
B = Mandrilamento reverso

4 Ângulo de posição (Torneamento)

Ângulo de posição 98°
Ângulo de ataque -8°

5 Raio de ponta, RE mm (Torneamento)



P. ex.:
10 = 0,1 mm
15 = 0,15 mm
20 = 0,2 mm

6 Largura da pastilha, CW mm (Canais)



P.ex.: 100 = 1.00 mm

7 Passo, mm (Rosqueamento)

mm: passo x 100

8 Perfil da rosca (Rosqueamento)

VM = Perfil V 60°
WH = Whitworth 55°
NT = NPT 60°
UN = UN 60°
MM = MM 60°
TR = Trapezoidal 30°

9 Diâmetro mínimo do furo, DMIN.

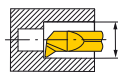

furo mínimo

P.ex.: 22 = 2.2 mm

10 Profundidade de penetração, LU

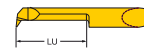

P. ex.: 06 = 6 mm

11 Tipo de curva (Canais frontais)

A = curvatura A

13 Geometria

- = Sem geometria formadora de cavacos
A = Geometria formadora de cavacos

12 Versão da pastilha

R = Versão direita
L = Versão esquerda

CoroTurn® XS

Barras de mandrilar

CXS	A	10	-	04
1	2	3		4

Barras de mandrilar com dupla extremidade



C4	-	CXS	-	47	-	04
8		1		9		4

Ferramenta convencional

CXS	-	1010	-	04	F	N
1		6		4	10	7

Suporte Coromant Capto®

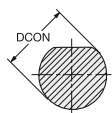
CXS	A	10	-	04	-	04
1	2	3		4		5

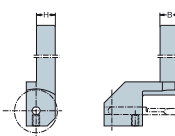
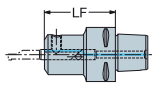
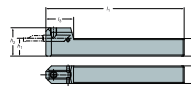
<p>1 Código principal</p> <p>CXS = CoroTurn® XS</p>	<p>2 Tipo de barra</p> <p>A = Barra de aço com refrigeração interna</p>	<p>3 Diâmetro da barra, DCON</p>  <p>10 = 10 mm</p>
<p>4 Tamanho da pastilha</p>  <p>04 = 4 mm 05 = 5 mm 06 = 6 mm 07 = 7 mm</p>	<p>5 Tamanho da pastilha para subfuso</p> <p>Para barras de mandrilar com dupla extremidade, mesmo que 4.</p>	<p>6 Tamanho da haste (largura e altura), mm</p>  <p>H = 10 mm B = 10 mm</p>
<p>7 Versão da ferramenta</p> <p>L = Versão esquerda R = Versão direita N = neutra</p>	<p>9 Comprimento Coromant Capto®</p> <p>LF = 47 mm</p> 	<p>10 Tipo de haste</p> <p>F = 0°</p> 
<p>8 Tamanho Coromant Capto®</p> <p>C3 DCON = 32 mm C4 DCON = 40 mm C5 DCON = 50 mm C6 DCON = 63 mm</p>		

CoroCut® XS

Pastilha para cortes

M	A	C	R	3	070	-	N
1	2	3	4	5	6		7

Pastilha para torneamento/canais





M	A	G	R	3	125
1	2	3	4	5	6

Pastilha para rosqueamento

M	A	T	R	3	60	-	A
1	2	3	4	5	8		9

Suporte convencional

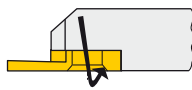
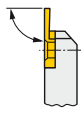
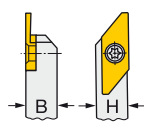
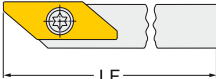
S	M	A	L	R	1010	K	3	-	X
10	1	11	4	12	13	5			14

<p>1 Descrição da família</p> <p>M = </p>	<p>2 Ângulo de folga da pastilha</p> <p>A = 50° </p>	<p>3 Tipo de operação</p> <p>C = Corte G = Canais T = Rosqueamento F = Torneamento B = Torneamento reverso X = Blanks para semiacabamento</p>
<p>4 Versão da pastilha/suporte</p> <p>R = Versão direita L = Versão esquerda</p>	<p>5 Tamanho do assento da pastilha</p> <p>3</p>	<p>6 Espessura/raio de canto da pastilha, mm</p> <p>Para pastilha de corte com largura (CW) 070 = 0,70 mm</p> <p>Para torneamento reverso, pastilha com raio de canto (RE) 005 = 0,05 mm</p>
<p>7 Para pastilhas de corte (C na terceira posição)</p> <p>N = Versão neutra com geometria T = Versão neutra com geometria L = Versão esquerda com geometria R = Versão direita com geometria</p>	<p>8 Para pastilhas de rosqueamento (T na terceira posição)</p> <p>60 = perfil V 60°</p>	<p>9 Para pastilhas de rosqueamento Versão da rosca</p> <p>N = Neutra A = Versão direita C = Versão esquerda</p>
<p>10 Sistema de fixação</p> <p>S = Fixação por parafuso </p>	<p>11 Tipo de suporte</p> <p>AL = 90° </p>	<p>12 Dimensões da haste</p> <p>ex. 1010 = 10 x 10 </p>
<p>13 Comprimento da haste da ferramenta, mm</p> <p>K : LF = 125 mm </p>	<p>14 Informações adicionais</p> <p>X = Desenhado especialmente para trabalhos com "sub-spindle" </p>	

CoroCut® MBPastilha para torneamento/
Mandrillamento reverso

MB	-	07	T	093	A	-	02	-	10	R
1		2	3	4	16		5		9	12

Pastilha para canais/pré-corte

MB	-	07	G	070	-	00	-	10	R
1		2	3	6		5		9	12

Pastilha para rosqueamento

MB	-	07	TH	050	VM	-	10	R
1		2	3	7	8		9	12

Barras de mandrilar

MB	-	A	16	-	16	-	07	R
1		13	14		10		2	15

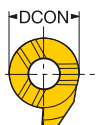
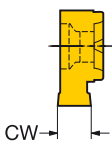
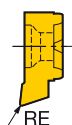
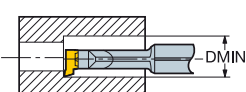
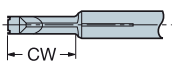
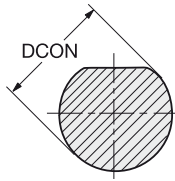
1 Código principal MB = CoroCut® MB	2 Tamanho da pastilha, mm  07 = 7 mm 09 = 9 mm	3 Tipo de operação B = Mandrilamento reverso G = Canais GX = Pré-corte R = Raio completo para perfilamento T = Torneamento TE = Torneamento em cópia, dimensão f_1 expandida TH = Rosqueamento FA = Canal frontal curvatura-A FB = Canal frontal curvatura-B
4 Ângulo de posição (Torneamento) P. ex.: 093 = 93°	6 Largura da pastilha, CW mm (Canais)  P. ex.: 100 = 1.00 mm	7 Passo (Rosqueamento) mm: passo x 100
5 Raio de ponta, RE mm (Torneamento)  P. ex.: 00 = Viva 02 = 0.2 mm	9 Diâmetro mínimo do furo, DMIN (Pastilha)  P. ex.: 10 = 10 mm	10 Profundidade de penetração, CW (barra de mandrilar)  P. ex.: 16 = 16 mm
8 Perfil da rosca (Rosqueamento) VM = Perfil V 60° MM = Métrica 60° WH = Withworth 55° UN = UN 60° NT = NPT 60° AC = ACME 29° SA = STUB-ACME	14 Diâm. da barra, DCON  P. ex.: 16 = 16 mm	15 Tipo de haste R = Cilíndrica Sem símbolo = Com planos
13 Tipo de barra A = Barra de aço com refrigeração interna E = Barra com haste de metal duro	16 Geometria - = Sem geometria formadora de cavacos A = Geometria formadora de cavacos	

A

CoroThread® 266

B

Pastilha para rosqueamento

266	R	G	-	22	TR0	1	F	600		E	
1	2	3		4	5	6	7	8	9	10	11

C

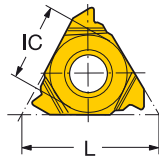
1 Código principal	2 Versão da ferramenta	3 Tipo de usinagem	4 Dimensão/tamanho da pastilha
266 = CoroThread® 266	R = Versão direita L = Versão esquerda	G = pastilhas para rosqueamento externo L = pastilhas para rosqueamento interno	16 = <i>iC</i> 9.52 mm 22 = <i>iC</i> 12.70 mm 27 = <i>iC</i> 15.88 mm 

D

5 Perfil da rosca	6 Quantidade de cortes por aresta
VM0 = Perfil V 60° VW0 = Perfil V 55* MM0 = Métrica 60° UN0 = UN 60° WH0 = Whitworth 55° NT0 = NPT 60° RN0 = Redonda 30° PT0 = BSPT 55° TR0 = Trapezoidal 30° AB0 = Buttress 45°-7° AC0 = ACME 29° SA0 = STUB-ACME 29° NJ0 = UNJ 60° MJ0 = MJ 60° NF0 = NPTF 60° BU0 = Buttress RD0 = API Rd 60° V38 = V-0.038R V40 = V-0.040 V50 = V-0.050	Varia de 1 a 3 cortes. 1 = 1 corte 2 = 2 cortes 3 = 3 cortes

E

7 Condições da aresta de corte	8 Passo	9 Código suplementar
A = Aresta arredondada (ER) F = Aresta de corte viva C = Geometria formadora de cavacos	mm: passo x 100	Conicidade no diâmetro/polegadas por pé (i.p.f.) 1 = 1 i.p.f. 2 = 2 i.p.f. 3 = 3 i.p.f.

F

10 Tolerância da posição da aresta de corte
M = ± 0,05 mm axial E = ± 0,01 mm axial

G



1) Gravação:
Todas as pastilhas estão identificadas com o perfil, classe e passo: as pastilhas internas são identificadas com um círculo. Para evitar que a identificação seja apagada, a mesma é aplicada a laser na lateral da pastilha.

11 Pastilhas de nitreto cúbico de boro
E = Aresta arredondada (ER)



Pastilhas direitas externas
Pastilhas esquerdas internas



Pastilhas esquerdas externas
Pastilhas direitas internas

H

CoroThread® 266

Suportes convencionais, versão métrica

266	R	FG	Z	3232	-	22
1	2	4	5	6		3

Barra de mandril, métrica

266	R	KF	Z	32	-	22	-	R	E
1	2	4	5	6		3		7	8

Unidade de corte Coromant Capto

C5	-	266	R	FG	Z	35	060	-	22
9		1	2	4	5	10	11		3



Cabeça de corte CoroThread® 266 SL

SL	-	266	R	KF	-	40	32	27	-	22
12		1	2	4		13	11	10		3

Cápsula

266	R	KF	-	20	C	A	-	22
1	2	4		14	15	16		3

1 Código principal	2 Versão da ferramenta	3 Dimensão/tamanho da pastilha
266 = CoroThread® 266 254 = CoroThread 254	R = Versão direita L = Versão esquerda	16 = <i>iC</i> 9.52 mm 22 = <i>iC</i> 12.70 mm 27 = <i>iC</i> 15.88 mm

4 Tipo de ferramenta e de suporte	5 Suporte para montagem com posição invertida
<p>Externa</p>  <p>FA FG</p> <p>Interna</p>  <p>KF</p>	<p>Z = Cabeça invertida para montagem invertida</p> 

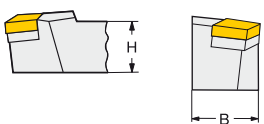
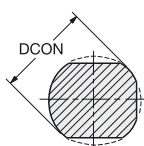
6 Dimensão da haste	7 Tipo de haste
<p>Externa</p> <p>Tamanho da haste H x B</p>  <p>Interna</p> <p>Diâmetro da haste, DCON</p> 	R = Haste redonda

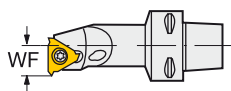
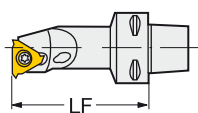
8 Tipo de barra	9 Tamanho Coromant Capto®	10 Dimensão WF, mm	11 Comprimento da ferramenta, dimensão LF, mm
E = Barra com haste de metal duro	<p>C = Coromant Capto® DCON = Código de tamanho</p> <p>C3 DCON = 32 mm C4 DCON = 40 mm C5 DCON = 50 mm C6 DCON = 63 mm C8 DCON = 80 mm</p>	 <p>WF</p>	 <p>LF</p> <p>Métrica Dimensão LF em mm</p>

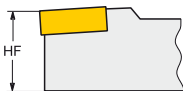
12 Unidade de corte	13 Tamanho do acoplamento SL	14 Altura da aresta de corte, HF mm	15 Tipo de ferramenta
Sistema SL	DCON - dimensão (diâm. do acoplamento)	 <p>HF</p>	C = Cápsula
			16 Tipo de desenho
			A = letra para desenhos alternativos conforme ISO 5611.

Lista de referência cruzada de materiais

ISO	MC	CMC	País										
			Europa	Alemanha	Grã-Bretanha	Suécia	EUA	França	Itália	Espanha	Japão		
			Norma DIN EN	W.-nr.	BS	EN	SS	AISI/SAE/ASTM	AFNOR	UNI	UNE	JIS	
P	Aços sem liga												
	P1.1.Z.AN	01.1	S235JR G2	1.0038	4360 40 C	-	1311	A570.36	E 24-2 Ne	-	-	STKM 12A;C	
	P1.1.Z.AN	01.1	S235J2 G3	1.0116	4360 40 B	-	1312	A573-81 65	E 24-U	Fe37-3	-	-	
	P1.1.Z.AN	01.1	C15	1.0401	080M15	-	1350	1015	CC12	C15C16	F.111	-	
	P1.1.Z.AN	01.1	C22	1.0402	050A20	2C/2D	1450	1020	CC20	C20C21	F.112	-	
	P1.1.Z.AN	01.1	C15E	1.1141	080M15	32C	1370	1015	XC12	C16	C15K	S15C	
	P1.1.Z.AN	01.1	C25E	1.1158	-	-	-	1025	-	-	-	S25C	
	P1.1.Z.AN	01.1	S380N	1.8900	4360 55 E	-	2145	A572-60	-	FeE390KG	-	-	
	P1.1.Z.AN	01.1	17MnV7	1.0870	4360 55 E	-	2142	A572-60	NFA 35-501 E 36	-	-	-	
	P1.1.Z.AN	02.1	55Si7	1.0904	250A53	45	2085	9255	55S7	55Si8	56Si7	-	
	P1.1.Z.AN	02.2	-	-	-	-	2090	9255	55S7	-	-	-	
	P1.2.Z.AN	01.2	C35	1.0501	060A35	-	1550	1035	CC35	C35	F.113	-	
	P1.2.Z.AN	01.2	C45	1.0503	080M46	-	1650	1045	CC45	C45	F.114	-	
	P1.2.Z.AN	01.2	40Mn4	1.1157	150M36	15	-	1039	35M5	-	-	-	
	P1.2.Z.AN	01.2	36Mn5	1.1167	-	-	2120	1335	40M5	-	36Mn5	SMn438(H)	
	P1.2.Z.AN	01.2	28Mn6	1.1170	150M28	14A	-	1330	20M5	C28Mn	-	SCMn1	
	P1.2.Z.AN	01.2	C35G	1.1183	060A35	-	1572	1035	XC38TS	C36	-	S35C	
	P1.2.Z.AN	01.2	C45E	1.1191	080M46	-	1672	1045	XC42	C45	C45K	S45C	
	P1.2.Z.AN	01.2	C53G	1.1213	060A52	-	1674	1050	XC48TS	C53	-	S50C	
	P1.2.Z.AN	01.3	C55	1.0535	070M55	-	1655	1055	-	C55	-	-	
	P1.2.Z.AN	01.3	C55E	1.1203	070M55	-	-	1055	XC55	C50	C55K	S55C	
	P1.2.Z.AN	02.1	S275J2G3	1.0144	4360 43C	-	1412	A573-81	E 28-3	-	-	SM 400A;B;C	
	P1.2.Z.AN	02.1	S355J2G3+C2	1.0570	4360 50B	-	2132	-	E36-3	Fe52BFN/Fe52CFN	-	SM490A;B;C;YA;YB	
	P1.2.Z.AN	02.1	S355J2G3	1.0841	150 M 19	-	2172	5120	20 MC 5	Fe52	F-431	-	
	P1.3.Z.AN	01.3	C60E	1.0601	080A62	43D	-	1060	CC55	C60	-	-	
	P1.3.Z.AN	01.3	C60E	1.1221	080A62	43D	1678	1060	XC60	C60	-	S58C	
	P1.3.Z.AN	01.4	C101E	1.1274	060 A 96	-	1870	1095	XC 100	-	F-5117	-	
	P1.3.Z.AN	01.4	C101u	1.1545	BW 1A	-	1880	W 1	Y105	C36KU	F-5118	SK 3	
	P1.3.Z.AN	01.4	C105W1	-	BW2	-	2900	W210	Y120	C120KU	F.515	SUP4	
	P1.3.Z.AN	02.1	S340 MGC	1.0961	-	-	-	9262	60SC7	60SiCr8	60SiCr8	-	
	P1.4.Z.AN	01.1	11SMn30	1.0715	230M07	-	1912	1213	S250	CF9SMn28	11SMn28	SUM22	
	P1.4.Z.AN	01.1	11SMnPb30	1.0718	-	-	1914	12L13	S250Pb	CF9SMnPb28	11SMnPb28	SUM22L	
	P1.4.Z.AN	01.1	10SPb20	1.0722	-	-	-	-	10PbF2	CF10SPb20	10SPb20	-	
	P1.4.Z.AN	01.1	11SMn37	1.0736	240M07	1B	-	1215	S 300	CF9SMn36	12SMn35	-	
	P1.4.Z.AN	01.1	11SMnPb37	1.0737	-	-	1926	12L14	S300Pb	CF9SMnPb36	12SMnP35	-	
	P1.4.Z.AN	01.2	35S20	1.0726	212M36	8M	1957	1140	35MF4	-	F210G	-	
	P1.5.C.UT	01.1	GC16E	1.1142	030A04	1A	1325	1115	-	-	-	-	
	Aços	Aços baixa-liga											
		P2.1.Z.AN	02.1	16Mo3	1.5415	1501-240	-	2912	A204Gr.A	15D3	16Mo3KW	16Mo3	-
		P2.1.Z.AN	02.1	14Ni6	1.5622	-	-	-	A350LF5	16N6	14Ni6	15Ni6	-
		P2.1.Z.AN	02.1	21NiCrMo2	1.6523	805M20	362	2506	8620	20NCD2	20NiCrMo2	20NiCrMo2	SNCM220(H)
		P2.1.Z.AN	02.1	17CrNiMo6	1.6587	820A16	-	-	-	18NCD6	-	14NiCrMo13	-
		P2.1.Z.AN	02.1	15Cr3	1.7015	523M15	-	-	5015	12C3	-	-	SCr415(H)
		P2.1.Z.AN	02.1	55Cr3	1.7176	527A60	48	-	5155	55C3	-	-	SUP9(A)
		P2.1.Z.AN	02.1	15CrMo5	1.7262	-	-	2216	-	12CD4	-	12CrMo4	SCM415(H)
		P2.1.Z.AN	02.1	13CrMo4-5	1.7335	1501-620Gr27	-	-	A182 F11;F12	15CD3.5	14CrMo4 5	14CrMo45	-
		P2.1.Z.AN	02.1	10CrMo9 10	1.7380	1501-622 Gr.31;45	-	2218	A182 F22	15CD4.5	12CrMo9, 10	TU.H	-
		P2.1.Z.AN	02.1	14MoV6 3	1.7715	1503-660-440	-	-	-	12CD9, 10	-	13MoCrV6	-
		P2.1.Z.AN	02.1	50CoMo4	1.7228	823M30	33	2512	-	-	653M31	-	-
		P2.1.Z.AN	02.2	14NiCr10	1.5732	-	-	-	3415	14NC11	16NiCr11	15NiCr11	SNC415(H)
		P2.1.Z.AN	02.2	14NiCr14	1.5752	655M13; A12	36A	-	3415;3310	12NC15	-	14NiCr11	SNC815(H)
		P2.1.Z.AN	02.1/02.2	16MnCr5	1.7131	(527M20)	-	2511	5115	16MC5	16MnCr5	16MnCr5	-
P2.1.Z.AN		02.1/02.2	34CrMo4	1.7220	708A37	19B	2234	4137;4135	35CD4	35CrMo4	34CrMo4	SCM432;SCCRM3	
P2.1.Z.AN		02.1/02.2	41CrMo4	1.7223	708M40	19A	2244	4140;4142	42CD4TS	41CrMo4	42CrMo4	SCM 440	
P2.1.Z.AN		02.1/02.2	42CrMo4	1.7225	708M40	19A	2244	4140	42CD4	42CrMo4	42CrMo4	SCM440(H)	
P2.1.Z.AN		03.11	14NiCrMo134	1.6657	832M13	36C	-	-	-	15NiCrMo13	14NiCrMo131	-	
P2.2.Z.AN		02.1	31CrMo12	1.8515	722 M 24	-	2240	-	30 CD 12	30CrMo12	F-1712	-	
P2.2.Z.AN		02.1	39CrMoV13 9	1.8523	897M39	40C	-	-	-	36CrMoV12	-	-	
P2.2.Z.AN		02.1	41CrS4	1.7039	524A14	-	2092	L1	-	105WCR 5	-	-	
P2.2.Z.AN		02.1	50NiCr13	1.2721	-	-	2550	L6	55NCV6	-	F-528	-	
P2.2.Z.AN		03.11	45WCrV7	1.2542	BS1	-	2710	S1	-	45WCrV8KU	45WCrSi8	-	
P2.2.Z.AN/P2.5.Z.HT		02.1/02.2	36CrNiMo4	1.6511	816M40	110	-	9840	40NCD3	38NiCrMo4(KB)	35NiCrMo4	-	
P2.2.Z.AN/P2.5.Z.HT		02.1/02.2	34CrNiMo6	1.6582	817M40	24	2541	4340	35NCD6	35NiCrMo6(KB)	-	-	
P2.2.Z.AN/P2.5.Z.HT		02.1/02.2	34Cr4	1.7033	530A32	18B	-	5132	32C4	34Cr4(KB)	35Cr4	SCr430(H)	
P2.2.Z.AN/P2.5.Z.HT		02.1/02.2	41Cr4	1.7035	530A40	18	-	5140	42C4	41Cr4	42Cr4	SCr440(H)	
P2.2.Z.AN/P2.5.Z.HT		02.1/02.2	32CrMo12	1.7361	722M24	40B	2240	-	30CD12	32CrMo12	F.124.A	-	
P2.2.Z.AN/P2.5.Z.HT		02.1/02.2	51CrV4	1.8159	735A50	47	2230	6150	50CV4	50CrV4	51CrV4	SUP10	
P2.2.Z.AN/P2.5.Z.HT		02.1/02.2	41CrAlMo7	1.8509	905M39	41B	2940	-	40CAD6, 12	41CrAlMo7	41CrAlMo7	-	
P2.3.Z.AN		02.1	100Cr6	1.3505	534A99	31	2258	52100	100C6	100C6	F.131	SUJ2	

Lista de referência cruzada de materiais

ISO	MC	CMC	País									
			Europa	Alemanha	Grã-Bretanha	Suécia	EUA	França	Itália	Espanha	Japão	
			Norma									
			DIN EN	W.-nr.	BS	EN	SS	AISI/SAE/ASTM	AFNOR	UNI	UNE	JIS
P	P2.3.Z.AN/H1.2.Z.HA	02.1/02.2	105WCr6	1.2419	-	-	2140	-	105WC13	10WCr6	105WCr5	SKS31
	P2.3.Z.AN/H1.2.Z.HA	-	-	-	-	-	-	-	-	107WCr5KU	-	SKS2, SKS3
	P2.3.Z.AN/H1.2.Z.HA	02.1/02.2	-	1.2714	-	-	-	L6	55NCDV7	-	F520.S	SKT4
	P2.3.Z.AN/H1.3.Z.HA	02.1/02.2	100Cr6	1.2067	BL3	-	-	L3	Y100C6	-	100Cr6	-
	P2.4.Z.AN	02.1	16MnCr5	1.7139	-	-	2127	-	-	-	-	-
	P2.5.Z.HT	02.1	16Mo5	1.5423	1503-245-420	-	-	4520	-	16Mo5	16Mo5	-
	P2.5.Z.HT	02.1	40NiCrMo8-4	1.6562	311-Type 7	-	-	8740	-	40NiCrMo2(KB)	40NiCrMo2	SNCM240
	P2.5.Z.HT	02.1	42Cr4	1.7045	-	-	2245	5140	-	-	42Cr4	SCr440
	P2.5.Z.HT	02.1	31NiCrMo14	1.5755	830 M 31	-	2534	-	-	-	F-1270	-
	P2.5.Z.HT	02.2	36NiCr6	1.5710	640A35	111A	-	3135	35NC6	-	-	SNC236
	P2.6.C.UT	02.1	22Mo4	1.5419	605A32	-	2108	8620	-	-	F520.S	-
	P2.6.C.UT	02.1/02.2	25CrMo4	1.7218	1717CDS110	-	2225	4130	25CD4	25CrMo4(KB)	AM26CrMo4	SCM420,SCM430
	P2.6.C.UT	06.2	-	-	-	-	2223	-	-	-	-	-
	Aços alta-liga											
P3.0.Z.AN	03.11	X210Cr12	1.2080	BD3	-	-	D3	Z200C12	X210Cr13KU	X210Cr12	SKD1	
P3.0.Z.AN	03.11	X43Cr13	1.2083	-	-	2314	-	-	X250Cr12KU	-	-	
P3.0.Z.AN	03.11	X40CrMoV5 1	1.2344	BH13	-	2242	H13	Z40CDV5	X35CrMoV05KU	X40CrMoV5	SKD61	
P3.0.Z.AN	03.11	X100CrMoV5 1	1.2363	BA2	-	2260	A2	Z100CDV5	X40CrMoV511KU	X100CrMoV5	SKD12	
P3.0.Z.AN	03.11	X210CrW12	1.2436	-	-	2312	-	-	X100CrMoV51KU	X210CrW12	SKD2	
P3.0.Z.AN	03.11	X30WCv9 3	1.2581	BH21	-	-	H21	Z30WCV9	X28W09KU	X30WCv9	SKD5	
P3.0.Z.AN	03.11	X165CrMoV 12	1.2601	-	-	2310	-	-	X30WCv9 3KU	X160CrMoV12	-	
P3.0.Z.AN	03.21	X155CrMoV12-1	1.2379	-	-	2736	HNV3	-	X165CrMoV12KU	-	-	
P3.0.Z.HT	03.11	X8Ni9	1.5662	1501-509;510	-	-	ASTM A353	-	X10Ni9	XBNI09	-	
P3.0.Z.HT	03.11	12Ni19	1.5680	-	-	-	2515	Z18N5	-	-	-	
P3.1.Z.AN	03.11	S6-5-2	1.3343	4959BA2	-	2715	D3	Z40CSD10	15NiCrMo13	-	SUH3	
P3.1.Z.AN	03.13	-	-	BM 2	-	2722	M 2	Z85WDCV	HS 6-5-2-2	F-5603.	SKH 51	
P3.1.Z.AN	03.13	HS 6-5-2-5	1.3243	BM 35	-	2723	M 35	6-5-2-5	HS 6-5-2-5	F-5613	SKH 55	
P3.1.Z.AN	03.13	HS 2-9-2	1.3348	HS 2-9-2	-	2782	M 7	-	HS 2-9-2	F-5607	-	
P3.2.C.AQ	06.33	G-X120Mn12	1.3401	Z120M12	-	2183	L3	Z120M12	XG120Mn12	X120Mn12	SCMnH/1	
Aços inoxidáveis ferríticos/martensíticos												
Aços	P5.0.Z.AN	05.11/15.11	X10CrAL13	1.4724	403S17	-	-	405	Z10C13	X10CrAl12	F.311	SUS405
	P5.0.Z.AN	05.11/15.11	X10CrAL18	1.4742	430S15	60	-	430	Z10CAS18	X8Cr17	F.3113	SUS430
	P5.0.Z.AN	05.11/15.11	X10CrAL2-4	1.4762	-	-	2322	446	Z10CAS24	X16Cr26	-	SUH446
	P5.0.Z.AN	05.11/15.11	X1CrMoTi18-2	1.4521	-	-	2326	S44400	-	-	-	-
	P5.0.Z.AN/P5.0.Z.HT	05.11/15.11	X6Cr13	1.4000	403S17	-	2301	403	Z6C13	X6Cr13	F.3110	SUS403
	P5.0.Z.AN/P5.0.Z.HT	-	X7Cr14	1.4001	-	-	-	-	-	-	F.8401	-
	P5.0.Z.AN/P5.0.Z.HT	05.11/15.11	X10Cr13	1.4006	410S21	56A	2302	410	Z10C14	X12Cr13	F.3401	SUS410
	P5.0.Z.AN/P5.0.Z.HT	05.11/15.11	X6Cr17	1.4016	430S15	960	2320	430	Z8C17	X8Cr17	F.3113	SUS430
	P5.0.Z.AN/P5.0.Z.HT	05.11/15.11	X6CrAL13	1.4002	405S17	-	-	405	Z8CA12	X6CrAl13	-	-
	P5.0.Z.AN/P5.0.Z.HT	05.11/15.11	X20Cr13	1.4021	420S37	-	2303	420	Z20C13	X20Cr13	-	-
	P5.0.Z.AN/P5.0.Z.HT	05.11/15.11	X6CrMo17-1	1.4113	434S17	-	2325	434	Z8CD17.01	X8CrMo17	-	SUS434
	P5.0.Z.HT	03.11	X45CrS9-3-1	1.4718	401S45	52	-	HW3	Z45CS9	X45CrSi8	F.322	SUH1
	P5.0.Z.HT	05.11/15.11	X85CrMoV18-2	1.4748	443S65	59	-	HNV6	Z80CSN20.02	X80CrSiNi20	F.320B	SUH4
	P5.0.Z.HT	05.11/15.11	X20CrMoV12-1	1.4922	-	-	2317	-	-	X20CrMoNi 12.01	-	-
	P5.0.Z.PH	05.11/15.11	X12CrS13	1.4005	416 S 21	-	2380	416	Z11CF13	X12 CrS 13	F-3411	SUS 416
	P5.0.Z.PH	05.11/15.11	X46Cr13	1.4034	420S45	56D	2304	-	Z40CM	X40Cr14	F.3405	SUS420J2
	P5.0.Z.PH	05.11/15.11	X19CrNi17-2	1.4057	431S29	57	2321	431	Z15CNI6.02	X16CrNi16	F.3427	SUS431
	P5.0.Z.PH	05.12/15.12	X5CrNiCuNb16-4	1.4542 1.4548	-	-	-	630	Z7CNU17-04	-	-	-
	P5.0.Z.PH	15.21	X4 CrNiMo16-5	1.4418	-	-	-	2387	-	Z6CND16-04-01	-	-
P5.1.Z.AN/P5.0.Z.HT	05.11/15.11	X14CrMoS17	1.4104	-	-	2383	430F	Z10CF17	X10CrS17	F.3117	SUS430F	
Marcas												
P2.1.Z.AN	02.1											OVAKO 520M (Ovako Steel)
P2.2.Z.AN	02.1		1.0045									FORMAX (Uddeholm Tooling)
P2.2.Z.AN	02.1											IMACRO NIT (Imatra Steel)
P2.5.Z.HT	02.2											INEXA 482 (XM) (Inexa Profil)
P1.2.Z.AN												S355J2G3(XM)
P1.2.Z.AN												C45(XM)
P1.2.Z.AN												16MnCrS5(XM)
P2.5.Z.HT												INEXA280(XM)
P2.5.Z.HT	02.2											070M20(XM)
P2.5.Z.HT	02.2											HARDOX 500 (SSAB – Swedish Steel Corp.)
P2.5.Z.HT												WELDOX 700 (SSAB – Swedish Steel Corp.)

Lista de referência cruzada de materiais

ISO	MC	CMC	País										
			Europa	Alemanha	Grã-Bretanha	Suécia	EUA	França	Itália	Espanha	Japão		
			Norma										
DIN EN	W.-nr.	BS	EN	SS	AISI/SAE/ASTM	AFNOR	UNI	UNE	JIS				
M	Aços inoxidáveis austeníticos												
	M1.0.Z.AQ	05.11/15.11	X3CrNiMo13-4	1.4313	425C11	-	2385	CA6-NM	Z4CND13.4M Z38C13M	(G)X6CrNi304	-	SCS5	
	M1.0.Z.AQ/M1.0.C.UT	05.11/15.11	X53CrMnNiN21-9	1.4871	349S54	-	-	EV8	Z52CMN21.09	X53CrMnNiN21 9	-	SUH35, SUH36	
	M1.0.Z.AQ/M1.0.C.UT	05.21/15.21	X2CrNiN18-10	1.4311	304S62	-	2371	304LN	Z2CN18.10	-	-	SUS304LN	
	M1.0.Z.AQ/M1.0.C.UT	05.21/15.21	X2CrNiMoN17-13-3	1.4429	-	-	2375	316LN	Z2CND17.13	-	-	SUS316LN	
	M1.0.Z.AQ/M1.0.C.UT	05.21/15.21	X2CrNiMo17-12-2	1.4404	316S13	-	2348	316L	Z2CND17-12	X2CrNiMo1712	-	-	
	M1.0.Z.AQ/M1.0.C.UT	05.21/15.21	X2CrNiMo18-14-3	1.4435	316S13	-	2353	316L	Z2CND17.12	X2CrNiMo17 12	-	SCS16, SUS316L	
	M1.0.Z.AQ/M1.0.C.UT	05.21/15.21	X3CrNiMo17-3-3	1.4436	316S33	-	2343, 2347	316	Z6CND18-12-03	X8CrNiMo1713	-	-	
	M1.0.Z.AQ/M1.0.C.UT	05.21/15.21	X2CrNiMo18-15-4	1.4438	317S12	-	2367	317L	Z2CND19.15	X2CrNiMo18 16	-	SUS317L	
	M1.0.Z.AQ/M1.0.C.UT	05.21/15.21	X6CrNiN18-10	1.4550	347S17	58F	2338	347	Z6CNS18.10	X6CrNiN18 11	F.3552 F.3524	SUS347	
	M1.0.Z.AQ/M1.0.C.UT	05.21/15.21	X6CrNiMoTi17-12-2	1.4571	320S17	58J	2350	316Ti	Z6NDT17.12	X6CrNiMoTi17 12	F.3535	-	
	M1.0.Z.AQ/M1.0.C.UT	05.21/15.21	X10CrNiMoNb 18-12	1.4583	-	-	-	318	Z6CNDNb17 13B	X6CrNiMoNb17 13	-	-	
	M1.0.Z.AQ/M1.0.C.UT	05.21/15.21	X15CrNiSi20-12	1.4828	309S24	-	-	309	Z15CNS20.12	-	-	SUH309	
	M1.0.Z.AQ/M1.0.C.UT	05.21/15.21	X2CrNiMoN17-11-2	1.4406	301S21	58C	2370	308	Z1NCDU25.20	-	F.8414	SCS17	
	M1.0.Z.AQ	05.21/15.21	X1CrNiMoCuN20-18-7	1.4547	-	-	2378	S31254	Z1CNDU20-18-06AZ	-	-	-	
	M1.0.Z.AQ/M1.0.C.UT	05.21/15.21	X9CrNi18-8	1.4310	-	-	2331	301	Z12CN17.07	X12CrNi17 07	F.3517	SUS301	
	M1.0.Z.PH	05.22/15.22	X7CrNiAl17-7	1.4568	1.4504	316S111	-	-	17-7PH	Z8CNA17-07	-	-	
	M1.0.Z.AQ/M1.0.C.UT	05.21/15.21	X2CrNi19-11	1.4306	304S11	-	2352	304L	Z2CN18-10	X2CrNi18 11	-	-	
	Aços inoxidáveis	M1.1.Z.AQ	05.21/15.21	-	-	304S31	58E	2332, 2333	304	Z6CN18.09	X5CrNi18 10	F.3504 F.3541	SUS304
		M1.1.Z.AQ	05.21/15.21	X5CrNi18-10	1.4301	304S15	58E	2332	304	Z6CN18.09	X5CrNi18 10	F.3551	SUS304
		M1.1.Z.AQ	05.21/15.21	X5CrNiMo17-2-2	1.4401	316S16	58J	2347	316	Z6CND17.11	X5CrNiMo17 12	F.3543	SUS316
		M1.1.Z.AQ	05.21/15.21	X6CrNiTi18-10	1.4541	321S12	58B	2337	321	Z6CNT18.10	X6CrNiTi18 11	F.3553 F.3523	SUS321
		M1.2.Z.AQ	05.21/15.21	X8CrNiSi18-9	1.4305	303S21	58M	2346	303	Z10CNF 18.09	X10CrNiSi 18.09	F.3508	SUS303
		Aços inoxidáveis super austeníticos (Ni>20%)											
		M2.0.C.AQ	20.11	G-X40NiCrSi36-18	1.4865	330C11	-	-	-	-	XG50NiCr39 19	-	SCH15
		M2.0.Z.AQ	05.21/15.21	X1NiCrMoCu25-20-5	1.4539	-	-	2562	UNS V 0890A	Z2 NCDU25-20	-	-	-
		M2.0.Z.AQ	05.21/15.21	X8CrNi25-21	1.4845	310S24	-	2361	310S	Z12CN25 20	X6CrNi25 20	F.331	SUH310
		M2.0.Z.AQ	20.11	X12NiCrSi36 16	1.4864	-	-	-	330	Z12NCS35.16	F-3313	-	SUH330
		M2.0.Z.AQ	05.23/15.23	X1NiCrMoCu31-27-4	1.4563	-	-	2584	NO8028	Z1NCDU31-27-03	-	-	-
		Aços inoxidáveis Duplex (austeníticos/ferríticos)											
		M3.1.Z.AQ/M3.1.C.AQ	05.51/15.51	X2CrNiN23-4	1.4362	-	-	2376	S31500	-	-	-	-
		M3.1.Z.AQ/M3.1.C.AQ	05.51/15.51	X8CrNiMo27-5	-	-	-	2324	S32900	-	-	-	-
		M3.2.Z.AQ/M3.2.C.AQ	05.52/15.52	X2CrNiN23-4	-	-	-	2327	S32304	Z2CN23-04AZ	-	-	-
	M3.2.Z.AQ/M3.2.C.AQ	05.52/15.52	-	-	-	-	2328	-	-	-	-	-	
	M3.2.Z.AQ/M3.2.C.AQ	05.52/15.52	X2CrNiMoN22-53	-	-	-	2377	S31803	Z2CND22-05-03	-	-	-	
	Aços inoxidáveis	M1.1.Z.AQ	05.21/15.21										
		M1.1.Z.AQ	05.21/15.21		1.0045								
		M1.1.Z.AQ	05.21/15.21										
		M1.1.Z.AQ	05.21/15.21										
		M1.0.Z.AQ	05.23/15.23										
		M2.0.Z.AQ	05.23/15.23										
		M3.2.Z.AQ	05.52/15.52										
	M3.2.Z.AQ	05.52/15.52											
	Marcas												
	M1.1.Z.AQ	05.21/15.21											
M1.1.Z.AQ	05.21/15.21												
M1.1.Z.AQ	05.21/15.21												
M1.1.Z.AQ	05.21/15.21												
M1.0.Z.AQ	05.23/15.23												
M2.0.Z.AQ	05.23/15.23												
M3.2.Z.AQ	05.52/15.52												
M3.2.Z.AQ	05.52/15.52												

Lista de referência cruzada de materiais

ISO	MC	CMC	País									
			Europa	Alemanha	Grã-Bretanha	Suécia	EUA	França	Itália	Espanha	Japão	
			Norma DIN EN	W.-nr.	BS	EN	SS	AISI/SAE/ASTM	AFNOR	UNI	UNE	JIS
K	Ferros fundidos maleáveis											
	K1.1.C.NS	07.1	-	-	8 290/6	-	0814	-	MN 32-8	-	-	FCMB310
	K1.1.C.NS	07.1	EN-GJMB350-10	0.8135	B 340/12	-	0815	32510	MN 35-10	-	-	FCMW330
	K1.1.C.NS	07.2	EN-GJMB450-6	0.8145	P 440/7	-	0852	40010	Mn 450	GMN 45	-	FCMW370
	K1.1.C.NS	07.2	EN-GJMB550-4	0.8155	P 510/4	-	0854	50005	MP 50-5	GMN 55	-	FCMP490
					P 570/3		0858	70003	MP 60-3			FCMP540
	K1.1.C.NS	07.2	EN-GJMB650-2	0.8165	P570/3	-	0856	A220-70003	Mn 650-3	GMN 65	-	FCMP590
	K1.1.C.NS	07.3	EN-GJMB700-2	0.8170	P690/2	-	0862	A220-80002	Mn700-2	GMN 70	-	FCMP690
	Ferros fundidos cinzentos											
	K2.1.C.UT	08.1	-	-	-	-	0100	-	-	-	-	-
	K2.1.C.UT	08.1	EN-GJL-100	0.6010	-	-	0110	No 20 B	Ft 10 D	-	-	FC100
	K2.1.C.UT	08.1	EN-GJL-150	0.6015	Grade 150	-	0115	No 25 B	Ft 15 D	G 15	FG 15	FC150
	K2.1.C.UT	08.1	EN-GJL-200	0.6020	Grade 220	-	0120	No 30 B	Ft 20 D	G 20	-	FC200
	K2.1.C.UT	08.2	EN-GJL-250	0.6025	Grade 260	-	0125	No 35 B	Ft 25 D	G 25	FG 25	FC250
	K2.1.C.UT	08.2	EN-JLZ	0.6040	Grade 400	-	0140	No 55 B	Ft 40 D	-	-	-
	K2.2.C.UT	08.2	EN-GJL-300	0.6030	Grade 300	-	0130	No 45 B	Ft 30 D	G 30	FG 30	FC300
	K2.2.C.UT	08.2	EN-GJL-350	0.6035	Grade 350	-	0135	No 50 B	Ft 35 D	G 35	FG 35	FC350
	K2.3.C.UT	08.3	GGL-NiCr20-2	0.6660	L-NiCuCr202	-	0523	A436 Type 2	L-NC 202	-	-	-
	Ferros fundidos nodulares											
	K3.1.C.UT	09.1	EN-GJS-400-15	0.7040	SNG 420/12	-	0717-02	60-40-18	FCS 400-12	GS 370-17	FGE 38-17	FCD400
	K3.1.C.UT	09.1	EN-GJS-400-18-LT	0.7043	SNG 370/17	-	0717-12	-	FGS 370-17	-	-	-
	K3.1.C.UT	09.1	EN-GJS-350-22-LT	0.7033	-	-	0717-15	-	-	-	-	-
	K3.1.C.UT	09.1	EN-GJS-800-7	0.7050	SNG 500/7	-	0727	80-55-06	FGS 500-7	GS 500	FGE 50-7	FCD500
	K3.2.C.UT	09.2	EN-GJS-600-3	0.7060	SNG 600/3	-	0732-03	-	FGS 600-3	-	-	FCD600
	K3.3.C.UT	09.2	EN-GJS-700-2	0.7070	SNG 700/2	-	0737-01	100-70-03	FGS 700-2	GS 700-2	FGE 70-2	FCD700
K3.5.C.UT	-	EN-GJSA-XNiCr20-2	0.7660	Grade S6	-	0776	A43D2	S-NC 202	-	-	-	
Ferro vermicular												
K4.1.C.UT	-	EN-GJV-300										
K4.1.C.UT	-	EN-GJV-350										
K4.2.C.UT	-	EN-GJV-400										
K4.2.C.UT	-	EN-GJV-450										
K4.2.C.UT	-	EN-GJV-500										
Ferro dúctil austemperado												
K5.1.C.NS	-	EN-GJS-800-8	-	-	-	-	ASTM A897 No. 1	-	-	-	-	
K5.1.C.NS	-	EN-GJS-1000-5	-	-	-	-	ASTM A897 No. 2	-	-	-	-	
K5.2.C.NS	-	EN-GJS-1200-2	-	-	-	-	ASTM A897 No. 3	-	-	-	-	
K5.2.C.NS	-	EN-GJS-1400-1	-	-	-	-	ASTM A897 No. 4	-	-	-	-	
K5.3.C.NS	-	-	-	-	-	-	ASTM A897 No. 5	-	-	-	-	

Lista de referência cruzada de materiais

ISO	MC	CMC	País										
			Europa	Alemanha	Grã-Bretanha	Suécia	EUA	França	Itália	Espanha	Japão		
			Norma DIN EN	W.-nr.	BS	EN	SS	AISI/SAE/ASTM	AFNOR	UNI	UNE	JIS	
N Metais não ferrosos	Ligas à base de alumínio												
	N1.3.C.AG	30.21	G-AISI9MGWA	3.2373	-	-	4251	SC64D	A-S7G	-	-	C4BS	
	N1.3.C.UT	30.21	G-ALMG5	-	LM5	-	4252	GD-AISI12	A-SU12	-	-	AC4A	
	N1.3.C.UT/N1.3.C.AG	30.21/30.22	-	-	LM25	-	4244	356.1	-	-	-	A5052	
	N1.3.C.UT	-	GD-AISI12	-	-	-	4247	A413.0	-	-	-	A6061	
	N1.3.C.AG	-	GD-AISI8Cu3	-	LM24	-	4250	A380.1	-	-	-	A7075	
	N1.3.C.UT	-	G-AISI12(Cu)	-	LM20	-	4260	A413.1	-	-	-	ADC12	
	N1.3.C.UT	-	G-AISI12	-	LM6	-	4261	A413.2	-	-	-	-	
	N1.3.C.AG	-	G-AISI10Mg(Cu)	-	LM9	-	4253	A360.2	-	-	-	-	
S Super ligas resistentes ao calor	Ligas à base de níquel												
	S2.0.Z.AG	20.22	S-NiCr13A16MoNb	LW2 4670	mar-46	-	-	5391	NC12AD	-	-	-	
	S2.0.C.UT	20.24	NiCo15Cr10MoAlTi	LW2 4674	-	-	-	AMS 5397	-	-	-	-	
	S2.0.Z.AG	20.22	NiFe35Cr14MoTi	LW2.4662	-	-	-	5660	ZSNCDT42	-	-	-	
	S2.0.Z.AG	20.22	NiCr19Fe19NbMo	LW2.4668	HR8	-	-	5383	NC19eNB	-	-	-	
	S2.0.Z.AG	20.22	NiCr20TiAk	2.4631	Hr401.601	-	-	-	NC20TA	-	-	-	
	S2.0.Z.AG	20.22	NiCr19Co11MoTi	2.4973	-	-	-	AMS 5399	NC19KDT	-	-	-	
	S2.0.Z.AG	20.22	NiCr19Fe19NbMo	LW2.4668	-	-	-	AMS 5544	NC20K14	-	-	-	
	S2.0.Z.AN	20.21	-	2.4603	-	-	-	5390A	NC22FeD	-	-	-	
	S2.0.Z.AN	20.21	NiCr22Mo9Nb	2.4856	-	-	-	5666	NC22FeDNB	-	-	-	
	S2.0.Z.AN	20.21	NiCr20Ti	2.4630	HR5.203-4	-	-	-	NC20T	-	-	-	
	S2.0.Z.AG	20.22	NiCu30AL3Ti	2.4375	3072-76	-	-	4676	-	-	-	-	
	Ligas à base de cobalto												
	-	-	CoCr20W15Ni	-	-	-	-	5537C, AMS	KC20WN	-	-	-	
S3.0.Z.AG	20.32	CoCr22W14Ni	LW2.4964	-	-	-	5772	KC22WN	-	-	-		
Ligas de titânio													
S4.2.Z.AN	23.22	TiAl5Sn2.5	3.7115.1	TA14/17	-	-	UNS R54520	T-A5E	-	-	-		
S4.2.Z.AN	23.22	TiAl6V4	3.7165.1	TA10-13/TA28	-	-	UNS R56401	UNS R56400	-	-	-		
S4.3.Z.AN	23.22	TiAl5V5Mo5Cr3	-	-	-	-	-	T-A6V	-	-	-		
S4.2.Z.AN	23.22	TiAl4Mo4Sn4Si0.5	3.7185	-	-	-	-	-	-	-	-		
H Materiais endurecidos	Marcas												
	Materiais endurecidos	Ligas à base de ferro											
		S2.0.Z.UT/S2.0.Z.AN	20.11	Incoloy 800									
		Ligas à base de níquel											
		S2.0.Z.AN	20.2	Haynes 600									
		S2.0.Z.AN	20.2	Nimocast PD16									
		S2.0.Z.AG	20.2	Nimonic PE 13									
		S2.0.Z.AG	20.2	Rene 95									
		S2.0.Z.AN	20.21	Hastelloy C									
		S2.0.Z.AN	20.21	Incoloy 825									
		S2.0.Z.AN	20.21	Inconel 600									
		S2.0.Z.AN	20.21	Monel 400									
		S2.0.Z.AG	20.22	Inconel 700									
		S2.0.Z.AG	S2.0.Z.AG	Inconel 718									
		S2.0.Z.AG	20.22	Mar - M 432									
		S2.0.Z.AG	20.22	Nimonic 901									
S2.0.Z.AG		20.22	Waspaloy										
S2.0.C.NS	20.24	Jessop G 64											
Ligas à base de cobalto													
S3.0.Z.AG	20.3	Resist. ar 213											
S3.0.Z.AG	20.3	Jetalloy 209											
H Materiais endurecidos	Materiais endurecidos												
	H1.2.Z.HA	04.1	X100CrMo13	1.4108	-	-	2258 08	440A	-	-	-	C4BS	
	H1.3.Z.HA	04.1	X110CrMoV15	1.4111	-	-	2534 05	610	-	-	-	AC4A	
H1.2.Z.HA	04.1	X65CrMo14	-	-	-	2541 06	0-2	-	-	-	AC4A		

Para a segurança do meio-ambiente

Conheça o novo Conceito de Reciclagem da Coromant (CRC)!

O Conceito de Reciclagem da Coromant (CRC) é um serviço abrangente, oferecido pela Sandvik Coromant para pastilhas de metal duro usadas, em todos os seus respectivos clientes. Em tempos do aumento de consumo de matérias-primas não renováveis, o gerenciamento econômico de recursos escassos é um dever de todos os fabricantes. A Sandvik Coromant está fazendo a parte dela oferecendo-se para coletar pastilhas de metal duro e ferramentas inteiriças de metal duro usadas e reciclá-las de maneira o mais favorável possível ao meio-ambiente. Todas as pastilhas de metal duro são recolhidas em uma caixa de coleta no próprio local de trabalho. Quando a caixa de coleta ficar suficientemente cheia, o seu conteúdo é então transferido para a caixa de transporte a qual é enviada para a Sandvik Coromant, ou um distribuidor/representante Coromant mais próximo, que também pode lhe fornecer mais detalhes a respeito.



Os benefícios do CRC (Conceito de Reciclagem da Coromant) falam por si só!

- Um sistema de reciclagem mundial exclusivo.
- Para todos os nossos clientes e clientes de nossos distribuidores.
- Procedimento simples com caixas de coleta e transporte.
- Menos sucata para preservação do meio ambiente.
- Melhor utilização de recursos.
- Pastilhas de metal duro de outros fabricantes também são aceitas.

Solicite caixas de coleta para cada torno, fresadora, furadeira ou para seu centro de usinagem. Recomendamos uma caixa de coleta para as pastilhas e uma caixa separada para ferramentas inteiriças de metal duro para cada local em que se realize uma operação de usinagem. Para instruções detalhadas sobre como vender suas pastilhas de metal duro usadas, visite www.sandvik.coromant.com/br e selecione o seu mercado.

Caixa de coleta:

Caixa de transporte para ferramentas inteiriças de metal duro (madeira):

Caixa de transporte para pastilhas (madeira):

Códigos para pedido

91617

92994

92995

Informações sobre segurança

Informações sobre segurança para afiação do metal duro

Composição do material

Porta-ferramentas

Os porta-ferramentas contêm principalmente ferro (FE) e elementos de baixa-liga como cromo, níquel, manganês, molibdênio e silício.

Pastilhas intercambiáveis/ferramentas de corte/ferramentas rotativas

As substâncias de produtos de metais duros contêm principalmente carboneto de tungstênio e cobalto. Elas também podem conter carbonetos e carbonitreto dos seguintes elementos: titânio, tântalo, nióbio, cromo, molibdênio e vanádio.

Rotas de exposição

A afiação ou aquecimento do blank de metal duro, ou de um produto de metal duro produzirá poeira ou fumaça com elementos perigosos que podem ser inalados, tragados ou entrar em contato com a pele ou olhos.

Toxidade elevada

O pó é tóxico quando inalado e essa inalação pode ocasionar irritação das vias respiratórias. Uma inalação mais grave em termos de toxicidade é a inalação combinada de carboneto de tungstênio e cobalto, comparada com a inalação só de cobalto. O contato com a pele pode causar irritação e rachaduras. Pessoas sensíveis podem apresentar uma reação alérgica.

Toxidade crônica

A inalação repetida de aerossóis que contenham cobalto pode causar obstrução das vias respiratórias. A inalação prolongada de altas concentrações pode causar fibrose ou câncer de pulmão. Estudos epidemiológicos indicam que trabalhadores que no passado estiveram expostos a altas concentrações de carboneto de tungstênio/cobalto carregam um alto risco de desenvolver câncer de pulmão.

O cobalto e o níquel são agentes em potencial para causar irritações na pele. Um contato repetido ou prolongado pode causar irritação.

Fases de risco

Tóxico: perigo de sérios danos à saúde devido à exposição prolongada por inalação

Tóxico quando inalado

Evidências limitadas de efeito cancerígeno.

Pode causar sensibilidade pela inalação e contato com a pele

Medidas preventivas

Evite a formação e a inalação do pó. Use ventilação local por exaustão adequada para manter a exposição pessoal bem abaixo dos limites nacionais autorizados.

Se não houver ventilação ou ela for inadequada, use máscaras respiratórias aprovadas nacionalmente para esse fim.

Use óculos de segurança com laterais quando necessário.

Evite contato repetitivo com a pele. Use luvas adequadas. Lave bem as mãos depois do manuseio.

Use roupas protetoras adequadas. Lave as roupas quando necessário.

Não coma, beba ou fume na área de trabalho. Lave a pele bem antes de comer, beber ou fumar.



Tailor Made

Opções adicionais de ferramentas desenhadas conforme suas necessidades específicas.



Além de um abrangente programa standard, nós podemos lhe oferecer ferramentas sob medida. Com o nosso serviço Tailor Made você está livre para especificar suas próprias dimensões sem ter que pagar pelo preço de uma ferramenta especial.

O que você pode esperar de nós

- Cotação rápida
- Pedido fácil
- Garantia de desempenho nos produtos e dados de corte determinados
- Prazos de entrega competitivos

The image shows a detailed technical form for the CoroMill 490 tool. It includes sections for:

- Customer Information:** Name, address, telephone, and fax.
- Product Selection:** Options for cylindrical, waisted, Coromant Capto, and HSK type A geometries.
- Technical Specifications:** Tables for dimensions (D₁, D₂, L, etc.) for different tool sizes and materials.
- Options:** A section for specifying additional features like insert size, diameter, and length.
- Ordering Information:** Fields for quantity, customer denomination, and a note about standard vs. tailored design.

A opção Tailor Made está disponível nas seguintes famílias de produtos:

Pastilhas - metal duro

- CoroCut® 1-2
- CoroCut® QD
- CoroCut® 3
- T-Max® Q-Cut
- CoroThread® 266
- T-Max® U-Lock

Pastilhas - CBN

- T-Max® P
- T-Max®
- CoroTurn® 107
- CoroTurn® 111
- CoroTurn® TR
- CoroCut®

Pastilhas - PCD

- CoroTurn® 107
- CoroTurn® 111
- CoroCut®

Ferramentas

- CoroTurn® 300
- CoroTurn® TR
- CoroCut® 1-2
- CoroCut® QD
- CoroCut® 3
- T-Max® Q-Cut

Adaptadores

- Coromant Capto®

Soluções específicas para a área da engenharia

Quando nossas soluções standard ou Tailor Made não atenderem às suas necessidades, você pode contar com a ampla experiência da Sandvik Coromant em soluções de ferramentas específicas para lidar com critérios exigentes na área da engenharia.

Acesse nossos formulários Tailor Made em www.sandvik.coromant.com

Para facilitar a vida, uma nova norma foi desenvolvida

A ISO 13399 é uma norma internacional que simplifica a troca de dados para ferramentas de corte. Você observará uma diferença nos novos parâmetros e descrições de cada ferramenta.

Pela primeira vez, há uma maneira padronizada de descrever os dados de produtos referentes às ferramentas de corte disponíveis. Quando todas as ferramentas na indústria compartilham os mesmos parâmetros e definições, comunicar as informações das ferramentas entre os sistemas de software torna-se algo muito mais rápido.

O que isso significa para você?

Basicamente, significa que seus sistemas podem conversar com os nossos, pois falam a mesma língua. Baixe os dados do produto de nosso website e use-os diretamente em seu software CAD/CAM para montar as ferramentas que você usa na produção. Não há necessidade de procurar informações em catálogos e interpretar dados de um sistema para outro. Imagine quanto tempo você economizará!

Nome abreviado

Nome recomendado

ADJLN	Limite mínimo de ajuste
ADJLX	Limite máximo de ajuste
ADJRG	Faixa de ajuste
ALP	Ângulo de folga axial
AN	Ângulo de folga principal
ANN	Ângulo de folga menor
APMX	Profundidade de corte máxima
B	Largura da haste
BAWS	Ângulo do corpo - lado da peça
BAMS	Ângulo do corpo - lado da máquina
BBD	Balancedo pelo desenho
BBR	Balancedo por teste rotacional
BCH	Comprimento do chanfro de canto
BD	Diâmetro do corpo
BHTA	Ângulo do cone de transição
BN	Largura da fase frontal
BS	Comprimento da aresta alisadora
BSG	Norma
BSR	Raio da aresta alisadora
CBMD	Fabricante de quebra-cavaco
CDX	Ângulo da aresta transversal
CF	Chanfro
CHBA	Ângulo do chanfro no corpo
CHBL	Comprimento do chanfro do corpo
CHW	Largura do chanfro de canto
CHWL	Largura do chanfro do canto, versão esquerda
CHWR	Largura do chanfro do canto, versão direita
CICT	Número de cortes
CND	Diâmetro de entrada para refrigeração
CNSC	Código do tipo de entrada de refrigeração
CNT	Tamanho da rosca da entrada para refrigeração
COATING	Cobertura
CP	Pressão máx. de refrigeração
CRKS	Tamanho da rosca do tirante de tração
CRNT	Tamanho da rosca de entrada radial de refrigeração
CTPT	Tipo de operação
CUTDIA	Máximo diâmetro de corte da peça
CW	Largura de corte
CWN	Largura mínima de corte
CWTOLL	Menor tolerância da largura de corte
CWTOLU	Maior tolerância da largura de corte
CWX	Largura máxima de corte
CXSC	Código do tipo de saída para refrigeração
CZC	Código do tamanho da conexão
CZC _{MS}	Código do tamanho de conexão - lado da máquina
CZC _{WS}	Código do tamanho de conexão - lado da peça
D1	Diâmetro do furo de fixação
DAH	Diâmetro do furo de acesso
DAXIN	Diâmetro interno mínimo do canal axial
DAXN	Diâmetro externo mínimo do canal axial

DAXX	Diâmetro externo máximo do canal axial
DBC	Diâmetro do círculo para fixação
DC	Diâmetro de corte
DCB	Diâmetro do furo de conexão
DCBN	Diâmetro mínimo do furo de conexão
DCBX	Diâmetro máximo do furo de conexão
DCF	Diâmetro de corte da face de contato
DCN	Mínimo diâmetro de corte
DCON	Diâmetro de conexão
DCON _{MS}	Diâmetro de conexão - lado da máquina
DCON _{WS}	Diâmetro de conexão - lado da peça
DCONN _{WS}	lado mínimo da peça com o diâmetro de conexão
DCONX _{WS}	lado máximo da peça com o diâmetro de conexão
DCPS	Tamanho do alojamento para chip de dados.
DCSF _{MS}	Diâmetro da superfície de contato - lado da máquina
DCSF _{WS}	Diâmetro da superfície de contato - lado da peça
DCX	Máximo diâmetro de corte
DIX	Máximo diâmetro para interferência no trocador de ferramenta
DMIN	Diâmetro mínimo do furo
DMM	Diâmetro da haste
DN	Diâmetro do pescoço
DSGN	Desenho
EPSR	Ângulo da pastilha
FHA	Ângulo de hélice do canal
FLGT	Espessura da flange
FTDZ	Tamanho do diâmetro para rosca
GB	Ângulo da face frontal
H	Altura da haste
HA	Altura teórica da rosca
HB	Diferença de altura da rosca
HBH	Altura do offset da cabeça até o fundo
HBL	Comprimento da cabeça
HC	Altura real da rosca
HF	Altura funcional
HRY	Menor ponto do plano de referência
HSUP	Altura de apoio
HTB	Altura do corpo
HTH	Altura
IC	Diâmetro do círculo inscrito
INSL	Comprimento da pastilha
INSUC	Código de uso da pastilha
IZC	Código do tamanho da pastilha
KAPR	Ângulo da aresta de corte da ferramenta
KCH	Chanfro de canto
KCHL	Chanfro do canto, versão esquerda
KCHR	Chanfro do canto, versão direita
KRINS	Ângulo da aresta de corte principal
KWW	Largura da chaveta
L	Comprimento da aresta de corte
LAMS	Ângulo de inclinação
LB	Comprimento do corpo
LCF	Comprimento do canal para cavacos
LCOX	Comprimento máximo de corte
LE	Comprimento efetivo da aresta de corte
LF	Comprimento útil
LH	Comprimento da cabeça
LPR	Comprimento de programação
LS	Comprimento da haste
LSC	Comprimento de fixação
LSCN	Comprimento mínimo de fixação
LSCS	Distância até o início da fixação
LSCX	Comprimento máximo de fixação
LSD	Comprimento da haste
LU	Comprimento útil (máx. recomendado)
LUX	Comprimento máximo utilizável
MHD	Distância do furo de montagem
MIID	Identificação da pastilha padrão
MMCC	Código para torque de pré-set
MMCX	Torque de corte máximo
NOF	Número de canais
NT	Número de dentes
OAH	Altura total

A	OAL	Comprimento total	
	OAW	Largura total	
	OH	Balanço recomendado	
	OHN	Balanço mínimo	
B	OHX	Balanço máximo	
	ORDCODE	Código de pedido	
	PCL	Comprimento cilíndrico periférico	
	PDX	Distância ex do perfil	
	PDY	Distância ey do perfil	
	PHD	Diâmetro do furo pré-usinado	
	PHDX	Diâmetro máximo do furo pré-usinado	
	PL	Comprimento da ponta	
	PNA	Ângulo do perfil	
	PRFRAD	Raio do perfil	
C	PRSPC	Especificação do perfil	
	PSIR	Ângulo de ataque da ferramenta	
	PSIRL	Ângulo da aresta de corte principal, versão esquerda	
	PSIRR	Ângulo da aresta de corte principal, versão direita	
	RADH	Altura radial do corpo	
	RADW	Largura radial do corpo	
	RAR	Ângulo de folga do lado direito	
	RE	Raio de canto	
	REEQ	Equivalente ao raio do canto	
	REL	Raio de canto esquerdo	
	RER	Raio de canto direito	
	RETOLL	Menor tolerância do raio de canto	
	D	RETOLU	Maior tolerância do raio de canto
RGL		Comprimento da reafiação	
RMPX		Ângulo máximo para usinagem em rampa	
RPMX		Rotação máxima	
S		Raio da peça	
SDL		Comprimento do diâmetro escalonado	
SIG		Ângulo da ponta	
SPTL		Linha de divisão	
SSC		Código do tamanho do assento da pastilha	
STA		Ângulo escalonado	
STDNO		Número da norma	
E		SUBSTRATE	Substrato
		TCDC	Classe de tolerância do diâmetro de corte
		TCDMM	Tolerância do diâmetro da haste
	TCHA	Tolerância atingível do furo	
	TCHAL	Menor tolerância atingível do furo	
	TCHAU	Maior tolerância atingível do furo	
	TCT	Classe de tolerância da ferramenta	
	TCTR	Classe de tolerância da rosca	
	TD	Diâmetro da rosca	
	TDZ	Dimensão da rosca	
	TFLA	Total flutuação do macho à frente	
	F	TFLB	Total flutuação do macho para trás
		TG	Gradiente do cone
		THCA	Ângulo de correção helicoidal da rosca
THCHT		Tipo de chanfro do macho	
THFT		Tipo de rosca	
THFTS		Tipo de rosca standard	
THL		Comprimento da rosca	
THUB		Espessura do cubo	
TP		Passo da rosca	
TPI		Fios por polegada	
TPIN		Mínimos fios por polegada	
G		TPIX	Máximos fios por polegada
		TPN	Passo mínimo da rosca
	TPX	Passo máximo da rosca	
	TQ	Torque	
	TRMAX	Gama de machos máx.	
	TSYC	Código da ferramenta	
	TTP	Tipo de rosca	
	ULDR	Relação comprimento/diâmetro útil	
	VCX	Velocidade de corte máxima	
	W1	Largura da pastilha	
H	WB	Largura do corpo	
	WF	Largura útil	
	WFCIRP	Largura para o ponto de referência da ferramenta de corte	

WSC	Largura de fixação
WT	Peso do item
ZADJ	número de pastilhas ajustáveis
ZEFF	Número efetivo de arestas de corte - frontal
ZEFP	Número efetivo de arestas de corte na periferia (ZEFP)
ZWX	Número máximo de pastilhas Wiper

Código	Página	Código	Página	Código	Página
131..-B	G5	3-80-M5	A17	CCLNR/L	A251
132L	G4	3-80-M5W	A17	CCMT	A41-A42
151.2	E11	392.T..SLxxR/L	F25, F27	CCMW	A44
254R/LG	B113	392.T63-131	F30	CDJNR/L	A252
254R/LKF	B114	5680 021	G7	CDNNR/L	A252
266R/LG..AC..F	C25	5692 063	G7	CNGA	A157-A159
266R/LG..MJ..A	C22	5693 066	G7	CNGG	A153
266R/LG..MM..A	C7-C8	5693 067	G7	CNGM	A159
266R/LG..NT..A	C17	5693 068	G7	CNGN	A243
266R/LG..PT..A	C19	570	F48	CNGQ	A157-A158
266R/LG..RN..A	C21	570..580-80	F50	CNGX	A156-A157, A159
266R/LG..SA..F	C26	570-200	F52	CNMA	A155, A157
266R/LG..TR..F	C24	570-2C	F37, F40	CNMG	A153-A156
266R/LG..UN..A	C11-C12	570-3C	F64-F66	CNMM	A154-A155
266R/LG..VM..A	C5	570-4..RA	F48	CNMX	A156
266R/LG..VW..A	C6	570-4C	F64	CP-25BR/L	A10
266R/LG..WH..A	C15	570-80	F49-F50, F52	CP-30AR/L	A11
266R/LL..AC..F	C25	570C-SVUBR/L	A143	CP-A	A4
266R/LL..MM..A	C9-C10	570-DCLNR/L	A227-A228	CP-B	A4
266R/LL..NT..A	C18	570-DDUNR/L	A230-A231, A238-A239	CRDCN	A254
266R/LL..PT..A	C19	570-DDXNR/L	A230-A231	CRDCR/L	A254
266R/LL..RN..A	C21	570-DSKNR/L	A232-A233	CRDNN	A255
266R/LL..SA..A	C26	570-DTFNR/L	A235-A236	CRSNR/L	A255
266R/LL..TR..F	C24	570-DVUNR/L	A237, A240-A241	CSBNR/L-4	A256
266R/LL..UN..A	C13-C14	570-SUCR/L	A132	CSBPR/L	A260
266R/LL..VM..A	C5	570-SDUCR/L	A135-A136, A148	CSDNN	A256
266R/LL..VW..A	C6	570-SDXCR/L	A135	CSDPN	A260
266R/LL..WH..A	C16	570-STFCR/L	A140	CSDPR/L	A260
266R/LFA	C36	570-SVLBR/L	A143-A144	CSGX..E	A250
266R/LFG	C34	570-SVPBR/L	A143	CSKNR/L	A257
266R/LFGZ	C35	570-SVQCR/L	A142	CSKPR/L	A260
266R/LKF	C41	570-SVUCR/L	A142, A149	CSNR/L	A256
266R/LKF-R	C40	570-xxNG	F32	CSSNR/L	A257
266R/LKF-RE	C40	570-xxR/L123..B	B36, B41-B42	CTDPR/L	A261
266RG..BU..A	C29	570-xxR/L123..C	B37	CTFPR/L	A261
266RG..MM..C	C7	570-xxR/L123T..B	B95	CTGNR/L..-ID	A258
266RG..MM..F	C7	570-xxR/L123U..B	B95	CTGPR/L	A261
266RG..NF..A	C20	570-xxR/L151.3	B106-B107	CTTPR/L	A261
266RG..NJ..A	C23	570-xxR/LF	F32	CU-3C..-Cx	F63
266RG..NT..C	C17	570-xxR/LSMAL	B100	Cx-131	F20
266RG..RD..A	C28	935-Cx-Efxx	F19	Cx-266R/L	C31-C33, C39
266RG..RN..F	C21	935-HTxx-EFxx	F29	Cx-266RS..HP	C30
266RG..UN..C	C11	935-Lxx-EFxx	F41	Cx-3-80-LR/L	A18
266RG..UN..F	C11	935-VDIxx-EFxx	E7	Cx-3-80-MN	A18
266RG..V38..A	C27	A		Cx-391.01	F3, G6
266RG..V40..A	C27	A..PCLNR/L	A222	Cx-391.02	F4-F6
266RG..V50..A	C27	A..PDUNR/L	A223	Cx-391.27	F20
266RG..VM..C	C5	A..PSKNR/L	A224	Cx-4-SL..AX	F13
266RG..VM..F	C5	A..PTFNR/L	A225	Cx-570..NG	F8
266RG..VW..C	C6	A..SCLCR/L	A100-A103	Cx-570..R/LF	F7, F12
266RG..VW..F	C6	A..SDQCR/L	A104-A107	Cx-570..R/LG	F9-F12
266RG..WH..C	C15	A..SDUCR/L	A104-A107, A122-A123	Cx-570-2C	F8-F9
266RG..WH..F	C15	A..SDXCR/L	A106-A107	Cx-570-3C	F54-F55, F58-F59
266RL..AC..A	C25	A..SRDDN-R	A108	Cx-570-4C	F56
266RL..BU..A	C29	A..SRXDR/L-R	A108	Cx-ABB	F21
266RL..MM..C	C9	A..SSKCR/L	A109-A110	Cx-APBA..HP	F23
266RL..MM..F	C9	A..STFCR/L	A111-A113, A115	Cx-APBR/L..HP	F23
266RL..NF..A	C20	A..STUCR/L	A114	Cx-ASHA..HP	F17
266RL..NT..C	C18	A..SVPBR/L	A116-A117, A121	Cx-ASHR/L	F17-F18
266RL..NT..F	C18	A..SVQBR/L	A117, A119, A121	Cx-ASHS..HP	F18
266RL..RD..A	C28	A..SVQCR/L	A118, A120	Cx-CCLNR/L	A262
266RL..RD..C	C28	A..SVUBR/L	A116-A117, A119, A121	Cx-CCNR/L	A262
266RL..RN..F	C21	A..SVUCR/L	A118, A120	Cx-CDJNR/L	A263
266RL..UN..C	C13	APBA-R/L-VDI..HP	E9	Cx-CP..AR/L	A5
266RL..UN..F	C13	APBR/L-VDI..HP	E9	Cx-CP..BR/L	A7
266RL..V38..A	C27	ASHA-R/L-VDI..HP	E8	Cx-CP-70BR/L	A8
266RL..V40..A	C27	ASHN-VDIxx..HP	E8	Cx-CP-75AR/L	A6
266RL..V50..A	C27	B		Cx-CP-A-25BR/L	A8
266RL..VM..C	C5	BA-R/LGC	E11	Cx-CP-A-30AR/L	A6
266RL..VM..F	C5	C		Cx-CRDCN	A264
266RL..VW..C	C6	C10-R/LC2095	E15	Cx-CRSCR/L	A264
266RL..VW..F	C6	CCBNR/L	A251	Cx-CRSNR/L	A265
266RL..WH..C	C16	CCET	A41	Cx-CSDNN	A266
266RL..WH..F	C16	CCGT	A42	Cx-CSKNR/L	A266
3021 012	G7	CCGW	A44	Cx-CSNR/L	A266
3-80-L4	A17	CCGX	A42-A43	Cx-CSSNR/L	A267

Código	Página	Código	Página	Código	Página
Cx-CXS	F22	CXS-xxT045..R/L	A275	MAFR/L	A277
Cx-DCKNR/L	A182	CXS-xxT090..R/L	A272-A273	MAGR/L	B98
Cx-DCLNR/L	A181	CXS-xxT098..R/L	A272-A274	MABL	B98
Cx-DCMNN	A180	CXS-xxT140..R/L	A275	MATR/L	C56-C58
Cx-DCRNR/L	A183	CXS-xxTE98..R/L	A273-A274	MB..Axx-HP	F45
Cx-DDHNR/L	A188	CXS-xxTH	C60-C65	MB..Exx	F45
Cx-DDJNR/L	A188	Cx-T-A11B11L	A9	MB..Exx..R	F38
Cx-DDMNR/L	A186	Cx-TB-CN12CN12	D6	MB..FA	B127
Cx-DDNNN	A187	Cx-T-DC	D3	MB..FAR	B128
Cx-DDUNR/L	A187	Cx-TR-D13	A23	MB..FB	B127
Cx-DRSNR/L	A190	Cx-TR-V13	A25-A26	MB..FBR	B128
Cx-DSDNN	A194	D		MB..G	B124-B126
Cx-DSKNR/L	A194	DCBNR/L	A202	MB..GX	B123
Cx-DSRNR/L	A194	DCET-UM	A45	MBG	F35
Cx-DSSNR/L	A195	DCGT-UM	A45	MB-xxTH	C67-C72
Cx-DTJNR/L	A196	DCGW	A47	N	
Cx-DVJNR/L	A198	DCGX-AL	A45	N123..A2	B33
Cx-DVMNR/L	A197	DCKNR/L	A202	N123T	B89, B91-B92
Cx-DVVNN	A198	DCLNR/L	A202	N123U	B89, B91-B92
Cx-DWLNR/L	A199	DCMT	A45-A46	N123x1..S	B13, B24
Cx-NC2000	E13	DCMW..FP	A47	N123x1-GM	B12
Cx-NC3000	E13	DCMX	A45	N123x1-GR	B12
Cx-NC3000-V	E5	DDHNR/L	A204	N123x1-RE	B23
Cx-NF123..B	B27	DDJNR/L	A204	N123x1-RM	B19
Cx-PCLNR/L..HP	A178-A179, A218	DDNNN	A204	N123x1-RO	B18, B21
Cx-PCMNN..HP	A178	DNGA	A163-A164	N123x1-RS	B24
Cx-PCRNR/L..HP	A200	DNGG-SGF	A160	N123x1-TF	B15
Cx-PDJNR/L..HP	A184-A185	DNGM..F-HGR	A164	N123x1-XB	B17
Cx-PDMNR/L..HP	A184	DNGN..T	A244	N123x2-AM	B22
Cx-PDUNR/L..HP	A185, A219	DNGQ	A163	N123x2-CF	B5
Cx-PMU-I50	G14	DNMA-KR	A162	N123x2-CM	B6
Cx-PRSCR/L	A189, A191	DNMG	A160-A162	N123x2-CR	B7
Cx-PSDNN..HP	A192	DNMM	A162	N123x2-GF	B9-B10
Cx-PSKNR/L..HP	A192, A220	DNMX	A160-A161	N123x2-GM	B11
Cx-PSRNR/L..HP	A192	DRSNR/L	A206	N123x2-RM	B19
Cx-PSSNR/L..HP	A193	DSBNR/L	A207	N123x2-RO	B18
Cx-PTFNR/L..HP	A221	DSDNN	A207	N123x2-TF	B15
Cx-QC-Cx..R	F6	DSKNR/L	A208	N123x2-TM	B16
Cx-QC-SL	F47	DSSNR/L	A208	N151.2-4U	B103
Cx-QD-R/LF..C..A	B57	DTJNR/L	A210	N151.3-4G	B102
Cx-QFT	B73	DVJNR/L	A212	N151.3-7G	B102
Cx-QFU	B74	DVPNR/L	A212	N151.3-7P	B103
Cx-R/L166.0	C51	DVVNN	A212	N151.3-A..-4G	B102
Cx-R/LC	E4-E5, E12, E15	DWLNR/L	A213	NF123..B	B30
Cx-R/L-Cx-R/L	F6	E		NF123..BM	B43
Cx-R/LF123	B25-B26, B38, B93	E..SCLCR/L -R	A124	P	
CXS..F..AR/L	B120	E..SDUCR/L	A125	PCLNR/L..HP	A201
CXS..F..BR/L	B120	E..STFCR/L-R	A126	PDJNR/L..HP	A203
CXS..FN	F33	E..STUCR/L..-GR	A127	PRDCN	A205
CXS-..R/L	F34	E..SVQCR/L -ER	A128	PRGCR/L	A205
CXS-A	F42, F44	E..SVUCR/L-ER	A128	PTGNR/L..HP	A209
CXS-Axx-X	F43	EF-xx	G3	PVJNR/L..HP	A211
Cx-SCLCR/L	A59-A60, A90-A91	F		Q	
Cx-SCMCN	A59-A60	F..SDUCR/L -ER	A129	QD-L	B53
Cx-SDJCR/L	A61-A62	F..STFCR/L-R	A130	QD-LL	B64, B67
Cx-SDNCN	A62	H		QD-LR	B64, B67
Cx-SDUCR/L	A92-A93, A99	HTxx..SLxxN/R/L	F26	QD-N	B52-B56
CXS-Exx-X	F43	HTxx-APBR/L..HP	F30	QD-N/R/L1..A	B65
Cx-SL..R/LF	F7	HTxx-ASHA..HP	F28	QD-N/R/L2..A	B65
Cx-SL-2C	F13	HTxx-ASHR/L	F28	QD-N/R/L2..C..A	B61
Cx-SL3C	F57-F58	HTxx-SLxxD	F61	QD-N/R/L2..C..D	B62
Cx-SL70-R/L	F14-F16	L		QD-NN1..A	B65
Cx-SL-D..E	F58	L123T3-CS	B90	QD-NN1..C..A	B61
Cx-SRDCN	A63-A65	L123U3-CS	B90	QD-NN2..A	B65
Cx-SRSCR/L	A63, A65	L123x1-RE (SF)	B23	QD-NN2..C..A	B61
Cx-SSKCR/L	A94	L123x1-RO (SF)	B21	QD-NR/L1..C..A	B61
Cx-STFCR/L	A95-A96	L123x1-RS (SF)	B24	QD-NR/L2..C..A	B61
Cx-SVHBR/L	A68, A70	L123x2-CF	B5	QD-NR1..C..D	B62
Cx-SVJBR/L	A66-A67, A70	L123x2-CM	B6	QD-NR2..D	B65
Cx-SVMBR/L	A69, A71	L123x2-CR	B7	QD-R...-CM	B53
Cx-SVQBR/L	A97-A98	L123x2-CS	B8	QD-R...-CO	B53
Cx-SVUBR/L..HP	A66	L166.0L	C45-C49	QD-R/LF..A	B59
Cx-SVVB	A68, A70	M		QD-R/LF..C..A	B58
CXS-xxB090..R/L	A271	M..Cx-390	D8	QD-R/LF..C..D	B58
CXS-xxG	B116-B119	MABR/L	A277	QD-R/LF..S	B59
CXS-xxR	B121	MACR/L	B97	QD-RL	B63, B66

	Código	Página	Código	Página	Código	Página
	QD-RR	B63, B66	R166.0L	C47-C50	SVHCR/L	A82
	QFT..-RM	B72	RC..X-SM	A246	SVJBR/L	A81, A83
	QFT-GF	B71	RCGX..E	A246	SVJBR/L-S	A83
	QFT-LG..C..B	B81	RCGX..K/T	A246	SVVBN	A82
	QFT-LG..C32..B	B75	RCGX-AL	A48	T	
B	QFT-RF..C..B	B79	RCMT	A48	TCEX..R/L-F	A51
	QFT-RF..C32..B	B77	RCMX	A165	TCGT-R/L-K	A52
	QFT-TF	B70	RNGA..S/T	A165	TCGT-UM	A53
	QFU..-RM	B72	RNGN	A245	TCGW	A54
	QFU-GF	B71	RNMG	A165	TCGX	A52-A53
	QFU-LF..C..B	B80	RPGN	A246	TCMT	A51-A53
	QFU-LF..C32..B	B78	RPGX	A246	TCMW	A54
	QFU-RG..C..B	B82	S		TCMX	A51-A52
	QFU-RG..C32..B	B76	S..CCLNR/L	A268	TNGA	A171
	QFU-TF	B70	S..CRSNR/L	A269	TNGN..S/T	A249
	QS-266R/LFA..C	C37	S..CRSPR/L	A269	TNMA-KR	A170
C	QS-3-80-LR/L	A19	SCACR/L-S	A73	TNMG	A169-A170
	QS-CP..AR/L	A13	SCGW	A50	TNMM	A170
	QS-CP..BR/L	A12	SCGX-AL	A49	TNMX	A169
	QS-PCLNR/L	A214	SCLCR/L	A72-A73	TPGN..S/T	A249
	QS-PDJNR/L	A215	SCMT	A49	TPUN..FP	A249
	QS-PSSNR/L	A216	SDJCR/L	A74-A75	TPUN..FR/LP	A249
	QS-QD-R/LF..C..D	B60	SDNCN	A75	TR-Cx-D13MCR/L	A24
	QS-R/LF123..C..E	B32	SL..NF	F40	TR-Cx-V13MBR/L	A27
	QS-R/LF123..C..E..-B	B40	SL-266R/LFG	C38	TR-D13JCR/L	A28
	QS-R/LF123..C..F	B32	SL-266R/LKF	C42	TR-D13NCN	A28
	QS-R/LG123..C..E..B	B40	SL-266R/LKF-QC	C43	TR-DC	A21
D	QS-SCLCR/L..C	A84	SL-2C	F37	TR-SL-D13JCR/L	A32
	QS-SDJCR/L..C	A85	SL70..RF	F51	TR-SL-D13UCR/L	A34-A35, A38
	QS-SMALR/L..X..HP	B99	SL70..RG	F51	TR-SL-D13XCR/L	A34-A35
	QS-SSDCR/L..C	A86	SL70-CRDCR/L	A259	TR-SL-V13JBR/L	A33
	QS-SVJBR/L..C	A87	SL70-CRSCR/L	A259	TR-SL-V13LBR/L	A36-A37
	QS-TR-D..JCN..HP	A30	SL70-R/L123	B44-B45	TR-SL-V13PBR/L	A37
	QS-TR-D..JCR/L..HP	A30	SL70-R/LG..C	B46	TR-V13JBR/L	A29
	QS-TR-V..N..HP	A31	SL70-SRDCR/L..HP	A138	TR-V13VBN	A29
	QS-TR-V..R/L..HP	A31	SL-CP..AR/L	A15	TR-VB	A22
	R		SL-CP..BR/L	A15	V	
	R/L166.0KF..B	C53	SL-CP-X..BR/L	A14	VBGT	A55
E	R/L166.0KF..E	C52	SL-PCLNR/L..HP	A226	VBGW	A57
	R/L176.9	A253	SL-PDUNR/L..HP	A229	VBMT	A55-A56
	R/L566.0KFC	C54	SL-PTFNR/L..HP	A234	VCET	A55
	R/LAF151.37	B111	SL-QC	F50	VCEX	A57
	R/LAG123..B	B48	SL-QD-R/LG..C	B68	VCGT	A55
	R/LAG123..B-R	B47	SL-QFT-L..C..A	B85	VCGX	A56
	R/LAG151.32	B109-B110	SL-QFT-R..C..A	B83	VCMT	A55
	R/LAG551.31	B108	SL-QFT-R..C..B	B83	VCMW	A57
	R/LAX123..B-020	B49	SL-QFU-L..C..A	B84	VDIxx..SLxxN	E6
	R/LF123..B	B29-B30	SL-QFU-L..C..B	B84	VDIxx..SLxxR/L	E6
	R/LF123..B..B	B39	SL-QFU-R..C..A	B86	VL80-NC3000	E10, E14
F	R/LF123..B1	B34	SL-SCLCR/L	A131, A133	VNGA	A173
	R/LF123..B-S	B31	SL-SCUCR/L	A145	VNGG	A172
	R/LF123..C	B35	SL-SDUCR/L	A134, A137, A146-A147	VNMG	A172
	R/LF123..C..E	B28	SL-SDXCR/L	A134, A137	W	
	R/LF123..D	B31	SL-STFCR/L	A139	WNGA	A176
	R/LF123T/U..BM	B94	SL-SVLBR/L	A141, A144, A150	WNGG	A174
	R/LF151.37	B105	SL-SVPBR/L	A141	WNMA	A175
	R/LG123..BM	B39	SNGA	A168	WNMG	A174-A175
	R/LG123..C	B35	SNGN	A247		
	R/LG123..CM	B35	SNGQ..S/T	A168		
	R/LG123..-GS	B14	SNMA-KR	A167		
G	R/LG123..-RO	B20	SNMG	A166-A167		
	R/LG123..-RS	B20	SNMM	A167		
	R/LG151.37	B105	SPGN..S/T	A248		
	R/LS151.22	B104	SPUN..FP	A248		
	R/LX123..B-007	B43	SRDCN	A76		
	R/LX123..B-045	B43	SRDCR/L	A76		
	R/LX123..B-070	B43	SRSCR/L	A76		
	R123T3-CS	B90	SSBCR/L	A78		
	R123U3-CS	B90	SSDCN	A78		
	R123x1-RE	B23	SSDCR/L	A77-A78		
	R123x1-RO	B21	STDRCR/L	A80		
H	R123x1-RS	B24	STFCR/L	A79		
	R123x2-CF	B5	STGCR/L	A79		
	R123x2-CM	B6	STJCR/L-S	A80		
	R123x2-CR	B7	STTCR/L	A80		
	R123x2-CS	B8	SVHBR/L	A82		